

Possible to set and change the time with front digit switches easily during the power off.



Furthermore single unit has a time range of 0.01s to 9990hrs!!

Features

- Possible to set and change the time and the time range even when the power is off.
- Selectable 8 different time ranges with front digit switches.
- Low price.
- [QM4H-S Type]
It can select the mode with MODE switch.
T.D. MODE: Time delay 2C (2 Form C)
INST. MODE: Time delay 1C (1 Form C)
Instantaneous 1C (1 Form C)
- [QM4H-G Type]
Reset and stop signal input enable to external control.
- Compliant with UL/c-UL and CE.



S Type
(with MODE switch)

G Type

RoHS Directive compatibility information
<http://www.nais-e.com/>

Product types

Product name	Time delay direction	Time range	Operating mode	Contact arrangement	Operating voltage	Part number
S Type QM4H digital timer	Addition	0.01s/0.1s/1s/0.1min/ 1min/0.1h/1h/10h (8 time ranges)	Power ON delay	T.D. mode: Time delay 2C INST. mode: Time delay 1C and Instantaneous 1C (Use MODE switch on front)	12 to 48 V AC/DC	QM4HS-U2C-48V
					100 to 240 V AC/DC	QM4HS-U2C-240V
G Type QM4H digital timer	Addition	0.01s/0.1s/1s/0.1min/ 1min/0.1h/1h/10h (8 time ranges)	Power ON delay (with reset and stop terminals)	Time delay 1C	12 to 48 V AC/DC	QM4HG-U1C-48V
					100 to 240 V AC/DC	QM4HG-U1C-240V

Note: Time delay directional subtraction types are also available by order

Part names

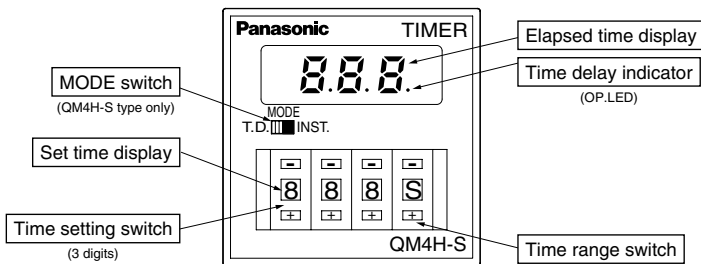

Time range settings

Time range switch	Operating time range
	0.01s to 9.99s
	0.1s to 99.9s
	1s to 999s
	0.1min. to 99.9min
	1min. to 999min
	0.1h to 99.9h
	1h to 999h
	10h to 9990h

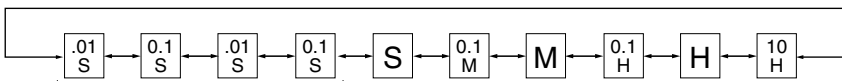

Note that there are two settings with the same range.

Changing the time setting

• It is possible to use the up and down keys to change the time setting even during timer delay.

However, attention should be paid to the following.

- 1) When the time setting is shorter than the elapsed time, and timer delay is set in the plus direction, the time setting will return to "0" after the timer delay reaches full-scale, timer delay will be performed up to the changed time setting, and time up will be reached.
- 2) When timer delay is set in the minus direction, timer delay will be performed up to "0" regardless of the time, even if the time setting is shorter than the elapsed time, and time up will be reached.

Specifications

Item		Type	QM4H-S		QM4H-G	
Rating	Rated operating voltage		12 to 48 V AC/DC and 100 to 240 V AC/DC			
	Rated power consumption	12 to 48 V AC/DC	During time delay	12 V DC, 48 V DC: Max. 1.5W 12 V AC, 48 V AC: Max. 3.0 VA	During time delay	12 V DC, 48 V DC: Max. 1.0W 12 V AC, 48 V AC: Max. 2.0 VA
			After time delay	12 V DC, 48 V DC: Max. 2.5W 12 V AC, 48 V AC: Max. 5.0 VA	After time delay	12 V DC, 48 V DC: Max. 1.5W 12 V AC, 48 V AC: Max. 3.5 VA
		100 to 240 V AC/DC	During time delay	100 V DC, 240 V DC: Max. 1.5W 100 V AC, 240 V AC: Max. 3.0 VA	During time delay	100 V DC, 240 V DC: Max. 1.0W 100 V AC, 240 V AC: Max. 2.5 VA
			After time delay	100 V DC, 240 V DC: Max. 2.0W 100 V AC, 240 V AC: Max. 4.0 VA	After time delay	100 V DC, 240 V DC: Max. 1.8W 100 V AC, 240 V AC: Max. 3.2 VA
	Rated frequency		50/60 Hz common (at AC)			
	Rated control capacity		5 A, 250V AC (resistive load)			
	Time range		0.01s to 9990h, Selection of 8 range: 0.01s/0.1s/1s/0.1min/1min/0.1h/1h/10h			
	Operation mode		Power ON delay		Power ON delay (with reset and stop terminals)	
	Min. input signal width		—		20ms (Reset and Stop inputs)*4	
Time accuracy*1	Operating time fluctuation		±(0.01%+0.05s) in case of power on start			
	Temperature error		±(0.005%+0.03s) in case of input reset start*2			
	Setting error		{ Operating voltage: 85 to 110% V Temperature: -10 to +55°C +14 to 131°F (20°C 68°F) Stopped time: 0.1 sec to 1 hour }			
	Voltage error					
Contact	Contact arrangement		T.D. mode: Time delay 2C INST. mode: Time delay 1C and Instantaneous 1C (Use MODE switch on front)		Time delay 1C	
	Contact material		Silver alloy			
Life*3	Mechanical (contact)		Min. 10 ⁷			
	Electrical (contact)		Min. 10 ⁵ (at rated control vltage)			
Electrical	Allowable operating voltage range		85 to 110% of rated operating voltage			
	Breakdown voltage (Initial value)		Between live and dead metal parts, between input and output, between contact sets, between contacts Min. 100 MΩ (at 500 V DC megger)			
	Insulation resistance (Initial value)		Between live and dead metal parts: 2, 000 Vrms for 1 min Between input and output: 2, 000 Vrms for 1 min Between contact sets: 2, 000 Vrms for 1 min Between contacts: 1, 000 Vrms for 1 min			
	Reset time		Max. 0.1s			
Mechanical	Vibration resistance	Functional	10 to 55 Hz: 1 cycle/min. single amplitude of 0.25 mm .010 inch (10 min on 3 axes)			
		Destructive	10 to 55 Hz: 1 cycle/min. single amplitude of 0.375 mm .015 inch (1h on 3 axes)			
	Shock resistance	Functional	98 m/s ² (4 times on 3 axes)			
		Destructive	980 m/s ² (5 times on 3 axes)			
Operating conditions	Ambient temperature		-10°C to 55°C +14°F to +131°F			
	Ambient humidity		Min. 35 to 85% RH (non-condensing)			
	Air pressure		860 to 1060 hPa			
Others	Mass (Weight)		Approx. 130 g 4.59 oz		Approx. 120 g 4.23 oz	
	Available standards		UL, c-UL, CE			
	Operating display		LED (red), During time delay: blinking, After time delay: OFF			

Notes: 1. Unspecified measuring conditions are rated operating voltage (in case of DC type, ripple rate of 5% or less), ambient temp. 20°C 68°F, and stop time 1 second.

2. Reset start applies to QM4H-G type.

3. Excluding switches

4. Note that if the QM4H-G type is set to zero "0" and a STOP signal is input, output will begin when the power is turned on.

5. The protective structure on the AQM4801 is IP50, and IP64 for the AQM4803.

QM4H

Applicable standard

Safety standard	EN61010-1	Pollution Degree 2/Overvoltage Category II
EMC	(EMI)EN61000-6-4 Radiation interference electric field strength Noise terminal voltage (EMS)EN61000-6-2 Static discharge immunity	EN55011 Group1 ClassA EN55011 Group1 ClassA
	RF electromagnetic field immunity	EN61000-4-2 4 kV contact 8 kV air EN61000-4-3 10 V/m AM modulation (80 MHz to 1 GHz) 10 V/m pulse modulation (895 MHz to 905 MHz)
EMC	EFT/B immunity	EN61000-4-4 2 kV (power supply line)
	Surge immunity	EN61000-4-5 1 kV (power line)
	Conductivity noise immunity	EN61000-4-6 10 V/m AM modulation (0.15 MHz to 80 MHz)
	Power frequency magnetic field immunity	EN61000-4-8 30 A/m (50 Hz)
	Voltage dip/Instantaneous stop/Voltage fluctuation immunity	EN61000-4-11 10 ms, 30% (rated voltage) 100 ms, 60% (rated voltage) 1,000 ms, 60% (rated voltage) 5,000 ms, 95% (rated voltage)

Dimensions

(units: mm inch)

Tolerance: $\pm 1.0 \pm 0.039$

• S Type

• G Type

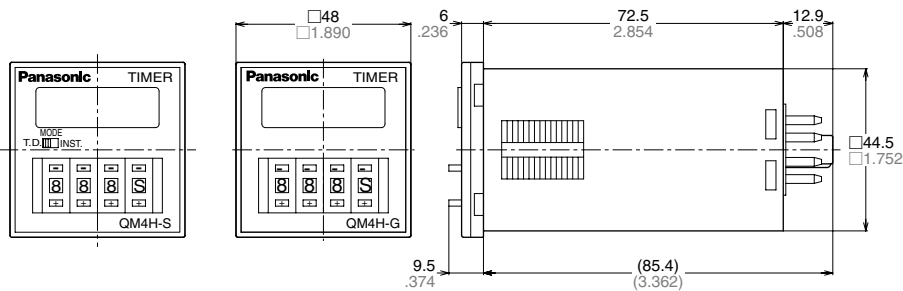

Terminal layouts and Wiring diagrams

• QM4H-S Type

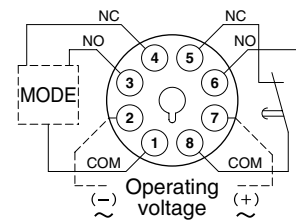

MODE

TD mode: Time delay 2C

T.D.

INST.

INST mode:

Time delay 1C and

Instantaneous 1C

*Use MODE switch on front

Notes:

1. Operating voltage signs in parentheses () indicate the polarity of the DC type.

2.  is a time delay contact.

 is an instantaneous contact.

Panel cut-out dimensions

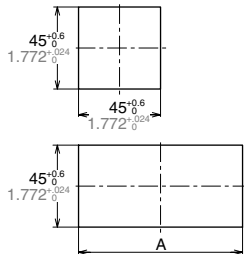

Dimensions A when n products are installed continuously:

$$A = (48 \times n - 2.5 \pm 0.6) \quad A = (1.890 \times n - .098 \pm 0.024)$$

Panel Mounting Diagram

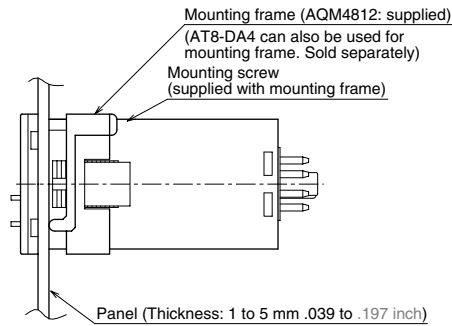

• QM4H-G Type

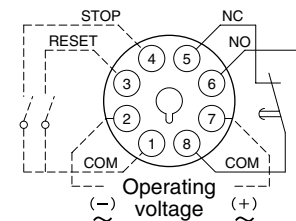

Operation mode

• QM4H-S Type

1) T.D. mode

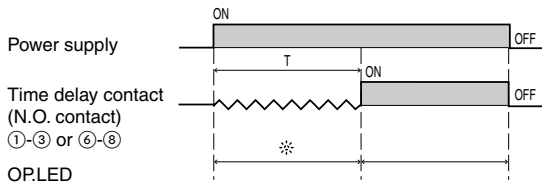

2) INST. mode

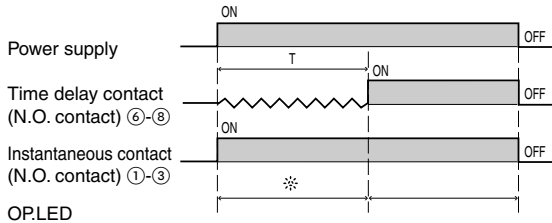

• QM4H-G Type

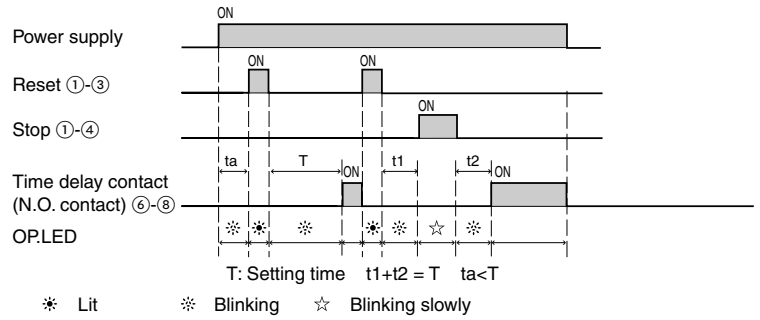

* Lit * Blinking ☆ Blinking slowly

- * Set the reset inputs ① to ③ and stop inputs ① to ④ to 20 ms or higher.
- * When shorting a signal, please set the inter-terminal resistance to 1 kΩ or less, and the inter-terminal residual voltage to 2 V or less. When releasing, please set the inter-terminal resistance to 100 kΩ or greater.

Precautions in using the QM4H

1. Avoid locations subject to flammable or corrosive gases, excessive dust, oil, vibrations, or excessive shocks.

2. Since the main-unit is made of polycarbonate resin, avoid contact with or use in environments containing methyl alcohol, benzene, thinners, and other organic solvents; and ammonia, caustic sodas, and other alkaline substances.

3. Power supply superimposed surge protector

Although a surge protector will withstand standard-waveform voltage with the values in the next table, anything above this will destroy the internal circuit. You should therefore use a surge absorber.

12 to 48 V AC/DC	100 to 240 V AC/DC
1,000 V	6,000 V

- Surge waveform
[±(1.2×50) μs uni-polar full wave voltage]

4. In order to maintain the characteristics, do not remove the timer case.

5. When installing the panel, use the supplied AQM4812 main-unit mounting frame. Note that the ATA4811 is also available for sale separately.

6. If you change the operating voltage, be sure not to allow leak current into the timer.

7. Avoid leaving the unit powered continuously. Leaving the unit powered up with output set to ON continuously for a long period of time (about 1 month or more) will wear out the electronic components. If you will be keeping it powered continuously, combine with a relay to create the circuit shown below:

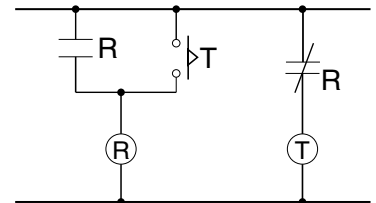

Compliance with the CE marking

• When using in applications to which EN61010-1/IEC61010-1 applies, abide by the following conditions.

- 1) Ambient conditions
- Overvoltage category II, pollution level 2
- Indoor use
- Acceptable temperature and humidity range: -10 to +55°C, 30 to 85%RH (with no condensation at 20°C)
- Under 2000 m elevation

2) Use the unit in a location that matches the following conditions.

- There is minimal dust and no corrosive gas.
- There is no combustible or explosive gas.
- There is no mechanical vibration or impacts.
- There is no exposure to direct sunlight.
- Located away from large-volume electromagnetic switches and power lines with large electrical currents.

3) Connect a breaker that conforms to EN60947-1 or EN60947-3 to the voltage input section.

4) Applied voltage should be protected with an overcurrent protection device (example: T 1A, 250 V AC time lag fuse) that conforms to the EN/IEC standards.