

# R13-553 ■■■ - ■■

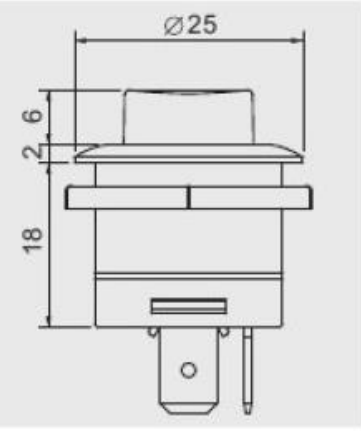

Cut-out

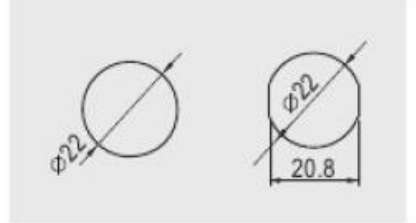

9.0 mm max

Cut-out for X2 BUTTON

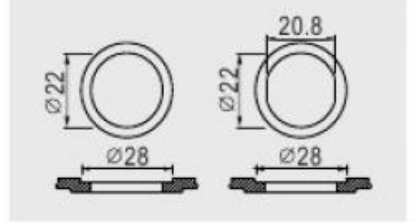

7.0 mm max

10A 14V DC  
5A 24V DC

## BUTTON

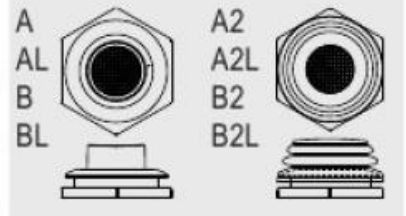

## FUNCTION

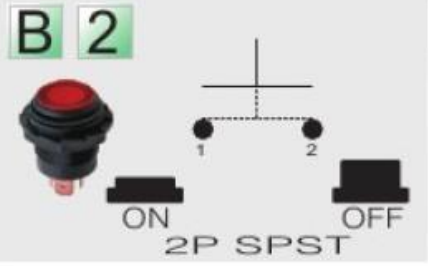
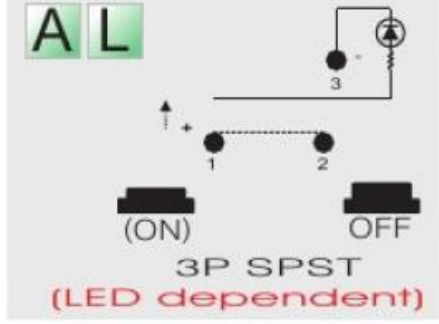
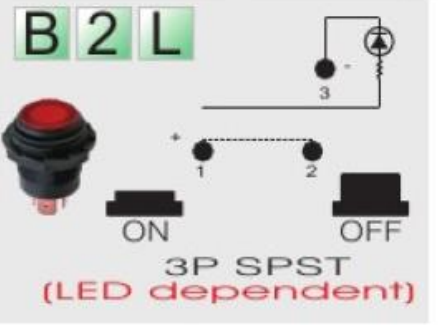
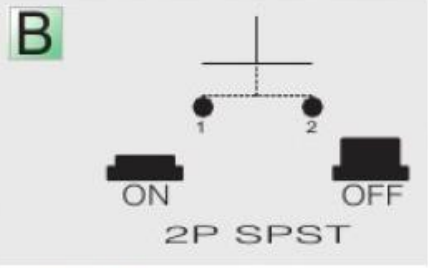
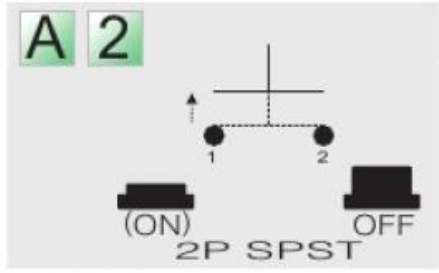
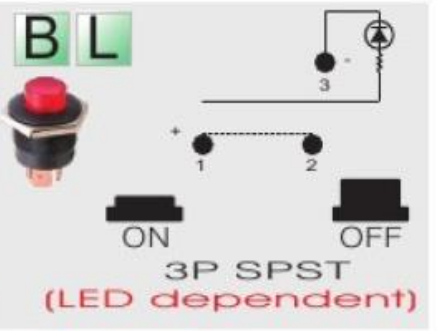
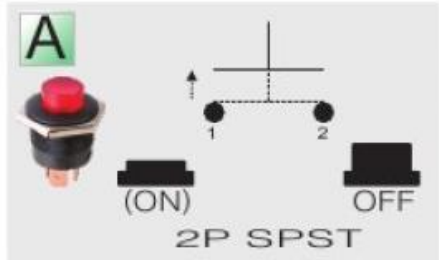

## TERMINAL

0 1 .250" SQ