

Datasheet SHT3x-ARP

Humidity and Temperature Sensor IC

- Fully calibrated, linearized, and temperature compensated analog output
- Wide supply voltage range, from 2.4 V to 5.5 V
- 10% to 90% ratiometric analog voltage output
- Typical accuracy of $\pm 2\%RH$ and $\pm 0.3^{\circ}C$
- Parallel measurement of temperature and humidity at separate pins
- Tiny 8-Pin DFN package



Product Summary

SHT3x-ARP is the next generation of Sensirion's temperature and humidity sensors. It builds on a new CMOSens® sensor chip that is at the heart of Sensirion's new humidity and temperature platform. The SHT3x-ARP has increased intelligence, reliability and improved accuracy specifications compared to its predecessor. Its functionality includes enhanced signal processing,

temperature and humidity can be read out at different pins. The DFN package has a footprint of 2.5 x 2.5 mm² while keeping a height of 0.9 mm. This allows for integration of the SHT3x-ARP into a great variety of applications. Additionally, the wide supply voltage range of 2.4 V to 5.5 V guarantees compatibility with diverse assembly situations. All in all, the SHT3x-ARP incorporates 15 years of knowledge of Sensirion, the leader in the humidity sensor industry.

Benefits of Sensirion's CMOSens® Technology

- High reliability and long-term stability
- Industry-proven technology with a track record of more than 15 years
- Designed for mass production
- High process capability
- High signal-to-noise ratio

Content

1	Sensor Performance.....	2
2	Specifications	4
3	Pin Assignment	6
4	Operation and Communication.....	7
5	Packaging.....	9
6	Shipping Package	11
7	Quality	12
8	Ordering Information.....	12
9	Further Information.....	12s

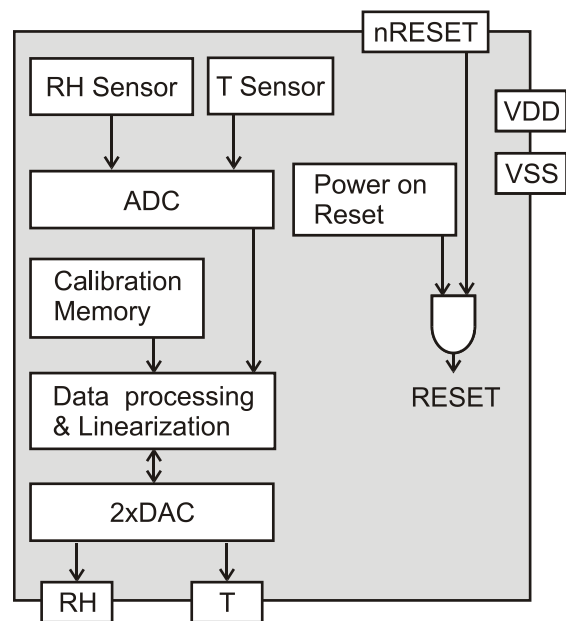

Figure 1 Functional block diagram of the SHT3x-ARP. The sensor signals for humidity and temperature are factory calibrated, linearized and compensated for temperature and supply voltage dependencies.

1 Sensor Performance

Humidity Sensor Specification

Parameter	Conditions	Value	Units
SHT30 Accuracy tolerance ¹	Typ.	±3	%RH
	Max.	Figure 2	-
SHT31 Accuracy tolerance ¹	Typ.	±2	%RH
	Max.	Figure 3	-
Repeatability ²		0.1	%RH
Resolution	Typ.	0.01	%RH
Integrated Non-Linearity ³	Typ.	0.2	%RH
Hysteresis	at 25°C	±0.8	%RH
Specified range ⁴	extended ⁵	0 to 100	%RH
Response time ⁶	$\tau_{63\%}$	8	s
Long-term drift	Typ. ⁷	<0.25	%RH/yr
Sensitivity	V _{DD} =2.4 V	19.2	mV/%RH
	V _{DD} =3.3V	26.4	mV/%RH
	V _{DD} =5.5V	44.0	mV/%RH

Table 1 Humidity sensor specification

Temperature Sensor Specification

Parameter	Condition	Value	Units
SHT30 Accuracy tolerance ¹	Typ., 0°C to 65°C	±0.3	°C
SHT31 Accuracy tolerance ¹	Typ., -40°C to 90°C	±0.3	°C
Repeatability ²		0.06	°C
Resolution	Typ.	0.015	°C
Specified Range	-	-40 to 125	°C
Response time ⁸	$\tau_{63\%}$	>2	s
Long Term Drift	Max.	<0.03	°C/yr
Sensitivity	V _{DD} =2.4 V	11.0	mV/°C
	V _{DD} =3.3V	15.1	mV/°C
	V _{DD} =5.5V	25.1	mV/°C

Table 2 Temperature sensor specification

¹ For definition of typical and maximum accuracy tolerance, please refer to the document "Sensirion Humidity Sensor Specification Statement".

² The stated repeatability is 3 times the standard deviation (3σ) of multiple consecutive measurements at constant ambient conditions. It is a measure for the noise on the physical sensor output. It is measured with analog circuit and integrated over 1 second.

³ Maximum deviation from the ideal shape (linear curve)

⁴ Specified range refers to the range for which the humidity or temperature sensor specification is guaranteed.

⁵ For details about recommended humidity and temperature operating range, please refer to section 1.1.

⁶ Time for achieving 63% of a humidity step function, valid at 25°C and 1m/s airflow. Humidity response time in the application depends on the design-in of the sensor.

⁷ Typical value for operation in normal RH/T operating range, see section 1.1. Maximum value is < 0.5 %RH/yr. Value may be higher in environments with vaporized solvents, out-gassing tapes, adhesives, packaging materials, etc. For more details please refer to Handling Instructions.

⁸ Temperature response times strongly depends on the design-in of the sensor in the final application. Minimal response time can be achieved when the thermalized sensor at T1 is placed on a well conducting surface with temperature T2.

Humidity Sensor Performance Graphs

SHT30

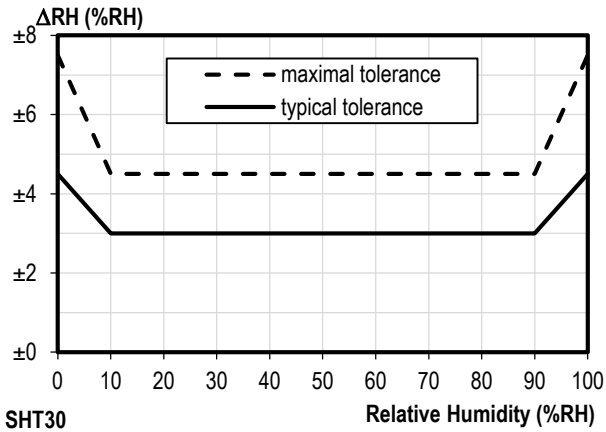

Figure 2 Tolerance of RH at 25°C for SHT30

SHT31

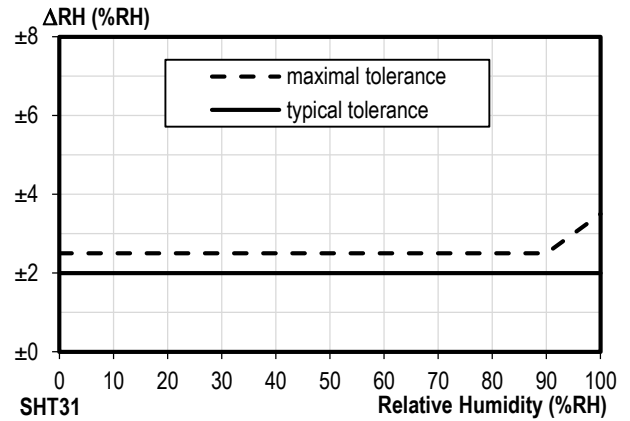

Figure 3 Tolerance of RH at 25°C for SHT31

SHT30

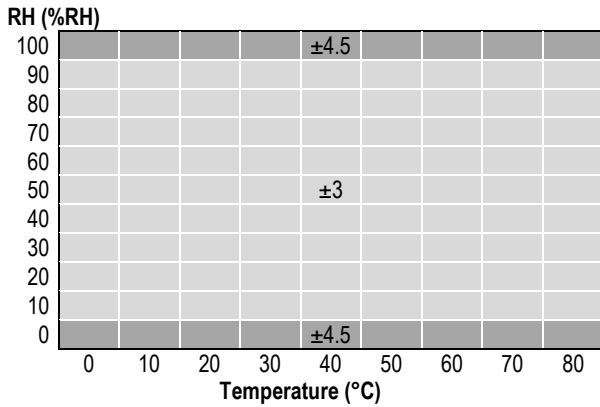

Figure 4 Typical tolerance of RH over T for SHT30

SHT31

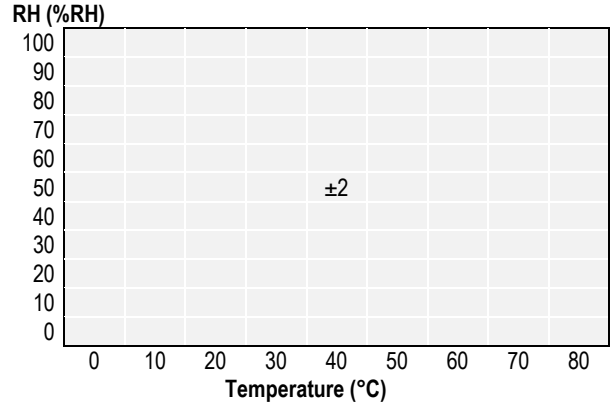

Figure 5 Typical tolerance of RH over T for SHT31

Temperature Sensor Performance Graphs

SHT30

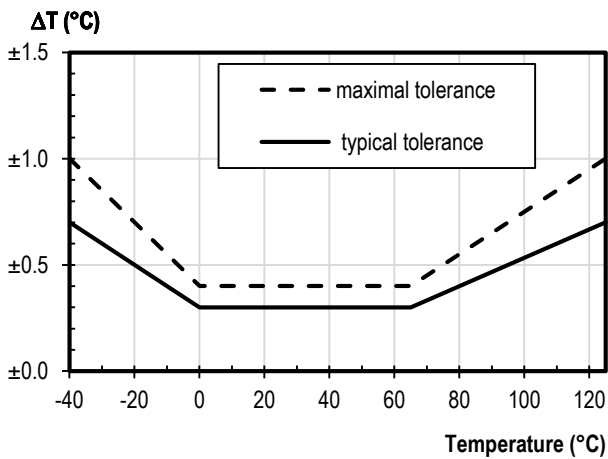

Figure 6 Temperature accuracy of the SHT30 sensor.

SHT31

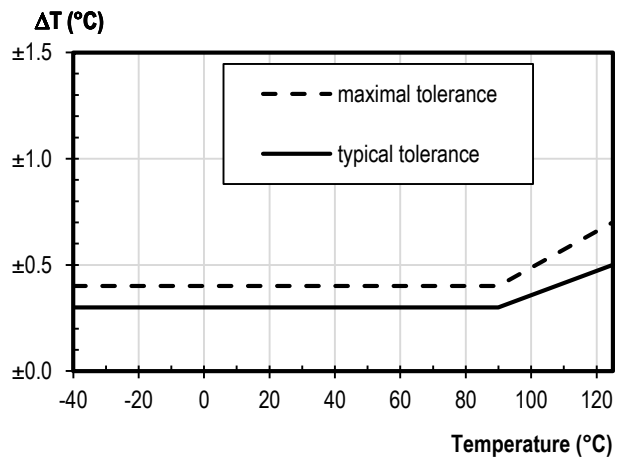

Figure 7 Temperature accuracy of the SHT31 sensor.

1.1 Recommended Operating Condition

The sensor shows best performance when operated within recommended normal temperature and humidity range of 5 – 60 °C and 20 – 80 %RH, respectively. Long term exposure to conditions outside normal range, especially at high humidity, may temporarily offset the RH signal (e.g. +3%RH after 60h at >80%RH). After returning into the normal temperature and humidity range the sensor will slowly come back to calibration state by itself. Prolonged exposure to extreme conditions may accelerate ageing. To ensure stable operation of the humidity sensor, the conditions described in the document “SHTxx Assembly of SMD Packages”, section “Storage and Handling Instructions” regarding exposure to volatile organic compounds have to be met. Please note as well that this does apply not only to transportation and manufacturing, but also to operation of the SHT3x-ARP.

2 Specifications

2.1 Electrical Specifications

Parameter	Symbol	Condition	Min	Typ.	Max	Units	Comments
Supply voltage	V _{DD}		2.4	3.3	5.5	V	
Power-up/down level	V _{POR}		2.1	2.3	2.4	V	
Slew rate change of the supply voltage	V _{DD,slew}		-	-	20	V/ms	Voltage changes on the VDD line between V _{DD,min} and V _{DD,max} should be slower than the maximum slew rate; faster slew rates may lead to reset
Supply current	I _{DD}	Average	-	220	350	µA	At a measurement rate of 2 Hz. Depends on the resistive load on the output pins
Output current	A _{O_IOUT}		-100	-	100	µA	
Capacitive load	C _L		-	-	5	nF	Capacitance that can be driven by the sensor on the signal lines

Table 3 Electrical specifications, valid at 25°C.

2.2 Timing Specification for the Sensor System

Parameter	Symbol	Conditions	Min.	Typ.	Max.	Units	Comments
Power-up time	t _{PU}	After hard reset, V _{DD} ≥ V _{POR}	-	-	17	ms	Time between V _{DD} reaching V _{POR} and first measurement signal available
Analog output settling time	A _{O_{settle}}	For a step of VDD/2	-	0.3		ms	Time needed for adapting to a changing supply voltage and measurement value. Value depends on output load. Typical value is for a load of 1nF.
Duration of reset pulse	t _{RESETN}		350	-	-	ns	See section 3.3

Table 4 System Timing Specification, valid from -40 °C to 125 °C and 2.4 V to 5.5 V.

2.3 Absolute Minimum and Maximum Ratings

Stress levels beyond those listed in Table 5 may cause permanent damage to the device or affect the reliability of the sensor. These are stress ratings only and functional operation of the device at these conditions is not guaranteed.

Parameter	Rating	Units
Supply voltage V_{DD}	-0.3 to 6	V
Max Voltage on pins (pin 1 (RH); pin 2 (R); pin 3 (R); pin 4(T); pin 6 (nRESET))	-0.3 to $V_{DD}+0.3$	V
Input current on any pin	± 100	mA
Operating temperature range	-40 to 125	$^{\circ}\text{C}$
Storage temperature range	-40 to 150	$^{\circ}\text{C}$
ESD HBM (human body model) ⁹	4	kV
ESD CDM (charge device model) ¹⁰	750	V

Table 5 Minimum and maximum ratings; values may only be applied for short time periods.

⁹ Sensor in application configuration (pin 7 connected to VSS). ESD HBM 2 kV according to JEDEC JS-001.

¹⁰ According to JEDEC JS-002.

3 Pin Assignment

The SHT3x-ARP comes in a tiny 8-pin DFN package – see Table 6.

Pin	Name	Comments
1	RH	Analog voltage out; output
2	R	No electrical function; recommended to connect to VSS
3	R	No electrical function; recommended to connect to VSS
4	T	Analog voltage out; output
5	VDD	Supply voltage; input
6	nRESET	Reset pin active low; Input; if not used it is recommended to connect to VDD
7	R	No electrical function; to be connected to VSS
8	VSS	Ground

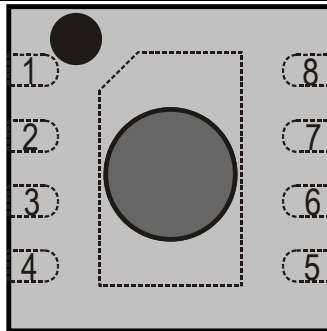

Table 6 SHT3x-ARP pin assignment (transparent top view). Dashed lines are only visible if viewed from below. The die pad is internally connected to VSS.

3.1 Power Pins (VDD, VSS)

The electrical specifications of the SHT3x-ARP are shown in Table 3. The power supply pins must be decoupled with a 100 nF capacitor that shall be placed as close to the sensor as possible – see Figure 8 for a typical application circuit.

3.2 Temperature and Humidity Pin

The physical output of temperature and humidity can be read out at separated pins, as shown in Table 6. Data is supplied as ratiometric voltage output. The specification of the analog voltage signal and its conversion to physical values is explained in Section 4.

3.3 nRESET Pin

The nReset pin may be used to generate a reset of the sensor. A minimum pulse duration of 350 ns is required to reliably trigger a reset of the sensor. If not used it is recommended to connect to VDD.

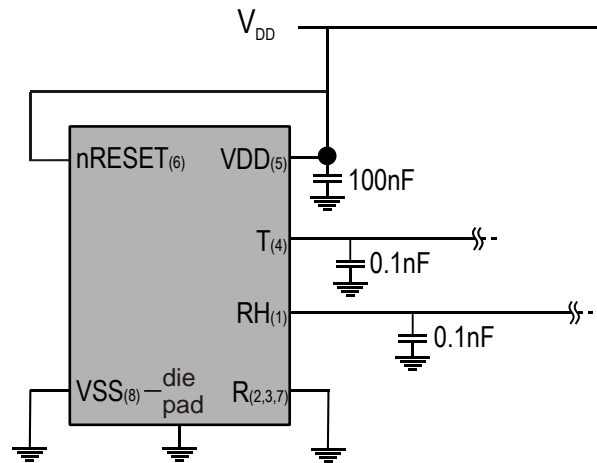

Figure 8 Typical application circuit. Please note that the positioning of the pins does not reflect the position on the real sensor. This is shown in Table 6.

3.4 Die Pad (center pad)

The die pad or center pad is visible from below and located in the center of the package. It is electrically connected to VSS. Hence electrical considerations do not impose constraints on the wiring of the die pad. However, due to mechanical reasons it is recommended to solder the center pad to the PCB. For more information on design-in, please refer to the document “SHTxx Design Guide”.

4 Operation and Communication

4.1 Start-up of the sensor

The sensor starts up after reaching the power-up threshold voltage V_{POR} specified in Table 3. After reaching this threshold voltage the sensor needs the time t_{PU} until the first measurement signal is available as voltage output on the respective output pins. During that time the temperature and humidity pins have an undefined state.

4.2 Conversion of the Signal Output

The physical values as measured by the sensor are mapped to a ratiometric voltage output (V_x , $x=T, RH$ as 10 to 90% of V_{DD}). Prior to conversion into a voltage signal, the physical values are linearized and compensated for temperature and supply voltage effects by the sensor. Additionally, the voltage output is calibrated for each sensor. Hence the relationship between temperature and humidity and the voltage output is the same for each sensor, within the limits given by the accuracy (Table 1 and Table 2).

This allows to describe the relationship between physical values (RH and T) and the voltage output for temperature and humidity (V_x , $x=T, RH$) through a generic linear formula given by equations (1), (2) and (3); its graphical representation can be found in Figure 9 & Figure 10.

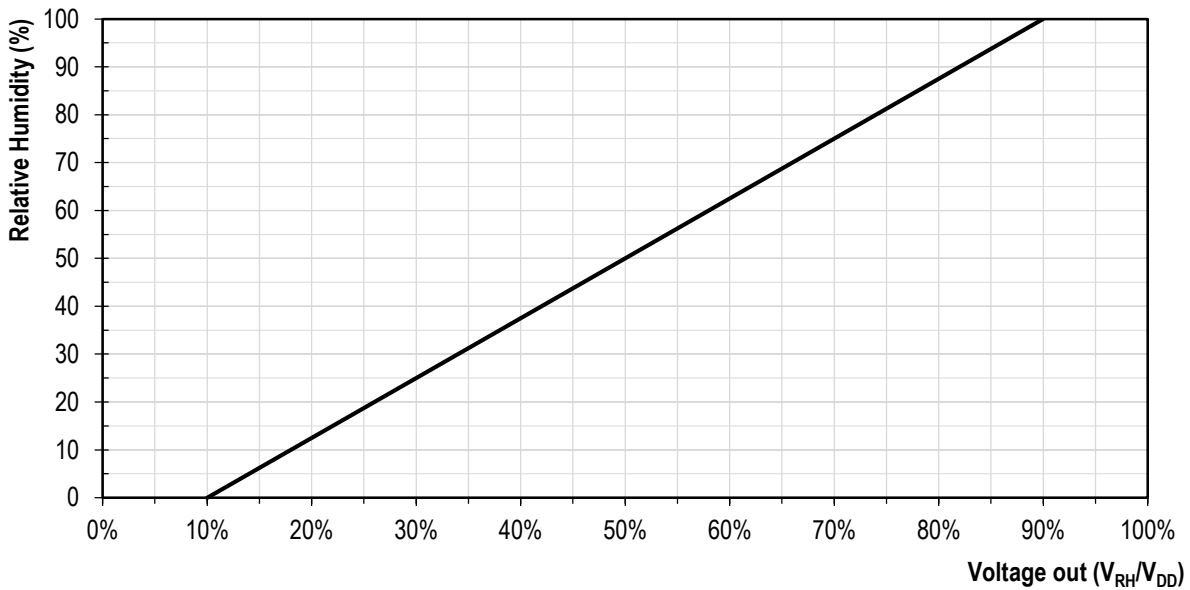

Figure 9 Relationship between the ratiometric analog voltage output and the measured relative humidity.

$$RH = -12.5 + 125 \cdot \frac{V_{RH}}{V_{DD}} = -\frac{10}{0.8} + \frac{100}{0.8} \cdot \frac{V_{RH}}{V_{DD}} \quad (1)$$

Equation (1) describes the conversion formula for the RH signal.

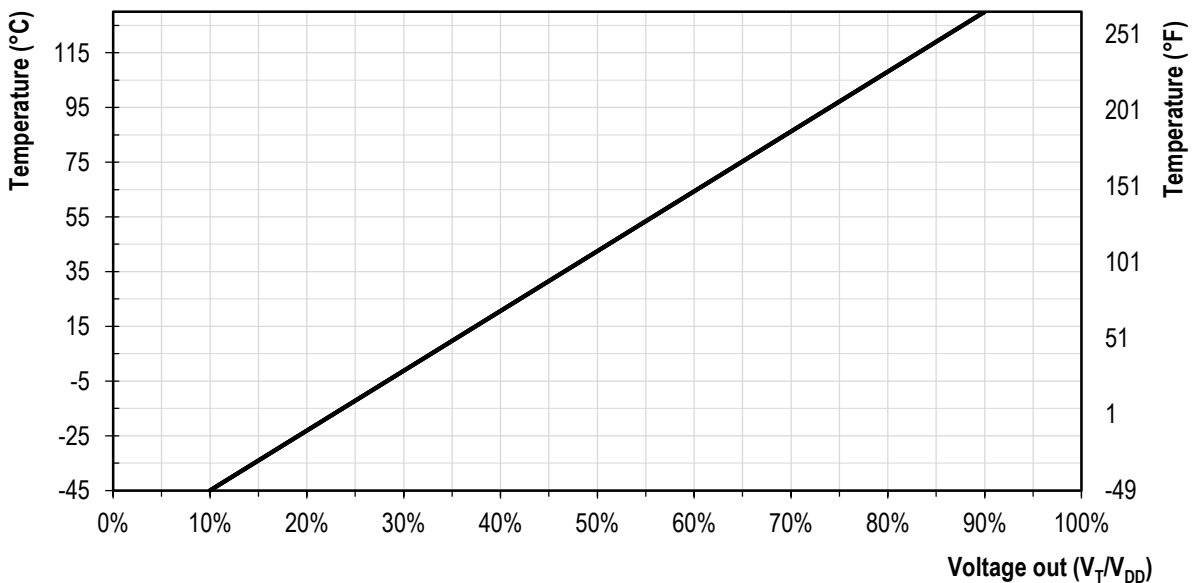

Figure 10 Relationship between the ratiometric analog voltage output and the measured temperature

$$T [^{\circ}C] = -66.875 + 218.75 \cdot \frac{V_T}{V_{DD}} = -45 - \frac{17.5}{0.8} + \frac{175}{0.8} \cdot \frac{V_T}{V_{DD}} \quad (2)$$

$$T [^{\circ}F] = -88.375 + 393.75 \cdot \frac{V_T}{V_{DD}} = -49 - \frac{31.5}{0.8} + \frac{315}{0.8} \cdot \frac{V_T}{V_{DD}} \quad (3)$$

Equations (2) and (3) describe the conversion formulae for the temperature signal in °C and °F.

5 Packaging

SHT3x-ARP sensors are provided in an open-cavity DFN package. DFN stands for dual flat no leads. The humidity sensor opening is centered on the top side of the package.

The sensor chip is made of silicon and is mounted to a lead frame. The latter is made of Cu plated with Ni/Pd/Au. Chip and lead frame are overmolded by an epoxy-based mold compound leaving the central die pad and I/O pins exposed for mechanical and electrical connection. Please note that the side walls of the sensor are diced and therefore these diced lead frame surfaces are not covered with the respective plating.

The package (except for the humidity sensor opening) follows JEDEC publication 95, design registration 4.20, small scale plastic quad and dual inline, square and rectangular, No-LEAD packages (with optional thermal enhancements) small scale (QFN/SON), Issue D.01, September 2009.

5.1 Traceability

All SHT3x-ARP sensors are laser marked for easy identification and traceability. The marking on the sensor top side consists of a pin-1 indicator and two lines of text.

The top line consist of the pin-1 indicator which is located in the top left corner and the product name. The small letter x stands for the accuracy class.

The bottom line consists of 6 letters. The first two digits XY (=AR) describe the output mode. The third letter (A) represents the manufacturing year (4 = 2014, 5 = 2015, etc). The last three digits (BCD) represent an alphanumeric tracking code. That code can be decoded by Sensirion only and allows for tracking on batch level through production, calibration and testing – and will be provided upon justified request.

If viewed from below pin 1 is indicated by triangular shaped cut in the otherwise rectangular die pad. The dimensions of the triangular cut are shown in Figure 12 through the labels T1 & T2.

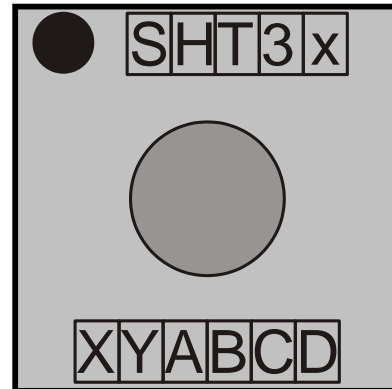

Figure 11 Top View of the SHT3x-ARP illustrating the laser marking.

5.2 Package Outline

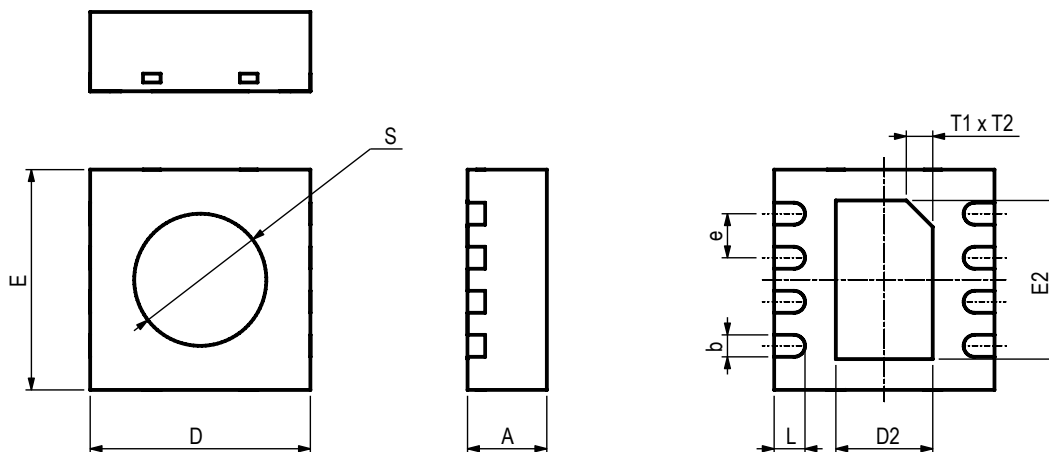

Figure 12 Dimensional drawing of SHT3x-ARP sensor package.

Parameter	Symbol	Min	Nom.	Max	Units	Comments
Package height	A	0.8	0.9	1	mm	
Leadframe height	A3	-	0.2	-	mm	Not shown in the drawing
Pad width	b	0.2	0.25	0.3	mm	
Package width	D	2.4	2.5	2.6	mm	
Center pad length	D2	1	1.1	1.2	mm	
Package length	E	2.4	2.5	2.6	mm	
Center pad width	E2	1.7	1.8	1.9	mm	
Pad pitch	e	-	0.5	-	mm	
Pad length	L	0.3	0.35	0.4	mm	
Max cavity	S	-	-	1.5	mm	Only as guidance. This value includes all tolerances, including displacement tolerances. Typically the opening will be smaller.
Center pad marking	T1xT2		0.3x45°		mm	indicates the position of pin 1

Table 7 Package outline

5.3 Land Pattern

Figure 13 shows the land pattern. The land pattern is understood to be the open metal areas on the PCB, onto which the DFN pads are soldered.

The solder mask is understood to be the insulating layer on top of the PCB covering the copper traces. It is recommended to design the solder mask as a Non-Solder Mask Defined (NSMD) type. For NSMD pads, the solder mask opening should provide a 60 µm to 75 µm design clearance between any copper pad and solder mask. As the pad pitch is only 0.5 mm we recommend to have one solder mask opening for all 4 I/O pads on one side.

For solder paste printing it is recommended to use a laser-cut, stainless steel stencil with electro-polished trapezoidal walls and with 0.1 or 0.125 mm stencil thickness. The length of the stencil apertures for the I/O pads should be the same as the PCB pads. However, the position of the stencil apertures should have an offset of 0.1 mm away from the center of the package. The die pad aperture should cover about 70 – 90 % of the die pad area –thus it should have a size of about 0.9 mm x 1.6 mm.

For information on the soldering process and further recommendation on the assembly process please consult the Application Note HT_AN_SHTxx_Assembly_of_SMD_Packages, which can be found on the Sensirion webpage.

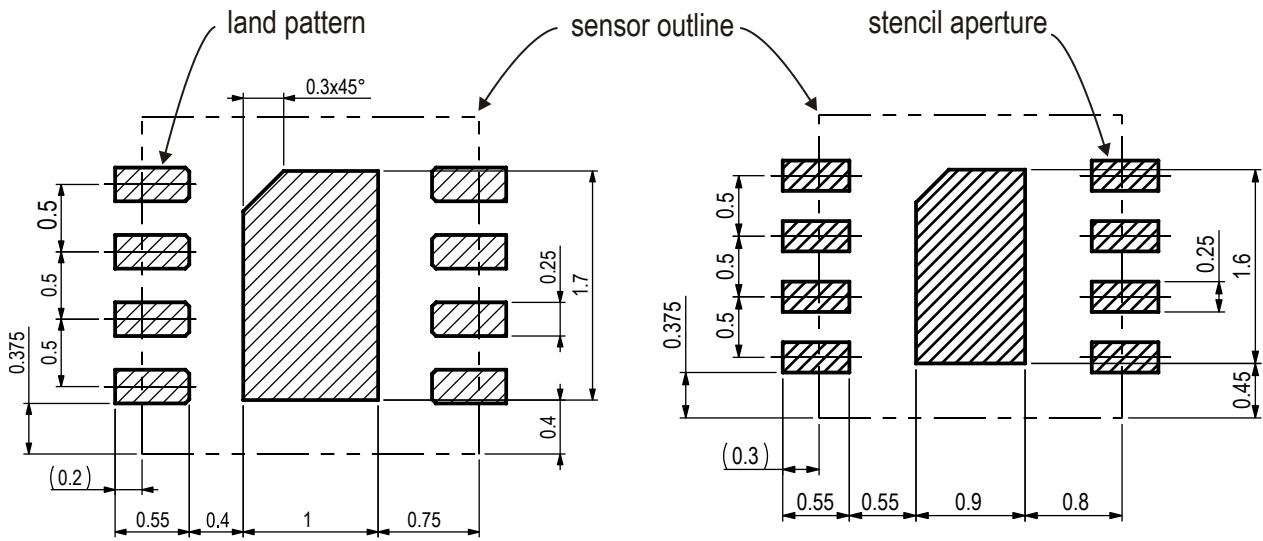

Figure 13 Recommended metal land pattern (left) and stencil apertures (right) for the SHT3x-ARP. The dashed lines represent the outer dimension of the DFN package. The PCB pads (left) and stencil apertures (right) are indicated through the shaded areas.

6 Shipping Package

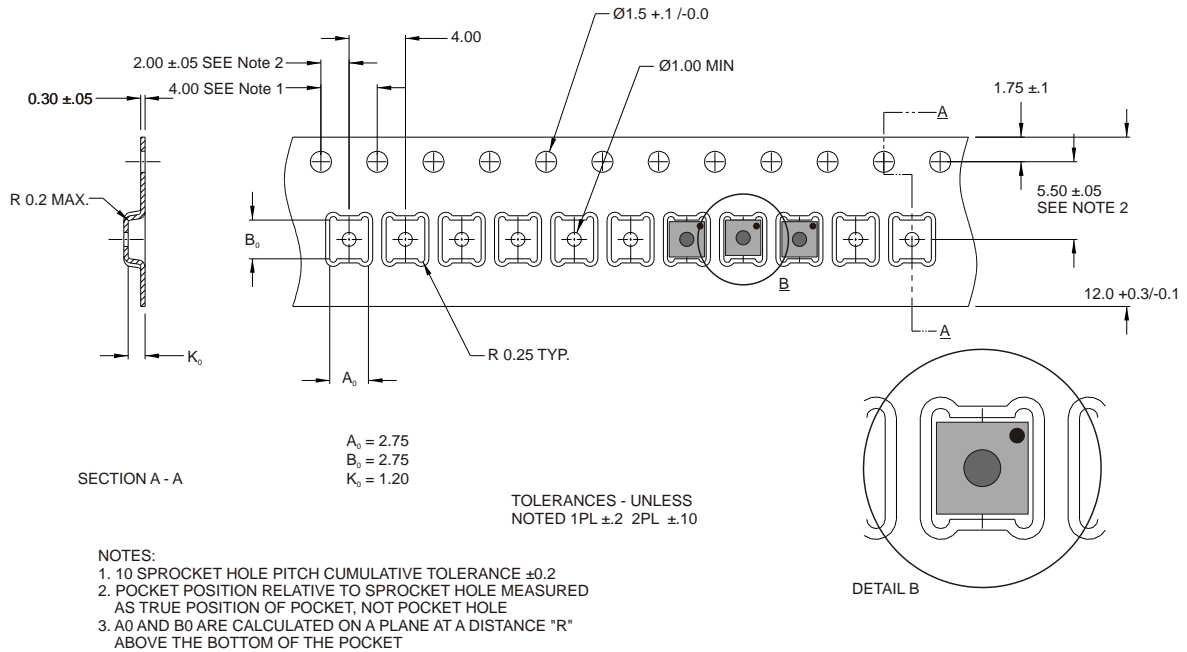

Figure 14 Technical drawing of the packaging tape with sensor orientation in tape. Header tape is to the right and trailer tape to the left on this drawing. Dimensions are given in millimeters.

7 Quality

Qualification of the SHT3x-ARP is performed based on the AEC Q 100 qualification test method.

7.1 Material Contents

The device is fully RoHS and WEEE compliant, e.g. free of Pb, Cd, and Hg.

8 Ordering Information

The SHT3x-ARP can be ordered in tape and reel packaging with different sizes, see Table 8. The reels are sealed into antistatic ESD bags. The document “SHT3x shipping package” that shows the details about the shipping package is available upon request.

Name	Quantity	Order Number
SHT30-ARP-B2.5kS	2500	1-101381-01
SHT30-ARP-B10kS	10000	1-101175-01
SHT31-ARP-B2.5kS	2500	1-101385-01
SHT31-ARP-B10kS	10000	1-101178-01

Table 8 SHT3x-ARP ordering options.

9 Further Information

For more in-depth information on the SHT3x-ARP and its application please consult the following documents:

Document Name	Description	Source
SHT3x Shipping Package	Information on Tape, Reel and shipping bags (technical drawing and dimensions)	Available upon request
SHTxx Assembly of SMD Packages	Assembly Guide (Soldering Instruction,)	Available for download at the Sensirion humidity sensors download center: www.sensirion.com/humidity-download
SHTxx Design Guide	Design guidelines for designing SHTxx humidity sensors into applications	Available for download at the Sensirion humidity sensors download center: www.sensirion.com/humidity-download
SHTxx Handling Instructions	Guidelines for proper handling of SHTxx humidity sensors (Reconditioning Procedure)	Available for download at the Sensirion humidity sensors download center: www.sensirion.com/humidity-download
Sensirion Humidity Sensor Specification Statement	Definition of sensor specifications.	Available for download at the Sensirion humidity sensors download center: www.sensirion.com/humidity-download

Table 9 Documents containing further information relevant for the SHT3x-ARP.

Revision History

Date	Version	Page(s)	Changes
October 2015	1		Initial release
January 2016	2	12	Update ordering information

Important Notices

Warning, Personal Injury

Do not use this product as safety or emergency stop devices or in any other application where failure of the product could result in personal injury. Do not use this product for applications other than its intended and authorized use. Before installing, handling, using or servicing this product, please consult the data sheet and application notes. Failure to comply with these instructions could result in death or serious injury.

If the Buyer shall purchase or use SENSIRION products for any unintended or unauthorized application, Buyer shall defend, indemnify and hold harmless SENSIRION and its officers, employees, subsidiaries, affiliates and distributors against all claims, costs, damages and expenses, and reasonable attorney fees arising out of, directly or indirectly, any claim of personal injury or death associated with such unintended or unauthorized use, even if SENSIRION shall be allegedly negligent with respect to the design or the manufacture of the product.

ESD Precautions

The inherent design of this component causes it to be sensitive to electrostatic discharge (ESD). To prevent ESD-induced damage and/or degradation, take customary and statutory ESD precautions when handling this product.

See application note "ESD, Latchup and EMC" for more information.

Warranty

SENSIRION warrants solely to the original purchaser of this product for a period of 12 months (one year) from the date of delivery that this product shall be of the quality, material and workmanship defined in SENSIRION's published specifications of the product. Within such period, if proven to be defective, SENSIRION shall repair and/or replace this product, in SENSIRION's discretion, free of charge to the Buyer, provided that:

- notice in writing describing the defects shall be given to SENSIRION within fourteen (14) days after their appearance;

- such defects shall be found, to SENSIRION's reasonable satisfaction, to have arisen from SENSIRION's faulty design, material, or workmanship;
- the defective product shall be returned to SENSIRION's factory at the Buyer's expense; and
- the warranty period for any repaired or replaced product shall be limited to the unexpired portion of the original period.

This warranty does not apply to any equipment which has not been installed and used within the specifications recommended by SENSIRION for the intended and proper use of the equipment. EXCEPT FOR THE WARRANTIES EXPRESSLY SET FORTH HEREIN, SENSIRION MAKES NO WARRANTIES, EITHER EXPRESS OR IMPLIED, WITH RESPECT TO THE PRODUCT. ANY AND ALL WARRANTIES, INCLUDING WITHOUT LIMITATION, WARRANTIES OF MERCHANTABILITY OR FITNESS FOR A PARTICULAR PURPOSE, ARE EXPRESSLY EXCLUDED AND DECLINED.

SENSIRION is only liable for defects of this product arising under the conditions of operation provided for in the data sheet and proper use of the goods. SENSIRION explicitly disclaims all warranties, express or implied, for any period during which the goods are operated or stored not in accordance with the technical specifications.

SENSIRION does not assume any liability arising out of any application or use of any product or circuit and specifically disclaims any and all liability, including without limitation consequential or incidental damages. All operating parameters, including without limitation recommended parameters, must be validated for each customer's applications by customer's technical experts. Recommended parameters can and do vary in different applications. SENSIRION reserves the right, without further notice, (i) to change the product specifications and/or the information in this document and (ii) to improve reliability, functions and design of this product.

Copyright © 2016, by SENSIRION.
CMOSens® is a trademark of Sensirion
All rights reserved

Headquarters and Subsidiaries

Sensirion AG
Laubisruetistr. 50
CH-8712 Staefa ZH
Switzerland

Phone: +41 44 306 40 00
Fax: +41 44 306 40 30
info@sensirion.com
www.sensirion.com

Sensirion Inc., USA
Phone: +1 805 409 4900
info_us@sensirion.com
www.sensirion.com

Sensirion Japan Co. Ltd.
Phone: +81 3 3444 4940
info@sensirion.co.jp
www.sensirion.co.jp

Sensirion Korea Co. Ltd.
Phone: +82 31 337 7700~3
info@sensirion.co.kr
www.sensirion.co.kr

Sensirion China Co. Ltd.
Phone: +86 755 8252 1501
info@sensirion.com.cn
www.sensirion.com.cn

To find your local representative, please visit www.sensirion.com/contact

X-ON Electronics

Largest Supplier of Electrical and Electronic Components

Click to view similar products for [Industrial Humidity Sensors](#) category:

Click to view products by [Sensirion](#) manufacturer:

Other Similar products are found below :

[238169190001](#) [HTUF3535PVBM](#) [01411.2-00](#) [01420.2-00](#) [HIH8130-021-001](#) [TH06](#) [HIH-4000-003](#) [3.000.074](#) [1-100726-01](#) [1-100706-01](#) [1-101461-01](#) [1-101385-01](#) [1-101386-01](#) [1-101484-01](#) [1-101415-01](#) [1-100811-01](#) [T9602-3-A](#) [HIH6021-021-001](#) [HIH6031-000-001](#) [2JCIE-BL01](#) [SHT31-DIS-F2.5kS](#) [I2C-HUTMP](#) [P40254276](#) [T8700-E](#) [HUMI-DP-XR-S](#) [AR250/U](#) [1-100707-01](#) [1-100769-01](#) [1-101466-01](#) [1-101388-01](#) [1-101465-01](#) [1-101110-01](#) [SY-DS-1L](#) [AR250/I](#) [AR252/LCD/U](#) [RC-SPC1K](#) [MB-AHT-1](#) [AR252/LCD/I](#) [AR281](#) [T8700](#) [T9602-3-A-1](#) [T9602-3-D](#) [T9602-3-D-1](#) [T9602-5-A](#) [T9602-5-A-1](#) [T9602-5-D](#) [T9602-5-D-1](#) [HDS10](#) [AR252/I](#) [AR252/RS485](#)