

628 - 2 Z

SKF Explorer

Dimensions

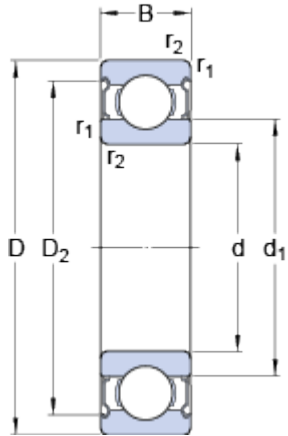

d	8	mm
D	24	mm
B	8	mm
d ₁	≈ 14.45	mm
D ₂	≈ 21.2	mm
r _{1,2}	min. 0.3	mm

Abutment dimensions

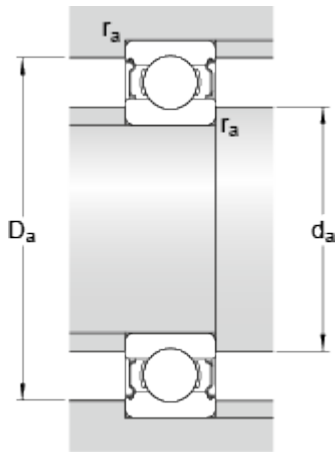

d _a	min. 10.4	mm
d _a	max. 14.4	mm
D _a	max. 21.6	mm
r _a	max. 0.3	mm

Calculation data

Basic dynamic load rating	C	3.9	kN
Basic static load rating	C ₀	1.66	kN
Fatigue load limit	P _u	0.071	kN
Reference speed		63000	r/min
Limiting speed		32000	r/min
Calculation factor	k _r	0.025	
Calculation factor	f ₀	13	

Mass

Mass bearing	0.018	kg
--------------	--------------	----

