

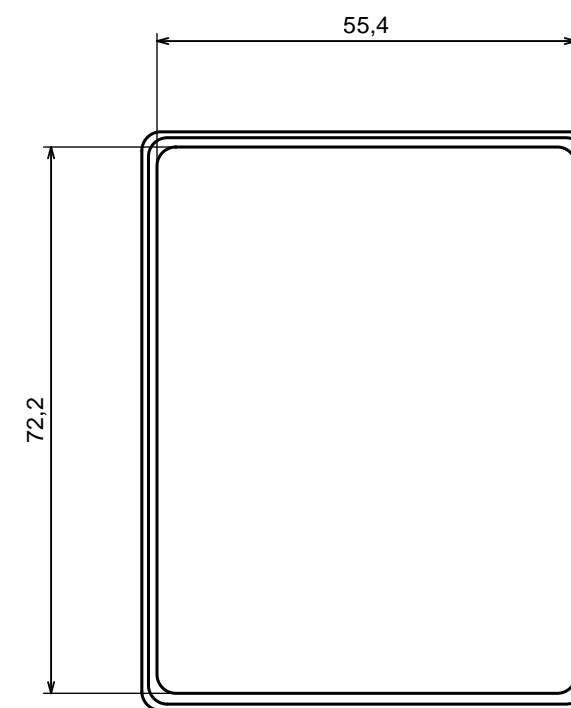

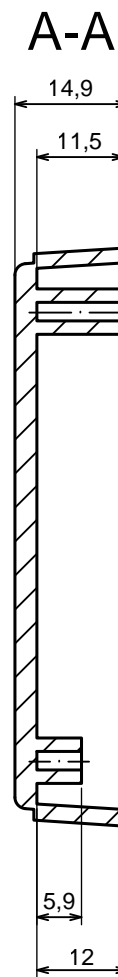

All rights reserved, Copyright Kradox 2016		
Product model	Enclosure Z71- assembly	
Format: A3	Material: PS, ABS	
Scale 1:1	Tolerance: +/- 0.5	

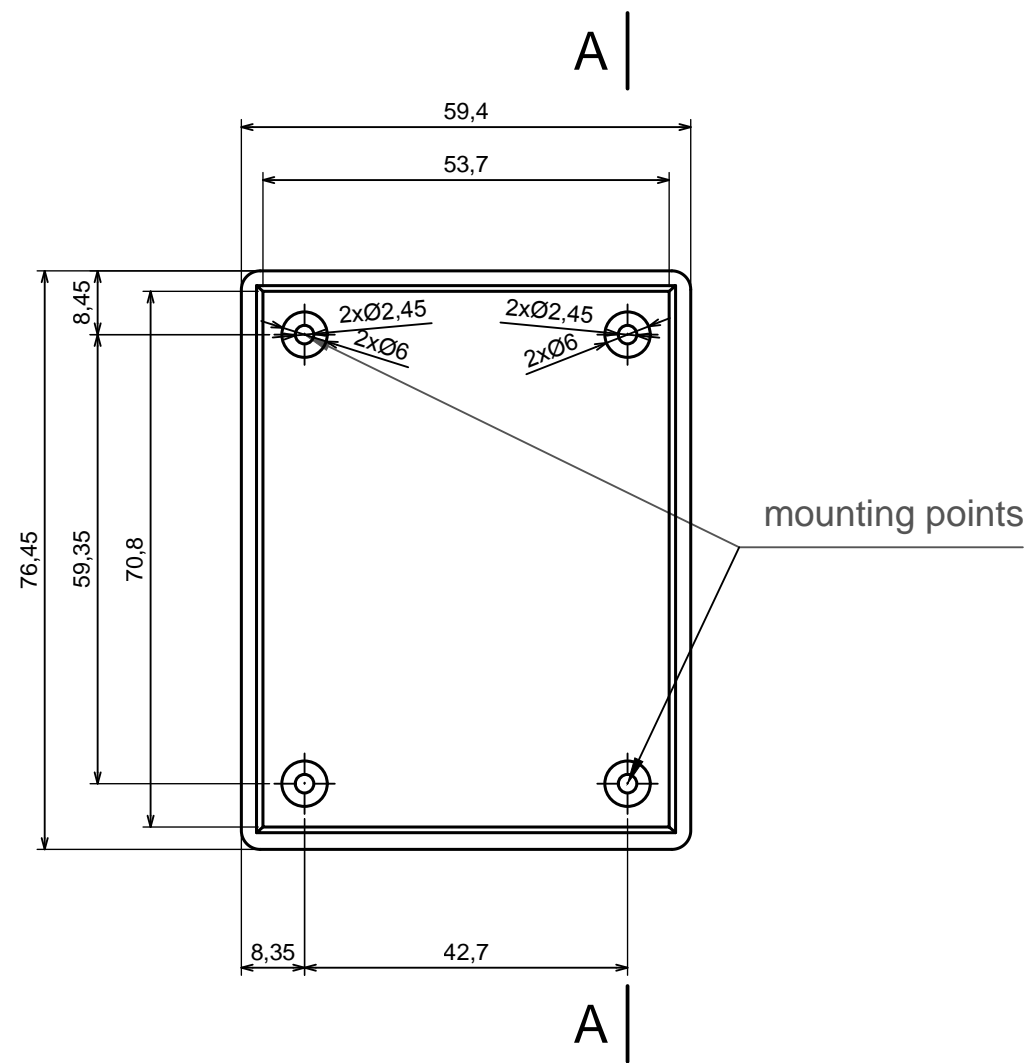

All rights reserved, Copyright Kradox 2016		
Product model	Enclosure Z71 - base	
Format: A3	Material: PS, ABS	
Scale 1:1	Tolerance: +/- 0.5	

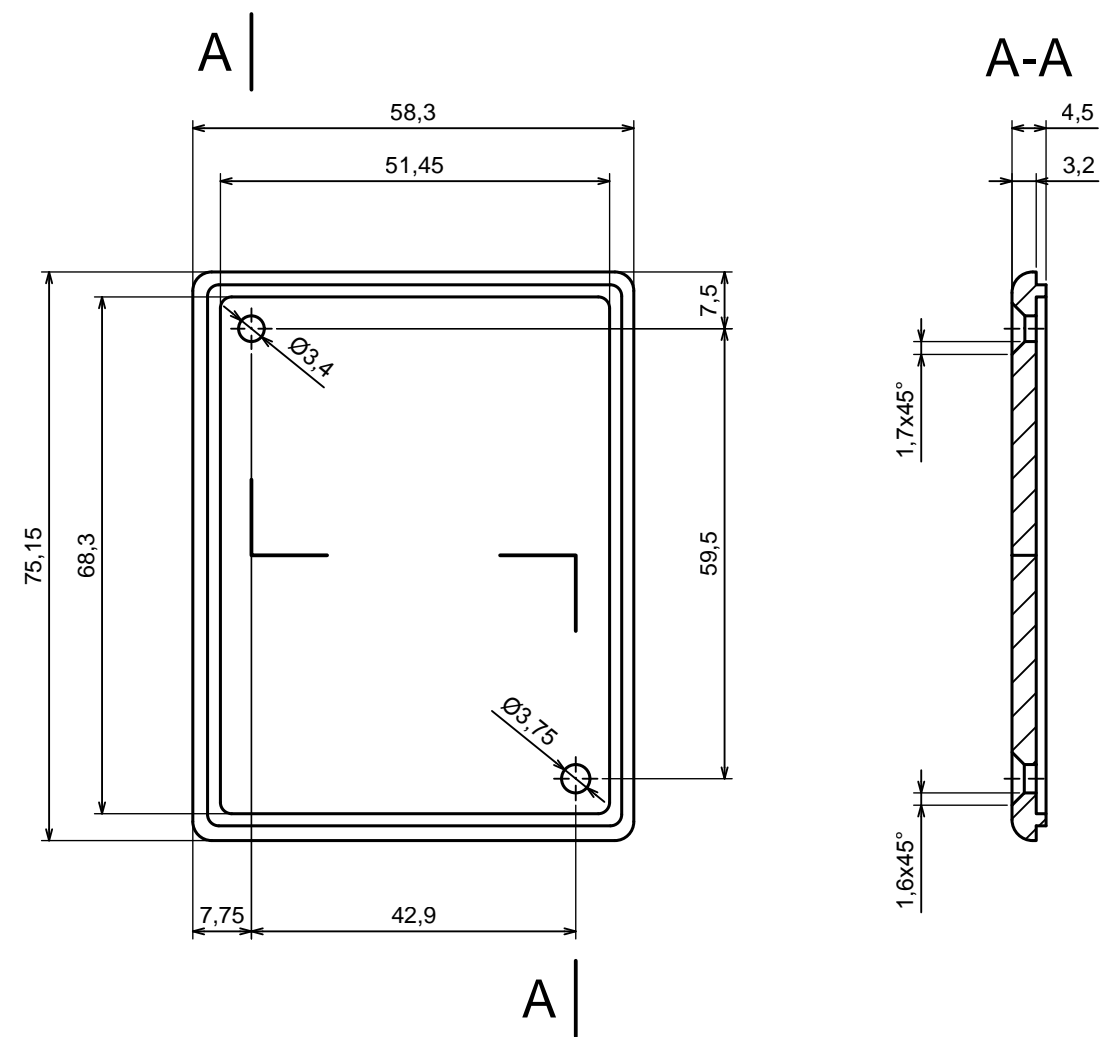

All rights reserved, Copyright Kradex 2016

Product model	Enclosure Z71 - cover	
Format: A3	Material: PS, ABS	
Scale 1:1	Tolerance: +/- 0.5	