

#8 SINGLE CONTACT Twinax Connectors

For weight/space saving MIL-STD-1553 Data Bussing Requirements, Pyle-National offers two (2) innovative Single Contact Connector designs. These designs utilize Qualified MIL-C-38999 Series III Shell Size 9 hardware and a wide variety of qualified and specialized #8 Twinax/Coax contacts.

Available in various shell styles, shell materials, and plating options (Classes F, W, K & S), each connector option incorporates unique design features.

SPECIFICATIONS (IN INCHES UNLESS OTHERWISE STATED)

Removable Contact Seal Boot Design

DESIGN FEATURES

- Insertable/removable #8 crimp twinax/coax contacts
- Sealing achieved by a removable contact/cable seal boot
- Plugs accept #8 socket twinax/coax contacts
- Receptacles accept #8 pin twinax/coax contacts
- Environmentally sealed
- Available with cable support
- Scoop-proof design
- Low profile design
- Contact grounded to shell

OPTIONAL CABLE SUPPORT TGW-R-5309-10 (Olive Drab Cadmium) TGF-R-5309-10 (Electroless Nickel)

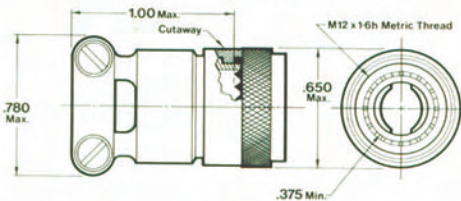

NON-DECOUPLING PLUG

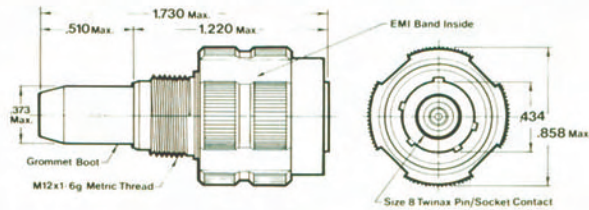

SQUARE FLANGE RECEPTACLE

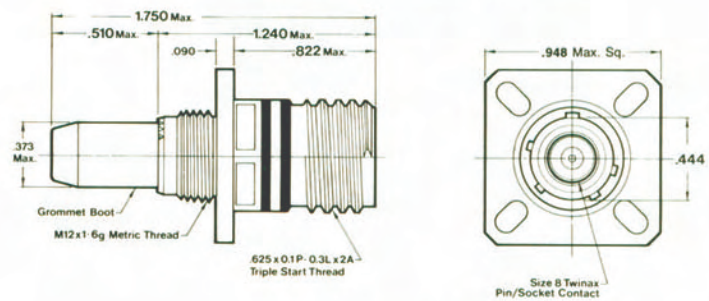

IN-LINE RECEPTACLE

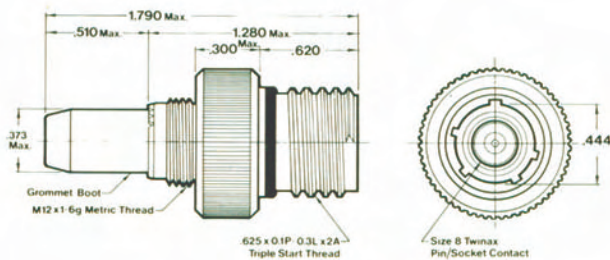

JAM-NUT RECEPTACLE

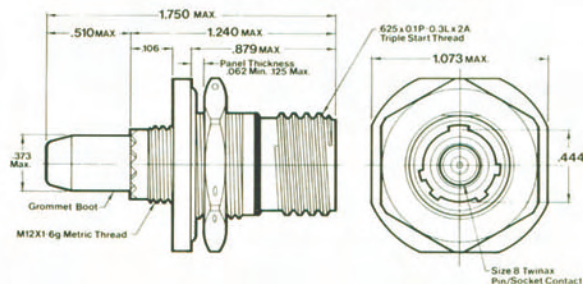

SPECIFICATIONS (IN INCHES UNLESS OTHERWISE STATED)

Fixed Integral Seal Design

DESIGN FEATURES

- Insertable/removable #8 crimp twinax/coax contacts
- Sealing achieved by a fixed integral contact/cable seal
- Plugs accept #8 socket twinax/coax contacts
- Receptacles accept #8 pin twinax/coax contacts
- Environmentally sealed
- Closed entry plug shell
- Scoop-proof design
- Contact grounded to shell

NON-DECOUPLING PLUG

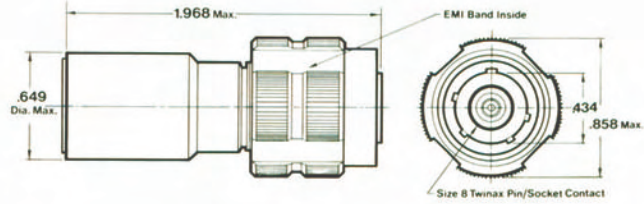

SQUARE FLANGE RECEPTACLE

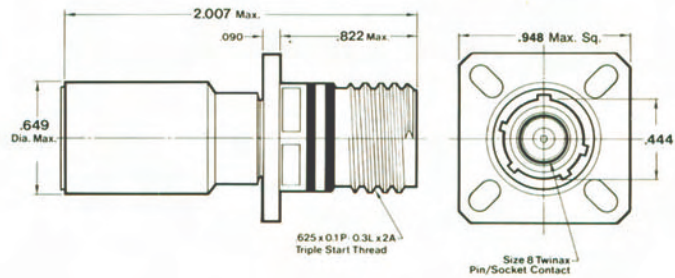

JAM-NUT RECEPTACLE

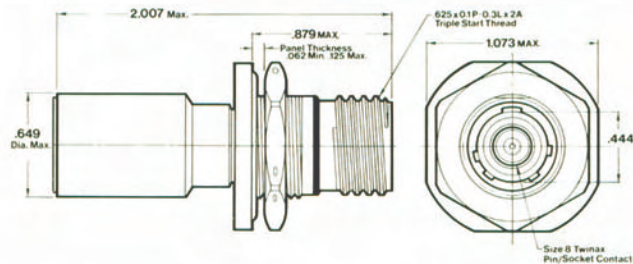

Note: Use contact removal tool part number TP-201391-8

PART NUMBER/ORDERING INFORMATION

#8 Single Contact Twinax Connectors

TG W - 12 B 09 -01 S N A

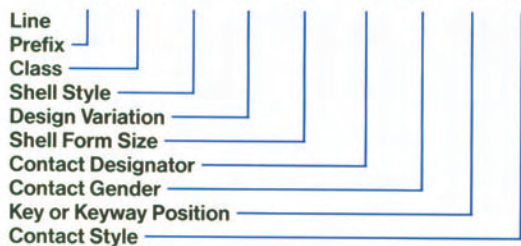

CLASS

- F Electroless Nickel Plated Aluminum
- W Corrosion Resistant Olive Drab Cadmium
- K Corrosion Resistant, Stainless Steel
- S Stainless Steel Electrodeposited Nickel Plated

SHELL STYLE

- 12 Plug
- 17 Receptacle
- 18 In-line Receptacle
- 19 Receptacle, Jam Nut Mount

DESIGN VARIATION

- A = Fixed integral seal adapter
- B = Removable grommet boot assembly

SHELL FORM SIZE

- 09 = Shell form size 9

CONTACT DESIGNATOR

- 01 = (1) #8 contact

CONTACT GENDER

- P = Pin (use with receptacle only)
- S = Socket (use with plug only)

KEY OR KEYWAY POSITION

- N = Normal
- A, B, C, D & E = Alternate

CONTACT STYLE

- (Omit for standard #8 twinax contact per MIL-C-39029/90 and /91)

- B = #8 twinax ("TB" style)*

- C = #8 coax contact*

- 105 designator for "without contacts"

*See Pyle Part numbers on Shielded Contacts table, page 9.

X-ON Electronics

Largest Supplier of Electrical and Electronic Components

Click to view similar products for [Circular MIL Spec Connector](#) category:

Click to view products by [Amphenol](#) manufacturer:

Other Similar products are found below :

[89075GULPR](#) [0025-262-542](#) [0025-264-3014](#) [58-570121-04S](#) [0134-213-1208](#) [0134-213-2209](#) [0025-258-000](#) [60-042022-07P](#) [60-042022-19P](#)
[60-042022-23P](#) [60-042217-10P](#) [0114-201-1278](#) [012-0467-000](#) [602GB06EG24-61SN](#) [0134-201-1207](#) [0134-213-1006](#) [6104-207-2302](#) [6104-](#)
[208-1902](#) [61-168211-04P](#) [61-168617-10P](#) [6131-202-19149P](#) [6131-204-21149P](#) [6131-208-13149P](#) [6131-209-17149P](#) [6131-210-11149P](#) [6131-](#)
[211-19149P](#) [6131-216-19149P](#) [6131-259-21149P](#) [6131-259-23149P](#) [6131-265-17149P](#) [6131-265-19149P](#) [CS3100A18-1P-472](#) [CS3100A-36-](#)
[77P](#) [CS3101A-16-55P](#) [CS3102A-10SL-55P](#) [CS3102A-14S-58P](#) [CS3102A-32-17P](#) [CS3102A32-25S](#) [CS3102C18-4P-472](#)
[CS3106A10SL3S004](#) [CS3106A-18-73S](#) [CS3108A-14S-52S](#) [CS3108A-28-51S](#) [6162-233-1277](#) [6162-324-1231](#) [M243082296Z](#)
[M2884010AC1S1](#) [CT0-24-10SC](#) [CT0M20-7PCAU](#) [M28840/17AC1G3](#)