

Performance and Material Specifications

MATERIALS AND FINISHES

	Material	Finish
Shell	Steel	Tin or yellow chromate over zinc or cadmium
Insulator	Thermoplastic-UL 94V-0	
Contacts	Pin: Brass Socket: Phosphor Bronze	Gold Over nickel

MECHANICAL FEATURES

Coupling — Friction and lock accessories
Polarization — Keystone-shaped shells

PERFORMANCE SPECIFICATIONS

Temperature Rating — -55°C to +105°C
Dielectric Withstanding Voltage — 1000 VAC sea level
Wire/Contact Size — #20 AWG
Current Rating — #20 contact 5 Amps

Dimensions/Part Numbers—Stamped Contacts

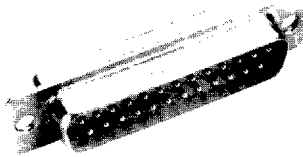

Number of Contacts (Shell Size)	Yellow Chromate Part Number	Tin Part Number
9(E)	DE9P	DE9PK87
	DE9S	DE9SA197
15(A)	DA15P	DA15PK87
	DA15S	DA15SA197
25(B)	DB25P	DB25PK87
	DB25S	DB25SA197
37(C)	DC37P	DC37PK87
	DC37S	DC37SA197
50(D)	DD50P	DD50PK87
	DD50S	DD50SA197

Dimensions/Part Numbers – Machined Contacts (Non-Removable)

With .120" Through-Mounting Holes

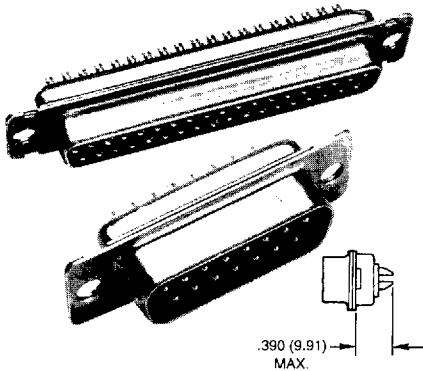

Layout	Tin/ Gold Over Nickel	Yellow Chromate/ Gold Over Nickel	Tin/ 30µ in. Gold
DE-9S	DEM9SA197	DEM9S	DEM9SK126
DE-9P	DEM9PK87	DEM9P	DEM9PK127
DA-15S	DAM15SA197	DAM15S	DAM15SK126
DA-15P	DAM15PK87	DAM15P	DAM15PK127
DB-25S	DBM25SA197	DBM25S	DBM25SK126
DB-25P	DBM25PK87	DBM25P	DBM25PK127
DC-37S	DCM37SA197	DCM37S	DCM37SK126
DC-37P	DCM37PK87	DCM37P	DCM37PK127
DD-50S	DDM50SA197	DDM50S	DDM50SK126
DD-50P	DDM50PK87	DDM50P	DDM50PK127

Mounting Options Available:

- 4-40 Clinch Nut – Add "E" to Part Number After "M".
- Float Mount – Add "Y" to Part Number After "M".

(Can be used in front or rear panel mount applications)

Example: DBME25SA197 DEMY9PK87

Performance Specifications – Page 2
Standard Shell Dimensions – Page 73
Mounting Method Detail – Page 6

Highlighted part numbers indicate standard product; usually available with shorter lead times.

Mounting Option Dimensions – Solder Cup Connectors

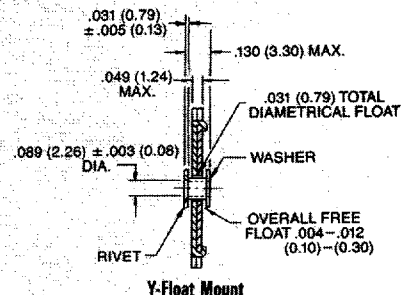
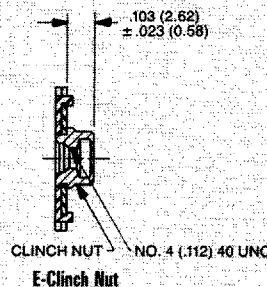
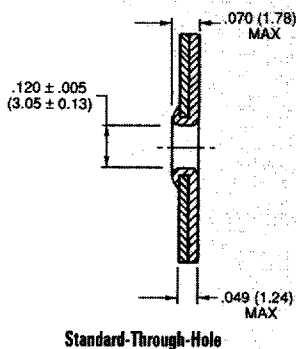

It is recommended that only one assembly, either pin or socket, be float mounted.

Panel Cutouts

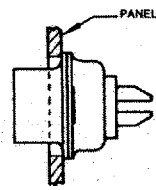

Rear mounting of standard shell

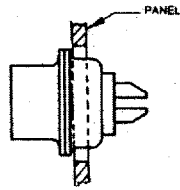

Front mounting of standard shell

Standard Cutout

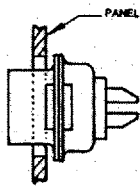
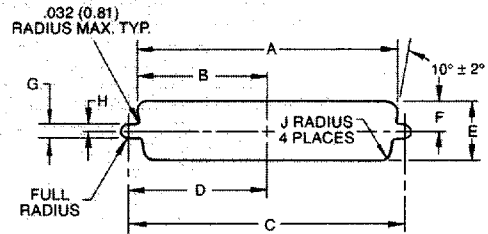

Rear mounting of float mount shell (Y-code)

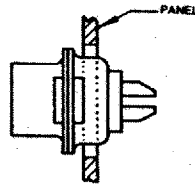

Front mounting of reverse float mount shell (Y-code)

Optional Cutout (For Rear Mounting)

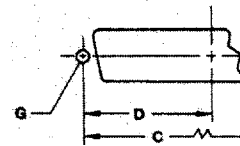

Connector Size	Mounting Method	A ±.005 (0.13)	B ±.005 (0.13)	C ±.005 (0.13)	D ±.005 (0.13)	E ±.005 (0.13)	F ±.005 (0.13)	G ±.002 (0.05)	H ±.002 (0.05)	J ±.002 (0.05)
A Standard	Front Mounting	1.202 (30.53)	.601 (15.26)	1.312 (33.32)	.656 (16.66)	.513 (13.03)	.257 (6.52)	.120 (3.04)	.060 (1.52)	.083 (2.10)
	Rear Mounting	1.134 (28.80)	.567 (14.40)	1.312 (33.32)	.656 (16.66)	.449 (11.40)	.225 (5.71)	.120 (3.04)	.060 (1.52)	.132 (3.35)
A Float	Front Mounting	1.234 (31.34)	.617 (15.67)	1.312 (33.32)	.656 (16.66)	.545 (13.84)	.273 (6.93)	.088 (2.23)	.044 (1.11)	.083 (2.10)
	Rear Mounting	1.166 (29.61)	.583 (14.80)	1.312 (33.32)	.656 (16.66)	.481 (12.21)	.241 (6.12)	.088 (2.23)	.044 (1.11)	.132 (3.35)
B Standard	Front Mounting	1.743 (44.27)	.872 (22.14)	1.852 (47.04)	.926 (23.52)	.513 (13.03)	.257 (6.52)	.120 (3.04)	.060 (1.52)	.083 (2.10)
	Rear Mounting	1.674 (42.51)	.837 (21.25)	1.852 (47.04)	.926 (23.52)	.449 (11.40)	.225 (5.71)	.120 (3.04)	.060 (1.52)	.132 (3.35)
B Float	Front Mounting	1.775 (45.08)	.888 (22.55)	1.852 (47.04)	.926 (23.52)	.545 (13.84)	.273 (6.93)	.088 (2.23)	.044 (1.11)	.083 (2.10)
	Rear Mounting	1.706 (43.33)	.853 (21.66)	1.852 (47.04)	.926 (23.52)	.481 (12.21)	.241 (6.12)	.088 (2.23)	.044 (1.11)	.132 (3.35)
C Standard	Front Mounting	2.391 (60.73)	1.196 (30.37)	2.500 (63.50)	1.250 (31.75)	.513 (13.03)	.257 (6.52)	.120 (3.04)	.060 (1.52)	.083 (2.10)
	Rear Mounting	2.326 (59.08)	1.163 (29.54)	2.500 (63.50)	1.250 (31.75)	.449 (11.40)	.225 (5.71)	.120 (3.04)	.060 (1.52)	.132 (3.35)
C Float	Front Mounting	2.423 (61.54)	1.212 (30.78)	2.500 (63.50)	1.250 (31.75)	.545 (13.84)	.273 (6.93)	.088 (2.23)	.044 (1.11)	.083 (2.10)
	Rear Mounting	2.354 (59.79)	1.177 (29.89)	2.500 (63.50)	1.250 (31.75)	.481 (12.21)	.241 (6.12)	.088 (2.23)	.044 (1.11)	.132 (3.35)
D Standard	Front Mounting	2.297 (58.34)	1.149 (29.18)	2.406 (61.11)	1.203 (30.55)	.623 (15.82)	.312 (7.92)	.120 (3.04)	.060 (1.52)	.083 (2.10)
	Rear Mounting	2.218 (56.33)	1.109 (28.16)	2.406 (61.11)	1.203 (30.55)	.555 (14.09)	.278 (7.06)	.120 (3.04)	.060 (1.52)	.132 (3.35)
D Float	Front Mounting	2.329 (59.15)	1.165 (29.59)	2.406 (61.11)	1.203 (30.55)	.655 (16.63)	.328 (8.33)	.088 (2.23)	.044 (1.11)	.083 (2.10)
	Rear Mounting	2.250 (57.15)	1.125 (28.57)	2.406 (61.11)	1.203 (30.55)	.587 (14.90)	.294 (7.46)	.088 (2.23)	.044 (1.11)	.132 (3.35)
E Standard	Front Mounting	.874 (22.19)	.437 (11.09)	.984 (24.99)	.492 (12.49)	.513 (13.03)	.257 (6.52)	.120 (3.04)	.060 (1.52)	.083 (2.10)
	Rear Mounting	.806 (20.47)	.403 (10.23)	.984 (24.99)	.492 (12.49)	.449 (11.40)	.225 (5.71)	.120 (3.04)	.060 (1.52)	.132 (3.35)
E Float	Front Mounting	.906 (23.01)	.453 (11.50)	.984 (24.99)	.492 (12.49)	.545 (13.84)	.273 (6.93)	.088 (2.23)	.044 (1.11)	.083 (2.10)
	Rear Mounting	.838 (21.28)	.419 (10.64)	.984 (24.99)	.492 (12.49)	.481 (12.21)	.241 (6.12)	.088 (2.23)	.044 (1.11)	.132 (3.35)

Contact Arrangements – Standard

Face View Pin Insert

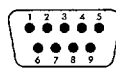

E
9
#20

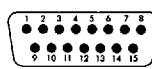

A
15
#20

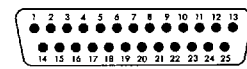

B
25
#20

Shell Size
Contact Arrangement
Contact Size

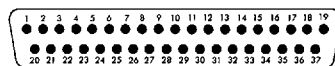

C
37
#20

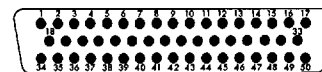

D
50
#20

Shell Size
Contact Arrangement
Contact Size

Contact Arrangements – High Density

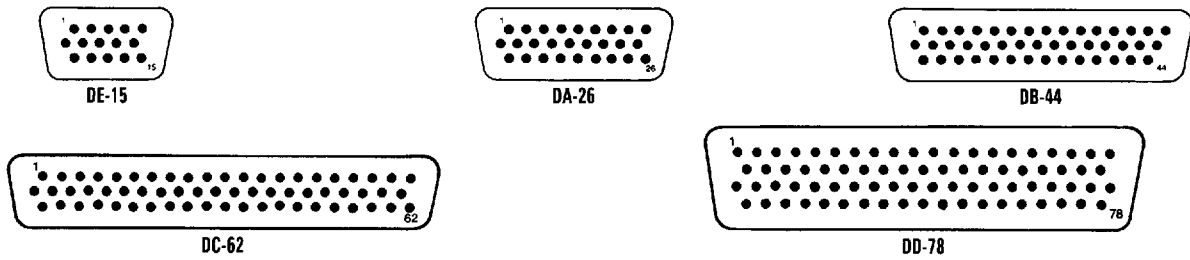

Panel Mounting

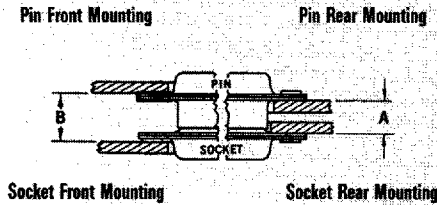

Figure 1A

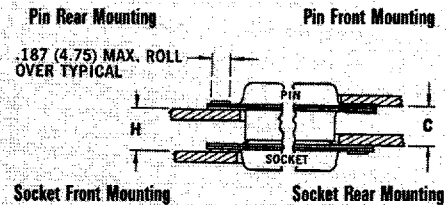

Figure 1B

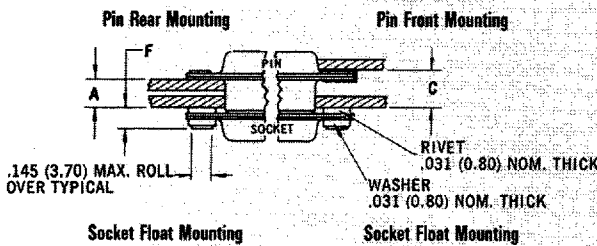

Figure 2

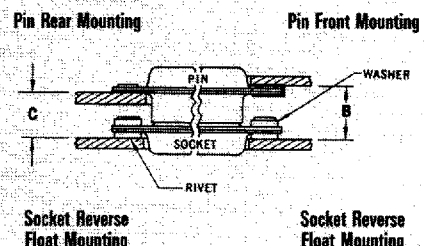

Figure 3

Fig. No.	Combination of Mated Connectors		A +.030 (+0.76) -.000 (-0)	B +.030 (+0.76) -.000 (-0)	C +.030 (+0.76) -.000 (-0)	F ±.010 (±0.25)	H +.030 (+0.76) -.000 (-0)	
	Size	Pin (See Note Below)						Socket
1	A, E	Standard	Standard	.250 (6.35)	.340 (8.63)	.295 (7.49)	-	.295 (7.49)
1	B, C, D	Standard	Standard	.238 (6.04)	.343 (8.71)	.298 (7.56)	-	.283 (7.18)
2	A, E	Standard	Float Mount	.218 (5.53)	-	.263 (6.68)	.120 (3.04)	-
2	B, C, D	Standard	Float Mount	.206 (5.23)	-	.266 (6.75)	.120 (3.04)	-
2	A, E	Float Mount	Standard	.218 (5.53)	-	.263 (6.68)	.120 (3.04)	-
2	B, C, D	Float Mount	Standard	.206 (5.23)	-	.251 (6.37)	.130 (3.30)	-
3	A, E	Standard	Rev. Float Mount	-	.358 (9.09)	.313 (7.95)	.120 (3.04)	-
3	B, C, D	Standard	Rev. Float Mount	-	.361 (9.16)	.301 (7.64)	.120 (3.04)	-
3	A, E	Rev. Float Mount	Standard	-	.358 (9.09)	.313 (7.95)	.120 (3.04)	-
3	B, C, D	Rev. Float Mount	Standard	-	.355 (9.01)	.310 (7.87)	.130 (3.30)	-

NOTES:

1. A, B, C and H are dimensions between panels and represent the recommended limit to be used in the design of the connector mounting method.
2. It is recommended that only one assembly, either pin or socket, be float mounted.
3. Standard pin assemblies contained .015 (0.38) thick front shells on E and A sizes; .024 (0.61) thick front shells on B, C, and D sizes.
4. Standard connectors accommodate a #4 screw. Float mount connectors accommodate a #2 screw.

Standard D Shell Dimensions

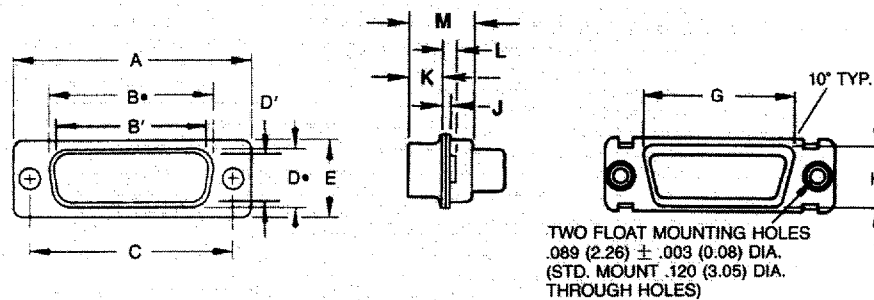

Shell Size	A ±.015 (0.38)	B [•] ±.010 (0.25)	B' [•] ±.010 (0.25)	C ±.008 (0.2)	D [•] ±.010 (0.25)	D' [•] ±.010 (0.25)	E ±.016 (0.4)	G Max.	H Max.	J ±.010 (0.25)	K ±.010 (0.25)	L Max.	M Max.
DE-9P	1.213 (30.81)	—	.667 (16.94)	.984 (24.99)	—	.329 (8.36)	.494 (12.55)	.765 (19.41)	.430 (10.92)	.032 (0.81)	.236 (5.99)	.075 (1.90)	.438 (11.12)
DE-9S	1.213 (30.81)	.642 (16.31)	—	.984 (24.99)	.310 (7.87)	—	.494 (12.55)	.765 (19.41)	.430 (10.92)	.032 (0.81)	.242 (6.15)	.075 (1.90)	.438 (11.12)
DA-15P	1.539 (39.14)	—	.995 (25.27)	1.311 (33.32)	—	.329 (8.36)	.494 (12.55)	1.088 (27.64)	.430 (10.92)	.032 (0.81)	.236 (5.99)	.075 (1.90)	.438 (11.12)
DA-15S	1.539 (39.14)	.970 (24.64)	—	1.311 (33.32)	.310 (7.87)	—	.494 (12.55)	1.088 (27.64)	.430 (10.92)	.032 (0.81)	.242 (6.15)	.075 (1.90)	.438 (11.12)
DB-25P	2.087 (53.03)	—	1.535 (38.99)	1.850 (47.04)	—	.329 (8.36)	.494 (12.55)	1.630 (41.40)	.430 (10.92)	.036 (0.91)	.232 (5.99)	.075 (1.90)	.438 (11.12)
DB-25S	2.087 (53.03)	1.510 (38.35)	—	1.850 (47.04)	.310 (7.87)	—	.494 (12.55)	1.630 (41.40)	.430 (10.92)	.032 (0.81)	.242 (6.15)	.075 (1.90)	.438 (11.12)
DC-37P	2.728 (69.31)	—	2.183 (55.45)	2.500 (63.50)	—	.329 (8.36)	.494 (12.55)	2.278 (57.86)	.430 (10.92)	.036 (0.91)	.232 (5.99)	.075 (1.90)	.438 (11.12)
DC-37S	2.728 (69.31)	2.158 (54.81)	—	2.500 (63.50)	.310 (7.87)	—	.494 (12.55)	2.278 (57.86)	.430 (10.92)	.032 (0.81)	.242 (6.15)	.075 (1.90)	.438 (11.12)
DD-50P	2.634 (66.92)	—	2.080 (52.83)	2.406 (61.11)	—	.436 (11.07)	.605 (15.37)	2.183 (55.45)	.542 (13.77)	.036 (0.91)	.232 (5.99)	.075 (1.90)	.438 (11.12)
DD-50S	2.634 (66.92)	2.063 (52.40)	—	2.406 (61.11)	.422 (10.72)	—	.605 (15.37)	2.183 (55.45)	.542 (13.77)	.032 (0.81)	.242 (6.15)	.075 (1.90)	.438 (11.12)

NOTE: Dimensions B[•], D[•], G and H are measured as outside dimensions at the bottom of the draw. B[•] and D[•] are the O.D. dims. for socket side; B'[•] and D'[•] are the inside dims. for pin side.

X-ON Electronics

Largest Supplier of Electrical and Electronic Components

Click to view similar products for [D-Sub Standard Connectors](#) category:

Click to view products by [ITT](#) manufacturer:

Other Similar products are found below :

[DCM37S732N](#) [DAM15P500](#) [DEV09S364GTLF](#) [DEM09P032N](#) [DDM50P732N](#) [DAM15S332N](#) [173109-2218](#) [173109-2466](#) [173109-2436](#)
[173109-2435](#) [56F706-005-LI](#) [56F711-015](#) [015-0341-000](#) [015-0372-008](#) [015-8544-011](#) [017041-0005](#) [020419-0104](#) [012-0515-000](#) [012-9507-](#)
[034](#) [012-9507-114](#) [012-9534-001](#) [020745-0008](#) [609-25P](#) [M24308/2-23Z](#) [M243082310F](#) [M243082410F](#) [M243082411F](#) [M24308/4-21](#)
[CT1A18-11PSA206](#) [CT1N36-5SC](#) [CT2-16S-17PS](#) [CT2-20-15PCAU](#) [CT2-24-12PS](#) [CT2-24-28PSF127A206](#) [CT2-32-9PC](#) [CT6F9767-14-4-](#)
[14S-5PC](#) [CT6FA10SL-4PS](#) [CT7-18-10SC](#) [CT7-18-10SCAU](#) [CT7-18-12SCAU](#) [CT7-18-1PC](#) [CT7-18-1PCAU](#) [CT7-18-21SCAU](#) [M83513/01-](#)
[FC](#) [M83723/76W24619 L/C](#) [M85049/48-3-2F](#) [69001-865](#) [6STD09PCM99B70X](#) [6STD09SCM99B30X](#) [6STD09SCT99S40X](#)