

# Key-type Selector Switches

## A22NK

### Keyed 22-mm Selector Switches

#### Universal Design.

#### Emphasis on Color Coding, Workability, and Safety.

#### Easy to Use

- You can connect up to three Contact Blocks in one stage for multistage expansion.
- The terminals can be retightened when Contact Blocks are stacked.
- Contact Blocks can be attached in any direction for easy assembly.
- Screw terminal structure is compatible with round crimp terminals.

#### Safety

- Easy-to-operate lock lever for secure locking.
- Easy-mounting Contact Blocks provide finger protection.
- Different colors of Contact Blocks (NO: blue, NC: orange) help prevent wiring errors.

#### Product Lineup

- Meet global safety standards.
- Available with metal or plastic bezels.
- All models are keyed alike.
- Standard-feature degree of protection: IP66 and NEMA 13.

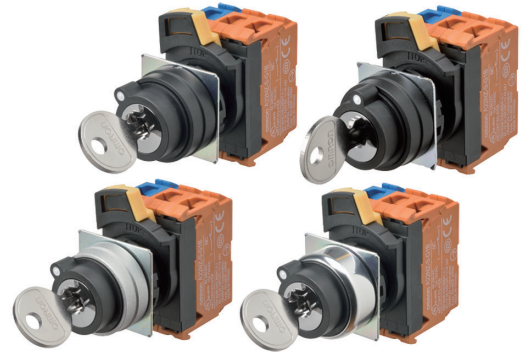

Refer to *Safety Precautions for All Pushbutton Switches/Indicators* and *Safety Precautions in the A22NN/A22NL datasheet*

# A22NK

## Model Number Structure

### Model Number Legend

----- Shipped as a set that includes the Operation Unit, Mounting Collar, and Contact Block.  
For information on combinations, refer to *Ordering Information* on pages 5 to 6.

### Model Numbers for Sets

A 2 2 N <sup>(1)</sup> **K** - <sup>(2)</sup> **2B** <sup>(3)</sup> **M** - <sup>(4)</sup> **01** <sup>(5)</sup> **A** <sup>(6)</sup> **A** - <sup>(7)</sup> **G** <sup>(8)</sup> **100**

#### (1) Type

Code	Type
K	Key-type Selector Switch

#### (4) Key Number

Code	No.
01	No.1

#### (7) Contact Specification

Code	Description
G	General purpose

#### (2) Number of Positions and Bezel Material

Code	No. of positions	Bezel material
2B	2	Plastic
2M	2	Brushed metal
2R	2	Metal
3B	3	Plastic
3M	3	Brushed metal
3R	3	Metal

#### (5) Key Release Position

Code	Release position	Two positions	Three positions
A	All positions		
B	Left		
C	Right		
D	Center	---	
G	Left and right	---	

○: Release position  
●: Locked position

#### (8) Contact Configuration

Code	Contact Blocks		Unit position			Two positions	Three positions
	NO	NC	1	2	3		
100	1	0	NO	---	---	Yes	---
002	0	1	---	---	NC	Yes	---
101	2	0	NO	---	NO	Yes	Yes
102	1	1	NO	---	NC	Yes	Yes
201	1	1	NC	---	NO	---	Yes
202	0	2	NC	---	NC	Yes	Yes
110	2	0	NO	NO	---	---	Yes
111	3	0	NO	NO	NO	Yes	Yes
112	2	1	NO	NO	NC	Yes	Yes
210	1	1	NC	NO	---	---	Yes
211	2	1	NC	NO	NO	---	Yes
212	1	2	NC	NO	NC	---	Yes
011	2	0	---	NO	NO	---	Yes
012	1	1	---	NO	NC	---	Yes
120	1	1	NO	NC	---	---	Yes
121	2	1	NO	NC	NO	---	Yes
122	1	2	NO	NC	NC	Yes	Yes
220	0	2	NC	NC	---	---	Yes
221	1	2	NC	NC	NO	---	Yes
222	0	3	NC	NC	NC	Yes	Yes
021	1	1	---	NC	NO	---	Yes
022	0	2	---	NC	NC	---	Yes

**Note:** 1. NO (blue): Normally open, NC (orange): Normally closed.

2. Refer to the following figure for Unit positions.

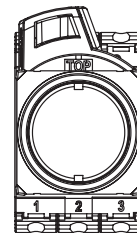

#### (3) Reset Method

Code	Reset method		
M	Manual	Two-positions manual	
		Three-positions manual	
L	Automatic reset on left	Two-positions automatic	
		Three-positions left automatic	
R	Automatic reset on right	Three-positions right automatic	
B	Automatic reset on left and right	Three-positions left or right automatic	

#### (6) Degree of Protection

Code	Protection
A	IP66, NEMA13

### Operation Angle

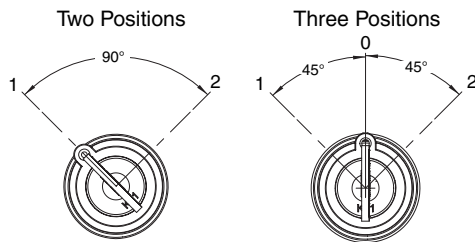

■ Specifications: Refer to page 10 and refer to the A22NN/A22NL. ■ Precautions for correct use: Refer to the A22NN/A22NL.  
■ Dimensions: Refer to page 11.

## Structure

### Contact Configuration Table

#### Two Positions

No. of outputs	Code	Contact configuration	Unit position	Contacts	Position	
					1	2
1	100	SPST-NO	(1)	NO		ON
			(2)	---	---	---
			(3)	---	---	---
1	002	SPST-NC	(1)	---	---	---
			(2)	---	---	---
			(3)	NC	ON	
2	102	SPST-NO/ SPST-NC	(1)	NO		ON
			(2)	---	---	---
			(3)	NC	ON	
2	101	DPST-NO	(1)	NO		ON
			(2)	---	---	---
			(3)	NO		ON
2	202	DPST-NC	(1)	NC	ON	
			(2)	---	---	---
			(3)	NC	ON	
3	111	3PST-NO	(1)	NO		ON
			(2)	NO		ON
			(3)	NO		ON
3	222	3PST-NC	(1)	NC	ON	
			(2)	NC	ON	
			(3)	NC	ON	
3	122	SPST-NO/ DPST-NC	(1)	NO		ON
			(2)	NC	ON	
			(3)	NC	ON	
3	112	DPST-NO/ SPST-NC	(1)	NO		ON
			(2)	NO		ON
			(3)	NC	ON	

### Operation Angle

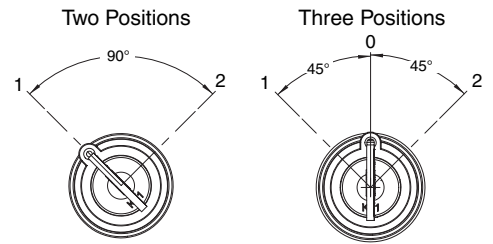

#### Three Positions

No. of outputs	Code	Contact configuration	Unit position	Contacts	Position		
					1	0	2
2	110	DPST-NO	(1)	NO	ON		
			(2)	NO	ON		ON
			(3)	---	---	---	---
2	011	DPST-NO	(1)	---	---	---	---
			(2)	NO	ON		ON
			(3)	NO			ON
2	101	DPST-NO	(1)	NO	ON		
			(2)	---	---	---	---
			(3)	NO			ON
2	220	DPST-NC	(1)	NC		ON	ON
			(2)	NC		ON	
			(3)	---	---	---	---
2	022	DPST-NC	(1)	---	---	---	---
			(2)	NC		ON	
			(3)	NC	ON	ON	
2	202	DPST-NC	(1)	NC		ON	ON
			(2)	---	---	---	---
			(3)	NC	ON	ON	
2	120	SPST-NO/ SPST-NC	(1)	NO	ON		
			(2)	NC		ON	
			(3)	---	---	---	---

No. of outputs	Code	Contact configuration	Unit position	Contacts	Position		
					1	0	2
2	102	SPST-NO/ SPST-NC	(1)	NO	ON		
			(2)	---	---	---	---
			(3)	NC	ON	ON	
2	210	SPST-NO/ SPST-NC	(1)	NC		ON	ON
			(2)	NO	ON		ON
			(3)	---	---	---	---
2	201	SPST-NO/ SPST-NC	(1)	NC		ON	ON
			(2)	---	---	---	---
			(3)	NO			ON
2	012	SPST-NO/ SPST-NC	(1)	---	---	---	---
			(2)	NO	ON		ON
			(3)	NC	ON	ON	
2	021	SPST-NO/ SPST-NC	(1)	---	---	---	---
			(2)	NC		ON	
			(3)	NO			ON
3	111	3PST-NO	(1)	NO	ON		
			(2)	NO	ON		ON
			(3)	NO			ON
3	222	3PST-NC	(1)	NC		ON	ON
			(2)	NC		ON	
			(3)	NC	ON	ON	
3	122	SPST-NO/ DPST-NC	(1)	NO	ON		
			(2)	NC		ON	
			(3)	NC	ON	ON	
3	212	SPST-NO/ DPST-NC	(1)	NC		ON	ON
			(2)	NO	ON		ON
			(3)	NC	ON	ON	
3	221	SPST-NO/ DPST-NC	(1)	NC		ON	ON
			(2)	NC		ON	
			(3)	NO	ON		ON
3	211	DPST-NO/ SPST-NC	(1)	NC		ON	ON
			(2)	NO	ON		ON
			(3)	NO			ON
3	121	DPST-NO/ SPST-NC	(1)	NO	ON		
			(2)	NC		ON	
			(3)	NO			ON
3	112	DPST-NO/ SPST-NC	(1)	NO	ON		
			(2)	NO	ON		ON
			(3)	NC	ON	ON	

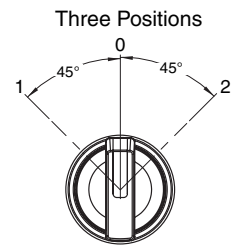

Operation Angle





## Ordering Information

**Model Numbers for Sets** - - - Shipped as a set that includes the Operation Unit, Mounting Collar, and Contact Block.

### Two-position, Key-type Selector Switches

Appearance	Bezel material	No. of outputs	Model	(3) Reset method	(5) Key release positions	(8)(8)(8) Contact configuration				
Plastic bezels 	2B	1	A22NK-2B(3)-01(5)A-G(8)(8)(8)	M: Manual L: Automatic reset on left	A: All positions B: Left C: Right	100 002				
		2				102 101 202				
		3				111 222 122 112				
Brushed metal bezels 	2M	1	A22NK-2M(3)-01(5)A-G(8)(8)(8)			M: Manual L: Automatic reset on left	A: All positions B: Left C: Right	100 002		
		2						102 101 202		
		3						111 222 122 112		
Metal bezels 	2R	1	A22NK-2R(3)-01(5)A-G(8)(8)(8)					M: Manual L: Automatic reset on left	A: All positions B: Left C: Right	100 002
		2								102 101 202
		3								111 222 122 112

## Three-position, Key-type Selector Switches

Appearance	Bezel material	No. of outputs	Model	(3) Reset method	(5) Key release positions	(8)(8)(8) Contact configuration				
Plastic bezels  	3B	2	A22NK-3B(3)-01(5)A-G(8)(8)(8)	M: Manual L: Automatic reset on left R: Automatic reset on right B: Automatic reset on left and right	A: All positions B: Left C: Right D: Center G: Left and right	110 011 101 220 022 202 120 102 210 201 012 021				
		3				111 222 122 212 221 211 121 112				
Brushed metal bezels  	3M	2	A22NK-3M(3)-01(5)A-G(8)(8)(8)			M: Manual L: Automatic reset on left R: Automatic reset on right B: Automatic reset on left and right	A: All positions B: Left C: Right D: Center G: Left and right	110 011 101 220 022 202 120 102 210 201 012 021		
		3						111 222 122 212 221 211 121 112		
Metal bezels  	3R	2	A22NK-3R(3)-01(5)A-G(8)(8)(8)					M: Manual L: Automatic reset on left R: Automatic reset on right B: Automatic reset on left and right	A: All positions B: Left C: Right D: Center G: Left and right	110 011 101 220 022 202 120 102 210 201 012 021
		3								111 222 122 212 221 211 121 112

■ Subassemblies: Refer to pages 7 to 9.  
 (You can order Operation Units, Mounting Collars, and Contact Blocks individually.)

■ Specifications: Refer to page 10 and refer to the A22NN/A22NL.  
 ■ Dimensions: Refer to page 11.  
 ■ Accessories and tools: Refer to the A22NN/A22NL.

## Ordering Information

**Subassemblies** - - - - You can order Operation Units, Mounting Collars, and Contact Blocks individually. Use them in combination for models that are not available as assembled Switches. They can also be used as inventory for maintenance parts.

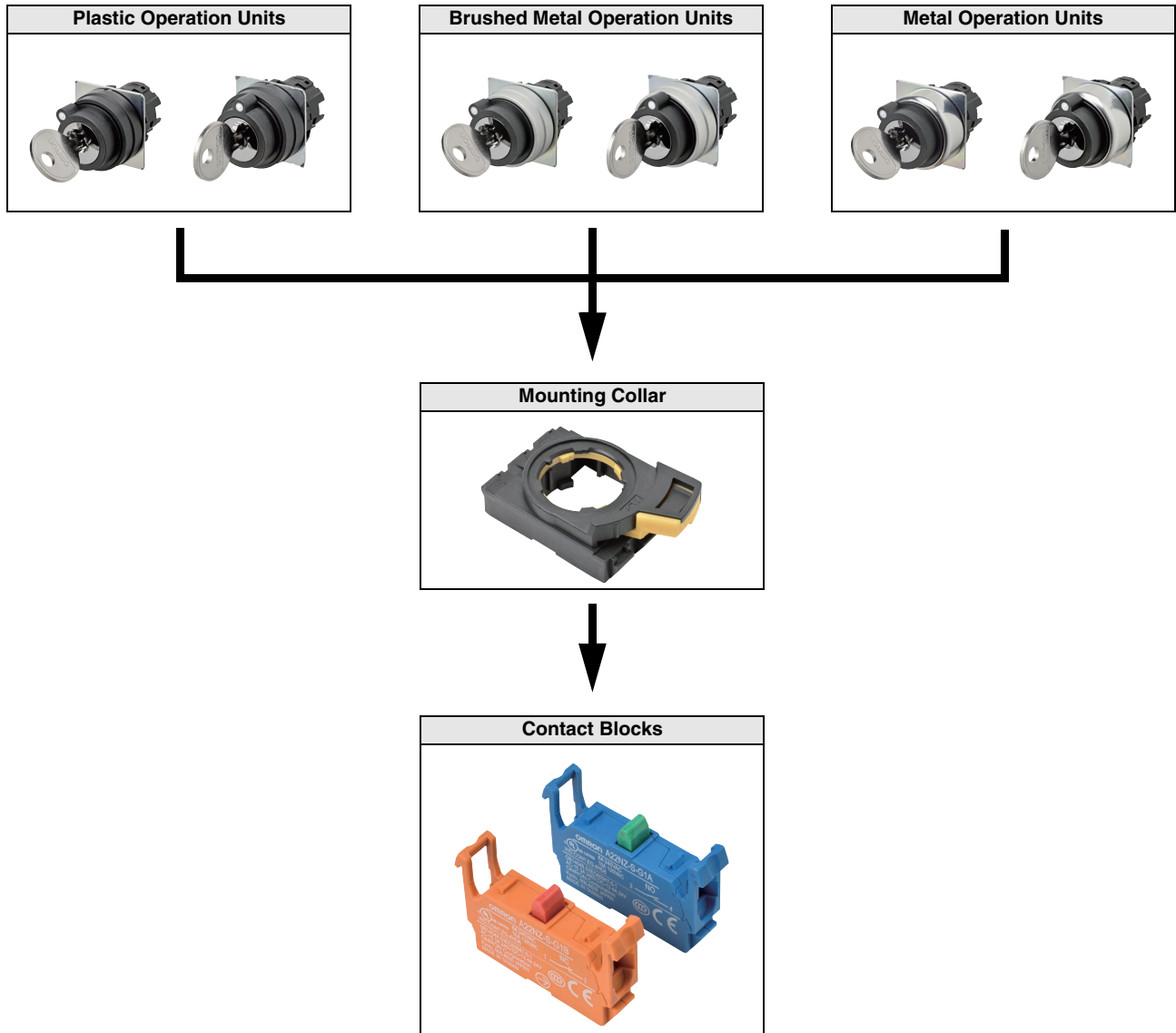

**Note:** Use a Reinforcement Plate for greater strength.

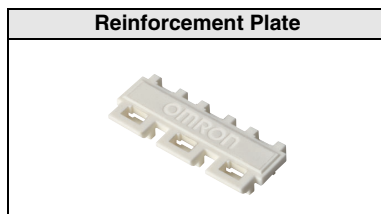

■ Model numbers of sets: Refer to page 5.







■ Specifications: Refer to page 10 and refer to the A22NN/A22NL.  
 ■ Dimensions: Refer to page 11.  
 ■ Accessories and tools: Refer to the A22NN/A22NL.

# A22NK

## Ordering Information

**Subassemblies** - - - - You can order Operation Units, Mounting Collars, and Contact Blocks individually. Use them in combination for models that are not available as assembled Switches. They can also be used as inventory for maintenance parts.

### Operation Units

Bezel material and shape		Plastic		Brushed metal		Metal		(1) Key release positions
								
No. of positions	Reset method	Model		Model		Model		
2	Manual	A22NZ-2BM-01(1)A		A22NZ-2MM-01(1)A		A22NZ-2RM-01(1)A		A: All positions B: Left C: Right
	Automatic reset on left	A22NZ-2BL-01(1)A		A22NZ-2ML-01(1)A		A22NZ-2RL-01(1)A		
3	Manual	A22NZ-3BM-01(1)A		A22NZ-3MM-01(1)A		A22NZ-3RM-01(1)A		A: All positions B: Left C: Right D: Center G: Left and right
	Automatic reset on left	A22NZ-3BL-01(1)A		A22NZ-3ML-01(1)A		A22NZ-3RL-01(1)A		
	Automatic reset on right	A22NZ-3BR-01(1)A		A22NZ-3MR-01(1)A		A22NZ-3RR-01(1)A		
	Automatic reset on left and right	A22NZ-3BB-01(1)A		A22NZ-3MB-01(1)A		A22NZ-3RB-01(1)A		

■ Model numbers of sets: Refer to page 5.

■ Specifications: Refer to page 10 and refer to the A22NN/A22NL.  
 ■ Dimensions: Refer to page 11.  
 ■ Accessories and tools: Refer to the A22NN/A22NL.



## Ordering Information

**Subassemblies** -- You can order Operation Units, Mounting Collars, and Contact Blocks individually. Use them in combination for models that are not available as assembled Switches. They can also be used as inventory for maintenance parts.

### Mounting Collar

Appearance	Model
	A22NZ-H-01

### Contact Blocks

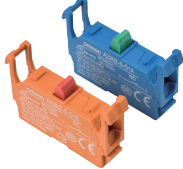
Appearance	Contact Specification	Model
	SPST-NO (blue)	A22NZ-S-G1A
	SPST-NC (orange)	A22NZ-S-G1B

### Reinforcement Plate

Appearance	Model
	A22NZ-A-C01

### Accessories

Appearance	Model
Key 	A22NZ-K-01

# A22NK

## Specifications

### Characteristics

Item	Type	Key-type Selector Switches
	Allowable operating frequency	Mechanical
Electrical		30 operations/minute max.
Insulation resistance		100 MΩ min. (at 500 VDC)
Contact resistance		100 mΩ max. (initial value)
Dielectric strength	Between terminals of same polarity	2,500 VAC at 50/60 Hz for 1 min
	Between each terminal and ground	2,500 VAC at 50/60 Hz for 1 min
Vibration resistance	Malfunction	10 to 55 Hz, 1.5-mm double amplitude (malfunction within 1 ms)
Shock resistance	Malfunction	1,000 m/s <sup>2</sup> max. (malfunction within 1 ms)
Durability	Mechanical	500,000 operations min. (Switches with 3 positions: 300,000 operations min.)
	Electrical	500,000 operations min. (Switches with 3 positions: 300,000 operations min.)
Ambient operating temperature* <sup>1</sup>		-25 to 70°C
Ambient operating humidity		35% to 85% RH
Ambient storage temperature* <sup>1</sup>		-40 to 80°C
Degree of protection* <sup>2</sup>		IP66, NEMA13
Electric shock protection class		Class II
PTI (tracking characteristic)		175
Degree of contamination (application environment)		3 (IEC 60947-5-1)
Weight		Approx. 65 g (for 1NC/1NO)

\*1. With no icing or condensation.

\*2. Degree of protection from the front of the panel.

### Operating Characteristics (for SPST-NO/SPST-NC)

Item	Type	Key-type Selector Switches	
		Manual reset	Automatic reset
Total travel force (torque) (maximum TTF)		0.6 N·m	0.6 N·m
Total travel (TT)		2 positions: Approx. 90°, 3 positions: Approx. 45°	
Resetting force (torque) (RF)		0.5 N·m max.	---

### Examples of Linked Contact Blocks

 Contact Blocks

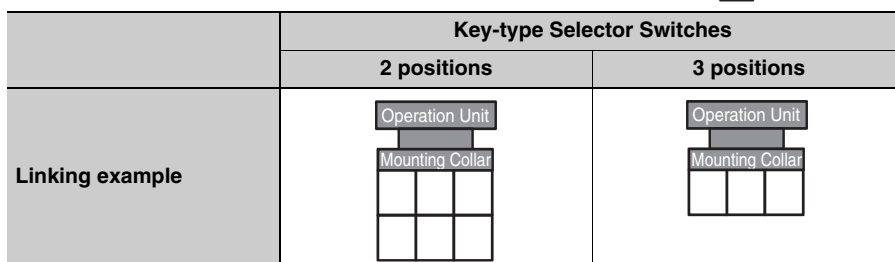

**Note:** If you increase the number of Contact Blocks, evaluate the Switch under actual working conditions before permanent installation and use the Switch within a number of switching operations that will not adversely affect the Switch's performance.

# Dimensions

## Lighted and Non-lighted Key-type Selection Switches

### Two-position Switches with Plastic Bezels

A22NK-2B

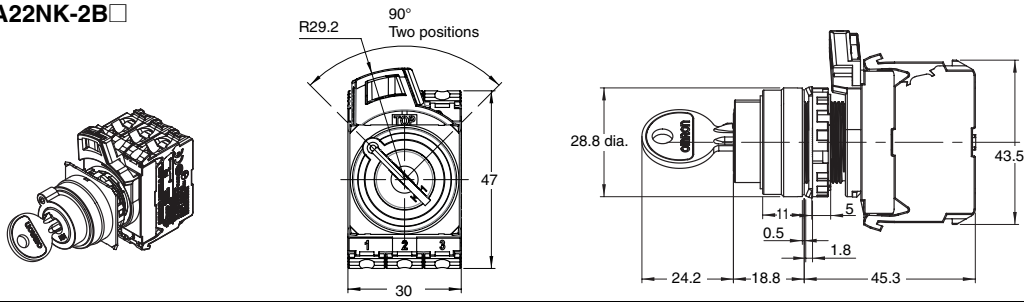

### Three-position Switches with Plastic Bezels

A22NK-3B

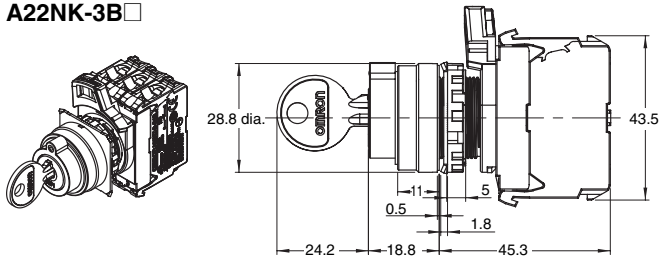

### Two-position Switches with Brushed Metal Bezels

A22NK-2M

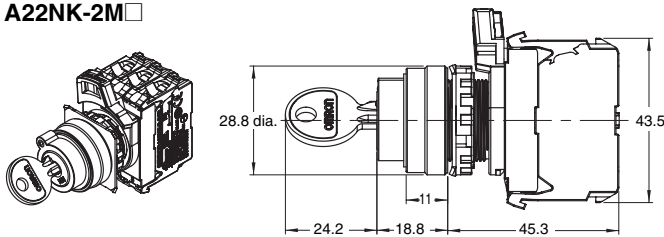

### Three-position Switches with Brushed Metal Bezels

A22NK-3M

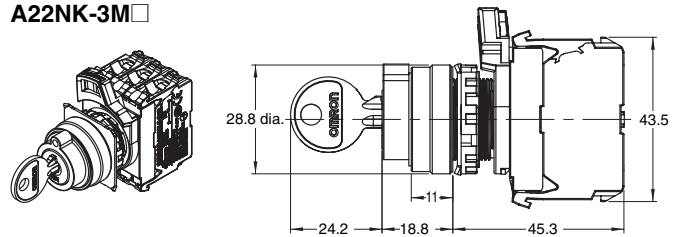

### Two-position Switches with Metal Bezels

A22NK-2R

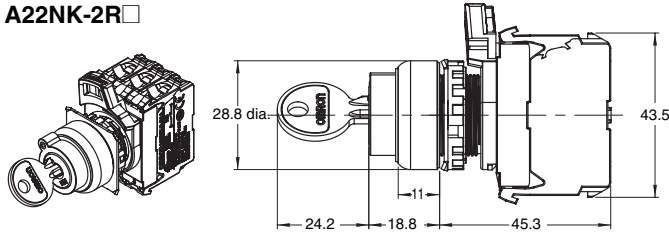

### Three-position Switches with Metal Bezels

A22NK-3R

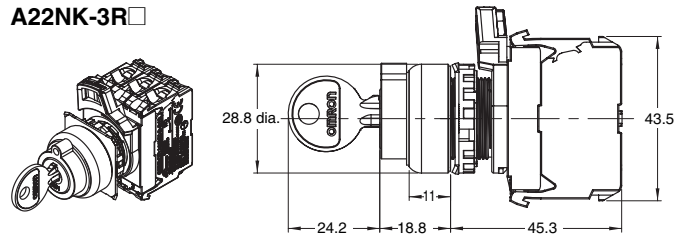

### Depth with Linked Units

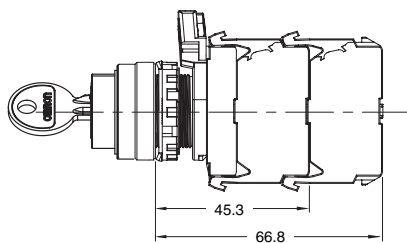

### Terminal Wiring Diagrams Bottom View

2NO/1NC  
Contact configuration  
code:112

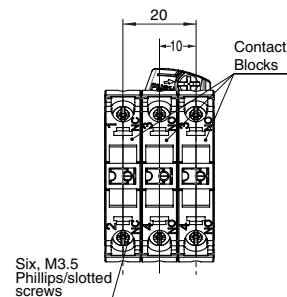

### Terminal Connection Diagrams

2NO/1NC  
Contact configuration  
code:112

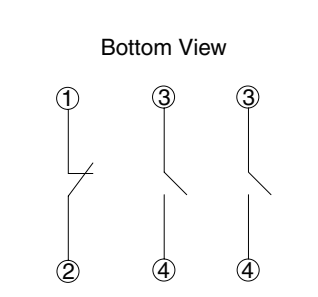

## A22NK

### Safety Precautions

---

Refer to *Safety Precautions for All Pushbutton Switches/Indicators* for common precautions.  
Read the *Safety Precautions* in the A22NN/A22NL datasheet.

<b>Precautions for Correct Use</b>
------------------------------------

Insert the key all of the way to the back of the cylinder before you turn it.

# Terms and Conditions Agreement

## **Read and understand this catalog.**

Please read and understand this catalog before purchasing the products. Please consult your OMRON representative if you have any questions or comments.

## **Warranties.**

- (a) Exclusive Warranty. Omron's exclusive warranty is that the Products will be free from defects in materials and workmanship for a period of twelve months from the date of sale by Omron (or such other period expressed in writing by Omron). Omron disclaims all other warranties, express or implied.
- (b) Limitations. OMRON MAKES NO WARRANTY OR REPRESENTATION, EXPRESS OR IMPLIED, ABOUT NON-INFRINGEMENT, MERCHANTABILITY OR FITNESS FOR A PARTICULAR PURPOSE OF THE PRODUCTS. BUYER ACKNOWLEDGES THAT IT ALONE HAS DETERMINED THAT THE PRODUCTS WILL SUITABLY MEET THE REQUIREMENTS OF THEIR INTENDED USE.

Omron further disclaims all warranties and responsibility of any type for claims or expenses based on infringement by the Products or otherwise of any intellectual property right. (c) Buyer Remedy. Omron's sole obligation hereunder shall be, at Omron's election, to (i) replace (in the form originally shipped with Buyer responsible for labor charges for removal or replacement thereof) the non-complying Product, (ii) repair the non-complying Product, or (iii) repay or credit Buyer an amount equal to the purchase price of the non-complying Product; provided that in no event shall Omron be responsible for warranty, repair, indemnity or any other claims or expenses regarding the Products unless Omron's analysis confirms that the Products were properly handled, stored, installed and maintained and not subject to contamination, abuse, misuse or inappropriate modification. Return of any Products by Buyer must be approved in writing by Omron before shipment. Omron Companies shall not be liable for the suitability or unsuitability or the results from the use of Products in combination with any electrical or electronic components, circuits, system assemblies or any other materials or substances or environments. Any advice, recommendations or information given orally or in writing, are not to be construed as an amendment or addition to the above warranty.

See <http://www.omron.com/global/> or contact your Omron representative for published information.

## **Limitation on Liability; Etc.**

OMRON COMPANIES SHALL NOT BE LIABLE FOR SPECIAL, INDIRECT, INCIDENTAL, OR CONSEQUENTIAL DAMAGES, LOSS OF PROFITS OR PRODUCTION OR COMMERCIAL LOSS IN ANY WAY CONNECTED WITH THE PRODUCTS, WHETHER SUCH CLAIM IS BASED IN CONTRACT, WARRANTY, NEGLIGENCE OR STRICT LIABILITY.

Further, in no event shall liability of Omron Companies exceed the individual price of the Product on which liability is asserted.

## **Suitability of Use.**

Omron Companies shall not be responsible for conformity with any standards, codes or regulations which apply to the combination of the Product in the Buyer's application or use of the Product. At Buyer's request, Omron will provide applicable third party certification documents identifying ratings and limitations of use which apply to the Product. This information by itself is not sufficient for a complete determination of the suitability of the Product in combination with the end product, machine, system, or other application or use. Buyer shall be solely responsible for determining appropriateness of the particular Product with respect to Buyer's application, product or system. Buyer shall take application responsibility in all cases.

NEVER USE THE PRODUCT FOR AN APPLICATION INVOLVING SERIOUS RISK TO LIFE OR PROPERTY OR IN LARGE QUANTITIES WITHOUT ENSURING THAT THE SYSTEM AS A WHOLE HAS BEEN DESIGNED TO ADDRESS THE RISKS, AND THAT THE OMRON PRODUCT(S) IS PROPERLY RATED AND INSTALLED FOR THE INTENDED USE WITHIN THE OVERALL EQUIPMENT OR SYSTEM.

## **Programmable Products.**

Omron Companies shall not be responsible for the user's programming of a programmable Product, or any consequence thereof.

## **Performance Data.**

Data presented in Omron Company websites, catalogs and other materials is provided as a guide for the user in determining suitability and does not constitute a warranty. It may represent the result of Omron's test conditions, and the user must correlate it to actual application requirements. Actual performance is subject to the Omron's Warranty and Limitations of Liability.

## **Change in Specifications.**

Product specifications and accessories may be changed at any time based on improvements and other reasons. It is our practice to change part numbers when published ratings or features are changed, or when significant construction changes are made. However, some specifications of the Product may be changed without any notice. When in doubt, special part numbers may be assigned to fix or establish key specifications for your application. Please consult with your Omron's representative at any time to confirm actual specifications of purchased Product.

## **Errors and Omissions.**

Information presented by Omron Companies has been checked and is believed to be accurate; however, no responsibility is assumed for clerical, typographical or proofreading errors or omissions.

**OMRON Corporation Industrial Automation Company**  
Tokyo, JAPAN

Contact: [www.ia.omron.com](http://www.ia.omron.com)

**Regional Headquarters**

**OMRON EUROPE B.V.**

Wegalaan 67-69, 2132 JD Hoofddorp  
The Netherlands

Tel: (31)2356-81-300/Fax: (31)2356-81-388

**OMRON ELECTRONICS LLC**

2895 Greenspoint Parkway, Suite 200  
Hoffman Estates, IL 60169 U.S.A

Tel: (1) 847-843-7900/Fax: (1) 847-843-7787

**OMRON ASIA PACIFIC PTE. LTD.**

No. 438A Alexandra Road # 05-05/08 (Lobby 2),  
Alexandra Technopark,  
Singapore 119967

Tel: (65) 6835-3011/Fax: (65) 6835-2711

**OMRON (CHINA) CO., LTD.**

Room 2211, Bank of China Tower,  
200 Yin Cheng Zhong Road,  
PuDong New Area, Shanghai, 200120, China

Tel: (86) 21-5037-2222/Fax: (86) 21-5037-2200

**Authorized Distributor:**

© OMRON Corporation 2015 All Rights Reserved.  
In the interest of product improvement,  
specifications are subject to change without notice.

CSM\_1\_1\_0415

**Cat. No. A241-E1-01**

0415 (0415)

## X-ON Electronics

Largest Supplier of Electrical and Electronic Components

*Click to view similar products for [Keylock Switches](#) category:*

*Click to view products by [Omron](#) manufacturer:*

Other Similar products are found below :

[89496-09](#) [89638-00](#) [58J9A90-01C02N](#) [719-0022-020](#) [719-0122-000](#) [719-0201-000](#) [719-0202-000](#) [719-0702-000](#) [84800-04](#) [88521-00](#)  
[GKNC33L](#) [GKNC3L](#) [PVA2OAH5](#) [14-136.025K](#) [14-235.022K](#) [AS6H-2K2A](#) [AS6M-2K1B](#) [1571487-1](#) [HW4K-2BF20](#) [JD7510H](#)  
[K6SLYE1.55NL327SD](#) [KH3C-20C](#) [89638-05](#) [A028301](#) [A165K-J2AL-2](#) [A165K-J2M-2](#) [A165K-J3AMR](#) [A165K-J3M](#) [205389 \(PAYGUARD](#)  
[BUTTON PAD\)](#) [2SWK131AL102](#) [30PA39-AML](#) [LW6MJ-2C64WWB](#) [AS6M-2K1A](#) [51-401.036D](#) [51-401.036K](#) [51-414.036D](#) [HW1K-](#)  
[3HF20](#) [4370039](#) [Y1112-2027CLFT](#) [4B01H322NCFQ](#) [51-155.025D](#) [51-195.025D](#) [51-378.AD](#) [51-404.036D](#) [51-405.036D](#) [51-415.036D](#) [1-](#)  
[1437597-8](#) [86945-05](#) [88169-05](#) [719-0204-000](#)