



Common mode filters

For high-speed signal line (MIPI C-PHY)

TCM-C series

TCM0906C_{type}

TCM0906C

0906 [0302 inch]*

* Dimensions Code JIS[EIA]

REMINDERS FOR USING THESE PRODUCTS

Before using these products, be sure to request the delivery specifications.

SAFETY REMINDERS

Please pay sufficient attention to the warnings for safe designing when using this products.

REMINDERS

- The storage period is less than 6 months. Be sure to follow the storage conditions (temperature: 5 to 40°C, humidity: 20 to 70% RH or less).
If the storage period elapses, the soldering of the terminal electrodes may deteriorate.
- Do not use or store in locations where there are conditions such as gas corrosion (salt, acid, alkali, etc.).
- Before soldering, be sure to preheat components.
The preheating temperature should be set so that the temperature difference between the solder temperature and chip temperature does not exceed 150°C.
- Soldering corrections after mounting should be within the range of the conditions determined in the specifications.
If overheated, a short circuit, performance deterioration, or lifespan shortening may occur.
- When embedding a printed circuit board where a chip is mounted to a set, be sure that residual stress is not given to the chip due to the overall distortion of the printed circuit board and partial distortion such as at screw tightening portions.
- Self heating (temperature increase) occurs when the power is turned ON, so the tolerance should be sufficient for the set thermal design.
- Carefully lay out the coil for the circuit board design of the non-magnetic shield type.
A malfunction may occur due to magnetic interference.
- Use a wrist band to discharge static electricity in your body through the grounding wire.
- Do not expose the products to magnets or magnetic fields.
- Do not use for a purpose outside of the contents regulated in the delivery specifications.
- The products listed on this catalog are intended for use in general electronic equipment (AV equipment, telecommunications equipment, home appliances, amusement equipment, computer equipment, personal equipment, office equipment, measurement equipment, industrial robots) under a normal operation and use condition.
The products are not designed or warranted to meet the requirements of the applications listed below, whose performance and/or quality require a more stringent level of safety or reliability, or whose failure, malfunction or trouble could cause serious damage to society, person or property.
If you intend to use the products in the applications listed below or if you have special requirements exceeding the range or conditions set forth in the each catalog, please contact us.

- (1) Aerospace/aviation equipment
- (2) Transportation equipment (cars, electric trains, ships, etc.)
- (3) Medical equipment
- (4) Power-generation control equipment
- (5) Atomic energy-related equipment
- (6) Seabed equipment
- (7) Transportation control equipment

- (8) Public information-processing equipment
- (9) Military equipment
- (10) Electric heating apparatus, burning equipment
- (11) Disaster prevention/crime prevention equipment
- (12) Safety equipment
- (13) Other applications that are not considered general-purpose applications

When designing your equipment even for general-purpose applications, you are kindly requested to take into consideration securing protection circuit/device or providing backup circuits in your equipment.

Common mode filters

For high-speed signal line (MIPI C-PHY)

Product compatible with RoHS directive

Halogen-free

Compatible with lead-free solders

Overview of TCM0906C type

FEATURES

- This product is a thin-film common-mode filter compatible with the MIPI C-PHY used as an interface for cameras or displays installed in mobile terminals.
- By ensuring common mode impedance, the signal transmission characteristics of each line are balanced while exerting a high noise suppression effect, and this has little effect on high-speed transmission signals.
- 0906 (0.875×0.650×0.300mm, dimensional tolerance ±0.05mm), small thin film common mode filter with three lines.

APPLICATION

Anti-noise measures for high-speed differential transmission lines (MIPI C-PHY) for mobile devices such as smart phones and tablet terminals

PART NUMBER CONSTRUCTION

TCM	0906	C	-	400	-	3P	-	T	200	
Series name	LxWxT dimensions (mm)		Product internal code	Impedance (Ω) at 100MHz		Number of lines		Packaging style		Internal code
	0906	0.875×0.65×0.4	C	40	100	3P	3 lines	T	Taping	

OPERATING TEMPERATURE RANGE, PACKAGE QUANTITY, PRODUCT WEIGHT

Type	Temperature range		Package quantity (pieces/reel)	Individual weight (mg)
	Operating temperature* (°C)	Storage temperature** (°C)		
TCM0906C	-25 to +85	-25 to +85	10000	1.4

* Operating temperature range includes self-temperature rise.

** The storage temperature range is for after the circuit board is mounted.

○ RoHS Directive Compliant Product: See the following for more details. <https://product.tdk.com/info/en/environment/rohs/index.html>

○ Halogen-free: indicates that Cl content is less than 900ppm, Br content is less than 900ppm, and that the total Cl and Br content is less than 1500ppm.

 Please be sure to request delivery specifications that provide further details on the features and specifications of the products for proper and safe use. Please note that the contents may change without any prior notice due to reasons such as upgrading.

TCM0906C type

RECOMMENDED REFLOW PROFILE

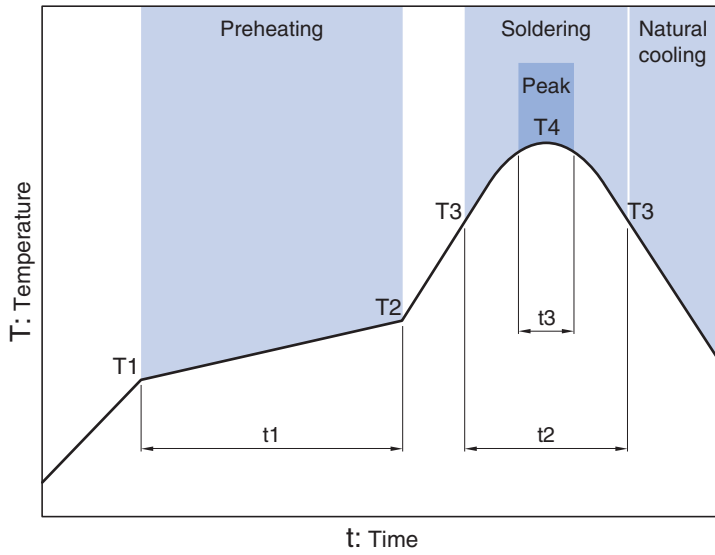

Preheating			Soldering		Peak	
Temp.		Time	Temp.	Time	Temp.	Time
T1	T2	t1	T3	t2	T4	t3
150°C	180°C	60 to 120s	230°C	10 to 30s	245°C	5s max.

TCM0906C type

SHAPE & DIMENSIONS

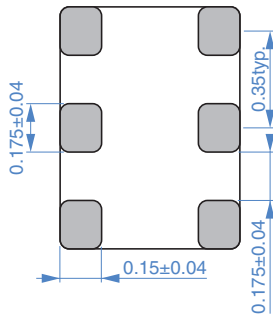
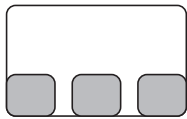
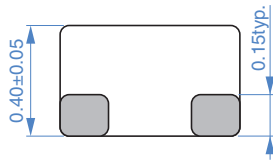
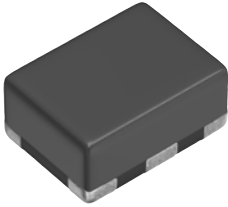
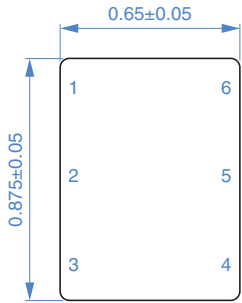

Dimensions in mm

RECOMMENDED LAND PATTERN

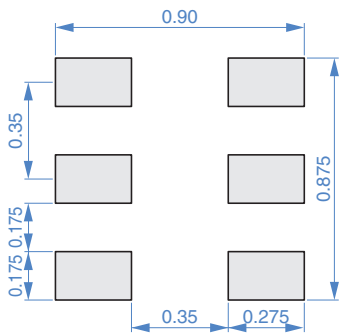

Dimensions in mm

CIRCUIT DIAGRAM

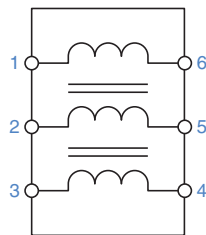

• No directionality

 Please be sure to request delivery specifications that provide further details on the features and specifications of the products for proper and safe use. Please note that the contents may change without any prior notice due to reasons such as upgrading.

TCM0906C type

ELECTRICAL CHARACTERISTICS

CHARACTERISTICS SPECIFICATION TABLE

Common mode attenuation (dB)	DC resistance [1 line] (Ω)	Cutoff frequency (GHz)typ.	Common mode impedance [100MHz] (Ω)typ.	Rated current (mA)	Rated voltage (V)	Insulation resistance (MΩ)min.	Part No.
18 min: @800M to 1.0GHz 20 min: @1.0G to 1.6GHz	Line1 : 3.0+/-30% Line2 : 2.2+/-30% Line3 : 3.0+/-30%	5.0	40	100	5	10	TCM0906C-400-3P-T200

Measurement equipment

Measurement item	Product No.	Manufacturer
Common mode attenuation	E5071B	Keysight Technologies
DC resistance	4338A	Keysight Technologies
Insulation resistance	4339A	Keysight Technologies

* Equivalent measurement equipment may be used.

TCM0906C type

ELECTRICAL CHARACTERISTICS

INSERTION LOSS VS. FREQUENCY CHARACTERISTICS

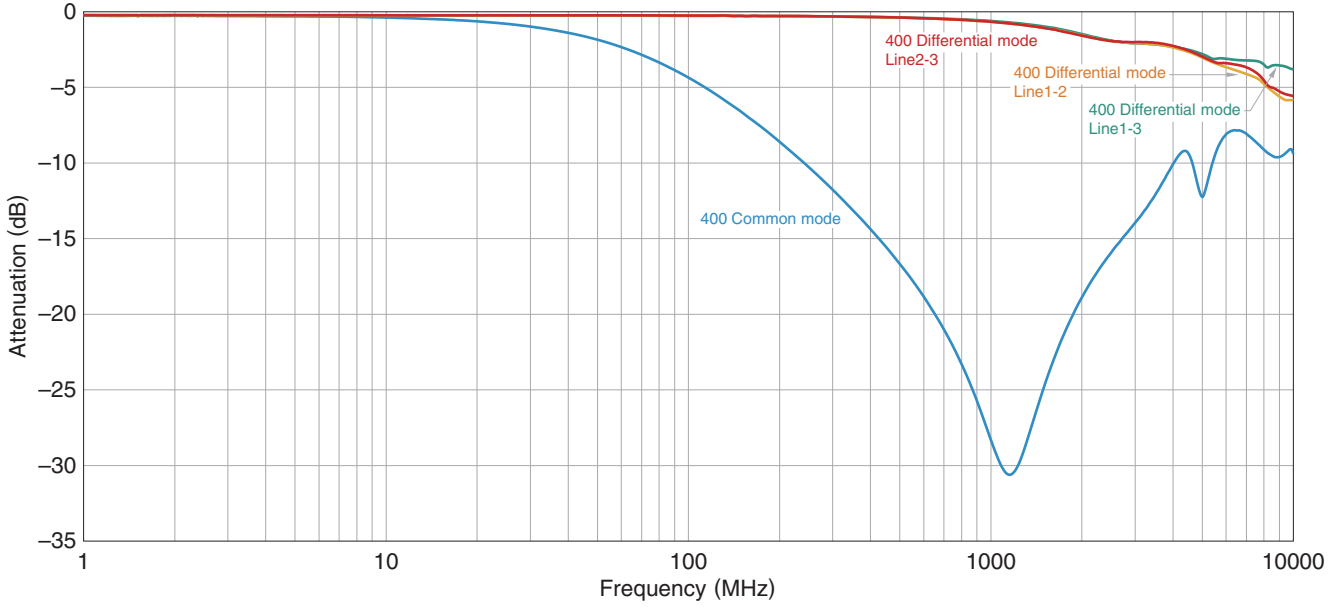

○ Measurement equipment

Product No.	Manufacturer
E5071B	Keysight Technologies

* Equivalent measurement equipment may be used.

 Please be sure to request delivery specifications that provide further details on the features and specifications of the products for proper and safe use.
Please note that the contents may change without any prior notice due to reasons such as upgrading.

TCM0906C type

PACKAGING STYLE

REEL DIMENSIONS

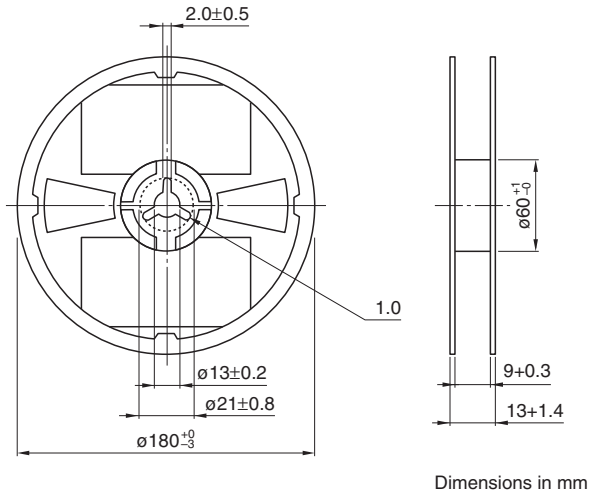

TAPE DIMENSIONS

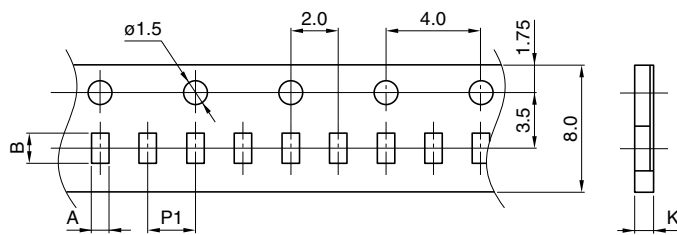

Type	A	B	P1	K
TCM0906C	0.96	0.74	2.0	0.50

