

FEATURES

- **Very Low Dropout:**
 90mV at 150mA
 30mV at 50mA (LTC1844-3.3)
- **Wide Input Voltage Range: 1.6V to 6.5V**
- **Low 35 μ A Supply Current, Even in Dropout**
- **Low Noise: 60 μ V_{RMS} (10Hz to 100kHz)**
- **\pm 1.75% Voltage Accuracy Over Temperature, Voltage and Current Ranges**
- **Fast Transient Response**
- **10nA Supply Current in Shutdown**
- **Fixed Output Voltages: 1.5V, 1.8V, 2.5V, 2.8V, 3.3V**
- **Adjustable Output Voltage: 1.25V to 6V**
- **Output Current Limit**
- **Reverse-Battery and Reverse-Current Protection**
- **No Protection Diodes Needed**
- **Stable with 1 μ F Output Capacitor**
- **Stable with Ceramic Capacitors**
- **Short-Circuit and Thermal Overload Protection**
- **Low Profile (1mm) SOT-23 Package**

APPLICATIONS

- Portable Instruments and Battery-Powered Systems
- Bluetooth/802.11 Cards
- Cellular Phones
- PDAs and Notebook Computers

DESCRIPTION

The LTC[®]1844 Series are low noise VLDO[™] (very low dropout) linear regulators designed for low power/portable applications. These regulators can operate from input voltages as low as 1.6V. Typical output noise is only 30 μ V_{RMS} and typical dropout for the LTC1844-3.3 is just 90mV at the maximum load current of 150mA, reducing to 30mV at 50mA.

The internal P-channel MOSFET pass transistor requires no base current, allowing the device to draw only 35 μ A during normal operation, independent of the dropout voltage and load current. The quiescent current falls to a negligible 10nA during shutdown.

Other features include high output voltage accuracy, excellent transient response, stability with ultralow ESR ceramic capacitors as small as 1 μ F, reverse-battery and reverse-current protection, short-circuit and thermal overload protection and output current limiting.

The LTC1844 regulators are available in a low profile (1mm) SOT-23 (ThinSOT[™]) package.

LT, LTC and LT are registered trademarks of Linear Technology Corporation. VLDO and ThinSOT are trademarks of Linear Technology Corporation. All other trademarks are the property of their respective owners.

TYPICAL APPLICATION

Fixed Voltage Low Noise, VLDO Linear Regulator

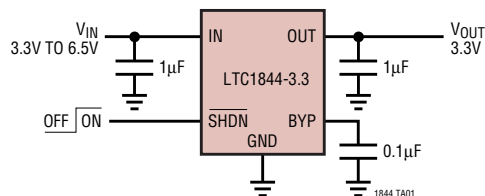

LTC1844-3.3 Dropout Voltage vs Load Current

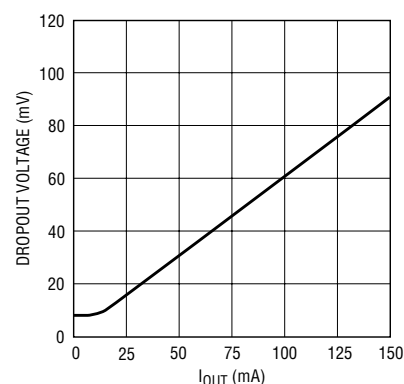

1844 TA02

1844fa

LTC1844 Series

ABSOLUTE MAXIMUM RATINGS (Note 1)

| | | | |
|---------------------------|-------------|--|----------------|
| Supply Voltage (IN) | -7V to 7V | Output Short-Circuit Duration | Indefinite |
| Input Voltage | | Operating Junction Temperature Range | |
| SHDN, BYP, ADJ | -0.3V to 7V | (Notes 2, 10) | -40°C to 125°C |
| Output Voltage | | Storage Temperature Range | -65°C to 150°C |
| OUT | -0.3V to 7V | Lead Temperature (Soldering, 10 sec) | 300°C |
| OUT to IN | -7V to 7V | | |

PACKAGE/ORDER INFORMATION

| <p>S5 PACKAGE 5-LEAD PLASTIC TSOT-23 $T_{JMAX} = 125^{\circ}\text{C}$, $\theta_{JA} = 250^{\circ}\text{C/W}$, $\theta_{JC} = 90^{\circ}\text{C/W}$ SEE THE APPLICATIONS INFORMATION SECTION</p> | | <p>S5 PACKAGE 5-LEAD PLASTIC TSOT-23 $T_{JMAX} = 125^{\circ}\text{C}$, $\theta_{JA} = 250^{\circ}\text{C/W}$, $\theta_{JC} = 90^{\circ}\text{C/W}$ SEE THE APPLICATIONS INFORMATION SECTION</p> | | <p>S5 PACKAGE 5-LEAD PLASTIC TSOT-23 $T_{JMAX} = 125^{\circ}\text{C}$, $\theta_{JA} = 250^{\circ}\text{C/W}$, $\theta_{JC} = 90^{\circ}\text{C/W}$ SEE THE APPLICATIONS INFORMATION SECTION</p> | |
|--|-----------------|--|-----------------|--|-----------------|
| ORDER PART NUMBER | S5 PART MARKING | ORDER PART NUMBER | S5 PART MARKING | ORDER PART NUMBER | S5 PART MARKING |
| LTC1844ES5-1.5 | LTF1 | LTC1844ES5-SD | LTE8 | LTC1844ES5-BYP | LTE9 |
| LTC1844ES5-1.8 | LTF2 | | | | |
| LTC1844ES5-2.5 | LTF3 | | | | |
| LTC1844ES5-2.8 | LTQK | | | | |
| LTC1844ES5-3.3 | LTF4 | | | | |
| Order Options Tape and Reel: Add #TR Lead Free: Add #PBF Lead Free Tape and Reel: Add #TRPBF Lead Free Part Marking: http://www.linear.com/leadfree/ | | | | | |

Consult LTC Marketing for parts specified with wider operating temperature ranges.

ELECTRICAL CHARACTERISTICS

The ● denotes specifications which apply over the full operating temperature range, otherwise specifications are at $T_A = 25^{\circ}\text{C}$. $V_{IN} = V_{OUT} + 0.5\text{V}$, unless otherwise noted. (Note 2)

| SYMBOL | PARAMETER | CONDITIONS | MIN | TYP | MAX | UNITS |
|--------------|--|--|-------|-------|------|---------------|
| V_{IN} | Input Voltage | | ● 1.6 | | 6.5 | V |
| I_{IN} | Quiescent Current | $\overline{\text{SHDN}} = V_{IN}$ | | 35 | 55 | μA |
| | | | ● | | 80 | μA |
| I_{INSHDN} | V_{IN} Shutdown Supply Current | $\overline{\text{SHDN}} = 0\text{V}$ | ● | 0.01 | 1 | μA |
| $V_{OUT\%}$ | Regulated Output Voltage (Notes 3, 4, 5) | LTC1844-3.3 $V_{IN} = 3.8\text{V to }6.5\text{V}$, $I_{OUT} = 0\text{mA to }150\text{mA}$ | ● | -1.50 | 1.50 | $\%V_{OUT}$ |
| | | LTC1844-3.3 $V_{IN} = 3.8\text{V to }6.5\text{V}$, $I_{OUT} = 0\text{mA to }150\text{mA}$ | ● | -1.75 | 1.75 | $\%V_{OUT}$ |
| | | LTC1844-2.8 $V_{IN} = 3.3\text{V to }6.5\text{V}$, $I_{OUT} = 0\text{mA to }150\text{mA}$ | ● | -1.50 | 1.50 | $\%V_{OUT}$ |
| | | LTC1844-2.8 $V_{IN} = 3.3\text{V to }6.5\text{V}$, $I_{OUT} = 0\text{mA to }150\text{mA}$ | ● | -1.75 | 1.75 | $\%V_{OUT}$ |
| | | LTC1844-2.5 $V_{IN} = 3.0\text{V to }6.5\text{V}$, $I_{OUT} = 0\text{mA to }150\text{mA}$ | ● | -1.50 | 1.50 | $\%V_{OUT}$ |
| | | LTC1844-2.5 $V_{IN} = 3.0\text{V to }6.5\text{V}$, $I_{OUT} = 0\text{mA to }150\text{mA}$ | ● | -1.75 | 1.75 | $\%V_{OUT}$ |
| | | LTC1844-1.8 $V_{IN} = 2.3\text{V to }6.5\text{V}$, $I_{OUT} = 0\text{mA to }150\text{mA}$ | ● | -1.50 | 1.50 | $\%V_{OUT}$ |
| | | LTC1844-1.8 $V_{IN} = 2.3\text{V to }6.5\text{V}$, $I_{OUT} = 0\text{mA to }150\text{mA}$ | ● | -1.75 | 1.75 | $\%V_{OUT}$ |

1844fa

ELECTRICAL CHARACTERISTICS

The ● denotes specifications which apply over the full operating temperature range, otherwise specifications are at $T_A = 25^\circ\text{C}$. $V_{IN} = V_{OUT} + 0.5\text{V}$, unless otherwise noted. (Note 2)

| SYMBOL | PARAMETER | CONDITIONS | MIN | TYP | MAX | UNITS | | | |
|--|------------------------------|---|------------------------------|---|------|-------------|------|-------|---|
| | | LTC1844-1.5 $V_{IN} = 2.0\text{V to } 6.5\text{V}$, $I_{OUT} = 0\text{mA to } 150\text{mA}$ | | -1.50 | 1.50 | % V_{OUT} | | | |
| | | LTC1844-1.5 $V_{IN} = 2.2\text{V to } 6.5\text{V}$, $I_{OUT} = 0\text{mA to } 150\text{mA}$ | ● | -2.00 | 2.00 | % V_{OUT} | | | |
| | | LTC1844-1.5 $V_{IN} = 2.0\text{V to } 6.5\text{V}$, $I_{OUT} = 0\text{mA to } 100\text{mA}$ | ● | -2.50 | 2.00 | % V_{OUT} | | | |
| | | LTC1844-BYP $V_{IN} = 1.75\text{V to } 6.5\text{V}$, $I_{OUT} = 0\text{mA to } 150\text{mA}$ | | -1.50 | 1.50 | % V_{OUT} | | | |
| | | LTC1844-BYP $V_{IN} = 2.2\text{V to } 6.5\text{V}$, $I_{OUT} = 0\text{mA to } 150\text{mA}$ | ● | -1.75 | 1.75 | % V_{OUT} | | | |
| | | LTC1844-BYP $V_{IN} = 1.75\text{V to } 6.5\text{V}$, $I_{OUT} = 0\text{mA to } 100\text{mA}$ | ● | -3.50 | 1.75 | % V_{OUT} | | | |
| | | LTC1844-SD $V_{IN} = 1.75\text{V to } 6.5\text{V}$, $I_{OUT} = 0\text{mA to } 150\text{mA}$ | | -1.50 | 1.50 | % V_{OUT} | | | |
| | | LTC1844-SD $V_{IN} = 2.2\text{V to } 6.5\text{V}$, $I_{OUT} = 0\text{mA to } 150\text{mA}$ | ● | -1.75 | 1.75 | % V_{OUT} | | | |
| | | LTC1844-SD $V_{IN} = 1.75\text{V to } 6.5\text{V}$, $I_{OUT} = 0\text{mA to } 100\text{mA}$ | ● | -3.50 | 1.75 | % V_{OUT} | | | |
| | | V_{ADJ} | ADJ Pin Voltage (Notes 3, 5) | LTC1844-BYP $V_{IN} = 1.75\text{V to } 6.5\text{V}$, $I_{OUT} = 0\text{mA to } 150\text{mA}$ | | 1.233 | 1.25 | 1.271 | V |
| | | | | LTC1844-BYP $V_{IN} = 2.2\text{V to } 6.5\text{V}$, $I_{OUT} = 0\text{mA to } 150\text{mA}$ | ● | 1.230 | | 1.274 | V |
| | | | | LTC1844-BYP $V_{IN} = 1.75\text{V to } 6.5\text{V}$, $I_{OUT} = 0\text{mA to } 100\text{mA}$ | ● | 1.208 | | 1.274 | V |
| LTC1844-SD $V_{IN} = 1.75\text{V to } 6.5\text{V}$, $I_{OUT} = 0\text{mA to } 150\text{mA}$ | | | | 1.233 | 1.25 | 1.271 | V | | |
| LTC1844-SD $V_{IN} = 2.2\text{V to } 6.5\text{V}$, $I_{OUT} = 0\text{mA to } 150\text{mA}$ | ● | | | 1.230 | | 1.274 | V | | |
| LTC1844-SD $V_{IN} = 1.75\text{V to } 6.5\text{V}$, $I_{OUT} = 0\text{mA to } 100\text{mA}$ | ● | | | 1.208 | | 1.274 | V | | |
| ΔV_{LNR} | Line Regulation (Notes 3, 5) | LTC1844-3.3 $V_{IN} = 3.4\text{V to } 6.5\text{V}$, $I_L = 1\text{mA}$ | ● | 4 | 20 | mV | | | |
| | | LTC1844-2.8 $V_{IN} = 2.9\text{V to } 6.5\text{V}$, $I_L = 1\text{mA}$ | ● | 4 | 20 | mV | | | |
| | | LTC1844-2.5 $V_{IN} = 2.6\text{V to } 6.5\text{V}$, $I_L = 1\text{mA}$ | ● | 4 | 20 | mV | | | |
| | | LTC1844-1.8 $V_{IN} = 2.2\text{V to } 6.5\text{V}$, $I_L = 1\text{mA}$ | ● | 4 | 20 | mV | | | |
| | | $V_{IN} = 1.9\text{V to } 6.5\text{V}$, $I_L = 1\text{mA}$ | | 4 | 20 | mV | | | |
| | | $V_{IN} = 1.9\text{V to } 6.5\text{V}$, $I_L = 1\text{mA}$ | ● | 4 | 30 | mV | | | |
| | | LTC1844-1.5 $V_{IN} = 2.2\text{V to } 6.5\text{V}$, $I_L = 1\text{mA}$ | ● | 4 | 20 | mV | | | |
| | | $V_{IN} = 1.6\text{V to } 6.5\text{V}$, $I_L = 1\text{mA}$ | | 4 | 20 | mV | | | |
| | | $V_{IN} = 1.6\text{V to } 6.5\text{V}$, $I_L = 1\text{mA}$ | ● | 4 | 80 | mV | | | |
| | | LTC1844-BYP $V_{IN} = 2.2\text{V to } 6.5\text{V}$, $I_L = 1\text{mA}$ | ● | 4 | 20 | mV | | | |
| $V_{IN} = 1.6\text{V to } 6.5\text{V}$, $I_L = 1\text{mA}$ | | 4 | 20 | mV | | | | | |
| $V_{IN} = 1.6\text{V to } 6.5\text{V}$, $I_L = 1\text{mA}$ | ● | 4 | 80 | mV | | | | | |
| LTC1844-SD $V_{IN} = 2.2\text{V to } 6.5\text{V}$, $I_L = 1\text{mA}$ | ● | 4 | 20 | mV | | | | | |
| $V_{IN} = 1.6\text{V to } 6.5\text{V}$, $I_L = 1\text{mA}$ | | 4 | 20 | mV | | | | | |
| $V_{IN} = 1.6\text{V to } 6.5\text{V}$, $I_L = 1\text{mA}$ | ● | 4 | 80 | mV | | | | | |
| ΔV_{LDR} | Load Regulation (Notes 3, 5) | LTC1844-3.3 $V_{IN} = 3.8\text{V}$, $I_{OUT} = 0\text{mA to } 150\text{mA}$ | ● | 9 | 20 | mV | | | |
| | | LTC1844-2.8 $V_{IN} = 3.3\text{V}$, $I_{OUT} = 0\text{mA to } 150\text{mA}$ | ● | 9 | 20 | mV | | | |
| | | LTC1844-2.5 $V_{IN} = 3.0\text{V}$, $I_{OUT} = 0\text{mA to } 150\text{mA}$ | ● | 9 | 20 | mV | | | |
| | | LTC1844-1.8 $V_{IN} = 2.3\text{V}$, $I_{OUT} = 0\text{mA to } 150\text{mA}$ | ● | 9 | 20 | mV | | | |
| | | LTC1844-1.5 $V_{IN} = 2.2\text{V}$, $I_{OUT} = 0\text{mA to } 150\text{mA}$ | ● | 9 | 20 | mV | | | |
| | | $V_{IN} = 2.0\text{V}$, $I_{OUT} = 0\text{mA to } 100\text{mA}$ | ● | 9 | 40 | mV | | | |
| | | LTC1844-BYP $V_{IN} = 2.2\text{V}$, $I_{OUT} = 0\text{mA to } 150\text{mA}$ | ● | 9 | 20 | mV | | | |
| | | $V_{IN} = 1.75\text{V}$, $I_{OUT} = 0\text{mA to } 100\text{mA}$ | ● | 9 | 50 | mV | | | |
| LTC1844-SD $V_{IN} = 2.2\text{V}$, $I_{OUT} = 0\text{mA to } 150\text{mA}$ | ● | 9 | 20 | mV | | | | | |
| $V_{IN} = 1.75\text{V}$, $I_{OUT} = 0\text{mA to } 100\text{mA}$ | ● | 9 | 50 | mV | | | | | |
| ΔV_{DO} | Dropout Voltage (Notes 6, 7) | LTC1844-3.3 $I_{OUT} = 50\text{mA}$ | ● | 30 | 55 | mV | | | |
| | | $I_{OUT} = 150\text{mA}$ | ● | 90 | 150 | mV | | | |
| | | LTC1844-2.8 $I_{OUT} = 50\text{mA}$ | ● | 35 | 60 | mV | | | |
| | | $I_{OUT} = 150\text{mA}$ | ● | 105 | 165 | mV | | | |
| | | LTC1844-2.5 $I_{OUT} = 50\text{mA}$ | ● | 45 | 75 | mV | | | |
| | | $I_{OUT} = 150\text{mA}$ | ● | 135 | 200 | mV | | | |
| | | LTC1844-1.8 $I_{OUT} = 50\text{mA}$ | ● | 85 | 120 | mV | | | |
| | | $I_{OUT} = 150\text{mA}$ | ● | 230 | 300 | mV | | | |

LTC1844 Series

ELECTRICAL CHARACTERISTICS

The ● denotes specifications which apply over the full operating temperature range, otherwise specifications are at $T_A = 25^\circ\text{C}$. $V_{IN} = V_{OUT} + 0.5\text{V}$, unless otherwise noted. (Note 2)

| SYMBOL | PARAMETER | CONDITIONS | MIN | TYP | MAX | UNITS | |
|-------------------|--|---|--------|------------|------------|--|---|
| | | LTC1844-1.5 $I_{OUT} = 50\text{mA}$ $I_{OUT} = 150\text{mA}$ | ● ● | 115 350 | 160 450 | mV mV | |
| | | LTC1844-BYP $I_{OUT} = 50\text{mA}$ $I_{OUT} = 150\text{mA}$ | ● ● | 45 135 | 75 200 | mV mV | |
| | | LTC1844-SD $I_{OUT} = 50\text{mA}$ $I_{OUT} = 150\text{mA}$ | ● ● | 45 135 | 75 200 | mV mV | |
| I_{LIM} | Output Current Limit | | ● | 160 | 350 | mA | |
| e_n | Output Voltage Noise | $f = 10\text{Hz}$ to 100kHz , $C_{BP} = 0.1\mu\text{F}$, $C_{OUT} = 10\mu\text{F}$, $I_L = 150\text{mA}$ $f = 10\text{Hz}$ to 100kHz , $C_{BP} = 0.1\mu\text{F}$, $C_{OUT} = 1\mu\text{F}$, $I_L = 150\text{mA}$ | | 60 65 | | μV_{RMS} μV_{RMS} | |
| V_{SHDN} | SHDN Input Threshold | | ● | 0.35 | 0.65 | 0.9 | V |
| t_{DELAY} | Shutdown Exit Delay | $C_{BP} = 0.01\mu\text{F}$, $C_{OUT} = 1\mu\text{F}$, No load $C_{BP} = 0.01\mu\text{F}$, $C_{OUT} = 1\mu\text{F}$, No load | ● | 70 | 100 200 | μs μs | |
| T_{SHDN} | Thermal Shutdown Limit | | | 155 | | $^\circ\text{C}$ | |
| ΔT_{SHDN} | Thermal Shutdown Hysteresis | | | 10 | | $^\circ\text{C}$ | |
| I_{ADJ} | ADJ Pin Bias Current | (Notes 3, 8) | ● | 30 | 100 | nA | |
| I_{IRL} | Input Reverse Leakage Current | LTC1844-3.3, LTC1844-2.8, LTC1844-2.5, LTC1844-1.8, LTC1844-1.5, $V_{IN} = -5\text{V}$, $V_{OUT} = 0\text{V}$ | ● | 200 | 500 | μA | |
| | | LTC1844-BYP, LTC1844-SD, $V_{IN} = -5\text{V}$, $V_{OUT} = 0\text{V}$ | ● | 1000 | 1500 | μA | |
| I_{ORL} | Output Reverse Leakage Current (Note 9) | $V_{IN} = 0\text{V}$, $V_{OUT} = V_{OUT(NOMINAL)}$ $V_{IN} = 0\text{V}$, $V_{OUT} = V_{OUT(NOMINAL)}$ | ● | 0.01 | 0.1 1.2 | μA μA | |
| | | | | | | | |
| V_{OSH} | Start-Up Overshoot | $R_L = 1\text{k}$, SHDN Rise Time $\leq 1\mu\text{s}$ | | 2 | | $\%V_{OUT}$ | |
| V_{RP} | Output Ripple Rejection | $(V_{IN} - V_{OUT}) = 1\text{V (Avg)}$, $V_{RIPPLE} = 0.5\text{V}_{P-P}$, $f_{RIPPLE} = 120\text{Hz}$, $I_{LOAD} = 100\text{mA}$ | | 50 | | dB | |

Note 1: Absolute Maximum Ratings are those values beyond which the life of a device may be impaired.

Note 2: The LTC1844 is tested and specified under pulse load conditions such that $T_J \approx T_A$. The LTC1844E is guaranteed to meet performance specifications from 0°C to 70°C . Specifications over the -40°C to 125°C operating junction temperature range are assured by design, characterization and correlation with statistical process controls.

Note 3: The LTC1844 adjustable versions are tested and specified for these conditions with the ADJ pin connected to the OUT pin for a $V_{OUT(NOMINAL)}$ of 1.25V.

Note 4: Operating conditions are limited by maximum junction temperature. The regulated output voltage specification will not apply for all possible combinations of input voltage and output current. When operating at maximum input voltage, the output current range must be limited. When operating at maximum output current, the input voltage range must be limited.

Note 5: The LTC1844's high precision degrades slightly at high temperatures ($T_J > 70^\circ\text{C}$) with input voltages below 2.2V. The lower output voltage versions have been split into higher and lower accuracy input voltage ranges to reflect this.

Note 6: To ensure adequate input supply voltage, the LTC1844 adjustable versions are tested and specified for these conditions with an external resistor divider (two 100k resistors) for an output voltage of 2.50V. The external resistor divider will add a $5\mu\text{A}$ load on the output.

Note 7: Dropout voltage is $(V_{IN} - V_{OUT})$ when V_{OUT} falls to 100mV below its nominal value measured at $V_{IN} = V_{OUT} + 0.5\text{V}$. For example, the LTC1844-3.3 is tested by measuring the V_{OUT} at $V_{IN} = 3.8\text{V}$, then V_{IN} is lowered until V_{OUT} falls 100mV below the measured value. The difference $(V_{IN} - V_{OUT})$ is then measured and defined as ΔV_{DO} .

Note 8: ADJ pin bias current flows into the ADJ pin.

Note 9: Output reverse leakage current is tested with the IN pin grounded and the OUT pin forced to the rated output voltage.

Note 10: This IC includes overtemperature protection that is intended to protect the device during momentary overload conditions. Junction temperature will exceed 125°C when overtemperature protection is active. Continuous operation above the specified maximum operating junction temperature may impair device reliability.

TYPICAL PERFORMANCE CHARACTERISTICS

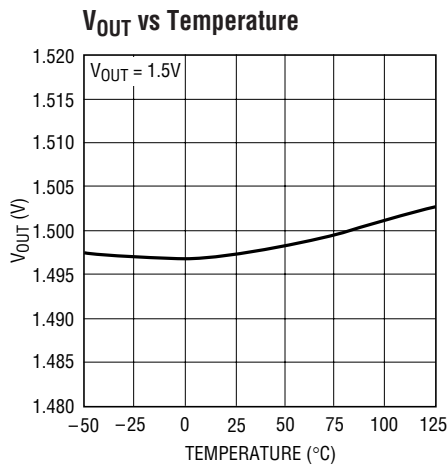

1844 G01

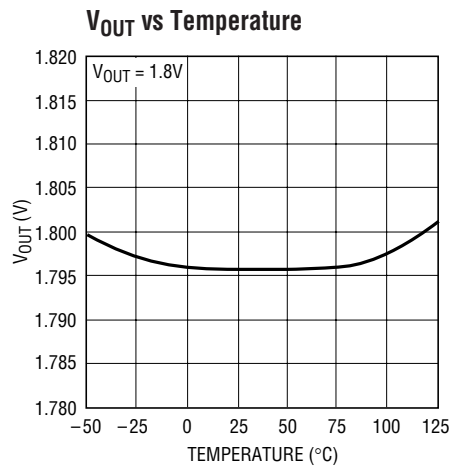

1844 G02

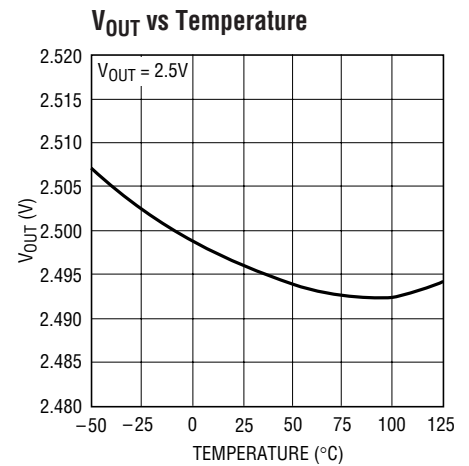

1844 G03

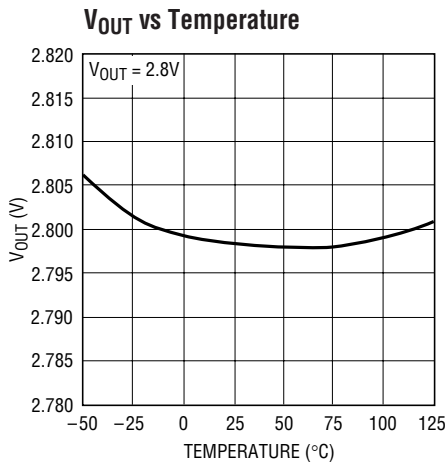

1844 G04

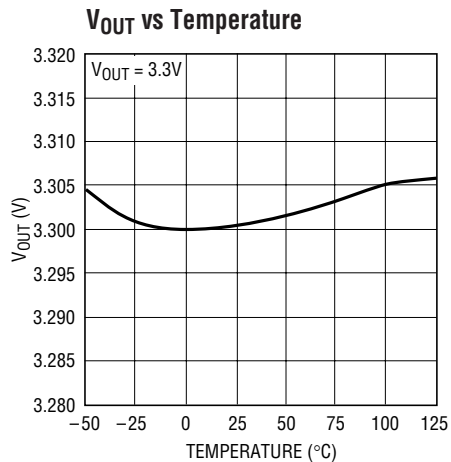

1844 G05

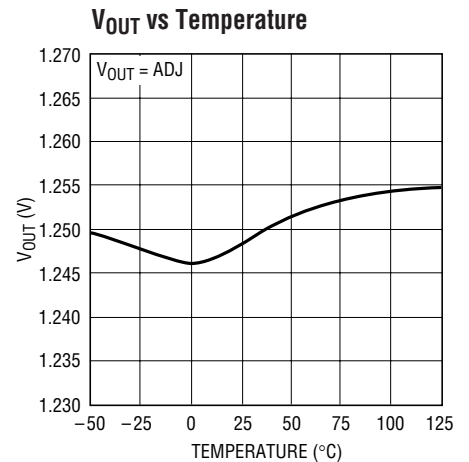

1844 G06

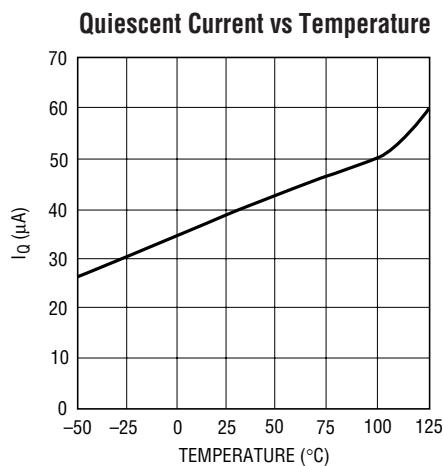

1844 G07

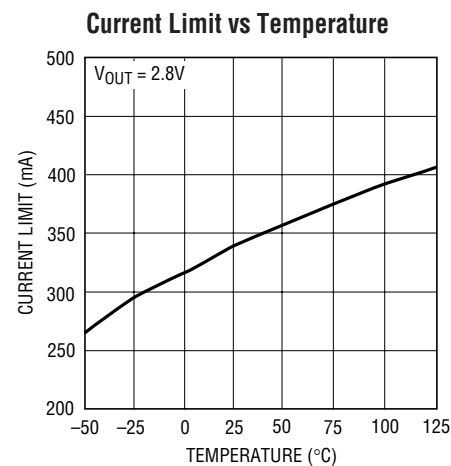

1844 G08

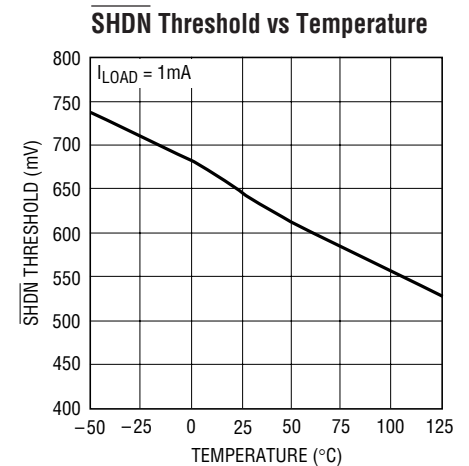

1844 G09

TYPICAL PERFORMANCE CHARACTERISTICS

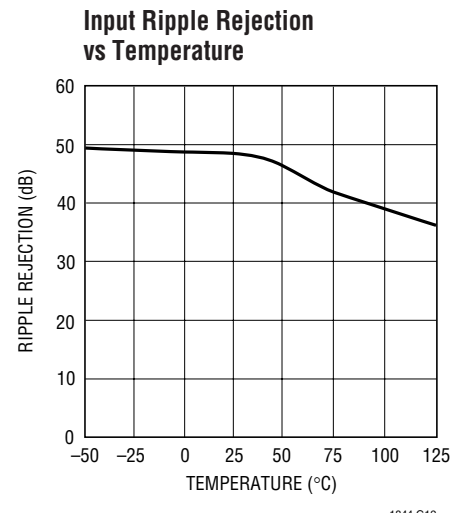
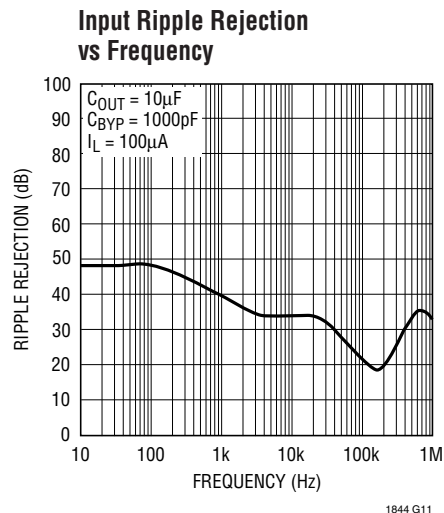
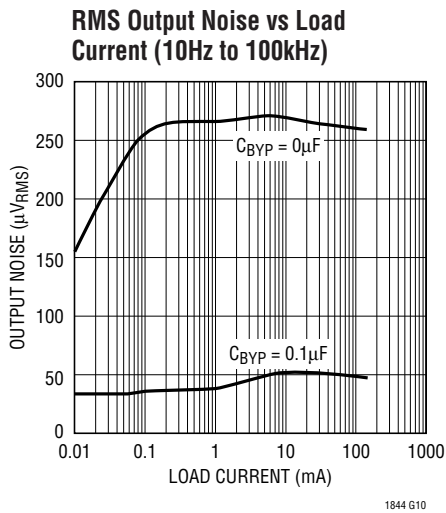

PIN FUNCTIONS

IN (Pin 1): Power for LTC1844 and Load. Power is supplied to the device through the IN pin. The IN pin should be locally bypassed to ground if the LTC1844 is more than a few inches away from another source of bulk capacitance. In general, the output impedance of a battery rises with frequency, so it is usually advisable to include an input bypass capacitor in battery-powered circuits. A capacitor in the range of $0.1\mu\text{F}$ to $1\mu\text{F}$ is usually sufficient. The LTC1844 is designed to withstand reverse voltages on the IN pin with respect to both ground and the output pin. In the case of a reversed input, which can happen if a battery is plugged in backwards, the LTC1844 will act as if there is a large resistor in series with its input and only a small amount of current will flow.

GND (Pin 2): Ground and Heat Sink. Solder to a ground plane or large pad to maximize heat dissipation.

SHDN (Pin 3, Fixed and SD Devices): Shutdown, Active Low. This pin is used to put the LTC1844 into shutdown. The SHDN pin current is typically less than 10nA . The SHDN pin cannot be left floating and must be tied to the input pin if not used. If reverse-battery protection is desired, the SHDN pin must be tied to the input pin through a large value resistor ($10\text{k}\Omega$ to $1\text{M}\Omega$).

ADJ (Pin 4, Adjustable Devices): Output Adjust. For the adjustable versions of the LTC1844, this is the input to the error amplifier. It has a typical bias current of 30nA flowing into the pin. The ADJ pin reference voltage is 1.25V referenced to ground. The output voltage range is 1.25V to 6V and is typically set by connecting ADJ to a resistor divider from OUT to GND. See Figure 2.

BYP (Pin 4, Fixed/Pin 3, BYP Devices): Noise Bypass. The BYP pin is used to augment the internal noise filter to improve low noise performance. A small low leakage bypass capacitor from this pin to ground will filter the input of the error amplifier to lower the output voltage noise. Any value may be used; larger values will result in lower output noise, but will increase initial power-up time. Shutdown exit delay time after a brief shutdown ($<10\text{ms}$) will not be affected. If not used, this pin must be left unconnected.

OUT (Pin 5): Voltage Regulated Output. The OUT pin supplies power to the load. A minimum output capacitor of $1\mu\text{F}$ is required to ensure stability. Larger output capacitors may be required for applications with large transient loads to limit peak voltage transients. See the Applications Information section for more information on output capacitance.

APPLICATIONS INFORMATION

The LTC1844 family are a series of 150mA ultralow dropout regulators with micropower quiescent current and shutdown. The devices are capable of supplying 150mA at a dropout voltage of 90mV (LTC1844-3.3, see Electrical Characteristics for dropout voltage of other versions). Output voltage noise is as low as $30\mu V_{RMS}$ over a 10Hz to 100kHz bandwidth with the addition of a $0.1\mu F$ bypass capacitor. The low operating quiescent current ($35\mu A$) drops to 10nA in shutdown.

In addition to the low quiescent current, the LTC1844 regulators incorporate several protection features which make them ideal for use in battery-powered systems. The devices are protected against both reverse input voltages and reverse voltages from output to input (reverse current protection). The devices also include current limit and thermal overload protection, and will survive an output short circuit indefinitely. The fast transient response overcomes the traditional tradeoff between dropout voltage, quiescent current and load transient response inherent in most regulators by using a proprietary new architecture (see Figure 1).

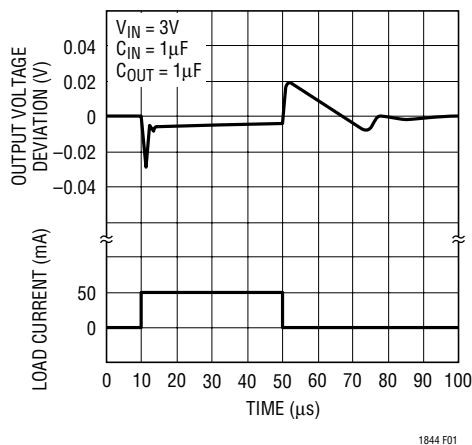

Figure 1. LTC1844-2.5 Transient Response 1mA to 50mA to 1mA

Adjustable Operation

The adjustable version of the LTC1844 has an output voltage range of 1.25V to 6V. The output voltage is set by the ratio of two external resistors as shown in Figure 2. The device servos the output to maintain the ADJ pin voltage at 1.25V (referenced to ground). The current in R1 is then equal to $1.25V/R1$ and the current in R2 is the current in R1 plus the ADJ pin bias current. The ADJ pin bias current, 30nA at 25°C, flows through R2 into the ADJ pin. The output voltage can be calculated using the formula in Figure 2. The value of R1 should be no greater than $1M\Omega$ to minimize errors in the output voltage caused by the ADJ pin bias current. Note that in shutdown the output is turned off and the divider current will be zero once C_{OUT} is discharged.

Adjustable devices are tested and specified with the ADJ pin tied to the OUT pin for an output voltage of 1.25V. Specifications for output voltages greater than 1.25V will be proportional to the ratio of the desired output voltage to 1.25V: $V_{OUT}/1.25V$. For example, load regulation for an

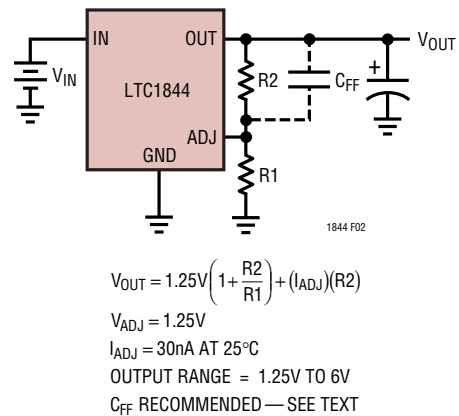

Figure 2. Adjustable Operation

APPLICATIONS INFORMATION

output current change of 1mA to 100mA is -4mV typical at $V_{\text{OUT}} = 1.25\text{V}$. At $V_{\text{OUT}} = 5\text{V}$, load regulation is:

$$(5\text{V}/1.25\text{V})(-4\text{mV}) = -16\text{mV}$$

Because the ADJ pin is relatively high impedance (depending on the resistor divider used), stray capacitance at this pin can introduce significant phase shift in the error amplifier loop. The PCB layout should be designed to absolutely minimize the capacitance seen at the ADJ pin. To ensure stability over all operating conditions when utilizing large divider resistors, a small feedforward capacitor ($\approx 1000\text{pF}$) in parallel with the upper divider resistor (C_{FF} in Figure 2) is recommended. As an added bonus, this capacitor will improve transient response.

Bypass Capacitance and Low Noise Performance

A bypass capacitor can optionally be connected from the BYP pin to ground to lower output voltage noise. A good quality low leakage capacitor is recommended. This capacitor will bypass the input of the error amplifier, providing a low frequency noise pole. The noise pole provided by this bypass capacitor will lower the output voltage noise to as low as $30\mu\text{V}_{\text{RMS}}$ with the addition of a $0.1\mu\text{F}$ capacitor.

Initial regulator power-up time is inversely proportional to the size of the bypass capacitor, slowing to 10ms with a $0.1\mu\text{F}$ bypass capacitor and $10\mu\text{F}$ output capacitor. However, the LTC1844 does not discharge the bypass capacitor when put into shutdown and thus the shutdown exit

delay can be much shorter ($\approx 70\mu\text{s}$) than initial power-up time if the shutdown duration is brief ($< 10\text{ms}$). The maximum shutdown duration required to allow fast shutdown exit is determined by the capacitor leakage current, thus a low leakage bypass capacitor is recommended.

Output Capacitance and Transient Response

The LTC1844 regulators are designed to be stable with a wide range of output capacitors. The ESR of the output capacitor affects stability, most notably with small capacitors. A minimum output capacitor of $1\mu\text{F}$ with an ESR of 0.3Ω or less is recommended to ensure stability. The LTC1844 is a micropower device and output transient response will be a function of output capacitance. Larger values of output capacitance decrease the peak deviations and provide improved transient response for larger load current changes. Note that bypass capacitors used to decouple individual components powered by the LTC1844 will increase the effective output capacitor value. The shaded region of Figure 3 defines the region over which the LTC1844 regulators are stable. The maximum ESR allowed is 0.3Ω . High ESR tantalum and electrolytic capacitors may be used, but a low ESR ceramic capacitor must be in parallel at the output. There is no minimum ESR requirement.

Extra consideration must be given to the use of ceramic capacitors. Ceramic capacitors are manufactured with a variety of dielectrics, each with different behavior across

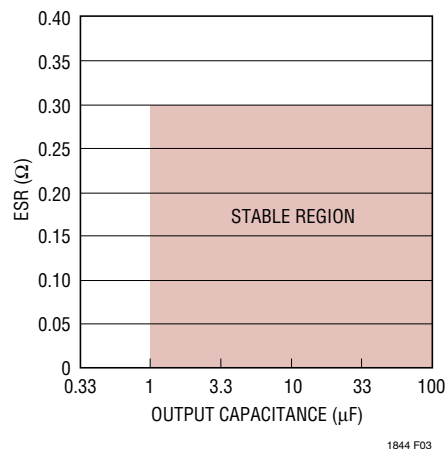

Figure 3. Stability

APPLICATIONS INFORMATION

temperature and applied voltage. The most common dielectrics used are Z5U, Y5V, X5R and X7R. The Z5U and Y5V dielectrics are good for providing high capacitances in a small package, but exhibit strong voltage and temperature coefficients as shown in Figures 4 and 5. When used with a 5V regulator, a 10 μ F Y5V capacitor can exhibit an effective value as low as 1 μ F to 2 μ F over the operating temperature range. The X5R and X7R dielectrics result in more stable characteristics and are more suitable for use as the output capacitor. The X7R type has better stability across temperature, while the X5R is less expensive and is available in higher values.

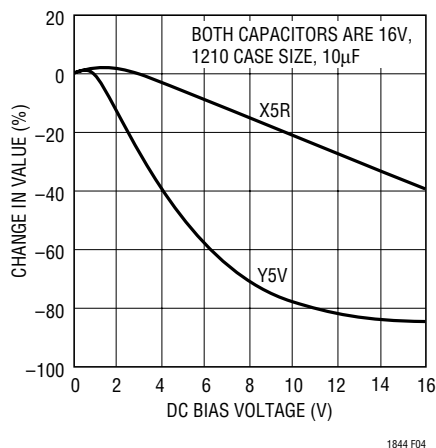

Figure 4. Ceramic Capacitor DC Bias Characteristics

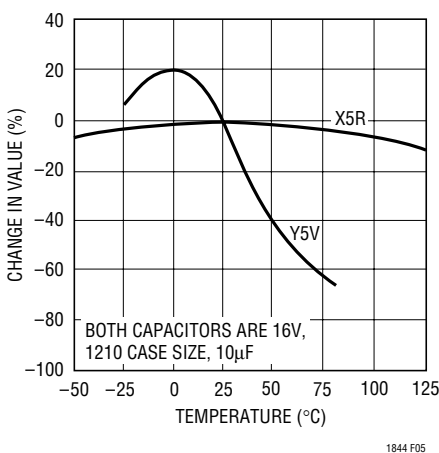

Figure 5. Ceramic Capacitor Temperature Characteristics

Additionally, some ceramic capacitors have a piezoelectric response. A piezoelectric device generates voltage across its terminals due to mechanical stress, similar to the way a piezoelectric accelerometer or microphone works. For a ceramic capacitor the stress can be induced by vibrations in the system or thermal transients. The resulting voltages produced can cause appreciable amounts of noise, especially when a ceramic capacitor is used for noise bypassing. A ceramic capacitor produced Figure 6's trace in response to light tapping from a pencil. Similar vibration-induced behavior can masquerade as increased output voltage noise.

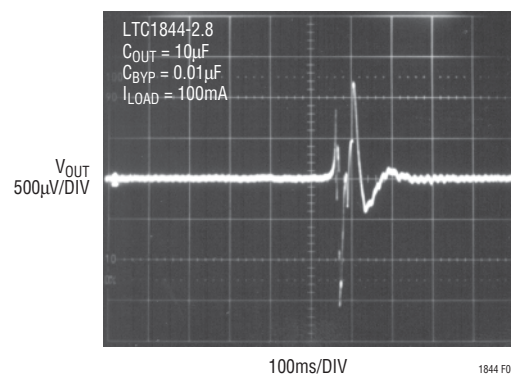

Figure 6. Noise Resulting from Tapping on a Ceramic Capacitor

Dropout Recovery and Output Overshoot

If the input supply voltage drops too low for the LTC1844 to maintain regulation, the internal feedback loop goes into dropout and the internal pass transistor turns fully on. If the input supply then suddenly rises, the output may briefly overshoot the intended output voltage while the LTC1844 transitions back from dropout to normal operation. This behavior occurs when the input supply slew rate is greater than 1V/ms and the output bypass capacitor is small. If the input is expected to slew rapidly, an output bypass capacitor of 10 μ F or greater should be used to minimize output overshoot. Note that overshoot typically does not occur at start-up since the feedback loop does not spend a significant amount of time in dropout.

APPLICATIONS INFORMATION

Thermal Considerations

The power handling capability of the device will be limited by the maximum rated junction temperature (125°C). The power dissipated by the device will be the output current multiplied by the input/output voltage differential: $(I_{OUT})(V_{IN} - V_{OUT})$.

The LTC1844 series regulators have internal thermal limiting designed to protect the device during momentary overload conditions. For continuous normal conditions, the maximum junction temperature rating of 125°C must not be exceeded. It is important to give careful consideration to all sources of thermal resistance from junction to ambient. Additional heat sources mounted nearby must also be considered.

For surface mount devices, heat sinking is accomplished by using the heat-spreading capabilities of the PC board and its copper traces. Copper board stiffeners and plated through holes can also be used to spread the heat generated by power devices.

Table 1 lists thermal resistance for several different board sizes and copper areas. All measurements were taken in still air on 3/32" FR-4 board with one ounce copper.

Table 1. Measured Thermal Resistance

| COPPER AREA | | BOARD AREA | THERMAL RESISTANCE (JUNCTION-TO-AMBIENT) |
|---------------------|---------------------|---------------------|---|
| TOPSIDE* | BACKSIDE | | |
| 2500mm ² | 2500mm ² | 2500mm ² | 125°C/W |
| 1000mm ² | 2500mm ² | 2500mm ² | 125°C/W |
| 225mm ² | 2500mm ² | 2500mm ² | 130°C/W |
| 100mm ² | 2500mm ² | 2500mm ² | 135°C/W |
| 50mm ² | 2500mm ² | 2500mm ² | 150°C/W |

*Device is mounted on topside.

Calculating Junction Temperature

Example: Given an output voltage of 3.3V, an input voltage of 4V to 6V, an output current range of 0mA to 50mA and a maximum ambient temperature of 50°C, what will the maximum junction temperature be?

The power dissipated by the device will be equal to:

$$I_{OUT(MAX)}(V_{IN(MAX)} - V_{OUT})$$

where:

$$I_{OUT(MAX)} = 50\text{mA}$$

$$V_{IN(MAX)} = 6\text{V}$$

So:

$$P = 50\text{mA}(6\text{V} - 3.3\text{V}) = 0.135\text{W}$$

The power dissipated by the LTC1844's quiescent current (240μW) is insignificant. The thermal resistance will be in the range of 125°C/W to 150°C/W depending on the copper area. The junction temperature rise above ambient will be approximately equal to:

$$0.135\text{W}(150^\circ\text{C/W}) = 20.3^\circ\text{C}$$

The maximum junction temperature will then be equal to the maximum junction temperature rise above ambient plus the maximum ambient temperature or:

$$T = 50^\circ\text{C} + 20.3^\circ\text{C} = 70.3^\circ\text{C}$$

Protection Features

The LTC1844 regulators incorporate several protection features which make them ideal for use in battery-powered circuits. In addition to the usual protection features associated with monolithic regulators, such as current limiting and thermal limiting, the devices are protected against reverse input voltages and reverse voltages from output to input.

Current limit protection and thermal overload protection are intended to protect the device against current overload conditions at the output of the device. For normal operation, the junction temperature should not exceed 125°C.

The input of the device will withstand input voltages of -7V. Current flow into the device will be limited to less than 500μA (typically less than 200μA) and only a small negative voltage will appear at the output (~-300mV with no load). The LTC1844 will protect both itself and the load against batteries plugged in backward. The shutdown pin will require current limiting if used (see Pin Functions).

APPLICATIONS INFORMATION

In circuits where a backup battery is required, several different input/output conditions can occur. The output voltage may be held up externally while the input is either pulled to ground, pulled to some intermediate voltage or left open circuit. The LTC1844 features reverse current protection to limit current draw from any supplementary power source at the output. When V_{IN} is pulled to ground or is left open circuit, I_{IN} and I_{OUT} are less than $0.1\mu\text{A}$ for $V_{OUT} = 0\text{V}$ to 7V .

When V_{IN} is held constant and V_{OUT} varied, current flow will follow the curves shown in Figure 7. With V_{OUT} held below $V_{OUT(NOM)}$, the LTC1844 will be in current limit

trying to pull V_{OUT} up. With V_{OUT} held between $V_{OUT(NOM)}$ and V_{IN} , I_{IN} will be at the normal quiescent current level and I_{OUT} will be $1\mu\text{A}$ to $2\mu\text{A}$. As V_{OUT} is pulled above V_{IN} , I_{OUT} temporarily increases to $30\mu\text{A}$ until the reverse current protection circuitry activates and reduces I_{OUT} to less than $10\mu\text{A}$.

Alternatively, when V_{OUT} is held constant and V_{IN} varied, current flow will follow Figure 8's curves. I_{OUT} will be less than $10\mu\text{A}$ at all times except for a brief spike just below 2.7V before the reverse current protection circuitry activates.

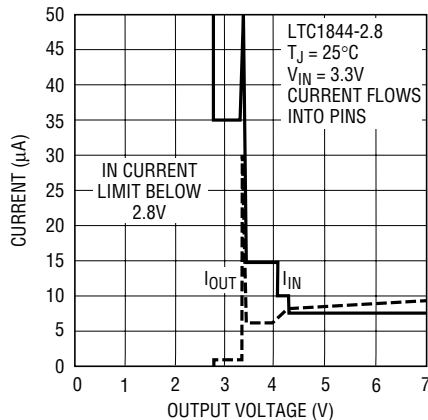

1844 F07

Figure 7. Reverse Current vs Output Voltage

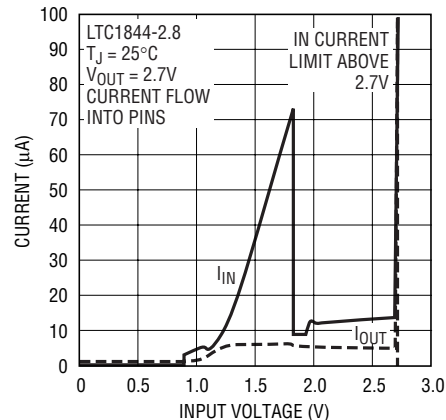

1844 F08

Figure 8. Reverse Current vs Input Voltage

PACKAGE DESCRIPTION

S5 Package
5-Lead Plastic TSOT-23
 (Reference LTC DWG # 05-08-1635)

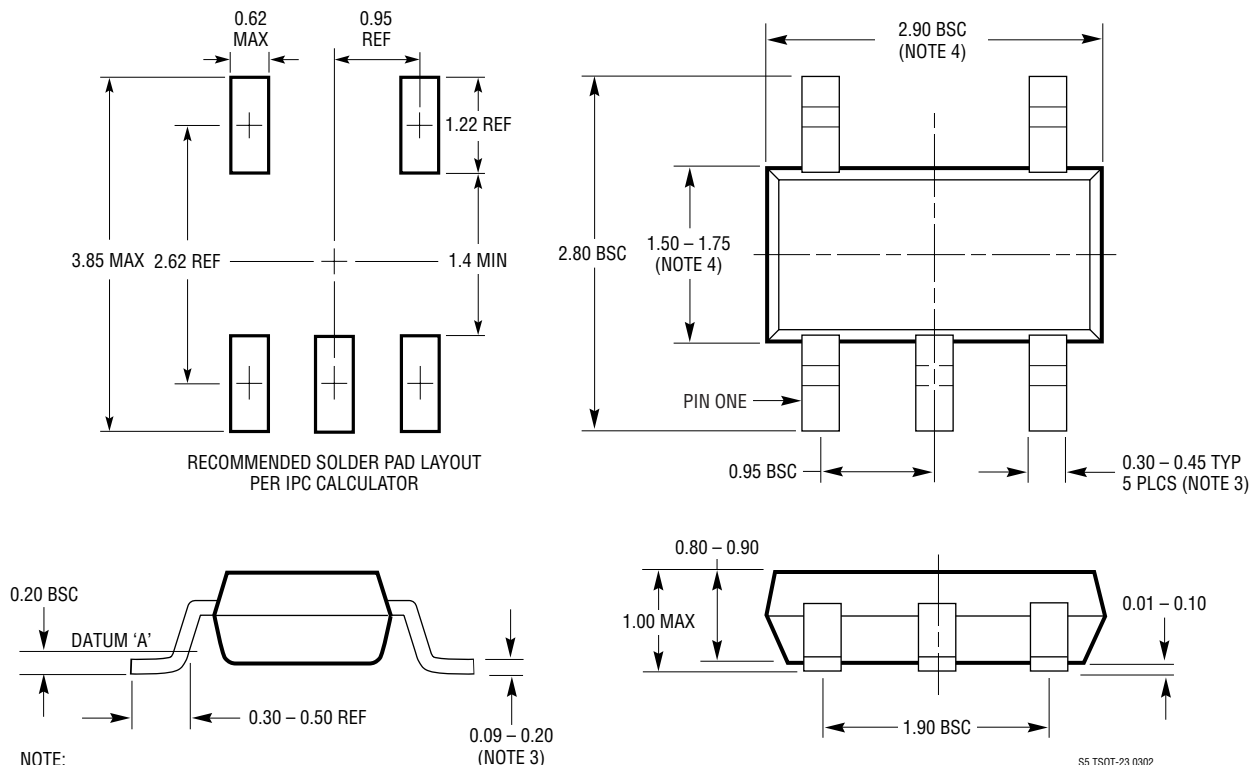

- NOTE:
1. DIMENSIONS ARE IN MILLIMETERS
 2. DRAWING NOT TO SCALE
 3. DIMENSIONS ARE INCLUSIVE OF PLATING
 4. DIMENSIONS ARE EXCLUSIVE OF MOLD FLASH AND METAL BURR
 5. MOLD FLASH SHALL NOT EXCEED 0.254mm
 6. JEDEC PACKAGE REFERENCE IS MO-193

RELATED PARTS

| PART NUMBER | DESCRIPTION | COMMENTS |
|-------------|--|---|
| LT1761 | 100mA, Low Noise LDO in ThinSOT | 300mV Dropout Voltage, Low Noise: $20\mu V_{RMS}$, $V_{IN} = 1.8V$ to 20V, ThinSOT |
| LT1762 | 150mA, Low Noise LDO | 300mV Dropout Voltage, Low Noise: $20\mu V_{RMS}$, $V_{IN} = 1.8V$ to 20V, MS8 Package |
| LT1763 | 500mA, Low Noise LDO | 300mV Dropout Voltage, Low Noise: $20\mu V_{RMS}$, $V_{IN} = 1.8V$ to 20V, SO-8 Package |
| LT1764A | 3A, Fast Transient Response, Low Noise LDO | 340mV Dropout Voltage, Low Noise: $40\mu V_{RMS}$, $V_{IN} = 2.7V$ to 20V, TO-220 and DD Packages |
| LT1962 | 300mA, Low Noise LDO | 270mV Dropout Voltage, Low Noise: $20\mu V_{RMS}$, $V_{IN} = 1.8V$ to 20V, MS8 Package |
| LT1963A | 1.5A Low Noise, Fast Transient Response LDO | 340mV Dropout Voltage, Low Noise: $40\mu V_{RMS}$, $V_{IN} = 2.5V$ to 20V, TO-220, DD, SOT-223 and SO-8 Packages |
| LT1964 | 200mA, Low Noise, Negative LDO | 340mV Dropout Voltage, Low Noise $30\mu V_{RMS}$, $V_{IN} = -1.8V$ to -20V, ThinSOT |
| LT3150 | Fast Transient Response, VLDO Regulator Controller | 0.035mV Dropout Voltage via External FET, V_{IN} : 1.3V to 10V |

1844fa

X-ON Electronics

Largest Supplier of Electrical and Electronic Components

Click to view similar products for [LDO Voltage Regulators](#) category:

Click to view products by [Analog Devices](#) manufacturer:

Other Similar products are found below :

[M38D29FFHP#U1](#) [702103A](#) [717726C](#) [742457H](#) [MP20051DN-LF-Z](#) [R5F111PGGFB#30](#) [AP7363-SP-13](#) [NCP103AMX285TCG](#)
[NCV8664CST33T3G](#) [NCV8752AMX28TCG](#) [L9454](#) [AP7362-HA-7](#) [LX13043CLD](#) [TCR3DF185,LM\(CT](#) [TCR3DF24,LM\(CT](#)
[TCR3DF285,LM\(CT](#) [TCR3DF31,LM\(CT](#) [TCR3DF45,LM\(CT](#) [TLF4949EJ](#) [MP2013GQ-33-Z](#) [L9708](#) [L970813TR](#) [030014BB](#) [059985X](#)
[NCP121AMX173TCG](#) [NCP4687DH15T1G](#) [NCV8703MX30TCG](#) [701326R](#) [702087BB](#) [755078E](#) [TCR2EN28,LF\(S](#) [LM1117DT-1.8/NO](#)
[LT1086CM#TRPBF](#) [AZ1085S2-1.5TRE1](#) [MAX15101EWL+T](#) [NCV8170AXV250T2G](#) [SCD337BTG](#) [TCR3DF27,LM\(CT](#)
[TCR3DF19,LM\(CT](#) [TCR3DF125,LM\(CT](#) [MAX15103EWL+T](#) [TS2937CZ-5.0 C0](#) [MAX8878EUK30-T](#) [MAX663CPA](#) [NCV4269CPD50R2G](#)
[NCV8716MT30TBG](#) [AZ1117IH-1.2TRG1](#) [MP2013GQ-P](#) [AP2112R5A-3.3TRG1](#) [AP7315-25W5-7](#)