



TISP4070M3AJ THRU TISP4115M3AJ,
TISP4125M3AJ THRU TISP4220M3AJ,
TISP4240M3AJ THRU TISP4395M3AJ

BIDIRECTIONAL THYRISTOR OVERVOLTAGE PROTECTORS

TISP4xxxM3AJ Overvoltage Protector Series

4 kV 10/700, 100 A 5/310 ITU-T K.20/21 rating

SMA (DO-214AC) Package

25% Smaller Placement Area than SMB

Low Differential Capacitance 39 pF

Ion-Implanted Breakdown Region

Precise and Stable Voltage

Low Voltage Overshoot under Surge

Device	V _{DRM} V	V _(BO) V
'4070	58	70
'4080	65	80
'4090	68	90
'4095	75	95
'4115	90	115
'4125	100	125
'4145	120	145
'4165	135	165
'4180	145	180
'4200	155	200
'4220	160	220
'4240	180	240
'4250	190	250
'4265	200	265
'4290	220	290
'4300	230	300
'4320	240	320
'4350	275	350
'4360	290	360
'4395	320	395

SMAJ Package (Top View)



MDXXCCE

Device Symbol



Terminals T and R correspond to the alternative line designators of A and B

Rated for International Surge Wave Shapes

Wave Shape	Standard	I _{TSP} A
2/10 μs	GR-1089-CORE	300
8/20 μs	IEC 61000-4-5	220
10/160 μs	FCC Part 68	120
10/700 μs	ITU-T K.20/21/45	100
10/560 μs	FCC Part 68	75
10/1000 μs	GR-1089-CORE	50

..... UL Recognized Components

How To Order

Device	Package	Carrier	Order As
TISP4xxxM3AJ	AJ (J-Bend DO-214AC/SMA)	Embossed Tape Reeled	TISP4xxxM3AJR-S

Insert xxx value corresponding to protection voltages of 070, 080, 095, etc.

Description

These devices are designed to limit overvoltages on the telephone line. Overvoltages are normally caused by a.c. power system or lightning flash disturbances which are induced or conducted on to the telephone line. A single device provides 2-point protection and is typically used for the protection of 2-wire telecommunication equipment (e.g. between the Ring and Tip wires for telephones and modems). Combinations of devices can be used for multi-point protection (e.g. 3-point protection between Ring, Tip and Ground).

The protector consists of a symmetrical voltage-triggered bidirectional thyristor. Overvoltages are initially clipped by breakdown clamping until the voltage rises to the breakover level, which causes the device to crowbar into a low-voltage on state. This low-voltage on state causes the current resulting from the overvoltage to be safely diverted through the device. The high crowbar holding current helps prevent d.c. latchup as the diverted current subsides.

*RoHS Directive 2002/95/EC Jan 27 2003 including Annex
AUGUST 2001 - REVISED JANUARY 2007
Specifications are subject to change without notice.
Customers should verify actual device performance in their specific applications.

TISP4xxxM3AJ Overvoltage Protector Series

BOURNS®

Description (continued)

The TISP4xxxM3AJ range consists of twenty voltage variants to meet various maximum system voltage levels (58 V to 320 V). They are guaranteed to voltage limit and withstand the listed international lightning surges in both polarities. These medium (M) current protection devices are in a plastic package SMAJ (JEDEC DO-214AC with J-bend leads) and supplied in embossed tape reel pack. For alternative voltage and holding current values, consult the factory. For higher rated impulse currents, the 100 A 10/1000 TISP4xxxH3BJ series in the SMB (JEDEC DO-214AA) package is available.

Absolute Maximum Ratings, $T_A = 25\text{ }^\circ\text{C}$ (Unless Otherwise Noted)

Rating	Symbol	Value	Unit
Repetitive peak off-state voltage, (see Note 1)	'4070	± 58	V
	'4080	± 65	
	'4090	± 68	
	'4095	± 75	
	'4115	± 90	
	'4125	±100	
	'4145	±120	
	'4165	±135	
	'4180	±145	
	'4200	±155	
	'4220	V_{DRM} ±160	
	'4240	±180	
	'4250	±190	
	'4265	±200	
	'4290	±220	
	'4300	±230	
	'4320	±240	
	'4350	±275	
	'4360	±290	
	'4395	±320	
Non-repetitive peak on-state pulse current (see Notes 2, 3 and 4)	I_{TSP}	300	A
2/10 μs (GR-1089-CORE, 2/10 μs voltage wave shape)		220	
8/20 μs (IEC 61000-4-5, combination wave generator, 1.2/50 voltage, 8/20 current)		120	
10/160 μs (FCC Part 68, 10/160 μs voltage wave shape)		110	
5/200 μs (VDE 0433, 10/700 μs voltage wave shape)		100	
0.2/310 μs (I3124, 0.5/700 μs voltage wave shape)		100	
5/310 μs (ITU-T K.20/21/45, K.44 10/700 μs voltage wave shape)		100	
5/310 μs (FTZ R12, 10/700 μs voltage wave shape)		75	
10/560 μs (FCC Part 68, 10/560 μs voltage wave shape)		50	
10/1000 μs (GR-1089-CORE, 10/1000 μs voltage wave shape)			
Non-repetitive peak on-state current (see Notes 2, 3 and 5)	I_{TSM}	23	A
20 ms (50 Hz) full sine wave		24	
16.7 ms (60 Hz) full sine wave		1.6	
1000 s 50 Hz/60 Hz a.c.			
Initial rate of rise of on-state current, Exponential current ramp, Maximum ramp value < 100 A	di_T/dt	300	A/ μs
Junction temperature	T_J	-40 to +150	$^\circ\text{C}$
Storage temperature range	T_{stg}	-65 to +150	$^\circ\text{C}$

- NOTES: 1. See Applications Information and Figure 10 for voltage values at lower temperatures.
 2. Initially, the TISP4xxxM3AJ must be in thermal equilibrium with $T_J = 25\text{ }^\circ\text{C}$.
 3. The surge may be repeated after the TISP4xxxM3AJ returns to its initial conditions.
 4. See Applications Information and Figure 11 for current ratings at other temperatures.
 5. EIA/JESD51-2 environment and EIA/JESD51-3 PCB with standard footprint dimensions connected with 5 A rated printed wiring track widths. See Figure 9 for the current ratings at other durations. Derate current values at $-0.61\text{ }^\circ\text{C}$ for ambient temperatures above $25\text{ }^\circ\text{C}$.

TISP4xxxM3AJ Overvoltage Protector Series

BOURNS®

Electrical Characteristics, $T_A = 25\text{ }^\circ\text{C}$ (Unless Otherwise Noted)

Parameter	Test Conditions	Min	Typ	Max	Unit
I_{DRM} Repetitive peak off-state current	$V_D = V_{\text{DRM}}$ $T_A = 25\text{ }^\circ\text{C}$ $T_A = 85\text{ }^\circ\text{C}$			± 5 ± 10	μA
$V_{(\text{BO})}$ Breakover voltage	$dv/dt = \pm 250\text{ V/ms}$, $R_{\text{SOURCE}} = 300\ \Omega$			'4070 ± 70 '4080 ± 80 '4090 ± 90 '4095 ± 95 '4115 ± 115 '4125 ± 125 '4145 ± 145 '4165 ± 165 '4180 ± 180 '4200 ± 200 '4220 ± 220 '4240 ± 240 '4250 ± 250 '4265 ± 265 '4290 ± 290 '4300 ± 300 '4320 ± 320 '4350 ± 350 '4360 ± 360 '4395 ± 395	V
$V_{(\text{BO})}$ Impulse breakover voltage	$dv/dt \leq \pm 1000\text{ V}/\mu\text{s}$, Linear voltage ramp, Maximum ramp value = $\pm 500\text{ V}$ $di/dt = \pm 20\text{ A}/\mu\text{s}$, Linear current ramp, Maximum ramp value = $\pm 10\text{ A}$			'4070 ± 78 '4080 ± 88 '4090 ± 98 '4095 ± 102 '4115 ± 122 '4125 ± 132 '4145 ± 151 '4165 ± 171 '4180 ± 186 '4200 ± 207 '4220 ± 227 '4240 ± 247 '4250 ± 257 '4265 ± 272 '4290 ± 298 '4300 ± 308 '4320 ± 328 '4350 ± 359 '4360 ± 370 '4395 ± 405	V
$I_{(\text{BO})}$ Breakover current	$dv/dt = \pm 250\text{ V/ms}$, $R_{\text{SOURCE}} = 300\ \Omega$	± 0.15		± 0.6	A
V_T On-state voltage	$I_T = \pm 5\text{ A}$, $t_W = 100\ \mu\text{s}$			± 3	V
I_H Holding current	$I_T = \pm 5\text{ A}$, $di/dt = +/- 30\text{ mA/ms}$	± 0.15		± 0.35	A
dv/dt Critical rate of rise of off-state voltage	Linear voltage ramp, Maximum ramp value $< 0.85V_{\text{DRM}}$	± 5			$\text{kV}/\mu\text{s}$

AUGUST 2001 - REVISED JANUARY 2007

Specifications are subject to change without notice.

Customers should verify actual device performance in their specific applications.

TISP4xxxM3AJ Overvoltage Protector Series

BOURNS®

Electrical Characteristics, $T_A = 25\text{ }^\circ\text{C}$ (Unless Otherwise Noted)

Parameter	Test Conditions	Min	Typ	Max	Unit
I_D Off-state current	$V_D = \pm 50\text{ V}$ $T_A = 85\text{ }^\circ\text{C}$			± 10	μA
C_{off} Off-state capacitance	$f = 1\text{ MHz}$, $V_d = 1\text{ V rms}$, $V_D = 0$,	4070 thru '4115	83	100	pF
		'4125 thru '4220	62	74	
		'4240 thru '4400	50	60	
	$f = 1\text{ MHz}$, $V_d = 1\text{ V rms}$, $V_D = -1\text{ V}$	'4070 thru '4115	78	94	
		'4125 thru '4220	56	67	
		'4240 thru '4395	45	54	
	$f = 1\text{ MHz}$, $V_d = 1\text{ V rms}$, $V_D = -2\text{ V}$	'4070 thru '4115	72	87	
		'4125 thru '4220	52	62	
		'4240 thru '4395	42	50	
	$f = 1\text{ MHz}$, $V_d = 1\text{ V rms}$, $V_D = -50\text{ V}$	'4070 thru '4115	36	44	
		'4125 thru '4220	26	31	
		'4240 thru '4400	19	22	
$f = 1\text{ MHz}$, $V_d = 1\text{ V rms}$, $V_D = -100\text{ V}$ (see Note 6)	'4125 thru '4220	21	25		
	'4240 thru '4395	15	18		

NOTE 6: To avoid possible voltage clipping, the '4125 is tested with $V_D = -98\text{ V}$.

Thermal Characteristics

Parameter	Test Conditions	Min	Typ	Max	Unit
$R_{\theta JA}$ Junction to free air thermal resistance	EIA/JESD51-3 PCB, $I_T = I_{TSM(1000)}$, $T_A = 25\text{ }^\circ\text{C}$, (see Note 7)			115	$^\circ\text{C/W}$
	265 mm x 210 mm populated line card, 4-layer PCB, $I_T = I_{TSM(1000)}$, $T_A = 25\text{ }^\circ\text{C}$		52		

NOTE 7: EIA/JESD51-2 environment and PCB has standard footprint dimensions connected with 5 A rated printed wiring track widths.

Parameter Measurement Information

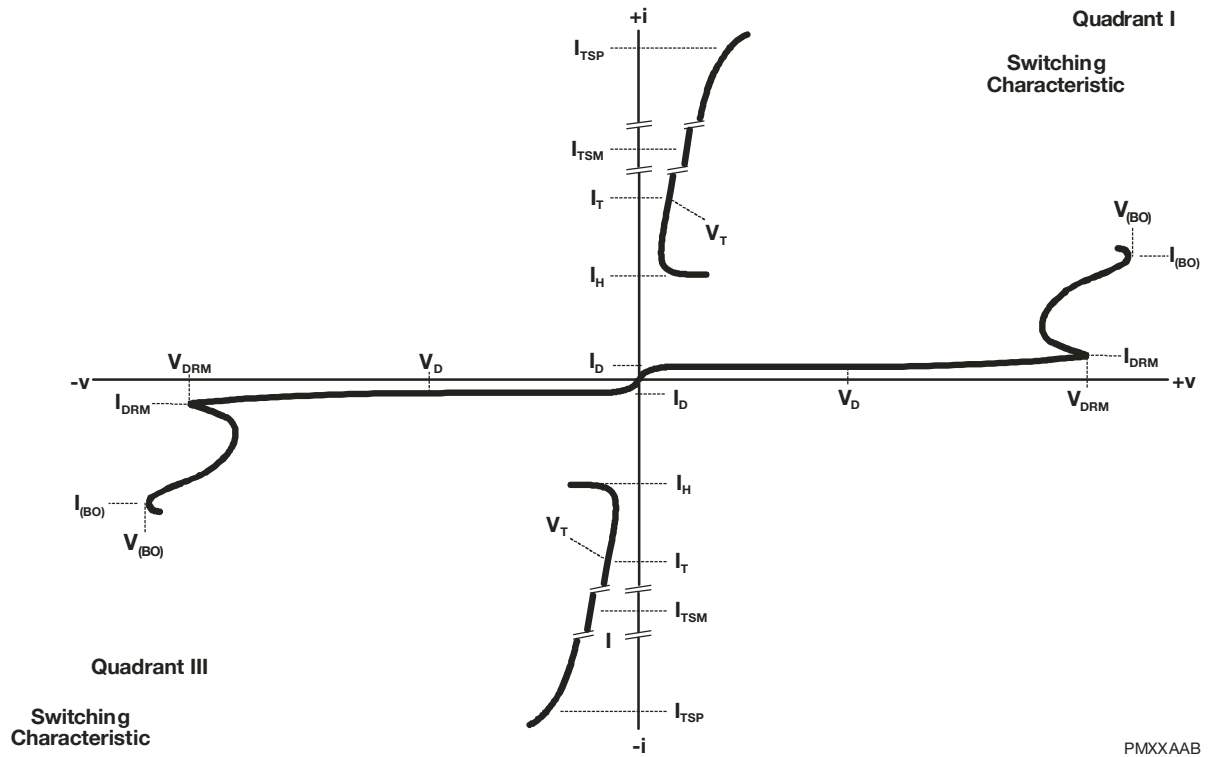

Figure 1. Voltage-Current Characteristic for T and R Terminals
All Measurements are Referenced to the R Terminal

Typical Characteristics

**OFF-STATE CURRENT
vs
JUNCTION TEMPERATURE**

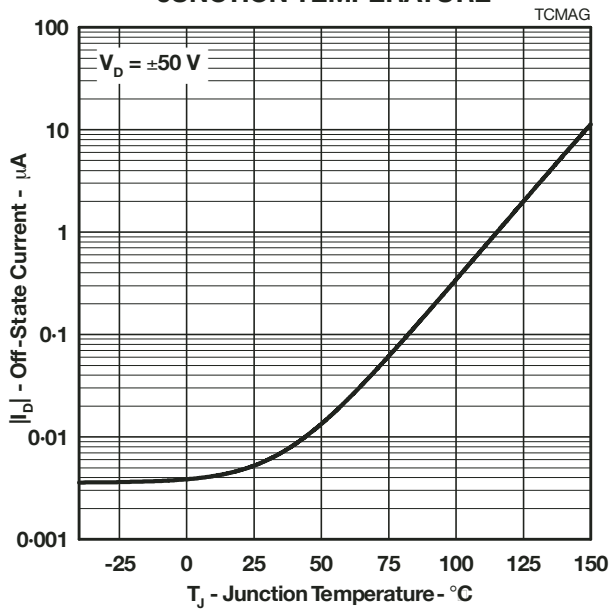

Figure 2.

**NORMALIZED BREAKOVER VOLTAGE
vs
JUNCTION TEMPERATURE**

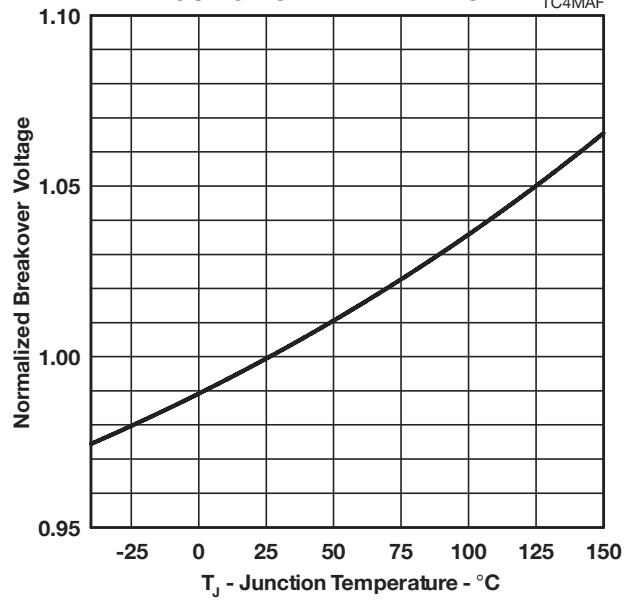

Figure 3.

**ON-STATE CURRENT
vs
ON-STATE VOLTAGE**

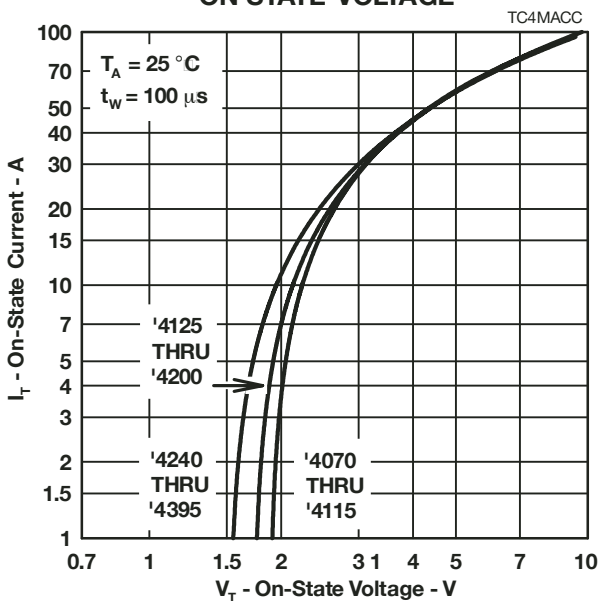

Figure 4.

**NORMALIZED HOLDING CURRENT
vs
JUNCTION TEMPERATURE**

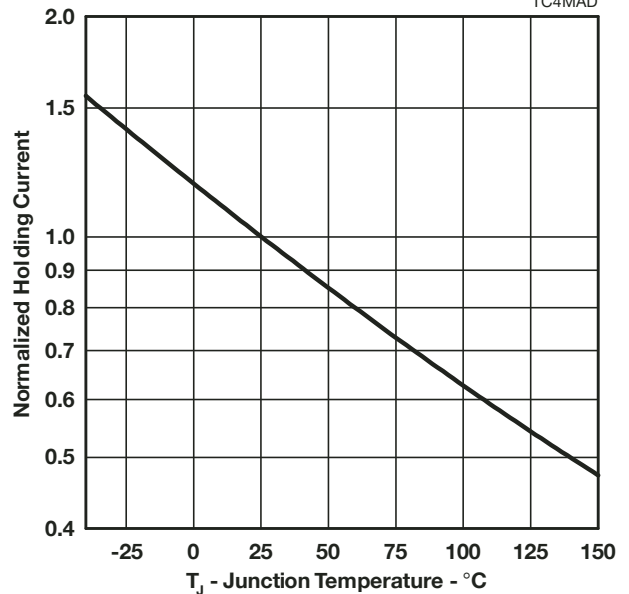
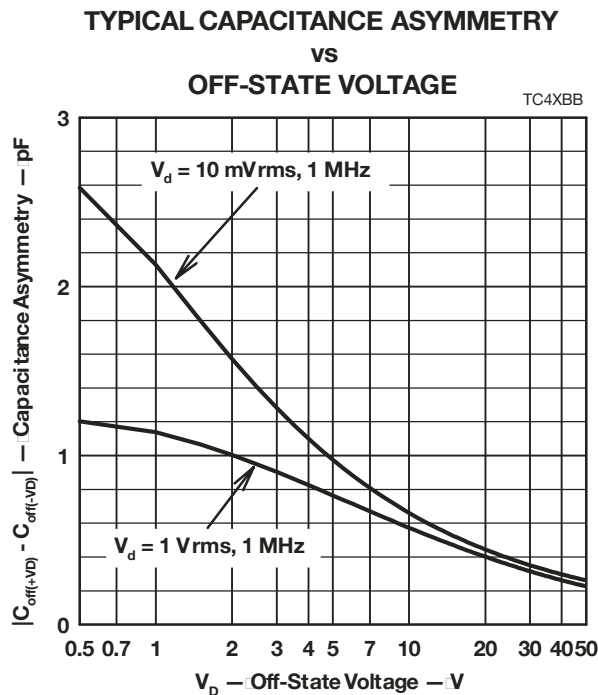
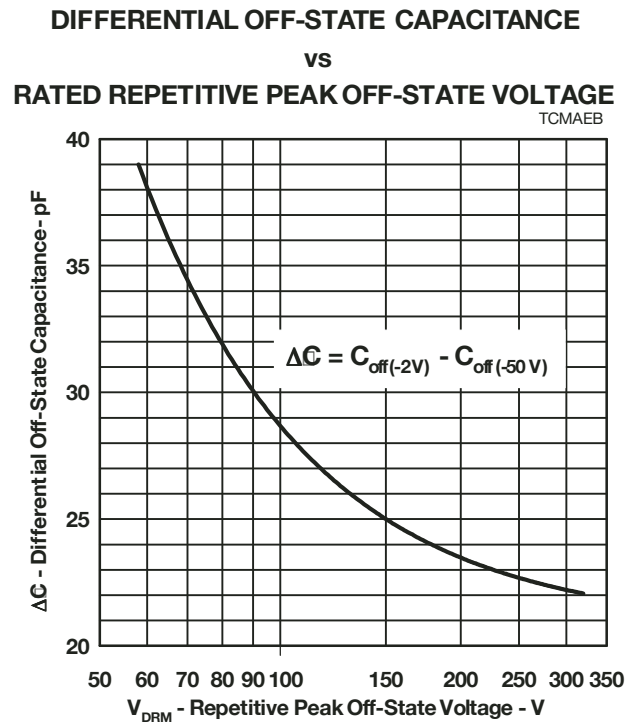
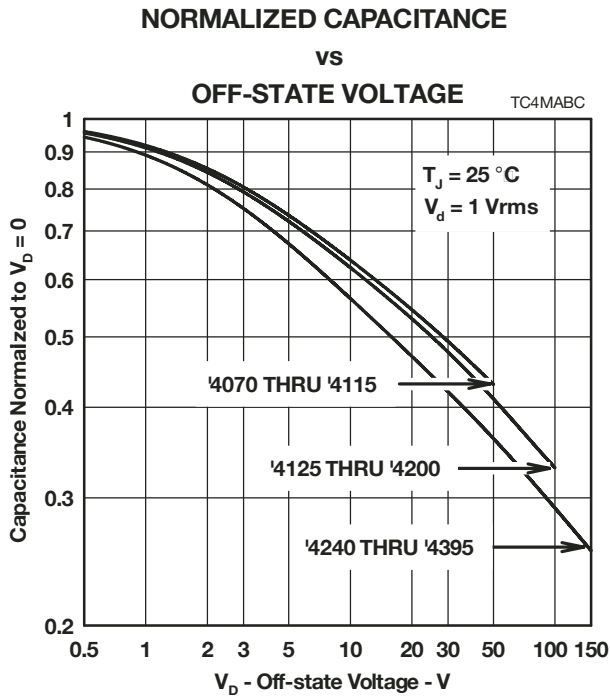

Figure 5.

Typical Characteristics



Rating and Thermal Information

NON-REPETITIVE PEAK ON-STATE CURRENT VS CURRENT DURATION

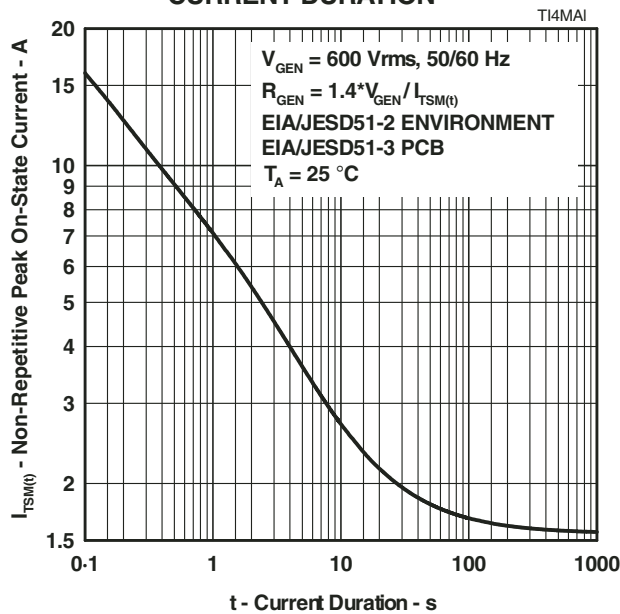

Figure 9.

V_{DRM} DERATING FACTOR

VS MINIMUM AMBIENT TEMPERATURE

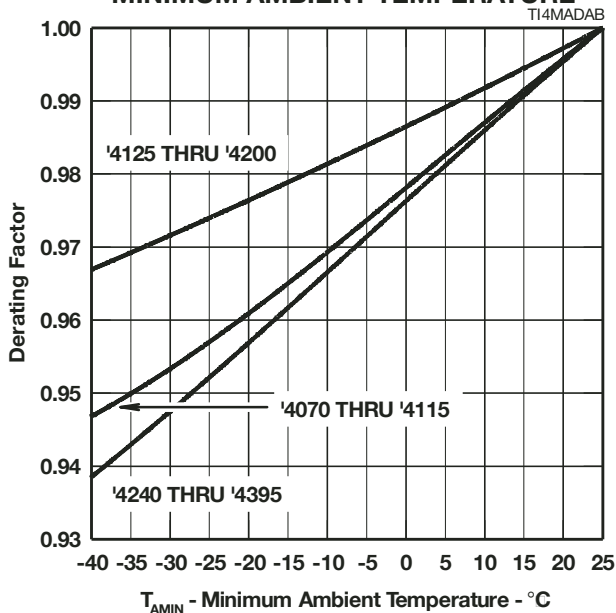

Figure 10.

IMPULSE RATING VS AMBIENT TEMPERATURE

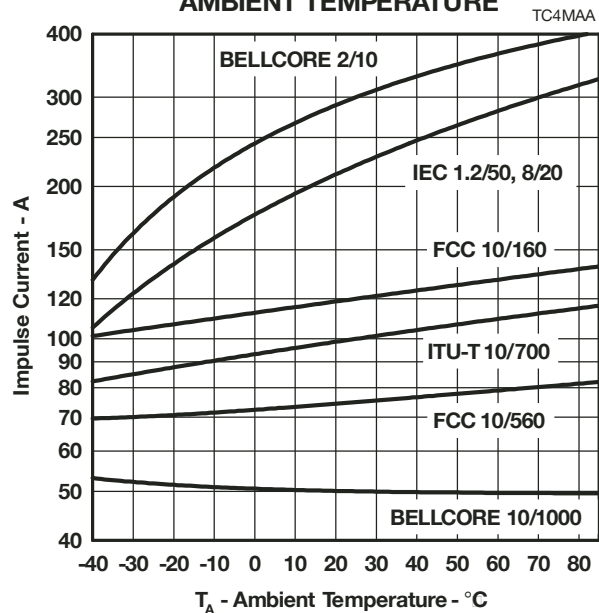

Figure 11.

APPLICATIONS INFORMATION

Deployment

These devices are two terminal overvoltage protectors. They may be used either singly to limit the voltage between two conductors (Figure 12) or in multiples to limit the voltage at several points in a circuit (Figure 13).

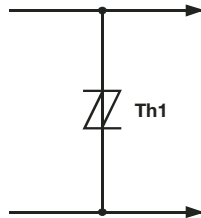

Figure 12. Two Point Protection

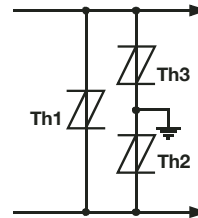

Figure 13. Multi-Point Protection

In Figure 12, protector Th1 limits the maximum voltage between the two conductors to $\pm V_{(BO)}$. This configuration is normally used to protect circuits without a ground reference, such as modems. In Figure 13, protectors Th2 and Th3 limit the maximum voltage between each conductor and ground to the $\pm V_{(BO)}$ of the individual protector. Protector Th1 limits the maximum voltage between the two conductors to its $\pm V_{(BO)}$ value. If the equipment being protected has all its vulnerable components connected between the conductors and ground, then protector Th1 is not required.

Impulse Testing

To verify the withstand capability and safety of the equipment, standards require that the equipment is tested with various impulse wave forms. The table below shows some common values.

Standard	Peak Voltage Setting V	Voltage Wave Shape μs	Peak Current Value A	Current Wave Shape μs	TISP4XXXM3 25 °C Rating A	Series Resistance Ω
GR-1089-CORE	2500	2/10	500	2/10	300	11
	1000	10/1000	100	10/1000	50	
FCC Part 68 (March 1998)	1500	10/160	200	10/160	120	2x5.6
	800	10/560	100	10/560	75	3
	1500	9/720 †	37.5	5/320 †	100	0
I3124	1000	9/720 †	25	5/320 †	100	0
	1500	0.5/700	37.5	0.2/310	100	0
ITU-T K.20/K.21	1500	10/700	37.5	5/310	100	0
	4000		100			

† FCC Part 68 terminology for the waveforms produced by the ITU-T recommendation K.21 10/700 impulse generator

If the impulse generator current exceeds the protector's current rating, then a series resistance can be used to reduce the current to the protector's rated value to prevent possible failure. The required value of series resistance for a given waveform is given by the following calculations. First, the minimum total circuit impedance is found by dividing the impulse generator's peak voltage by the protector's rated current. The impulse generator's fictive impedance (generator's peak voltage divided by peak short circuit current) is then subtracted from the minimum total circuit impedance to give the required value of series resistance.

For the FCC Part 68 10/560 waveform, the following values result. The minimum total circuit impedance is $800/75 = 10.7 \Omega$ and the generator's fictive impedance is $800/100 = 8 \Omega$. This gives a minimum series resistance value of $10.7 - 8 = 2.7 \Omega$. After allowing for tolerance, a $3 \Omega \pm 10\%$ resistor would be suitable. The 10/160 waveform needs a standard resistor value of 5.6Ω per conductor. These would be R1a and R1b in Figure 15 and Figure 16. FCC Part 68 allows the equipment to be non-operational after the 10/160 (conductor to ground) and 10/560 (inter-conductor) impulses. The series resistor value may be reduced to zero to pass FCC Part 68 in a non-operational mode, e.g. Figure 14. For this type of design, the series fuse must open before the TISP4xxxM3 fails. For Figure 14, the maximum fuse i^2t is $2.3 A^2s$. In some cases, the equipment will require verification over a temperature range. By using the rated waveform values from Figure 11, the appropriate series resistor value can be calculated for ambient temperatures in the range of $-40 \text{ }^\circ\text{C}$ to $85 \text{ }^\circ\text{C}$.

AC Power Testing

The protector can withstand currents applied for times not exceeding those shown in Figure 9. Currents that exceed these times must be terminated or reduced to avoid protector failure. Fuses, PTC (Positive Temperature Coefficient) thermistors and fusible resistors are overcurrent protection devices which can be used to reduce the current flow. Protective fuses may range from a few hundred milliamperes to one ampere. In some cases, it may be necessary to add some extra series resistance to prevent the fuse opening during impulse testing. The current versus time characteristic of the overcurrent protector must be below the line shown in Figure 9. In some cases, there may be a further time limit imposed by the test standard (e.g. UL 1459 wiring simulator failure).

Capacitance

The protector characteristic off-state capacitance values are given for d.c. bias voltage, V_D , values of 0, -1 V, -2 V and -50 V. Where possible values are also given for -100 V. Values for other voltages may be calculated by multiplying the $V_D = 0$ capacitance value by the factor given in Figure 6. Up to 10 MHz, the capacitance is essentially independent of frequency. Above 10 MHz, the effective capacitance is strongly dependent on connection inductance. In many applications, such as Figure 15 and Figure 17, the typical conductor bias voltages will be about -2 V and -50 V. Figure 7 shows the differential (line unbalance) capacitance caused by biasing one protector at -2 V and the other at -50 V.

Figure 8 shows the typical capacitance asymmetry; the difference between the capacitance measured with a positive value of V_D and the capacitance value when the polarity of V_D is reversed. Capacitance asymmetry is an important parameter in ADSL systems where the protector often has no d.c. bias and the signal level is in the region of ± 10 V.

Normal System Voltage Levels

The protector should not clip or limit the voltages that occur in normal system operation. For unusual conditions, such as ringing without the line connected, some degree of clipping is permissible. Under this condition, about 10 V of clipping is normally possible without activating the ring trip circuit.

Figure 10 allows the calculation of the protector V_{DRM} value at temperatures below 25 °C. The calculated value should not be less than the maximum normal system voltages. The TISP4265M3AJ, with a V_{DRM} of 200 V, can be used for the protection of ring generators producing 100 V rms of ring on a battery voltage of -58 V (Th2 and Th3 in Figure 17). The peak ring voltage will be $58 + 1.414 \times 100 = 199.4$ V. However, this is the open circuit voltage and the connection of the line and its equipment will reduce the peak voltage. In the extreme case of an unconnected line, clipping the peak voltage to 190 V should not activate the ring trip. This level of clipping would occur at the temperature when the V_{DRM} has reduced to $190/200 = 0.95$ of its 25 °C value. Figure 10 shows that this condition will occur at an ambient temperature of -28 °C. In this example, the TISP4265M3AJ will allow normal equipment operation provided that the minimum expected ambient temperature does not fall below -28 °C.

JESD51 Thermal Measurement Method

To standardize thermal measurements, the EIA (Electronic Industries Alliance) has created the JESD51 standard. Part 2 of the standard (JESD51-2, 1995) describes the test environment. This is a 0.0283 m³ (1 ft³) cube which contains the test PCB (Printed Circuit Board) horizontally mounted at the center. Part 3 of the standard (JESD51-3, 1996) defines two test PCBs for surface mount components; one for packages smaller than 27 mm on a side and the other for packages up to 48 mm. The SMBJ measurements used the smaller 76.2 mm x 114.3 mm (3.0 " x 4.5 ") PCB. The JESD51-3 PCBs are designed to have low effective thermal conductivity (high thermal resistance) and represent a worst case condition. The PCBs used in the majority of applications will achieve lower values of thermal resistance, and can dissipate higher power levels than indicated by the JESD51 values.

TISP4xxxM3AJ Overvoltage Protector Series

BOURNS®

Typical Circuits

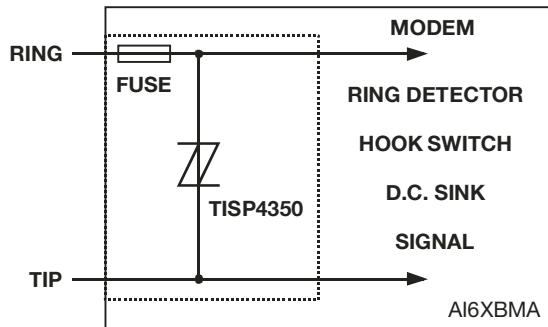

Figure 14. Modem Inter-Wire Protection

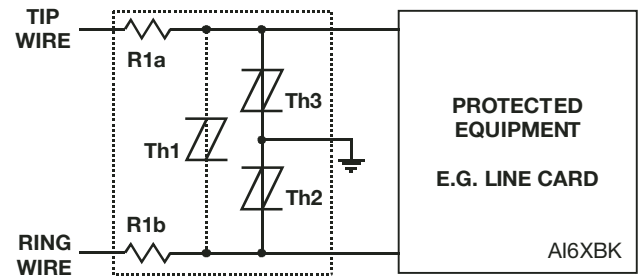

Figure 15. Protection Module

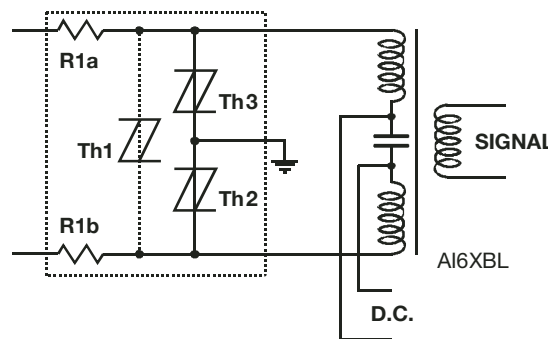

Figure 16. ISDN Protection

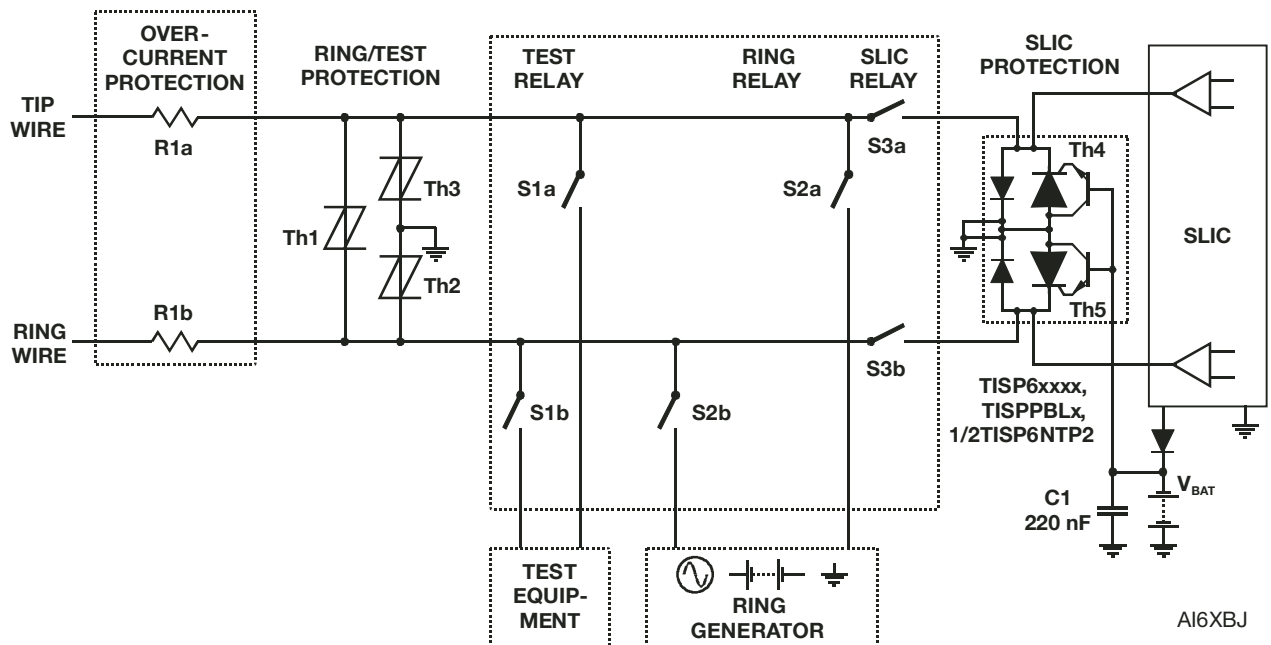

Figure 17. Line Card Ring/Test Protection

TISP4xxxM3AJ Overvoltage Protector Series

BOURNS®

MECHANICAL DATA

Recommended Printed Wiring Footprint

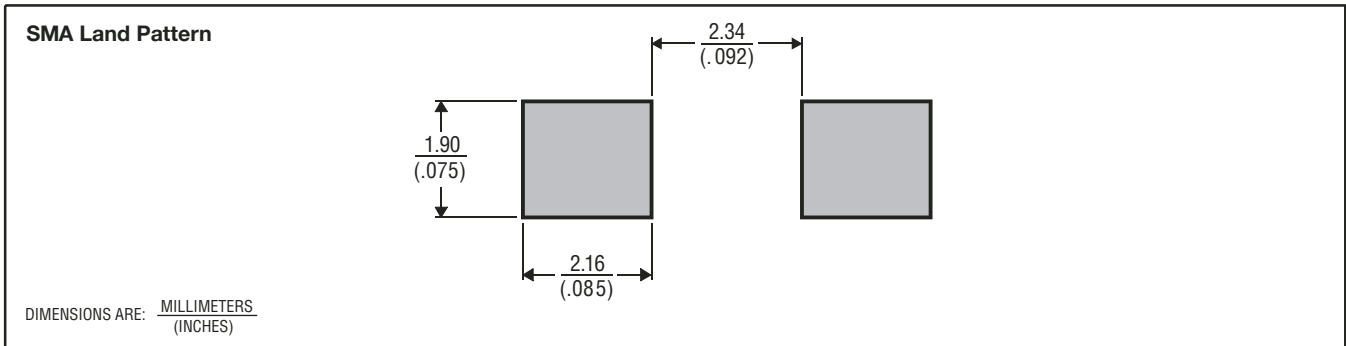

MDXX BIC

Device Symbolization Code

Devices will be coded as below. As the device parameters are symmetrical, terminal 1 is not identified.

Device	Symbolization Code
TISP4070M3AJ	4070M3
TISP4080M3AJ	4080M3
TISP4090M3AJ	4090M3
TISP4095M3AJ	4095M3
TISP4115M3AJ	4115M3
TISP4125M3AJ	4125M3
TISP4145M3AJ	4145M3
TISP4165M3AJ	4165M3
TISP4180M3AJ	4180M3
TISP4200M3AJ	4200M3
TISP4220M3AJ	4220M3
TISP4240M3AJ	4240M3
TISP4250M3AJ	4250M3
TISP4265M3AJ	4265M3
TISP4290M3AJ	4290M3
TISP4300M3AJ	4300M3
TISP4350M3AJ	4350M3
TISP4360M3AJ	4360M3
TISP4395M3AJ	4395M3

Carrier Information

For production quantities, the carrier will be embossed tape reel pack. Evaluation quantities may be shipped in bulk pack or embossed tape.

Carrier	Standard Quantity
Embossed Tape Reel Pack	5,000

"TISP" is a trademark of Bourns, Ltd., a Bourns Company, and is Registered in U.S. Patent and Trademark Office.
"Bourns" is a registered trademark of Bourns, Inc. in the U.S. and other countries.

AUGUST 2001 - REVISED JANUARY 2007
Specifications are subject to change without notice.
Customers should verify actual device performance in their specific applications.

X-ON Electronics

Largest Supplier of Electrical and Electronic Components

Click to view similar products for [Sidacs](#) category:

Click to view products by [Bourns](#) manufacturer:

Other Similar products are found below :

[NP1100SAT3G](#) [NP3100SBT3G](#) [P1201SCLRP](#) [P3800FNLTP](#) [MKP9V160RLG](#) [K2402G](#) [TB2300L-13-F](#) [TB1500M-13-F](#) [P2300MEL](#)
[K1500GRP](#) [SEP0720Q38CB](#) [TB2600H-13-F](#) [TISP4030L1BJR-S](#) [T10B270](#) [P1301DF-1E](#) [K2000GH](#) [TB0900M-13-F](#) [P0304UALRP](#)
[P4202ACL](#) [K1400G](#) [IXBOD1-16RD](#) [P4800MEL](#) [TISP4P035L1NR-S](#) [IXBOD1-30R](#) [TISP4011H1BJR-S](#) [P6002AAL](#) [K1V24-4060](#)
[TISP4180M3BJR-S](#) [G1VL22C-5103](#) [G1VL24C-5103](#) [TISP3072F3DR-S](#) [TISP4015H1BJR-S](#) [TISP4015L1AJR-S](#) [TISP4015L1BJR-S](#)
[TISP4030H1BJR-S](#) [TISP4030L1AJR-S](#) [TISP4040H1BJR-S](#) [TISP4040L1AJR-S](#) [TISP4040L1BJR-S](#) [TISP4070H3BJR-S](#) [TISP4070J3BJR-S](#)
[TISP4070M3BJR-S](#) [TISP4080M3BJR-S](#) [TISP4125H3BJR-S](#) [TISP4145H3BJR-S](#) [TISP4240H3BJR-S](#) [TISP4300M3BJR-S](#) [TISP5150H3BJR-](#)
[S](#) [TISP4C220H3BJR-S](#) [TISP4395H3BJR-S](#)