

As experienced experts we support our customers and partners around the world with products, solutions and services in the industrial environment of power, signal and data. We are at home in their industries and markets and know the technological challenges of tomorrow. We are therefore continuously developing innovative, sustainable and useful solutions for their individual needs. Together we set standards in Industrial Connectivity.

Signal converters, trip amplifiers and process meters Catalogue 2016/2017

Let's connect.

Analogue signal conditioning

Analogue signal conditioning

Catalogue 2016/2017

Weidmüller 

Weidmüller Interface GmbH & Co. KG
Klingenbergstraße 16
32758 Detmold, Germany
T +49 5231 14-0
F +49 5231 14-292083
info@weidmueller.com
www.weidmueller.com

Your local Weidmüller partner can
be found on our website:
www.weidmueller.com/countries

Made in Germany



Order number: 2028820000/11/2015/SMDM



Weidmüller 

Dear Customers,

The PDF versions of our catalogues offer practical additional functions, helping you to find your way around our product range and simplifying the ordering process.

In addition to the catalogue, the PDF also contains:

- Internal page links
- Links to the online catalogue

Try it out for yourself. Click the order number to obtain more detailed information and close-up images via you web browser. The links in the PDF file also enable you to go directly to the next desired catalogue page.

Further Weidmüller product catalogues can be accessed by clicking the following:



Signal converters, trip amplifiers and process meters

Catalogue 4.1

Signal converters, trip amplifiers and process meters

Product overview - Analogue Signal Conditioning

Intrinsically safe signal conditioners for hazardous area applications

Signal converters in 6 mm width

Signal converters

Trip amplifier for monitoring AC/DC circuits

Indicators and configurable displays

Accessories Analogue Signal Conditioning

Contents

A

B

C

D

E

F

G

Appendix

Technical appendix/Glossary

Index

Search according to type or order number

W

X

Signal converters, trip amplifiers and process meters

Intrinsically safe signal converters – ACT20X Page B.4



- Analogue and binary signal interfaces to Ex Zone 0 / Division 1
- FDT/DTM software configurable
- 2 channel modules in 22.5 mm housing

Signal converter, 6 mm – ACT20M Page C.4



- Isolating and converting of temperature signals and DC signals (3-way isolation, supply isolators and passive isolators)
- Up to 2 channels with a width of 6 mm
- Power supply via the CH20M DIN rail bus

Signal converter and monitoring components, 6 mm – MCZ Page C.30

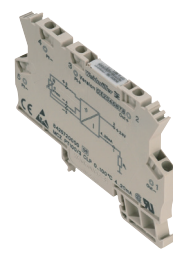

- Signal converter in terminal format
- Passive isolator, temperature/frequency converter and threshold monitoring
- Simple wiring with pluggable cross-connection channels

Network-compatible signal converters ACT20C Page D.6



- Separation and conversion of current or voltage signals
- Limit value monitoring, diagnosis, monitoring via Ethernet networks
- PC configuration with FDT/DTM software

Signal converters and monitoring components – ACT20P Page D.8



- Separation and conversion of temperature and DC signals (3-way isolation, supply isolators and passive isolators)
- Strain gauge transmitter for reading from load cells
- High levels of galvanic isolation and accuracy

Signal converters – WAVE Page D.18



- Separation and conversion of temperature and DC signals (3-way isolation, supply isolators and passive isolators)
- A large selection of standard signal- and measurement isolating transformers
- High level of galvanic isolation

Interface converters Page D.74



- RS232/ RS485/ TTY interface converter in WAVE housing
- RS232 connection with SUB-D connector
- Bi-direction communication enabled

Trip amplifiers for monitoring – WAVE Page E.2



- Monitoring DC and AC currents and voltages
- Current/voltage ranges and switching points can be set manually.
- Pluggable units for monitoring current – on DIN rail base

Displays Page F.2



- Large four-character LED display
- 1/8"-DIN-standard front-panel with IP 65 protection
- Integrated signal converter and trip amplifier

Configuration adapter

Page G.4



- USB interface adapter for configuring signal converters
- Compatible with ACT20X, WAVE TTA and ITX+ modules
- Simple installation with plug-in connector

Markers and cross-connectors

Page G.12

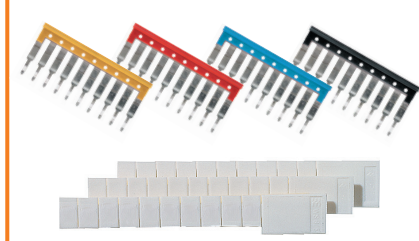

- Suitable MultiCard markers for all modules
- Pluggable cross-connectors for WAVE, MCZ and MICROSERIES

Calibration device

Page G.14



- Measures and simulates voltage and current signals
- Adjustable continuous level and ramping functions
- Easy to adjust with buttons on front

Product overview – Analogue Signal Conditioning

Product overview – Analogue Signal Conditioning	Introduction	A.2
	Quick select – Analogue Signal Conditioning	A.4

Analogue Signal Conditioning Qs and As

Where are analogue conditioners used?

In all types of electronic industrial and marine measurement and control systems – for example in processes such as power plants, steelworks, water and waste plants, oil and gas production and chemical processing. In fact, wherever temperature, pressure, level, flow, weight, speed, etc., is measured and controlled as part of a continuous or batch production process. Such measurement parameters – after being accurately produced – must not be degraded on their way from the field to the control room, despite external influences from the atmosphere and installation. Conversion or changes to these signals requires electronics of the highest quality, which can also withstand wide ambient temperature changes, electro-magnetic interference, vibration, corrosive or hazardous conditions.

What functions do analogue conditioners provide?

One or more of the following:

- 1) Isolation of high level DC measurement and control signals. (Why do we need isolation? – see the notes that follow later in this catalogue.)
- 2) Conversion of high level signals, such as 0...5 V input to 4...20 mA output
- 3) Amplification, linearisation and transmission of low-level sensor inputs, such as millivolts from thermocouples, into high level DC outputs to enable transmission over distances 100 m or more.
- 4) Initiation of status indications and alarms by creating relay contact closure outputs from analogue inputs.



Why do we need separate analogue modules nowadays? Surely the control system (PLC or DCS) can perform the same functions?

- 1) Sometimes this is true, but look at where the cabling from the field devices (transmitters, sensors, valves and actuators) needs to go. It will usually go not just straight to the control system. Many signals are also passed to local indicators and alarms, and each will need isolating from the others.
- 2) Often sensors - like thermocouples for temperature – need isolating, converting and linearising locally to a standardised high level signal (e.g. 4...20 mA) for long distance transmission – instead of running expensive compensation cable to the control system.
- 3) Where the control system has no isolated analogue inputs, a separate isolator will often be needed.
- 4) Where the control system cannot provide power for the sensor / transmitter and it is convenient to do this from an isolating module.
- 5) Where a high integrity, dedicated display is required, separate from the control system display, and the input needs splitting.
- 6) Where local linearisation is needed for a plant operator – for example where a liquid volume indicator is needed for filling a bulk storage tank, but the measurement is level (level to volume conversion depends on the shape of the tank).
- 7) Where the control system only takes 4...20 mA analogue inputs and the sensors provide other less common ranges, such as 0...20 mV, 2...10 V, 0...10 k Ω , 0...1 mA, 4...12 kHz, 0...5 A AC etc
- 8) Where the control system needs to be protected from electrical noise pulses on it's analogue inputs
- 9) Where expansion of the analogue inputs would mean an expensive new I/O board for the control system

How can I select the right product for my application?

- 1) Weidmüller has a formidable range of analogue conditioners, covering most application requirements, and our range is expanding. We also have some useful tools for selection and configuration.
- 2) If you cannot find a suitable product for your application, it doesn't mean we don't have one! Tell us your requirement, and if we can't provide a solution from our current range of products, there may be a customised version that we could create for you.



Quick select – Analogue Signal Conditioning

Quick select – Analogue Signal Conditioning

Selection table

Order No.	Product	Input										Miscellaneous	Sensor feed	Width	
		Amount	0...20 mA	4...20 mA	0...10 V	0...5 V	TC	RTD	Frequency						
Intrinsically safe signal converter for the Ex zone															
8965340000	ACT20X-HDI-SDO-RNO-S	1											Namur Initiator		22.5 mm
8965350000	ACT20X-HDI-SDO-RNC-S	1											Namur Initiator		22.5 mm
8965370000	ACT20X-2HDI-2SDO-RNO-S	2											Namur Initiator		22.5 mm
8965380000	ACT20X-2HDI-2SDO-RNC-S	2											Namur Initiator		22.5 mm
8965360000	ACT20X-HDI-SDO-S	1											Namur Initiator		22.5 mm
8965390000	ACT20X-2HDI-2SDO-S	2											Namur Initiator		22.5 mm
8965400000	ACT20X-SDI-HDO-L-S	1											NPN PNP switching signal		22.5 mm
8965420000	ACT20X-2SDI-2HDO-S	2											NPN PNP switching signal		22.5 mm
8965410000	ACT20X-SDI-HDO-H-S	1											NPN PNP switching signal		22.5 mm
8965470000	ACT20X-HTI-SAO-S	1	X					X	X						22.5 mm
8965480000	ACT20X-2HTI-2SAO-S	2	X					X	X						22.5 mm
8965490000	ACT20X-HUI-SAO-S	1	X	X	X	X	X	X	X					X	22.5 mm
1318220000	ACT20X-HUI-SAO-LP-S	1	X	X	X	X	X	X	X						12.5 mm
8965430000	ACT20X-HAI-SAO-S	1		X									HART®-transparent	X	22.5 mm
8965440000	ACT20X-2HAI-2SAO-S	2		X									HART®-transparent	X	22.5 mm
8965450000	ACT20X-SAI-HAO-S	1		X									HART®-transparent		22.5 mm
8965460000	ACT20X-2SAI-2HAO-S	2		X									HART®-transparent		22.5 mm
Signal converter in 6 mm width															
1176020000	ACT20M-AI-2SAO-S	1	X	X	X	X								X	6.1 mm
1175990000	ACT20M-CI-2CO-S	1	X	X											6.1 mm
1176000000	ACT20M-AI-AO-S	1	X	X	X	X								X	6.1 mm
1176010000	ACT20M-AI-AO-E-S	1	X	X	X	X									6.1 mm
1175980000	ACT20M-CI-CO-S	1	X	X											6.1 mm
1176030000	ACT20M-UI-AO-S	1	X	X	X	X	X	X						X	6.1 mm
1176070000	ACT20M-CI-CO-ILP-S	1	X	X											6.1 mm
1176080000	ACT20M-2CI-2CO-ILP-S	2	X	X											6.1 mm
1176040000	ACT20M-CI-CO-OLP-S	1	X	X										X	6.1 mm
1176050000	ACT20M-2CI-2CO-OLP-S	2	X	X										X	6.1 mm
1375450000	ACT20M-BAI-AO-S	1											-10(20)...+10(20) mA, -5(10)...+5(10) V		6.1 mm
1375470000	ACT20M-BAI-2AO-S	1											-10(20)...+10(20) mA, -5(10)...+5(10) V		6.1 mm
1375480000	ACT20M-TCI-AO-S	1					X								6.1 mm
1375500000	ACT20M-TCI-AO-E-S	1					X								6.1 mm
1375510000	ACT20M-RTI-AO-S	1						X							6.1 mm
1375520000	ACT20M-RTI-AO-E-S	1						X							6.1 mm
1435590000	ACT20M-RTCI-CO-OLP-S	1					X	X							6.1 mm
1435610000	ACT20M-RTCI-CO-EOLP-S	1						X							6.1 mm
8425720000	MCZ PT100/3 CLP 0...100C	1						X							6.1 mm
8483680000	MCZ PT100/3 CLP 0...120C	1						X							6.1 mm
8604420000	MCZ PT100/3 CLP 0...150C	1						X							6.1 mm
8473010000	MCZ PT100/3 CLP 0...200C	1						X							6.1 mm
8473020000	MCZ PT100/3 CLP 0...300C	1						X							6.1 mm
8473000000	MCZ PT100/3 CLP -50C...+150C	1						X							6.1 mm
8604430000	MCZ PT100/3 CLP -40C...100C	1						X							6.1 mm
8411190000	MCZ CCC 0-20mA/0-20mA	1	X												6 mm
8260280000	MCZ SC 0-10V	1			X										6 mm
8227350000	MCZ SC 0-20MA	1	X												6 mm
8461480000	MCZ CFC 0-20MA	1	X												6 mm
8461470000	MCZ VFC 0-10V	1		X											6 mm
Network-compatible signal converters															
1334490000	ACT20C-AI-AO-MTCP-S	1	X	X	X									X	22.5 mm
1510370000	ACT20C-GTW-100-MTCP-S	1											RJ45, Modbus TCP		22.5 mm
1510240000	ACT20C-CMT-10-AD-RC-S	1											0...10 A AC/DC		22.5 mm
1510420000	ACT20C-CMT-60-AD-RC-S	1											0...60 A AC/DC		22.5 mm

Quick select – Analogue Signal Conditioning

Product overview –
Analogue Signal Conditioning

A

Amount	Output				Relay	Miscellaneous	Configuration	Auxiliary power	Rated voltage	Isolation	Connection system	Special characteristics
	0...20 mA	4...20 mA	0...10 V	Relay								
1				X	Relay output, Status relay	Software	24 V DC	300 V	3-way	S	With ATEX approval, intrinsic safety	
1				X	Relay output, Status relay	Software	24 V DC	300 V	3-way	S	With ATEX approval, intrinsic safety	
2				X	Relay output, Status relay	Software	24 V DC	300 V	3-way	S	With ATEX approval, intrinsic safety	
2				X	Relay output, Status relay	Software	24 V DC	300 V	3-way	S	With ATEX approval, intrinsic safety	
1					Transistor output, Status relay	Software	24 V DC	300 V	3-way	S	With ATEX approval, intrinsic safety	
2					Transistor output, Status relay	Software	24 V DC	300 V	3-way	S	With ATEX approval, intrinsic safety	
1					Status relay	Software	24 V DC	300 V	3-way	S	With ATEX approval, intrinsic safety	
2					Status relay	Software	24 V DC	300 V	3-way	S	ATEX approval, intrinsic safety ignition protection IIC	
1					Status relay	Software	24 V DC	300 V	3-way	S	ATEX approval, intrinsic safety ignition protection IIB	
1	X	X			Status relay	Software	24 V DC	300 V	3-way	S	With ATEX approval, intrinsic safety	
2	X	X			Status relay	Software	24 V DC	300 V	3-way	S	With ATEX approval, intrinsic safety	
1	X			X	Limit value relay output, Status relay	Software	24 V DC	300 V	3-way	S	With ATEX approval, intrinsic safety	
1		X				Software	output loop	300 V	2-way	S	With ATEX approval, intrinsic safety, Supply on output side	
1		X			Status relay	Software	24 V DC	300 V	3-way	S	ATEX approval, intrinsic safety, HART®- transparent	
2		X			Status relay	Software	24 V DC	300 V	3-way	S	ATEX approval, intrinsic safety, HART®- transparent	
1		X			Status relay	Software	24 V DC	300 V	3-way	S	ATEX approval, intrinsic safety, HART®- transparent	
2		X			Status relay	Software	24 V DC	300 V	3-way	S	ATEX approval, intrinsic safety, HART®- transparent	
2	X	X	X			DIP switch	24 V DC	300 V	3-way	S	ATEX approval	
2	X	X				DIP switch	24 V DC	300 V	3-way	S	ATEX approval	
1	X	X	X			DIP switch	24 V DC	300 V	3-way	S	ATEX approval	
1	X	X	X			DIP switch	24 V DC	300 V	3-way	S	ATEX approval	
1	X	X				Software	24 V DC	300 V	3-way	S	ATEX approval	
1	X	X				input loop	300 V	2-way	S	ATEX approval, Passive converter		
2	X	X				input loop	300 V	2-way	S	ATEX approval, Passive converter		
1	X	X				output loop	300 V	2-way	S	ATEX approval, Passive converter		
2	X	X				output loop	300 V	2-way	S	ATEX approval, Passive converter		
1	X	X	X			DIP switch	24 V DC	300 V	2-way	S	ATEX approval	
2	X	X	X		2 x -10(20)...+10(20) mA	DIP switch	24 V DC	300 V	2-way	S	ATEX approval	
1	X	X	X		internal CJC, external CJC	DIP switch	24 V DC	300 V	2-way	S	ATEX approval	
1	X	X	X		internal CJC, external CJC	DIP switch	24 V DC	300 V	2-way	S	ATEX approval	
1	X	X	X		0(1)...5 V	DIP switch	24 V DC	300 V	2-way	S	ATEX approval	
1	X	X			0(1)...5 V	DIP switch	24 V DC	300 V	2-way	S	ATEX approval	
1		X			20...4 mA	DIP switch	output loop	300 V	2-way	S	Passive converter, ATEX approval	
1		X			20...4 mA	DIP switch	output loop	300 V	2-way	S	Passive converter, ATEX approval	
1		X					output loop		2-way	Z	Passive converter OLP	
1		X					output loop		2-way	Z	Passive converter OLP	
1		X					output loop		2-way	Z	Passive converter OLP	
1		X					output loop		2-way	Z	Passive converter OLP	
1		X					output loop		2-way	Z	Passive converter OLP	
1		X					output loop		2-way	Z	Passive converter OLP	
1		X					output loop		2-way	Z	Passive converter OLP	
1	X						input loop	100 V	2-way	Z	passive isolator ILP	
2					Limit value transistor output	potentiometer	24 V DC			Z		
2					Limit value transistor output	potentiometer	24 V DC			Z		
1					Frequency: 0...1/ 4/ 8/ 16 kHz	DIP switch	24 V DC	100 V	2-way	Z	Frequency output	
1					Frequency: 0...1/ 4/ 8/ 16 kHz	DIP switch	24 V DC	100 V	2-way	Z	Frequency output	
1	X	X	X		Software	Software	24 V DC	300 V	4-way	S	Network-compatible, Ethernet	
0					Software	Software	24 V DC	30 V	3-way	S	Modbus TCP Gateway	
1	X	X	X	X	± 10 V, ± 20 mA, Limit value relays	Software	24 V DC	300 V	3-way	S	Through hole current monitor	
1	X	X	X	X	± 10 V, ± 20 mA, Limit value relays	Software	24 V DC	300 V	3-way	S	Through hole current monitor	

Connection system: S = screw / Z = tension clamp, ILP (Input Loop Powered) = Input Loop Powered, OLP (Output Loop Powered) = Output Loop Powered

Quick select – Analogue Signal Conditioning

Quick select – Analogue Signal Conditioning

Selection table

Order No.	Product	Amount	0...20 mA	4...20 mA	0...10 V	0...5 V	TC	RTD	Frequency	Input	Sensor feed	Width
										Miscellaneous		
Signal converters												
7760054114	ACT20P-CI-CO	1	X	X						2-/3-wire transmitter	X	12.5 mm
7760054115	ACT20P-CI-2CO	1	X	X						2-/3-wire transmitter	X	12.5 mm
7760054117	ACT20P-2CI-2CO-12	2	X									12.5 mm
8411190000	MCZ CCC 0-20mA/0-20mA	1	X									6 mm
Strain gauge transmitter												
1067250000	ACT20P-BRIDGE-S	1								4-, 6- wire strain gauges	X	22.5 mm
Universal measuring transducer												
1481970000	ACT20P-PRO DCDC II-S	1	X	X	X	X				± 100 mA, ± 300 V	X	12.5 mm
1453210000	ACT20P-UI-AO-DO-LP-S	1	X	X	X	X	X	X		± 25 mA, ± 5 A DC, ± 28 V DC, ± 300 V DC, 300 V AC	X	12.5 mm
1477420000	ACT20P-AI-AO-DC-S	1	X	X	X	X				0...11V, 0...22mA	X	12.5 mm
8939670000	WAS6 TTA	1	X	X	X	X	X	X	X	Adjustable: -200...500 mV -20...50 V	X	45 mm
8939680000	WAZ6 TTA	1	X	X	X	X	X	X	X	2 Hz...100 kHz	X	45 mm
8964310000	WAS6 TTA EX	1	X	X	X	X	X	X	X	RTD, TC, resistor, potentiometer	X	45 mm
8964320000	WAZ6 TTA EX	1	X	X	X	X	X	X	X		X	45 mm
Measuring- and monitoring modules												
7940045760	ACT20P-UI-2RCO-DC-S	1	X	X	X	X	X	X		± 25 mA, ± 5 A DC, ± 30 V DC, ± 300 V DC, potentiometer, Widerstand	X	22.5 mm
8260280000	MCZ SC 0-10V	1			X							6 mm
8227350000	MCZ SC 0-20MA	1	X									6 mm
AC/DC measuring transducer												
1510470000	ACT20P-CMT-10-AO-RCS	1								0...10 A AC/DC		22.5 mm
1510540000	ACT20P-CMT-30-AO-RCS	1								0...30 A AC/DC		22.5 mm
1510440000	ACT20P-CMT-60-AO-RCS	1								0...60 A AC/DC		22.5 mm
8523400000	WAS1 CMA 1/5/10A ac	1								Adjustable: 0...10 A AC		22.5 mm
8523410000	WAZ1 CMA 1/5/10A ac	1								Adjustable: 0...10 A AC		22.5 mm
8528650000	WAS1 CMA LP 1/5/10A ac	1								Adjustable: 0...10 A AC		22.5 mm
8528660000	WAZ1 CMA LP 1/5/10A ac	1								Adjustable: 0...10 A AC		22.5 mm
8975590000	WAS1 CMA LP 1/5/10A EX	1								Adjustable: 0...10 A AC		22.5 mm
DC/DC 3-way isolator												
8447160000	WAS5 CCC HF 0-20/0-20MA	1	X									17.5 mm
8447170000	WAZ5 CCC HF 0-20/0-20MA	1	X									17.5 mm
8447220000	WAS5 CVC HF 0-20/0-10V	1	X									17.5 mm
8447250000	WAS5 CCC HF 4-20/0-20MA	1		X								17.5 mm
8447280000	WAS5 CVC HF 4-20/0-10V	1		X								17.5 mm
8447310000	WAS5 VCC HF 0-10/0-20MA	1			X							17.5 mm
8447340000	WAS5 VCC HF 0-10/4-20MA	1			X							17.5 mm
8447370000	WAS5 VVC HF 0-10/0-10V	1			X							17.5 mm
8447380000	WAZ5 VVC HF 0-10/0-10V	1			X							17.5 mm
8561610000	WAS5 VVC HF +-10V/+-10V	1								-10V ...+10V		17.5 mm
8540180000	WAS5 CCC 0-20/0-20mA	1	X									17.5 mm
8540190000	WAZ5 CCC 0-20/0-20mA	1	X									17.5 mm
8540250000	WAS5 CCC 0-20/4-20mA	1	X									17.5 mm
8540270000	WAS5 CVC 0-20mA/0-10V	1	X									17.5 mm
8540200000	WAS5 CCC 4-20/0-20MA	1		X								17.5 mm
8540230000	WAS5 CVC 4-20mA/0-10V	1		X								17.5 mm
8540310000	WAS5 VCC 0-10V/0-20MA	1			X							17.5 mm
8540320000	WAZ5 VCC 0-10V/0-20MA	1			X							17.5 mm
8540290000	WAS5 VCC 0-10V/4-20MA	1			X							17.5 mm
8540300000	WAZ5 VCC 0-10V/4-20MA	1			X							17.5 mm
8540330000	WAS5 VVC 0-10V/0-10V	1			X							17.5 mm
8540340000	WAZ5 VVC 0-10V/0-10V	1			X							17.5 mm

Quick select – Analogue Signal Conditioning

Product overview –
Analogue Signal Conditioning

A

Amount	Output					Configuration	Auxiliary power	Rated voltage	Isolation	Connection system	Special characteristics
	0...20 mA	4...20 mA	0...10 V	Relay	Miscellaneous						
1	X	X					24 V DC	300 V	3-way	S	HART®- transparent
2	X	X					24 V DC	300 V	3-way	S	HART®- transparent
2	X	X					24 V DC	300 V	3-way	S	HART®- transparent
1	X						input loop	100 V	2-way	Z	passive isolator ILP
1	X	X	X		Reset button (TARE)		10...60 V DC	300 V	3-way	S	
1	X	X	X		± 10 V, ± 20 mA	Display, DIP switch	24 V - 230 V AC/DC	600 V	3-way	S	aktiv or passiv output
1		X			Output Loop powered, NPN output, Limit value	Software	output loop	300 V	3-way	S	Output Loop powered
1	X	X	X		0...11V, 0...22mA	DIP switch, Button, LED	12...60 V DC	300 V	3-way	S	
3	X	X	X	X	1 analogue output	Software	18 V - 230 V AC/DC	300 V	3-way	S	
3	X	X	X	X	2 relay outputs	Software	18 V - 230 V AC/DC	300 V	3-way	Z	
3	X	X	X	X		Software	18 V - 230 V AC/DC	300 V	3-way	S	ATEX approval
3	X	X	X	X		Software	18 V - 230 V AC/DC	300 V	3-way	Z	ATEX approval
1				X	2 x Limit value relay outputs	Software, Display	9...60 V DC	300 V	3-way	S	
2					Limit value transistor output	potentiometer	24 V DC			Z	
2					Limit value transistor output	potentiometer	24 V DC			Z	
1	X	X	X	X	± 10 V, ± 20 mA, Limit value relays	DIP switch, potentiometer	24 V DC	300 V	3-way	S	Through hole current converter
1	X	X	X	X	± 10 V, ± 20 mA, Limit value relays	DIP switch, potentiometer	24 V DC	300 V	3-way	S	Through hole current converter
1	X	X	X	X	± 10 V, ± 20 mA, Limit value relays	DIP switch, potentiometer	24 V DC	300 V	3-way	S	Through hole current converter
1	X	X	X			DIP switch	24 V DC	300 V	2-way	S	
1	X	X	X			DIP switch	24 V DC	300 V	2-way	Z	
1	X	X	X			DIP switch	output loop	300 V	2-way	S	
1	X	X	X			DIP switch	output loop	300 V	2-way	Z	
1	X	X	X			DIP switch	output loop	300 V	2-way	S	ATEX approval
1	X						24 V DC	300 V	3-way	S	
1	X						24 V DC	300 V	3-way	Z	
1			X				24 V DC	300 V	3-way	S	
1	X						24 V DC	300 V	3-way	Z	
1			X				24 V DC	300 V	3-way	S	
1				X			24 V DC	300 V	3-way	Z	
1					-10V ...+10V		24 V DC	300 V	3-way	Z	
1	X						24 V DC	300 V	3-way	S	
1	X						24 V DC	300 V	3-way	Z	
1		X					24 V DC	300 V	3-way	S	
1			X				24 V DC	300 V	3-way	S	
1	X						24 V DC	300 V	3-way	S	
1	X						24 V DC	300 V	3-way	Z	
1		X					24 V DC	300 V	3-way	S	
1			X				24 V DC	300 V	3-way	Z	
1				X			24 V DC	300 V	3-way	S	
1					X		24 V DC	300 V	3-way	Z	

Connection system: S = screw / Z = tension clamp, ILP (Input Loop Powered) = Input Loop Powered, OLP (Output Loop Powered) = Output Loop Powered

Quick select - Analogue Signal Conditioning

Quick select - Analogue Signal Conditioning

Selection table

Order No.	Product	Input										Width
		Amount	0...20 mA	4...20 mA	0...10 V	0...5 V	TC	RTD	Frequency	Miscellaneous	Sensor feed	
DC/DC 2-way isolator												
8444980000	WAS4 CCC DC 4-20/4-20mA	1	X									12.5 mm
8444990000	WAZ4 CCC DC 4-20/4-20mA	1	X									12.5 mm
8445010000	WAS4 CCC DC 4-20/0-20mA	1	X									12.5 mm
8445040000	WAS4 CVC DC 4-20/0-10V	1	X									12.5 mm
8445050000	WAZ4 CVC DC 4-20/0-10V	1	X									12.5 mm
DC/DC passive isolator												
8581160000	WAS5 CCC 20LP	1										17.5 mm
8581170000	WAZ5 CCC 20LP	1										17.5 mm
8975640000	WAS5 CCC 20LP EX	1										17.5 mm
8543720000	WAS5 OLP	1										17.5 mm
8543730000	WAZ5 OLP	1										17.5 mm
8444950000	WAS5 CCC LP 0-20/0-20mA	1	X									17.5 mm
8444960000	WAZ5 CCC LP 0-20/0-20mA	1	X									17.5 mm
8463580000	WAS5 CCC LP 0-20/0-20mA	1	X									17.5 mm
8463590000	WAZ5 CCC LP 0-20/0-20mA	1	X									17.5 mm
Temperature measuring transducer												
8560700000	WAS5 PRO RTD							X				12.5 mm
8560710000	WAZ5 PRO RTD							X				12.5 mm
8679490000	WAS5 PRO RTD 1000							X				12.5 mm
8638950000	WAS5 PRO RTD Cu							X				12.5 mm
8432280000	WTZ4 PT100/4 C 0/4-20mA							X				12.5 mm
8432250000	WTZ4 PT100/4 V 0-10V							X				12.5 mm
8432130000	WTZ4 PT100/3 V 0-10V							X				12.5 mm
8432160000	WTZ4 PT100/3 C 0/4-20mA							X				12.5 mm
8432190000	WTZ4 PT100/2 V 0-10V							X				12.5 mm
8432220000	WTZ4 PT100/2 C 0/4-20mA							X				12.5 mm
8560720000	WAS5 PRO Thermo						X					12.5 mm
8560730000	WAZ5 PRO Thermo						X					12.5 mm
8432300000	WTS4 THERMO						X					12.5 mm
8432310000	WTZ4 THERMO						X					12.5 mm
1375480000	ACT20M-TCI-A0-S	1						X				6.1 mm
1375500000	ACT20M-TCI-A0-E-S	1						X				6.1 mm
1375510000	ACT20M-RTI-A0-S	1						X				6.1 mm
1375520000	ACT20M-RTI-A0-E-S	1						X				6.1 mm
1435590000	ACT20M-RTCI-C0-0LP-S	1					X	X				6.1 mm
1435610000	ACT20M-RTCI-C0-E0LP-S	1					X	X				6.1 mm
8425720000	MCZ PT100/3 CLP 0...100C	1						X				6.1 mm
8483680000	MCZ PT100/3 CLP 0...120C	1						X				6.1 mm
8604420000	MCZ PT100/3 CLP 0...150C	1						X				6.1 mm
8473010000	MCZ PT100/3 CLP 0...200C	1						X				6.1 mm
8473020000	MCZ PT100/3 CLP 0...300C	1						X				6.1 mm
8473000000	MCZ PT100/3 CLP -50C...+150C	1						X				6.1 mm
8604430000	MCZ PT100/3 CLP -40C...100C	1						X				6.1 mm

Quick select – Analogue Signal Conditioning

Amount	Output				Relay	Miscellaneous	Configuration	Auxiliary power	Rated voltage	Isolation	Connection system	Special characteristics
	0...20 mA	4...20 mA	0...10 V									
1		X					24 V DC	300 V	2-way	S		
1			X				24 V DC	300 V	2-way	Z		
1	X						24 V DC	300 V	2-way	S		
1				X			24 V DC	300 V	2-way	S		
1				X			24 V DC	300 V	2-way	Z		
2			X				output loop	300 V	2-way	S		
2			X				output loop	300 V	2-way	Z		
2			X				output loop	300 V	2-way	S	ATEX approval	
1			X				output loop	300 V	2-way	S		
1			X				output loop	300 V	2-way	Z		
1	X						input loop	300 V	2-way	S		
1	X						input loop	300 V	2-way	Z		
2	X						input loop	300 V	2-way	S		
2	X						input loop	300 V	2-way	Z		
1	X	X	X			DIP switch	24 V DC	300 V	3-way	S		
1	X	X	X			DIP switch	24 V DC	300 V	3-way	Z		
1	X	X	X			DIP switch	24 V DC	300 V	3-way	S		
1	X	X	X			DIP switch	24 V DC	300 V	3-way	S		
1	X	X				DIP switch, potentiometer	24 V DC		3-way	Z		
1	X	X				DIP switch, potentiometer	24 V DC		3-way	Z		
1	X	X				DIP switch, potentiometer	24 V DC		3-way	Z		
1	X	X				DIP switch, potentiometer	24 V DC		3-way	Z		
1	X	X				DIP switch, potentiometer	24 V DC		3-way	Z		
1	X	X				DIP switch, potentiometer	24 V DC		3-way	Z		
1	X	X				DIP switch	24 V DC		3-way	S		
1	X	X				DIP switch	24 V DC		3-way	Z		
1	X	X	X			DIP switch	24 V DC		3-way	S		
1	X	X	X			DIP switch	24 V DC		3-way	Z		
1	X	X	X		internal CJC, external CJC	DIP switch	24 V DC	300 V	2-way	S	ATEX approval	
1	X	X	X		internal CJC, external CJC	DIP switch	24 V DC	300 V	2-way	S	ATEX approval	
1	X	X	X		0(1)...5 V	DIP switch	24 V DC	300 V	2-way	S	ATEX approval	
1	X	X			0(1)...5 V	DIP switch	24 V DC	300 V	2-way	S	ATEX approval	
1		X			20...4 mA	DIP switch	output loop	300 V	2-way	S	Passive converter, ATEX approval	
1		X			20...4 mA	DIP switch	output loop	300 V	2-way	S	Passive converter, ATEX approval	
1		X					output loop		2-way	Z	Passive converter OLP	
1		X					output loop		2-way	Z	Passive converter OLP	
1		X					output loop		2-way	Z	Passive converter OLP	
1		X					output loop		2-way	Z	Passive converter OLP	
1		X					output loop		2-way	Z	Passive converter OLP	
1		X					output loop		2-way	Z	Passive converter OLP	
1		X					output loop		2-way	Z	Passive converter OLP	

Connection system: S = screw / Z = tension clamp, ILP (Input Loop Powered) = Input Loop Powered, OLP (Output Loop Powered) = Output Loop Powered

Quick select – Analogue Signal Conditioning

Selection table

Order No.	Product	Input									Miscellaneous	Sensor feed	Width
		Amount	0...20 mA	4...20 mA	0...10 V	0...5 V	TC	RTD	Frequency				
Frequency measuring transducer													
8581180000	WAS4 PRO Freq							X	2-, 3-Draht PNP/NPN; Namur Initiator, Gegentaktstufe				12.5 mm
8581190000	WAZ4 PRO Freq							X	Namur Initiator, push-pull step				12.5 mm
8461480000	MCZ CFC 0-20mA	1	X									6 mm	
8461470000	MCZ VFC 0-10V	1		X								6 mm	
Voltage measuring transducer													
8581220000	WAS2 VMA V ac										Adjustable: 0...450 V AC	22.5 mm	
8581230000	WAZ2 VMA V ac										Adjustable: 0...450 V AC	22.5 mm	
Interface converters													
8615700000	WDS2 RS232/RS485/422	1									RS232/RS485/422		
8615690000	WDS2 RS232/TTY	1									RS232/TTY		
Limit monitoring													
8543820000	WAS5 DC/Alarm	1	X	X	X							17.5 mm	
8543880000	WAZ5 DC/Alarm	1	X	X	X							17.5 mm	
Current monitoring													
8742610000	PAS CMR 0.5...2.5 A DC										0.5...2.5 A DC	15.3 mm	
8742620000	PAS CMR 2.0...5.0 A DC										2.0...5.0 A DC	15.3 mm	
8742630000	PAS CMR 4.5...10 A DC										4.5...10 A DC	15.3 mm	
Voltage monitoring													
8705640000	WAS5 VMR 1ph										24...260 V AC/DC 1-phase	17.5 mm	
8705630000	WAS2 VMR 3ph										80...250 V AC/DC 3-phase	22.5 mm	
8978580000	CBX200	1									ACT20X		

Quick select – Analogue Signal Conditioning

Product overview –
Analogue Signal Conditioning

A

Amount	Output				Relay	Miscellaneous	Configuration	Auxiliary power	Rated voltage	Isolation	Connection system	Special characteristics
	0...20 mA	4...20 mA	0...10 V									
1	X	X	X				DIP switch	24 V DC	300 V	3-way	S	
1	X	X	X				DIP switch	24 V DC	300 V	3-way	Z	
1						Frequency: 0...1/ 4/ 8/ 16 kHz	DIP switch	24 V DC	100 V	2-way	Z	Frequency output
1						Frequency: 0...1/ 4/ 8/ 16 kHz	DIP switch	24 V DC	100 V	2-way	Z	Frequency output
1	X	X					DIP switch	24 V DC	300 V	3-way	S	
1	X	X					DIP switch	24 V DC	300 V	3-way	Z	
1						RS232/RS485/422	DIP switch	24 V DC		3-way	S	
1						RS232/TTY	DIP switch	24 V DC		3-way	S	
2				X			DIP switch, potentiometer	24 V DC	300 V	3-way	S	
2				X			DIP switch, potentiometer	24 V DC	300 V	3-way	Z	
1				X						2-way	S	
1				X						2-way	S	
1				X						2-way	S	
1				X		Monitoring of low and surge voltages	DIP switch, potentiometer	input loop	300 V	3-way	S	Adjustable switching thresholds
1				X		Monitoring of low and surge voltages	DIP switch, potentiometer	input loop	600 V	2-way	S	Adjustable switching thresholds
1							Software	USB				Programming accessories

Connection system: S = screw / Z = tension clamp, ILP (Input Loop Powered) = Input Loop Powered, OLP (Output Loop Powered) = Output Loop Powered

Intrinsically safe signal conditioners for hazardous area applications

Contents

Intrinsically safe signal conditioners for hazardous area applications	Intrinsically safe signal conditioners for hazardous area applications – Overview	B.2
	ACT20X – Overview	B.4
	Current supply isolator	B.6
	Current output isolator	B.8
	Temperature transducer	B.10
	Universal measurement and signal isolator-converter	B.12
	NAMUR isolating switching amplifier	B.16
	Valve control module	B.20

Intrinsically safe signal conditioners for hazardous area applications

B

Intrinsically safe signal conditioners for hazardous area applications

ACT20X signal converters

The ACT20X is a completely new line of signal converter products for the Ex zone. These compact modules require only 11 mm per channel and take up very little space in the electrical cabinet. Weidmüller has specifically designed the ACT20X line for process automation applications in Ex and non-Ex zones. The 17 different variants can process all standard input signals (such as 2-wire, HART®, NAMUR-, RTD, thermocouple or DC signals) from Ex zone 0. They can also handle digital or analogue signals from Ex-zone field devices to the controller. The integrated relay output issues an alert in the event of a malfunction; this makes troubleshooting easier and reduces facility down times. The WI-Manager configuration software is based on FDT (Field Device Tool) technology. The software allows you to configure all ACT20X products with your PC so that they can be custom-fit to a wide variety of process applications. Weidmüller provides a device type manager (DTM) for the ACT20X modules that can be used in any FDT-based frame. The DTMs allow you to configure different devices quickly and accurately. They also enable you to analyse measurements and diagnostics data. The DTM can also be used to clearly identify the connected device. The FDT frame application "WI Manager" and the device-specific DTMs are available from Weidmüller free of charge. The ACT20X modules can be used in a temperature range from -20 °C to +60 °C without limitations. The modules can be installed in the safe zone or in the explosion risk area of Zone 2. The ACT20Xs always deliver a pure, interference-free signal

thanks to their accuracy, temperature stability and high insulation strength. They can easily be used around the globe since they already have all the necessary international approvals, including ATEX, ICEEX, GOST and FM.

The newest member of the ACT20X family is the ACT20X-HUI-SAO-LP. This offers an intrinsically safe input for 0/4 to 20 mA, 0 to 10 V, temperature and resistance signals, and separates the Ex zone from the safe zone. The narrow 12.5 mm module is supplied via the 4 to 20 mA output.

Features

- International approvals for Zone 0, 1 and 2 (IECEx, ATEX) and Class 1 Division 1 and 2 (FM)
- Analogue and binary signal interface to Zone 0/Div.1 for explosion-risk inputs and outputs
- All standard input signals (4 to 20 mA HART®, NAMUR-, RTD- or thermocouple signals) out of Ex zone 0, 1 or 2
- Two-channel type saves space in the electrical cabinet and reduces installation costs
- HART® transparent signal isolator
- Integrated alarm contact
- Configuration over FDT/DTM standard with the frame application "WI Manager"



B



ACT20X

ACT20X – intrinsic safety signal conditioners for hazardous areas

PC-configurable conditioners family for hazardous areas in the new Weidmüller electronics housing for installation in safe or hazardous areas.

B ACT20X meets the arduous requirements of the process industry where potentially explosive fluids are controlled. The range connects to sensors and actuators in the hazardous area, isolates their signals and limits the energy passed to them. On the input side ACT20X models can process d.c.,

temperature, Namur and volt-free contact signals. On the output side field devices in the Ex area are controlled via the ACT20X with analogue or digital signals. All ACT20X products are characterised by insulation, accuracy and high temperature stability. The digital 2-channel versions with width of 22.5 mm are available with either transistor or relay output. Due to this high component density, the space requirements and installation costs are reduced accordingly.



Intrinsically safe signal conditioners for hazardous area applications

B



Configuration via FDT

All modules can be quickly and conveniently configured with manufacturer-independent FDT/DTM software.



Worldwide application

Fulfills the strict standards and requirements of the process industry. Can be used worldwide due to international and local approvals ATEX, IECEx, CULUS, FM, GOST and DNV.



Intelligent connection system

Pluggable, coded, with release lever. The release lever simplifies maintenance and allows disconnection without damaging the cables.

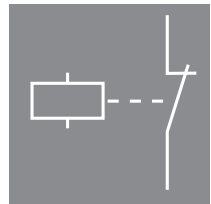

Alarm function

No laborious troubleshooting. Alarm function integrated for cable or sensor errors. In case of failures, a diagnostic signal is sent to the control system.

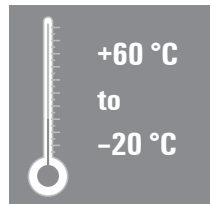

Robust

Wide ambient temperature range from - 20 °C ... + 60 °C.



SIL certification according 61508

Available for safety functions, e.g. switching aggregates on/off, monitoring actuators or temperature/pressure.

	Current supply isolator, HART® Transparent
	Current output isolator, HART® Transparent
	Temperature transducer
	Universal measurement and signal isolator/converter
	NAMUR disconnect-switch amplifier
	Valve control component

ACT20X

Current supply isolator, HART® Transparent

The ACT20X-HAI-SAO current supply isolator is a HART®-protocol transparent signal isolator for analogue input signals from Ex zone 0. It provides an analogue signal for the safe zone on the output side. It is available in a single-channel or double-channel version.

EX area Zone 0, 1, 2, 20, 21, 22

Safe area Zone 2 / FM Class 1, Division 2

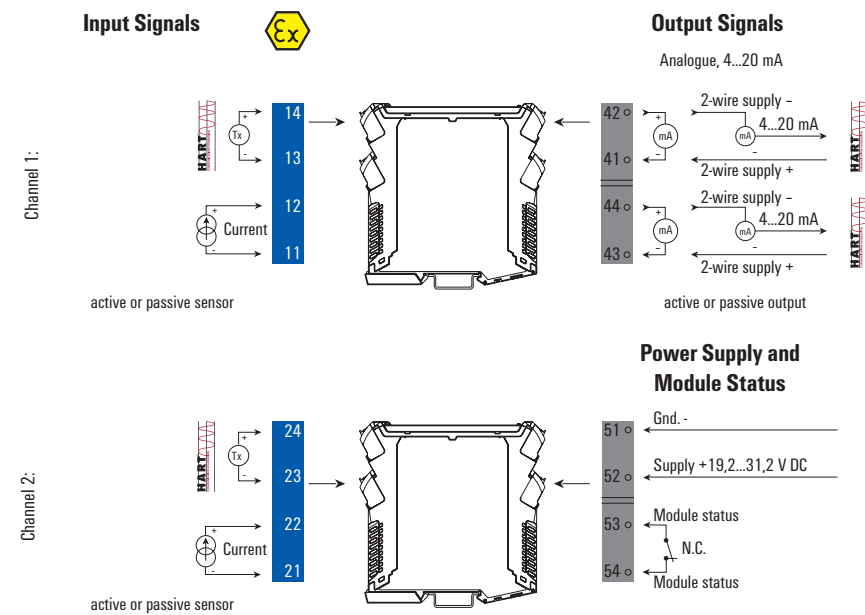

Ex label (excerpt)

ATEX	FM	U _o /U _i	0 V / 30 V
II 3 G Ex nA nC IIC T4 Gc	Installation in CL I DIV2 GP A-D T4	L _o /L _i	0 mA / 120 mA
II (1) G [Ex ia Ga] IIC/IIA	KI. HII ABT 1/2 GP A-G or	P _o /P _i	0 mW / 0,85 W
II (1) D [Ex ia Da] IIC	KI. I Zn2 AEx/Ex nA nC [ia] IIC T4	L _i	0 μH
Example:	Example:	C _i	2 nF
IECEX	ATEX version,	IIC	C _o = 0,08 μF, L _o = 3 mH
Ex nA nC IIC T4 Gc	Ex input, External Current Source:	IIB	C _i = 0,6 μF, L _i = 12 mH
[Ex ia Ga] IIC/IIA	(More details in ATEX certificate)	IIA	C _o = 2,15 μF, L _o = 25 mH

Application example:

Measuring temperature with a head transmitter, signal transmission with HART®

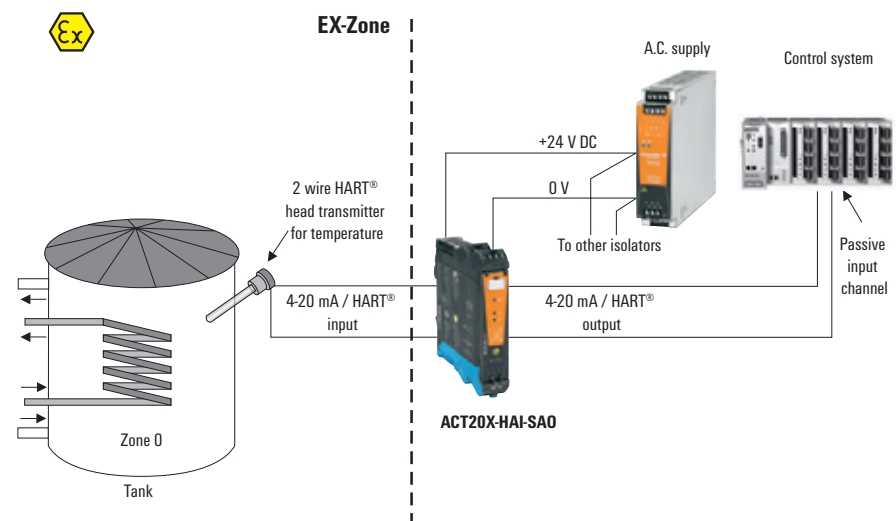

ACT20X

Current supply isolator

- Converts analogue signals from Ex zone 0 into analogue output signals for safe zones.
- Active and passive current inputs/outputs
- HART® - transparent
- PC configuration with FDT/DTM software, download link at www.weidmueller.com
- Relay output for failure alarm
- 2-channel module, can also be used as a signal splitter

ACT20X-HAI-SAO-S / 2HAI-2SAO-S

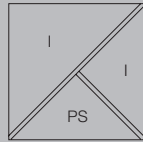

Technical data

Input	
Input current	4...20 mA
Sensor supply	≤ 28 V DC
Residual ripple (current loop)	< 7.5 mV _{rms}
Output analogue	
Output current	4...20 mA
Output signal limit	< 28 mA
load impedance current	≤ 600 Ω
2-wire supply	≤ 26 V DC
Accuracy	< 0.1% span
Temperature coefficient	< 0.01% of span/°C (TU)
Step response time	≤ 5 ms
Cut-off frequency (-3 dB)	0.5...2.5 kHz @ 3.5...23 mA bi-directional HART® signal
Alarm output	
Type	Relay, 1 NC (voltage-free)
Nominal switching voltage	≤ 125 V AC / 110 V DC (safe area) ≤ 32 V AC / 32 V DC (Zone 2)
Continuous current	≤ 0.5 A AC / 0.3 A DC (safe zone), ≤ 0.5 A AC / 1 A DC (Zone 2)
Power rating	≤ 62.5 VA / 32 W (safe area) ≤ 16 VA / 32 W (Zone 2)
General data	
Supply voltage	19.2 - 31.2 V DC
Power consumption	≤ 3 W (2 channels)
Ambient temperature / Storage temperature	/ -20 °C...60 °C / -20 °C...85 °C
Approvals	
Approvals	cULus; DEKRAATEX; DETNORVER; EAC; FMEX; GOSTEX; GOSTME25; IECExDEK
Insulation coordination	
Insulation voltage	2.6 kV (input / output)
Rated voltage	300 V
EMC standards	DIN EN 61326, NE 21

Dimensions	
Clamping range (nominal / min. / max.)	mm ²
Depth x width x height	mm

Screw connection, Removable terminal block	
	2.5/0.5/2.5
	113.6/22.5/117.2

Ordering data

Type	Qty.	Order No.
1-channel version		
ACT20X-HAI-SAO-S	1	8965430000
2-channel version		
ACT20X-2HAI-2SAO-S	1	8965440000

CBX200 USB configuration adapter - 8978580000

Intrinsically safe signal conditioners for hazardous area applications

B

ACT20X

Current output isolator, HART® Transparent

The ACT20X-SAI-HAO current output isolator is HART®-transparent. The input is connected to the safe area controller or PLC, and the output is connected to an analog actuator in a hazardous area, e.g. Zone 0. It is available in a single-channel or double-channel version.

EX area Zone 0, 1, 2, 20, 21, 22

Safe area Zone 2 / FM Class 1, Division 2

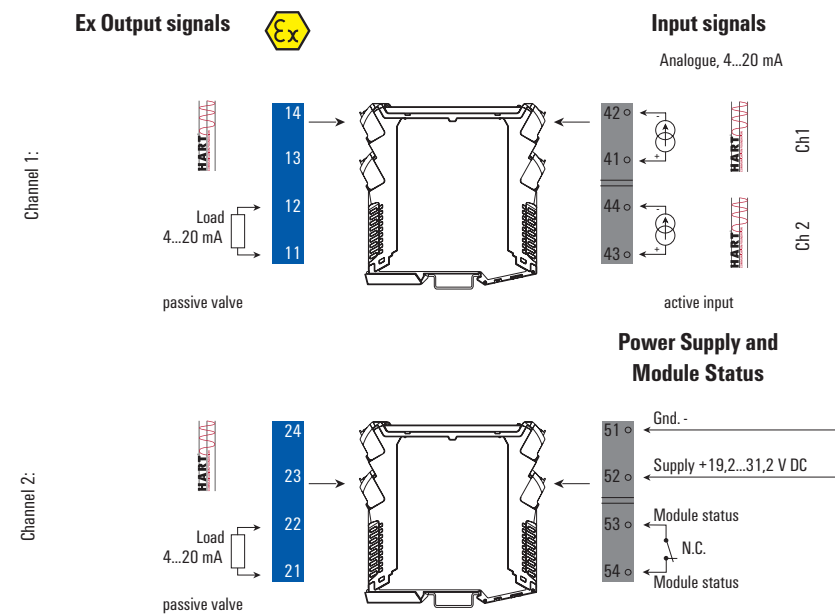

Ex label (excerpt)

ATEX	FM	U _o	28 V
II 3 G Ex nA nC IIC T4 Gc	Installation in CL I DIV2 GP A-D T4	I _e	93 mA
II (1) G [Ex ia Ga] IIC/IIA	KI, HII ABT 1/2 GP A-G or	P _o	0.65 W
II (1) D [Ex ia Da] IIC	KI, I Zn2 AEx/Ex nA nC [ia] IIC T4	IIC	C _o = 0.08 µF, L _o = 4 mH
IECEx	Example:	IIB	C _o = 0.65 µF, L _o = 16 mH
Ex nA nC IIC T4 Gc	ATEX version,	IIA	C _o = 2.15 µF, L _o = 32 mH
[Ex ia Ga] IIC/IIA	Ex output,		
[Ex ia Da] IIC	(More details in ATEX certificate)		



Application example: controlling an actuator in the Ex zone.

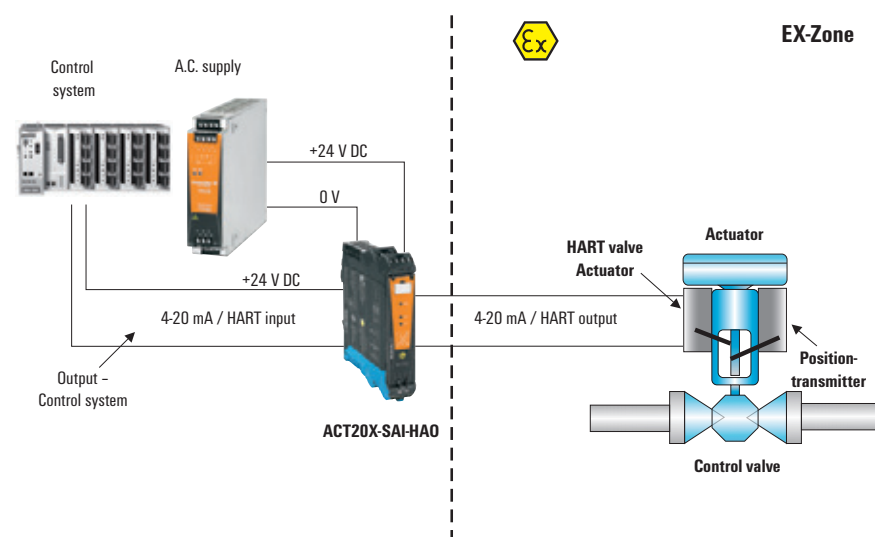

ACT20X

Current output isolator

- For controlling field devices located in explosion risk zones
- HART® Transparent
- Relay output for error alarm
- PC configuration with FDT/DTM software, download at www.weidmueller.com
- 1 or 2 channels in one module

ACT20X-SAI-HAO-S / 2SAI-2HAO-S

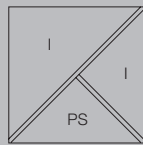

Technical data

Input	
Input current	4...20mA
Voltage drop	< 2 V
Output analogue	
Output current	4...20 mA (max. 23 mA)
Output signal limit	< 28 mA
load impedance current	≤ 725 Ω
2-wire supply	> 14.5 V @ 20 mA
Residual ripple (current loop)	< 7.5 mV _{eff}
Accuracy	< 0.1% span
Temperature coefficient	< 0.01% of span/°C (TU)
Step response time	≤ 5 ms
Cut-off frequency (-3 dB)	0.5...2.5 kHz @ 3.5...23 mA bi-directional HART® signal
Alarm output	
Type	Relay, 1 NC (voltage-free)
Nominal switching voltage	≤ 125 V AC / 110 V DC (safe area) ≤ 32 V AC / 32 V DC (Zone 2)
Continuous current	≤ 0.5 A AC / 0.3 A DC (safe zone), ≤ 0.5 A AC / 1 A DC (Zone 2)
Power rating	≤ 62.5 VA / 32 W (safe area) ≤ 16 VA / 32 W (Zone 2)
General data	
Supply voltage	19.2 - 31.2 V DC
Power consumption	≤ 3 W (2 channels)
Ambient temperature / Storage temperature	/ -20 °C...60 °C / -20 °C...85 °C
Approvals	
Approvals	cULus; DEKRAATEX; DETNORVER; EAC; FMEX; GOSTEX; GOSTME25; IECExDEK
Insulation coordination	
Insulation voltage	2.6 kV (input / output)
Rated voltage	300 V
EMC standards	DIN EN 61326, NE 21

Dimensions	
Clamping range (nominal / min. / max.)	mm ²
Depth x width x height	mm

Screw connection, Removable terminal block	
	2.5/0.5/2.5
	113.6/22.5/117.2

Ordering data

Type	Qty.	Order No.
1-channel version		
ACT20X-SAI-HAO-S	1	8965450000
2-channel version		
ACT20X-2SAI-2HAO-S	1	8965460000

CBX200 USB configuration adapter - 8978580000

Intrinsically safe signal conditioners for hazardous area applications

B

ACT20X

Temperature transducer

The ACT20X-HTI-SAO temperature transducer processes temperature signals from PT100 sensors and thermocouples originating in the Ex zone. A current signal (mA) can also be connected as the input signal. The input is part of an intrinsically safe circuit (Zone 0). The isolated milliamp analogue output is the input to the receiver or controller in the safe area. It is available in a single-channel or double-channel version.

EX area Zone 0, 1, 2, 20, 21, 22

Safe area Zone 2 / FM Class 1, Division 2

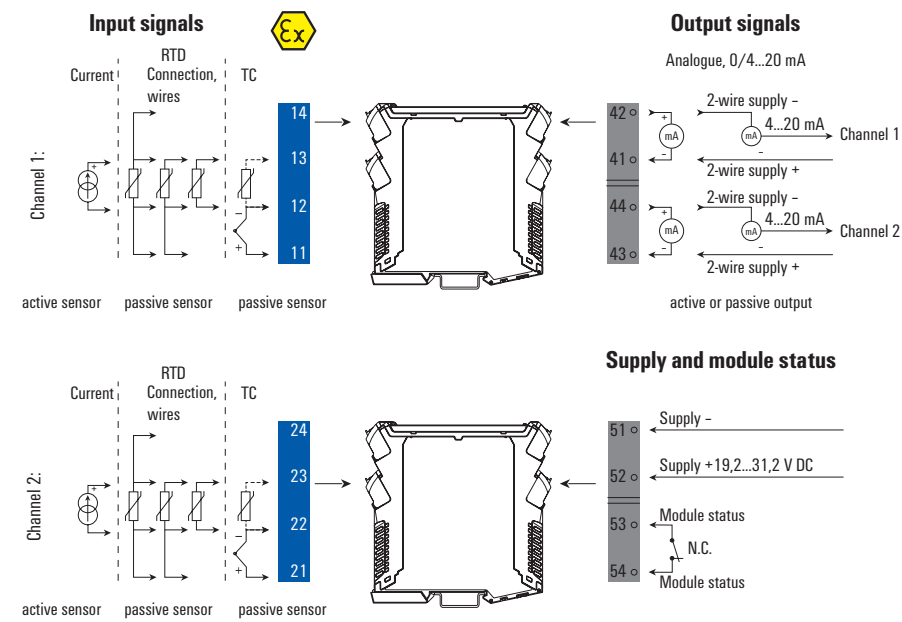

Ex label (excerpt)

ATEX	FM	U_o/U_i	8.7 V / 10 V
II 3 G Ex nA nC IIC T4	Installation in CL I DIV2 GP A-D T4	L_o/L_i	18.4 mA / 30 mA
II (1) G [Ex ia] IIC/IIA	KI. HII ABT 1/2 GP A-G or	P_o	400 mW
II (1) D [Ex iaD]	KI. I Zn2 AEx/Ex nA nC [ia] IIC T4	$L_o/R_o/L_i$	892 μ H/ Ω / 820 nH
	Example:	C_o	30 nF
IECEx	ATEX version,	IIC	$C_o = 5 \mu$ F, $L_o = 100$ mH
Ex nA nC IIC T4 Gc	Ex input Temperature,	IIA	$C_o = 50 \mu$ F, $L_o = 300$ mH
[Ex ia Ga] IIC/IIA	(More details in ATEX certificate)	IIA	$C_o = 1000 \mu$ F, $L_o = 700$ mH

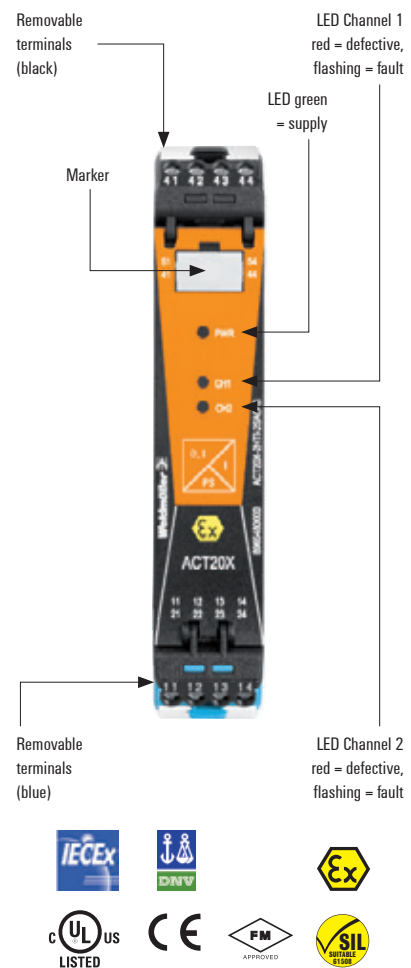

Application example: temperature measurements in the Ex zone

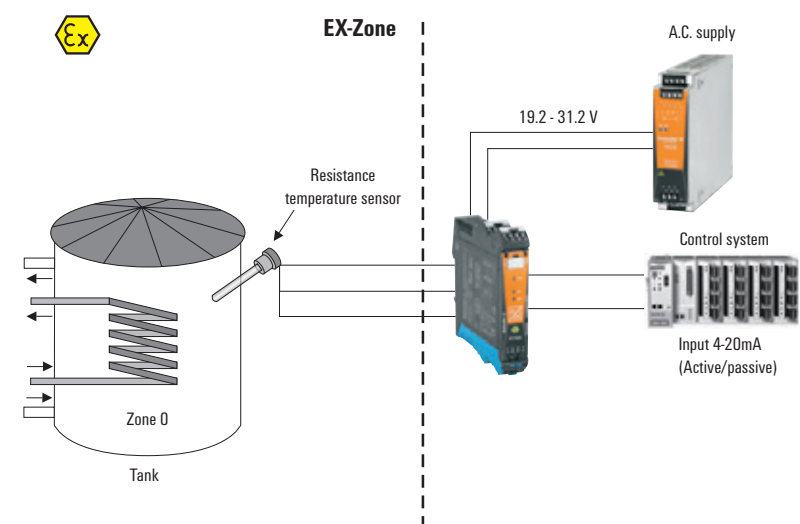

Accuracy / temperature coefficients

ACT20X-HTI-SAO

Input	Accuracy	Temperature coefficient
Input mA	$\leq \pm 4 \mu$ A	$\leq \pm 4 \mu$ A / °C
Input RTD		
Pt100	$\leq \pm 0.2$ °C	$\leq \pm 0.02$ °C / °C
Ni100	$\leq \pm 0.3$ °C	$\leq \pm 0.03$ °C / °C
Input TC		
Type B	$\leq \pm 4.5$ °C	$\leq \pm 0.45$ °C / °C
Type E, J, K, L, N, T, U	$\leq \pm 1$ °C	$\leq \pm 0.1$ °C / °C
Type R, S, W3, W5, LR	$\leq \pm 2$ °C	$\leq \pm 0.2$ °C / °C
Note		

Intrinsically safe signal conditioners for hazardous area applications

B

Temperature transducer

- Converts intrinsically safe RTD, thermocouple and mA signals into analogue signals for safe zones.
- PC configuration with FDT/DTM software, download link at www.weidmueller.com
- Relay output for failure alarm
- 1 or 2 channels in one module
- 2-channel module, can also be used as a signal splitter

ACT20X-HTI-SA0-S / 2HTI-2SA0-S

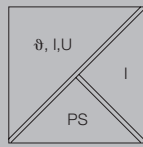

Usable as:

- Safety barrier (insulator)
- Signal conversion
- 2-wire measuring transducer
- Amplifier, repeater

Technical data

Input	
Type	intrinsically safe circuit, RTD, TC, DC (mA)
Sensor supply	
Temperature input range	Configurable
Line resistance in measuring circuit	≤ 50 Ω
Input current	0...20 mA, 4...20mA
Input resistance, current	20 Ω + PTC 50 Ω

Output	
Output current	0...23 mA, configurable: 0...20 / 4...20 / 20...0 / 20...4 mA, configurable downscale (3.5 mA) / upscale (23 mA) @ error
Output signal limit	3.8...20.5 mA / 0...20.5 mA (dependent on range)
load impedance current	≤ 600 Ω
Influence of load resistance	≤ 0.01% of span / 100 Ω

Current loop output	
Output current (current loop)	4...20 mA
Load resistance	(U _s - 3.5) / 0.023 A
Influence of load resistance	≤ 0.01% of span / 100 Ω
2-wire supply	3.5...26 V DC

Alarm output	
Type	Relay, 1 NC (voltage-free)
Nominal switching voltage	≤ 125 V AC / 110 V DC (safe area) ≤ 32 V AC / 32 V DC (Zone 2)
Continuous current	≤ 0.5 A AC / 0.3 A DC (safe zone), ≤ 0.5 A AC / 1 A DC (Zone 2)

General data	
Supply voltage	19.2 - 31.2 V DC
Power consumption	≤ 3 W (2 channels)
Tightening torque, min. / Tightening torque, max.	0.4 Nm / 0.6 Nm
Ambient temperature / Storage temperature	/ -20 °C...60 °C / -20 °C...85 °C

Power rating	
Power rating	≤ 62.5 VA / 32 W (safe area) ≤ 16 VA / 32 W (Zone 2)

Approvals	
Approvals	cULus; DETNORVER; EAC; FMEX; GOSTEX; GOSTME25; IECEXKEM; KEMAATEX

Insulation coordination	
Insulation voltage	2.6 kV (input / output)
Rated voltage	300 V
EMC standards	DIN EN 61326, NE 21

Dimensions	
Clamping range (nominal / min. / max.)	mm ²
Length x width x height	mm

Screw connection, Removable terminal block	
Clamping range (nominal / min. / max.)	2.5/0.5/2.5
Length x width x height	22.5/117.2

Note	

Ordering data		
Type	Qty.	Order No.
1-channel version		
ACT20X-HTI-SA0-S	1	8965470000
2-channel version		
ACT20X-2HTI-2SA0-S	1	8965480000

CBX200 USB configuration adapter - 8978580000	

Dimensions	
Clamping range (nominal / min. / max.)	mm ²
Length x width x height	mm

Screw connection, Removable terminal block	
Clamping range (nominal / min. / max.)	2.5/0.5/2.5
Length x width x height	22.5/117.2

Note	

Ordering data		
Type	Qty.	Order No.
1-channel version		
ACT20X-HTI-SA0-S	1	8965470000
2-channel version		
ACT20X-2HTI-2SA0-S	1	8965480000

CBX200 USB configuration adapter - 8978580000	

Dimensions	
Clamping range (nominal / min. / max.)	mm ²
Length x width x height	mm

Screw connection, Removable terminal block	
Clamping range (nominal / min. / max.)	2.5/0.5/2.5
Length x width x height	22.5/117.2

Note	

ACT20X

Universal measurement and signal isolator-converter

The ACT20X-HUI-SAO-S is a universal input signal isolator/converter. This model processes temperature signals from PT100 sensors and thermocouples as well as DC voltage and current signals (mA) from the hazardous area. On the output side, an isolated milliamp signal is passed to the receiver or controller in the safe area. This model also has a relay output which can be used for a process alarm or trip.

EX area Zone 0, 1, 2, 20, 21, 22

Safe area Zone 2 / FM Class 1, Division 2

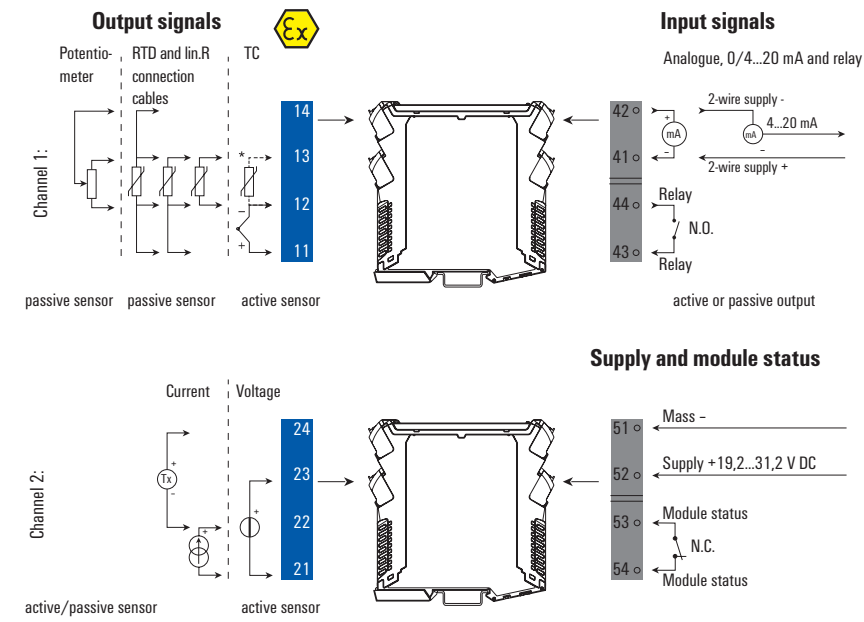

Ex label (excerpt)

ATEX	FM	U_i / U_o	30 V / 8.3 V
II 3 G Ex nA nC IIC T4	Installation in CL I DIV2 GP A-D T4	I_i / I_o	120 mA / 0.2 mA
II (1) G [Ex ia] IIC/IIA	KI. HII ABT 1/2 GP A-G or	P_i / P_o	900 mW / 0.4 mW
II (1) D [Ex iaD]	KI. I Zn2 AEx/Ex nA nC [ia] IIC T4	C_i	3 nF
IECEx	Example:	L_i	1 µH
Ex nA nC IIC T4 Gc	ATEX version,	IIC	$C_o = 7 \mu F$ $L_o = 1000 \text{ mH}$
[Ex ia Ga] IIC/IIA	Ex input External Current Source	IIA	$C_o = 73 \mu F$ $L_o = 1000 \text{ mH}$
[Ex ia a] IIC	(More details in ATEX certificate)	IIA	$C_o = 1000 \mu F$ $L_o = 1000 \text{ mH}$

Application example: position measurement of an actuator

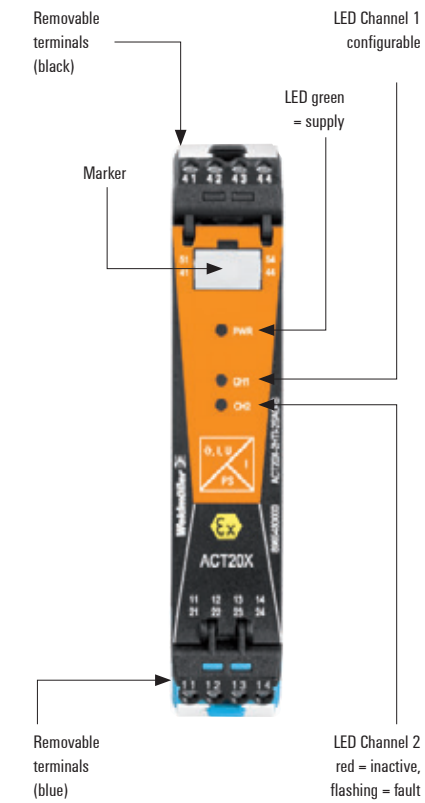
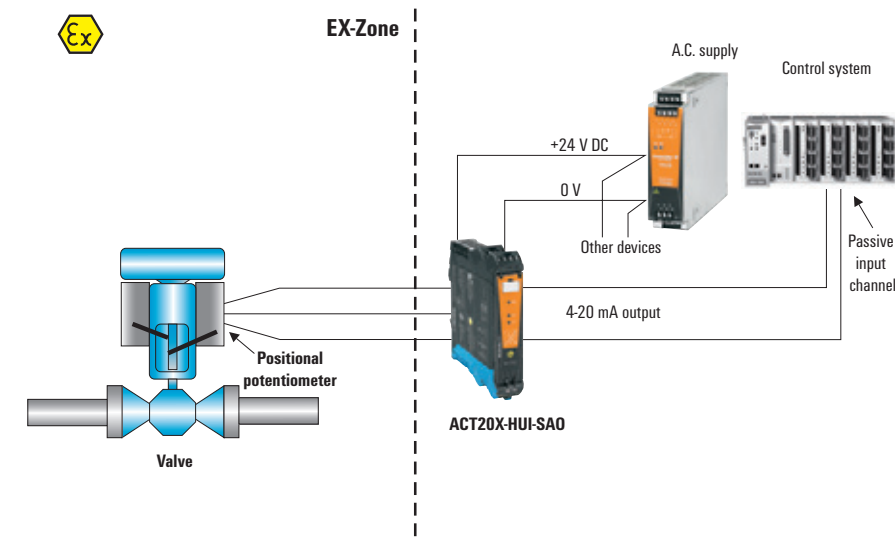

Accuracy / temperature coefficients
ACT20X-HUI-SAO

Input	Accuracy	Temperature coefficient
Input mA		
Input mA	$\leq \pm 4 \mu A$	$\leq \pm 4 \mu A / ^\circ C$
Input Volt	$\leq \pm 20 \mu V$	$\leq \pm 2 \mu V / ^\circ C$
Input RTD		
Pt100	$\leq \pm 0.2 ^\circ C$	$\leq \pm 0.02 ^\circ C / ^\circ C$
Ni100	$\leq \pm 0.3 ^\circ C$	$\leq \pm 0.03 ^\circ C / ^\circ C$
Input TC		
Type B	$\leq \pm 4.5 ^\circ C$	$\leq \pm 0.45 ^\circ C / ^\circ C$
Type E, J, K, L, N, T, U	$\leq \pm 1 ^\circ C$	$\leq \pm 0.1 ^\circ C / ^\circ C$
Type R, S, W3, W5, LR	$\leq \pm 2 ^\circ C$	$\leq \pm 0.2 ^\circ C / ^\circ C$
Note		

Intrinsically safe signal conditioners for hazardous area applications

B

Universal signal converter

- Universal isolator for intrinsically safe RTD signals, thermal sensor signals, resistor signals, potentiometer signals and DC signals (mA,V)
- PC configuration with FDT/DTM software, download at www.weidmuller.com
- Digital relay output adjustable as threshold switch
- Relay output for error alarm

ACT20X-HUI-SAO-S

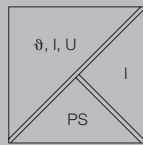

Technical data

Input

Type	intrinsically safe circuit, active (as current source) or passive (as current sink)
Sensor supply	28...16.5 V DC/0...20 mA
Temperature input range	Adjustable from -200...+800°C
Line resistance in measuring circuit	≤ 50 Ω
Input current	0...20 mA, 4...20mA, ± 25 mA
Input voltage	0...12 V DC, configurable: 0..1 / 0.2...1 / 0..5 / 0...10 and 2...10 V DC
Potentiometer	10 Ω...10 kΩ
Input resistance, voltage/current	> 10 MΩ @ 600 mV, 2 MΩ @ 28 V / 20 Ω + PTC 50 Ω

Output analogue

Output current	0...23 mA, configurable: 0...20 / 4...20 / 20...0 / 20...4 mA, configurable downscale (3.5 mA) / upscale (23 mA) @ error
Output signal limit	3.8...20.5 mA / 0...20.5 mA (dependent on range)
load impedance current	≤ 600 Ω
Influence of load resistance	≤ 0.01% of span / 100 Ω

Current loop output

Output current (current loop)	4...20 mA
Load resistance	≤ (Vs - 10) / 20 mA (current loop)
Influence of load resistance	≤ 0.01% of span / 100 Ω
2-wire supply	≤ 26 V DC

Output digital

Type	Relay, 1 NO / NC contact
Function	Configurable switching thresholds, Sensor error, Window function
Nominal switching voltage	≤ 250 V AC / 30 V DC (safe area) ≤ 32 V AC / 32 V DC (Zone 2)
Continuous current	≤ 2 A AC/DC (safe area, Zone 2 area)

Alarm output

Type	Relay, 1 NC (voltage-free)
Nominal switching voltage	≤ 125 V AC / 110 V DC (safe area) ≤ 32 V AC / 32 V DC (Zone 2)
Continuous current	≤ 0.5 A AC / 0.3 A DC (safe zone), ≤ 0.5 A AC / 1 A DC (Zone 2)

General data

Supply voltage	19.2 - 31.2 V DC
Power consumption	≤ 3.5 W
Tightening torque, min. / Tightening torque, max.	0.4 Nm / 0.6 Nm
Ambient temperature / Storage temperature	/ -20 °C...60 °C / -20 °C...85 °C

Approvals

Approvals	cULus; DETNORVER; EAC; FMEX; GOSTEX; GOSTME25; IECEXKEM; KEMAATEX
-----------	---

Insulation coordination

Insulation voltage / Rated voltage	2.6 kV (input / output) / 300 V
EMC standards	DIN EN 61326, NE 21

Dimensions

Clamping range (nominal / min. / max.)	mm ²
Length x width x height	mm

Note

Screw connection, Removable terminal block

Clamping range (nominal / min. / max.)	mm ²
Length x width x height	mm

Technical data

Type	intrinsically safe circuit, active (as current source) or passive (as current sink)
Sensor supply	28...16.5 V DC/0...20 mA
Temperature input range	Adjustable from -200...+800°C
Line resistance in measuring circuit	≤ 50 Ω
Input current	0...20 mA, 4...20mA, ± 25 mA
Input voltage	0...12 V DC, configurable: 0..1 / 0.2...1 / 0..5 / 0...10 and 2...10 V DC
Potentiometer	10 Ω...10 kΩ
Input resistance, voltage/current	> 10 MΩ @ 600 mV, 2 MΩ @ 28 V / 20 Ω + PTC 50 Ω

Output analogue

Output current	0...23 mA, configurable: 0...20 / 4...20 / 20...0 / 20...4 mA, configurable downscale (3.5 mA) / upscale (23 mA) @ error
Output signal limit	3.8...20.5 mA / 0...20.5 mA (dependent on range)
load impedance current	≤ 600 Ω
Influence of load resistance	≤ 0.01% of span / 100 Ω

Current loop output

Output current (current loop)	4...20 mA
Load resistance	≤ (Vs - 10) / 20 mA (current loop)
Influence of load resistance	≤ 0.01% of span / 100 Ω
2-wire supply	≤ 26 V DC

Output digital

Type	Relay, 1 NO / NC contact
Function	Configurable switching thresholds, Sensor error, Window function
Nominal switching voltage	≤ 250 V AC / 30 V DC (safe area) ≤ 32 V AC / 32 V DC (Zone 2)
Continuous current	≤ 2 A AC/DC (safe area, Zone 2 area)

Alarm output

Type	Relay, 1 NC (voltage-free)
Nominal switching voltage	≤ 125 V AC / 110 V DC (safe area) ≤ 32 V AC / 32 V DC (Zone 2)
Continuous current	≤ 0.5 A AC / 0.3 A DC (safe zone), ≤ 0.5 A AC / 1 A DC (Zone 2)

General data

Supply voltage	19.2 - 31.2 V DC
Power consumption	≤ 3.5 W
Tightening torque, min. / Tightening torque, max.	0.4 Nm / 0.6 Nm
Ambient temperature / Storage temperature	/ -20 °C...60 °C / -20 °C...85 °C

Approvals

Approvals	cULus; DETNORVER; EAC; FMEX; GOSTEX; GOSTME25; IECEXKEM; KEMAATEX
-----------	---

Insulation coordination

Insulation voltage / Rated voltage	2.6 kV (input / output) / 300 V
EMC standards	DIN EN 61326, NE 21

Dimensions

Clamping range (nominal / min. / max.)	mm ²
Length x width x height	mm

Note

Usable as:

- Safety barrier (insulator)
- Signal conversion
- 2-wire measuring transducer
- Amplifier, repeater

Technical data

Type	Temperature-range	Accuracy
Metal PTC		
Pt100	-200...850 °C	± (0.15 + 0.02 x T) Class A
Pt500	-200...850 °C	± (0.30 °C + 0.005 x T) Class B
Pt1000	-200...850 °C	
Ni50		
Ni100	-60...0 °C	± (0.4 + 0.007 x T)
Ni120	0...180 °C	± (0.4 + 0.028 x T)
Ni1000		
TC-Type according to IEC60584-1		
B	50...250 °C	± 25 K
	250...500 °C	± 10 K
	500...1820 °C	± 6 K
E	-200...-150 °C	± 4 K
	-150...1000 °C	± 3 K
J	-200...-150 °C	± 4 K
	-150...1200 °C	± 3 K
K	-200...-150 °C	± 5 K
	-150...1200 °C	± 3 K
	1200...1372 °C	± 4 K
N	-200...-150 °C	± 6 K
	-150...1300 °C	± 3 K
R	-50...200 °C	± 10 K
	200...1780 °C	± 6 K
S	-50...200 °C	± 10 K
	200...1780 °C	± 6 K
T	-200...-150 °C	± 5 K
	-150...400 °C	± 3 K
according to DIN43710		
U	0...600 °C	± 3 °C
L	0...900 °C	± 3 °C

Ordering data

Type	Qty.	Order No.
1-channel version		
ACT20X-HUI-SAO-S	1	8965490000

CBX200 USB configuration adapter - 8978580000

ACT20X

Output loop powered universal measurement and signal isolating converter

The ACT20X-HUI-SA0-LP is a universal input, isolating signal converter. This model processes temperature signals from PT100 sensors and thermocouples as well as DC voltage and current signals (mA) from the hazardous area. The 12.5 mm wide module is powered through its 4-20 mA output.

EX area Zone 0, 1, 2, 20, 21, 22

Safe area Zone 2 / FM Class 1, Division 2

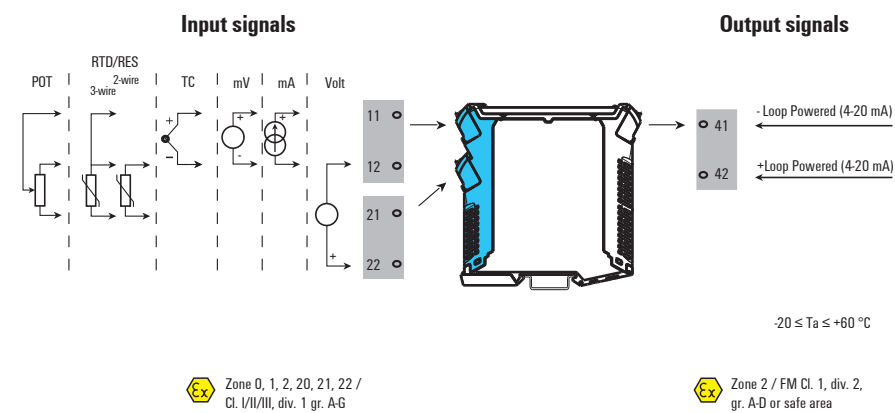

Ex label

ATEX	U_o	5.88 V
II 3 G Ex nA nC IIC T4	I_o	3.1 mA
II (1) G [Ex ia] IIC/II B/II A	P_o	4.6 mW
II (1) D [Ex ia D]	C_i	0.001 μF
IECEx	L_i	negligible
Ex nA IIC T4 Gc	Example:	
[Ex ia Ma Ga] I/II C [Ex ia Da] IIIC	IECEx version	
	(More details in IECEx certificate)	

Application example: Temperature measurement in the EX-zone

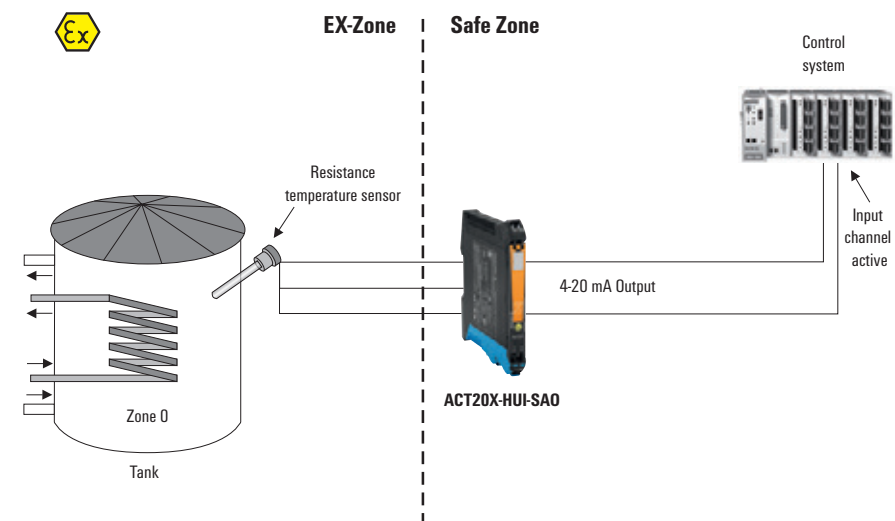

Accuracy / temperature coefficients ACT20X-HUI-SA0-LP

Input	Accuracy	Temperature coefficient
Input mA	$\leq \pm 4 \mu\text{A}$	$\leq \pm 4 \mu\text{A} / ^\circ\text{C}$
Input Volt	$\leq \pm 20 \mu\text{V}$	$\leq \pm 2 \mu\text{V} / ^\circ\text{C}$
Input RTD		
Pt100	$\leq \pm 0.2 \text{ }^\circ\text{C}$	$\leq \pm 0.02 \text{ }^\circ\text{C} / ^\circ\text{C}$
Ni100	$\leq \pm 0.3 \text{ }^\circ\text{C}$	$\leq \pm 0.03 \text{ }^\circ\text{C} / ^\circ\text{C}$
Input TC		
Type B	$\leq \pm 4.5 \text{ }^\circ\text{C}$	$\leq \pm 0.45 \text{ }^\circ\text{C} / ^\circ\text{C}$
Type E, J, K, L, N, T, U	$\leq \pm 1 \text{ }^\circ\text{C}$	$\leq \pm 0.1 \text{ }^\circ\text{C} / ^\circ\text{C}$
Type R, S, W3, W5, LR	$\leq \pm 2 \text{ }^\circ\text{C}$	$\leq \pm 0.2 \text{ }^\circ\text{C} / ^\circ\text{C}$
Note		

Intrinsically safe signal conditioners for hazardous area applications

B

Universal measurement and signal isolator-converter

Output-loop powered

- Universal isolator for intrinsically safe RTD signals, thermal sensor signals, resistor signals, potentiometer signals and DC signals (mA,V)
- Supply via output loop
- 12.5 mm thin housing
- PC configuration with FDT/DTM software, download at www.weidmueller.com

ACT20X-HUI-SAO-LP-S

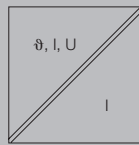

Technical data

Input

Type
intrinsically safe circuit
Temperature input range
Adjustable from -200...+800°C
Input current
configurable, ± 25 mA, 0...20 mA, 4...20mA
Input voltage
configurable, ± 12 V DC (min. measurement range 1 V), ± 28 V DC (min. measurement range 2 V), ± 600 mV DC (min. measurement range 50 mV), ± 150 mV DC (min. measurement range 15 mV)

Potentiometer
Input resistance, voltage/current
10 Ω...10 kΩ
> 10 MΩ @ 600 mV, 2 MΩ @ 28 V / 70 Ω

Output analogue

Output current
4...20 mA (max. 23 mA)
load impedance current
≤ 700 Ω
Residual ripple (current loop)
≤ 10 mV_{eff}
Accuracy
< 0.1 % of end value
Temperature coefficient
< 0.02 °C of measuring range / °C
Step response time
< 400 ms (10...90 %)
Cut-off frequency (-3 dB)
100 Hz

General data

Supply voltage
via output current loop, 11...28 V DC (loop powered)
Tightening torque, min. / Tightening torque, max.
0.4 Nm / 0.6 Nm
Ambient temperature / Storage temperature
/ 0 °C...60 °C / -20 °C...70 °C

Approvals

Approvals
CE, EAC, GOSTEX

Insulation coordination

Insulation voltage / Rated voltage
3.51 kV between input and output / 300 V_{eff}
Rated voltage
300 V_{eff}
Standards
DIN EN 61326-1, IEC 61010-1, IEC 61010-2-030, IEC 60079-0, IEC 60079-11, IEC 60079-15, IEC 60079-26
Impulse withstand voltage
4 kV (1.2/50 μs)
Overvoltage category
III
Pollution degree
2

Inputs

Type
Thermocouples (TC), RTD, mA, Volt, mV, resistor, potentiometer

Type	Standard	Lower limit	Upper limit	Min. area
B	IEC584	100 °C	1820 °C	400 °C
E		-270 °C	1000 °C	
J		-270 °C	1200 °C	80 °C
K		-270 °C	1372 °C	
L	DIN43710	-100 °C	900 °C	
N		-180 °C	1300 °C	100 °C
R, S	IEC584	-50 °C	1768 °C	300 °C
T		-270 °C	400 °C	80 °C
U	DIN43710	-200 °C	600 °C	100 °C

User-defined Input
Up to 101 values

Thermocouple inputs

Error detection
Upper error signalling value:
23 mA
Lower error signalling value:
3.5 mA

mA
±25 mA @ 70 Ω
4 mA
±28 V @ 2 MΩ
2,0 V
±12 V @ 2 MΩ
1,0 V

2-, 3-, 4-wire RTD

Type	Standard	Lower limit	Upper limit	Min. area
Pt100, Pt200	DIN43710	-200 °C	850 °C	-20 °C
Pt1000		-80 °C	320 °C	15 °C
Ni120		-100 °C	260 °C	100 °C
Cu10		-100 °C	260 °C	100 °C

User-defined Input
Up to 101 values

Resistance
0 to 12 kΩ
500 Ω
0 to 15 kΩ
100 Ω
0 to 750 Ω
50 Ω

Potentiometer
1.2 kΩ to 500 kΩ

Dimensions

Clamping range (nominal / min. / max.)
mm²
Depth/Width/Height
Note

Screw connection, Removable terminal block

2.5/0.5/2.5
113.6/12.5/117.2117.2

Ordering data

Type	Qty.	Order No.
1-channel version		
ACT20X-HUI-SAO-LP-S	1	1318220000

Resistance
0 to 12 kΩ
500 Ω
0 to 15 kΩ
100 Ω
0 to 750 Ω
50 Ω

Potentiometer
1.2 kΩ to 500 kΩ

Ordering data

Type	Qty.	Order No.
1-channel version		
ACT20X-HUI-SAO-LP-S	1	1318220000

CBX200 USB configuration adapter - 8978580000

ACT20X

NAMUR isolating switching amplifier: with relay output

The ACT20X-HDI-SDO-RNO (NC) isolating switching amplifier is a specialised signal isolating converter for NAMUR sensor signals or for volt-free contacts from a Zone 0 hazardous area. A single relay, available optionally as NC or NO, provides the output signal in the safe zone. Single-channel or double-channel versions are also available.

EX area Zone 0, 1, 2, 20, 21, 22

Safe area Zone 2 / FM Class 1, Division 2

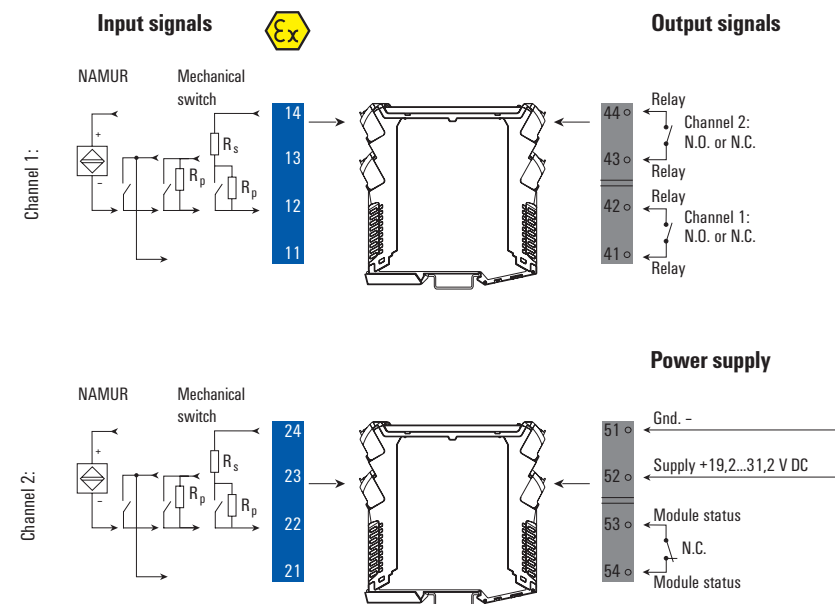

Ex label (excerpt)

ATEX	FM	U_s	10.6 V
II 3 G Ex nA nC IIC T4	Installation in CL I DIV2 GP A-D T4	I_s	12 mA
II (1) G [Ex ia Ga] IIC/IIB/IIA	KI. HII ABT 1/2 GP A-G oder	P_o	32 mW
II (1) D [Ex iaD]	KI. I Zn2 AEx/Ex nA nC [ia] IIC T4	L_s / R_s	1150 μ H/ Ω
IECEx	Example:	IIC	$C_s = 2 \mu$ F, $L_s = 260$ mH
Ex nA nC IIC T4 Gc	ATEX version,	IIB	$C_s = 6 \mu$ F, $L_s = 780$ mH
[Ex ia Ga] IIC/IIB/IIA	Ex input	IIA	$C_s = 18 \mu$ F, $L_s = 1000$ mH
[Ex ia Da] IIC	(More details in ATEX certificate)		

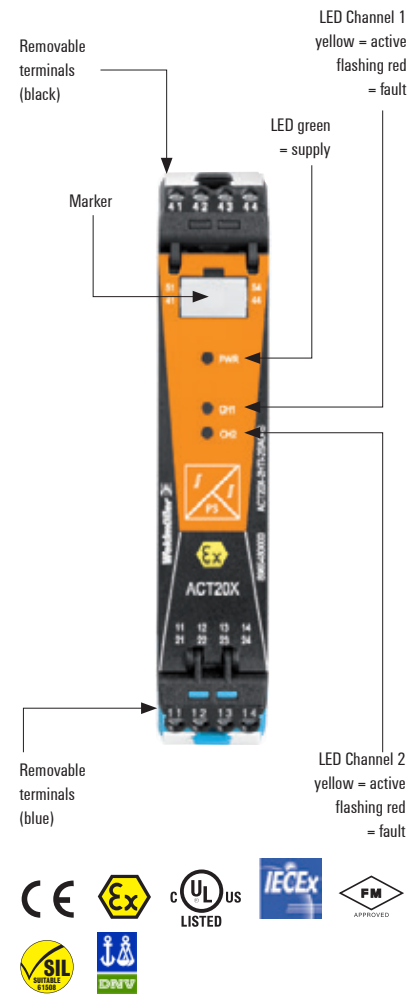

Application: monitoring of fill level with the ACT20X HDI-SDO-RNO (relay output)

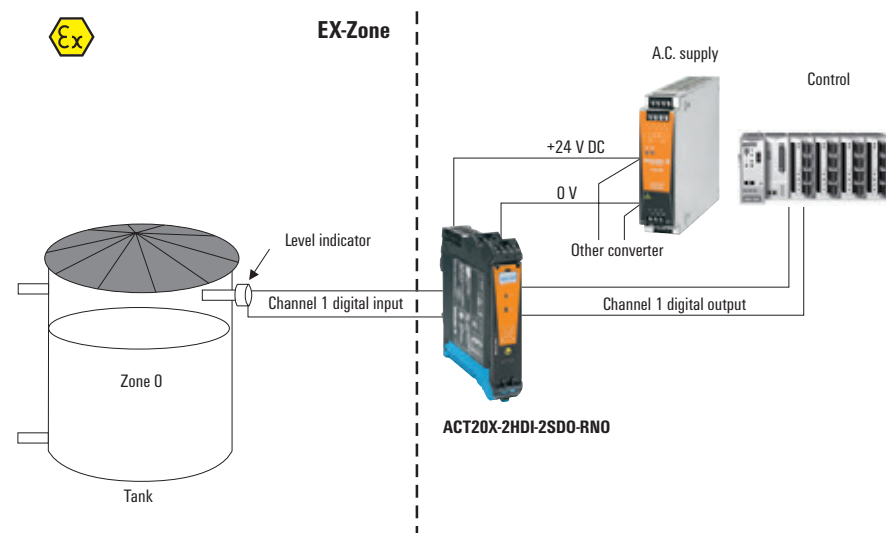

Intrinsically safe signal conditioners for hazardous area applications

B

NAMUR isolating switching amplifier

- Converts intrinsically safe digital signals (NAMUR / switching contact) from EX Zone 0 into digital output signals (relay output) for the safe zone
- PC configuration with FDT/DTM software, download at www.weidmueller.com
- Relay output for error alarm, cable break, short-circuit
- 1 or 2 channels in one module

**ACT20X-HDI-SDO-RNO-S / RNC-S
ACT20X-2HDI-2SDO-RNO-S / RNC-S**

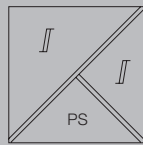

Technical data

Input	
Sensor	NAMUR sensor, according to EN60947, switch with or without RS, RP
Sensor supply	8 V DC / 8 mA
Resistance	RP = 750 Ω / RS = 15kΩ
Input frequency	0..5 kHz
Pulse duration	> 0.1 ms
Input resistance	1 kΩ
Trigger level low / Trigger level high	< 1.2 mA / > 2.1 mA
Output signal in case of wire break	< 0.1 mA, > 6.5 mA (in case of wire break)
Output	
Type	Relay, 2 NC (voltage-free), Switching frequency 20 Hz, digital, output = input, direct or inverse (configurable)
Rated switching voltage	≤ 250 V AC / 30 V DC (safe area) ≤ 32 V AC / 32 V DC (Zone 2)
Continuous current	≤ 2 A AC/DC (safe area, Zone 2 area)
Power rating	≤ 500 VA / 60 W (safe area) ≤ 16 VA / 32 W (Zone 2)
Alarm output	
Type	Relay, 1 NC (voltage-free)
Nominal switching voltage	≤ 125 V AC / 110 V DC (safe area) ≤ 32 V AC / 32 V DC (Zone 2)
Continuous current	≤ 0.5 A AC / 0.3 A DC (safe zone), ≤ 0.5 A AC / 1 A DC (Zone 2)
Power rating	≤ 62.5 VA / 32 W (safe area) ≤ 16 VA / 32 W (Zone 2)
General data	
Supply voltage	19.2 – 31.2 V DC
NAMUR supply	8 V DC / 8 mA
Power consumption	≤ 3 W (2 channels)
Tightening torque, min. / Tightening torque, max.	0.4 Nm / 0.6 Nm
Ambient temperature / Storage temperature	/ -20 °C..60 °C / -20 °C..85 °C
Approvals	
Approvals	cULus; DETNORVER; EAC; FMEX; GOSTEX; GOSTME25; IECEXKEM; KEMAATEX
Insulation coordination	
Insulation voltage	2.6 kV (input / output)
Rated voltage	300 V
EMC standards	DIN EN 61326, NE 21

Dimensions	
Clamping range (nominal / min. / max.)	mm ²
Length x width x height	mm
Note	

Screw connection, Removable terminal block	
	2.5/0.5/2.5
	22.5/117.2

Ordering data

Type	Qty.	Order No.
1-channel version, NC		
ACT20X-HDI-SDO-RNC-S	1	8965350000
1-channel version, NO		
ACT20X-HDI-SDO-RNO-S	1	8965340000
2-channel version, NC		
ACT20X-2HDI-2SDO-RNC-S	1	8965380000
2-channel version, NO		
ACT20X-2HDI-2SDO-RNO-S	1	8965370000
CBX200 USB configuration adapter - 8978580000		

ACT20X

Pulse Isolator, with NPN transistor output.

The ACT20X-HDI-SDO isolating switching amplifier is a digital pulse signal isolator for Namur sensors or volt-free contacts from a Zone 0 hazardous area. A transistor (NPN) output is provided for the receiver or controller in the safe area. Single-channel or double-channel versions are also available.

EX area Zone 0, 1, 2, 20, 21, 22

Safe area Zone 2 / FM Class 1, Division 2

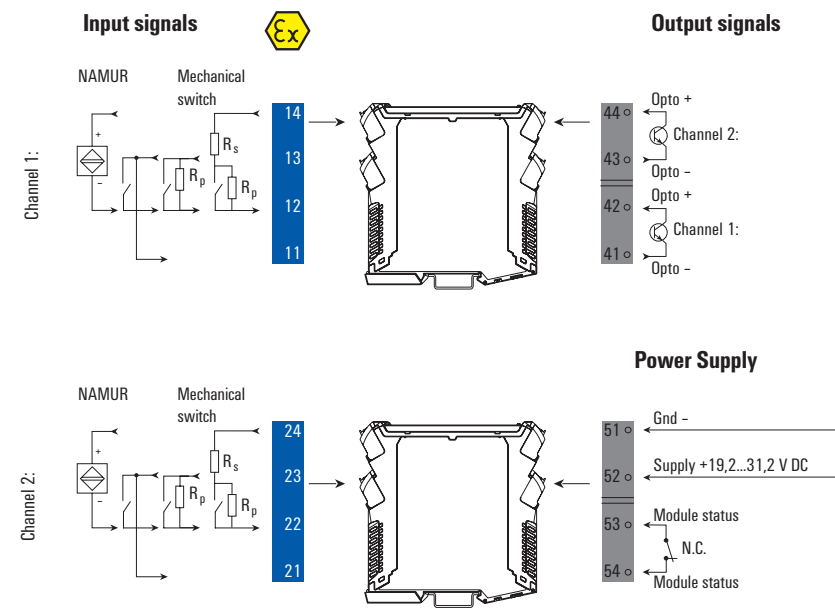

Ex label (excerpt)

ATEX	FM	U_o	10.6 V
II 3 G Ex nA nC IIC T4	Installation in CL I DIV2 GP A-D T4	I_o	12 mA
II (1) G [Ex ia Ga] IIC/IIB/IIA	KI. HII ABT 1/2 GP A-G oder	P_o	32 mW
II (1) D [Ex iaD]	KI. I Zn2 AEx/Ex nA nC [ia] IIC T4	L_o / R_o	1150 μ H/ Ω
IECEx	Example:	IIC	$C_o = 2 \mu$ F, $L_o = 260$ mH
Ex nA nC IIC T4 Gc	ATEX version	IIB	$C_o = 6 \mu$ F, $L_o = 780$ mH
[Ex ia Ga] IIC/IIB/IIA	Ex input	IIA	$C_o = 18 \mu$ F, $L_o = 1000$ mH
[Ex ia Da] IIC	(More details in ATEX certificate)		

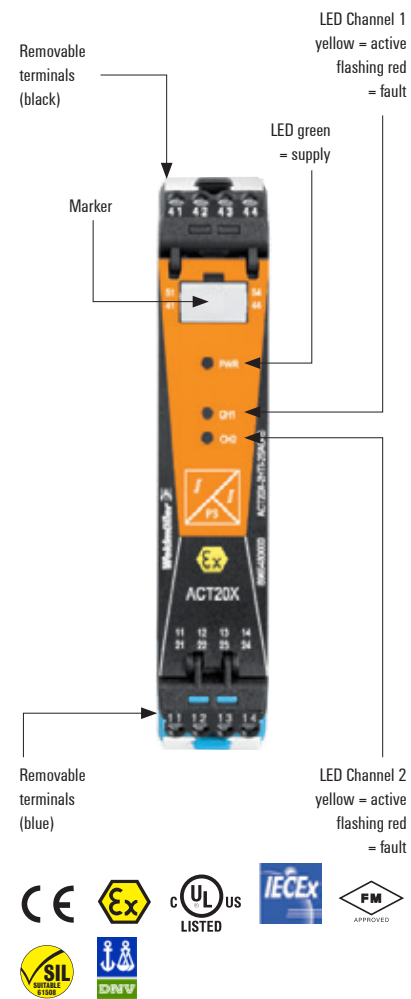

Application: monitoring the fill level with isolating switching amplifier

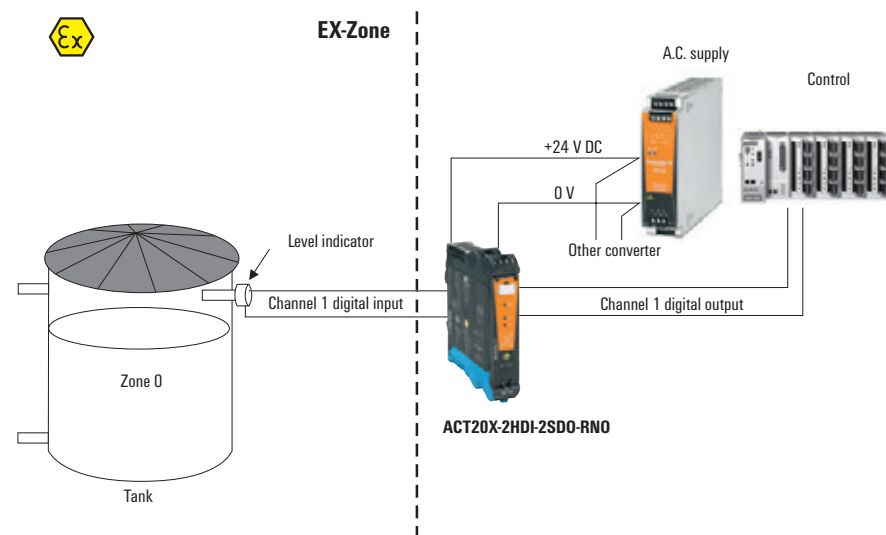

NAMUR isolating switching amplifier

- Converts intrinsically safe signals (NAMUR / switching contact) from EX Zone 0 into digital output signals (relay output) for the safe zone
- PC configuration with FDT/DTM software, download at www.weidmuller.com
- Relay output for error alarm
- 1 or 2 channels in one module

ACT20X-HDI-SD0-S / 2HDI-2SD0-S

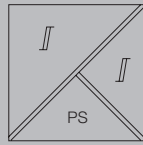

Technical data

Input	
Sensor	NAMUR sensor, according to EN60947, switch with or without RS, RP
Sensor supply	8 V DC / 8 mA
Resistance	Parallel resistor 15kΩ, Series resistor 750Ω
Input frequency	0...5 kHz
Pulse duration	> 0.1 ms
Input resistance	1 kΩ
Trigger level low / Trigger level high	< 1.2 mA / > 2.1 mA
Output signal in case of wire break	< 0.1 mA, > 6.5 mA (in case of wire break)
Output	
Type	NPN transistor output, digital, output = input, direct or inverse (configurable)
Switching frequency	5 kHz
Pulse duration	> 0.1 ms
Rated switching voltage	≤ 30 V DC
Power rating	≤ 80 mA / ≤ 2.4 W
Voltage drop at max. load	< 2.5 V DC
Alarm output	
Type	Relay, 1 NC (voltage-free)
Nominal switching voltage	≤ 125 V AC / 110 V DC (safe area) ≤ 32 V AC / 32 V DC (Zone 2)
Continuous current	≤ 0.5 A AC / 0.3 A DC (safe zone), ≤ 0.5 A AC / 1 A DC (Zone 2)
Power rating	≤ 62.5 VA / 32 W (safe area) ≤ 16 VA / 32 W (Zone 2)
General data	
Power consumption	≤ 3 W (2 channels)
Supply voltage	19.2 - 31.2 V DC
NAMUR supply	8 V DC / 8 mA
Power consumption	≤ 3 W (2 channels)
Tightening torque, min. / Tightening torque, max.	0.4 Nm / 0.6 Nm
Ambient temperature / Storage temperature	/ -20 °C...60 °C / -20 °C...85 °C
Approvals	
Approvals	cULus; DETNORVER; EAC; FMEX; GOSTEX; GOSTME25; IECEXKEM; KEMAATEX
Insulation coordination	
Insulation voltage	2.6 kV (input / output)
Rated voltage	300 V
EMC standards	DIN EN 61326, NE 21

Dimensions		Screw connection, Removable terminal block	
Clamping range (nominal / min. / max.)	mm ²	2.5/0.5/2.5	
Length x width x height	mm	22.5/117.2	
Note			

Ordering data

Type	Qty.	Order No.
1-channel version		
ACT20X-HDI-SD0-S	1	8965360000
2-channel version		
ACT20X-2HDI-2SD0-S	1	8965390000

CBX200 USB configuration adapter - 8978580000

ACT20X

Valve control component for gas group IIC, 35 mA

The ACT20X-SDI-HAO-S solenoid/actuator driver takes a switched input from e.g. a safe area controller and delivers an corresponding output to operate an actuator in a hazardous area, e.g. Zone 0. It is available in a single-channel or double-channel version.

EX area Zone 0, 1, 2, 20, 21, 22

Save area Zone 2 / FM KI. 1 Abt. 2

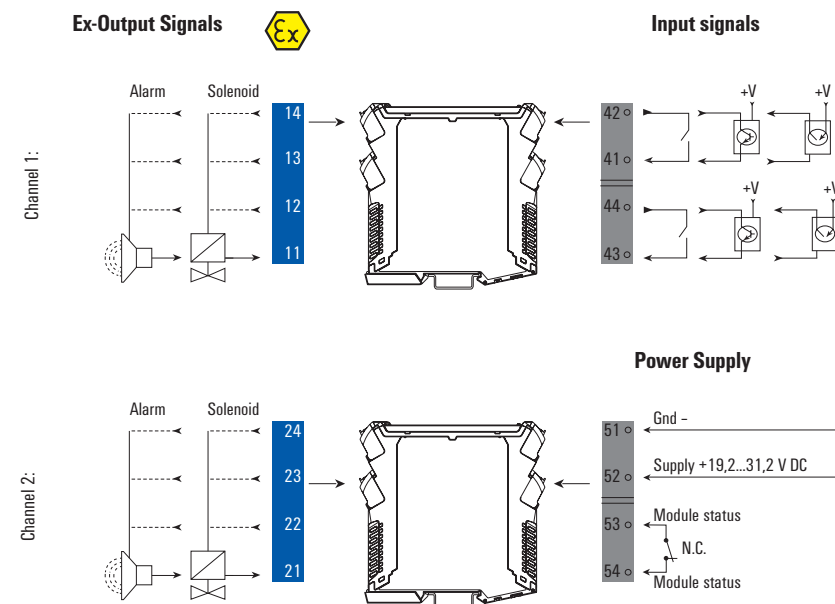

Ex label (excerpt)

ATEX	FM	U _o	28 V
II 3 G Ex nA nC IIC T4	Installation in CL I DIV2 GP A-D T4	I _e	100 mA
II (1) G [Ex ia Ga] IIC/IIA/IIA	KI. HII ABT 1/2 GP A-G oder	P _o	0.70 mW
II (1) D [Ex iaD]	KI. I Zn2 AEx/Ex nA nC [ia] IIC T4	IIC	C _o = 0.08 µF, L _o = 2.9 mH
IECEx	Example:	IIB	C _o = 0.64 µF, L _o = 12.8 mH
Ex nA nC IIC T4 Gc	ATEX version	IIA	C _o = 2.1 µF, L _o = 22.8 mH
[Ex ia Ga] IIC/IIA/IIA	Ex Output Terminal (11-14)		
[Ex ia Da] IIC	(More details in ATEX certificate)		



Application: Inflow control in Ex zone with gas group IIC

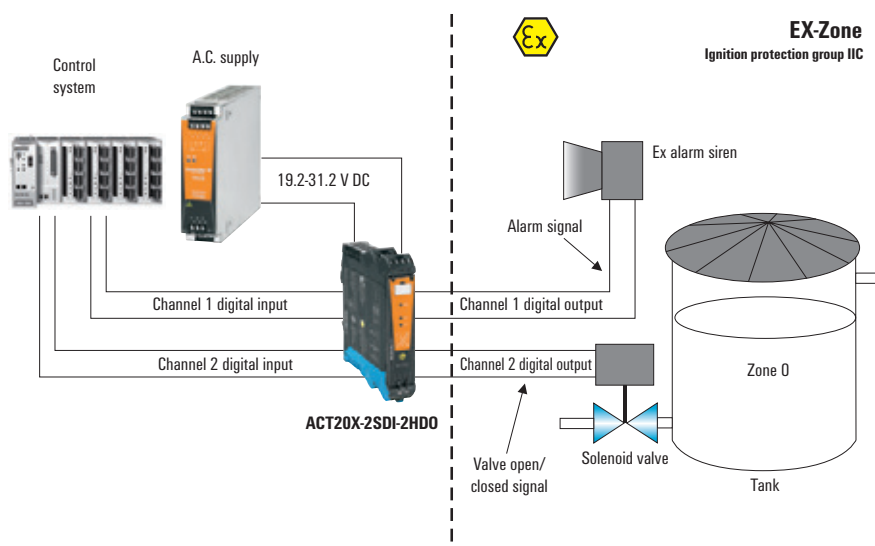

Output data For gas group IIC (≤ 35 mA)

Connection terminal	U without load	U with load	I max
Channel 1			
11-12	Min. 24 V	Min. 12.5 V	35 mA
11-13	Min. 24 V	Min. 13.5 V	35 mA
11-14	Min. 24 V	Min. 14.5 V	35 mA
Note			

For gas group IIC (≤ 35 mA)

Connection terminal	U without load	U with load	I max
Channel 2			
21-22	Min. 24 V	Min. 12.5 V	35 mA
21-23	Min. 24 V	Min. 13.5 V	35 mA
21-24	Min. 24 V	Min. 14.5 V	35 mA
Note			

ACT20X

Intrinsically safe signal conditioners for hazardous area applications

B

Valve control module

- Valve control component for control of intrinsically safe valves, LEDs, acoustic alarms, etc.
- PC configuration with FDT/DTM software, download at www.weidmueller.com
- Output current is limited to 35 mA for ignition group IIC
- 1 or 2 channels in one module
- Relay output for error alarm

ACT20X-SDI-HDO / 2SDI-2HDO

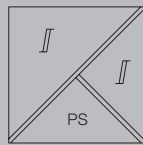

Technical data

Input	
Type	NPN, PNP switching signal
Input voltage	≤ 28 V DC
Input resistance, voltage	3.5 kΩ
Trigger level low	≤ 2.0 V DC (NPN), ≤ 8.0 V DC (PNP)
Trigger level high	≥ 4.0 V DC (NPN), ≥ 10V DC (PNP)
Alarm output	
Type	Relay, 1 NC (voltage-free)
Nominal switching voltage	≤ 125 V AC / 110 V DC (safe area) ≤ 32 V AC / 32 V DC (Zone 2)
Continuous current	≤ 0.5 A AC / 0.3 A DC (safe zone), ≤ 0.5 A AC / 1 A DC (Zone 2)
Power rating	≤ 62.5 VA / 32 W (safe area) ≤ 16 VA / 32 W (Zone 2)
General data	
Supply voltage	19.2 - 31.2 V DC
Power consumption	≤ 3.5 W (with 2 channels)
Tightening torque, min. / Tightening torque, max.	0.4 Nm / 0.6 Nm
Ambient temperature / Storage temperature	/ -20 °C...60 °C / -20 °C...85 °C
Approvals	
Approvals	cULus; DETNORVER; EAC; FMEX; GOSTEX; GOSTME25; IECEXKEM; KEMAATEX
Insulation coordination	
Insulation voltage	2.6 kV (input / output)
Rated voltage	300 V
EMC standards	DIN EN 61326, NE 21

Dimensions	
Clamping range (nominal / min. / max.)	mm ²
Length x width x height	mm
Note	

Screw connection, Removable terminal block	
	2.5/0.5/2.5
	22.5/117.2

Ordering data

Type	Qty.	Order No.
1-channel version		
ACT20X-SDI-HDO-L-S	1	8965400000
2-channel version		
ACT20X-2SDI-2HDO-S	1	8965420000

CBX200 USB configuration adapter - 8978580000

ACT20X

Valve control component for gas group IIB, 60 mA

The ACT20X-SDI-HAO-S solenoid/actuator driver takes a switched input from e.g. a safe area controller and delivers an corresponding output to operate an actuator in a hazardous area, e.g. Zone. This driver is suitable for switching solenoid valves or alarm devices.

EX area Zone 0, 1, 2, 20, 21, 22

Safe area Zone 2 / FM Class 1, Division 2

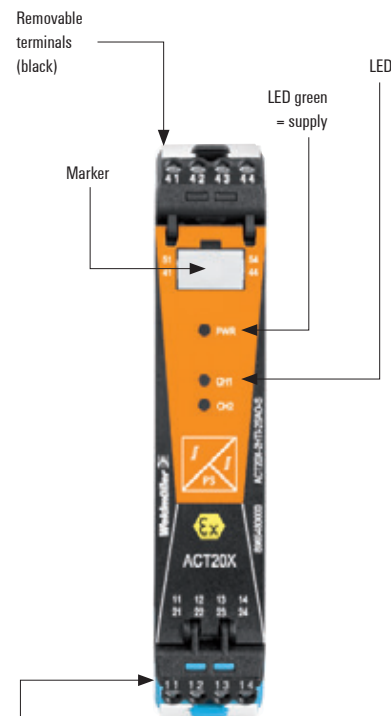
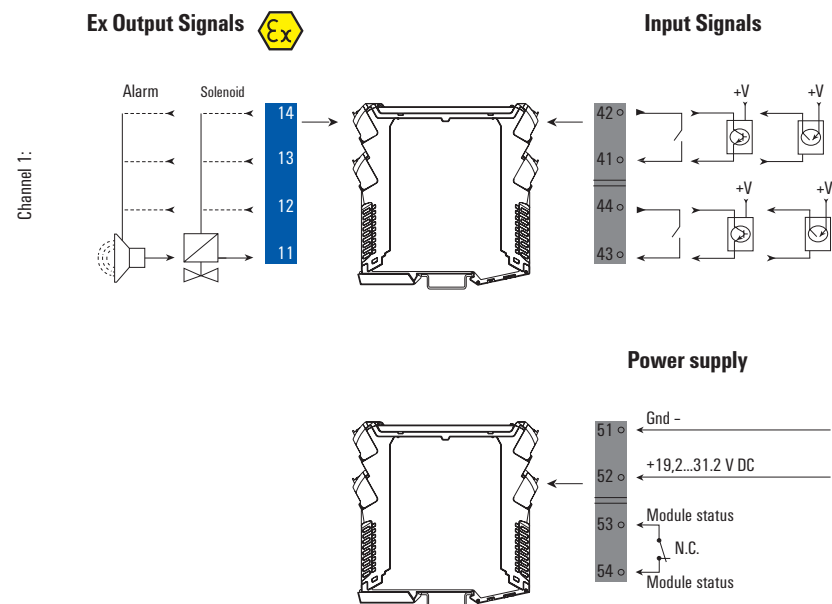

Ex label (excerpt)

ATEX	FM	U _o	28 V
II 3 G Ex nA nC IIC T4	Installation in CL I DIV2 GP A-D T4	I _e	135 mA
II (1) G [Ex ia Ga] IIC/IIB/IIA	KI. HII ABT 1/2 GP A-G oder	P _o	0.95 W
II (1) D [Ex iaD]	KI. I Zn2 AEx/Ex nA nC [ia] IIC T4	IIC	C _o = -, L _o = -
IECEx	Example:	IIB	C _o = 0.64 µF, L _o = 7.8 mH
Ex nA nC IIC T4 Gc	ATEX version,	IIA	C _o = 2.1 µF, L _o = 15.1 mH
[Ex ia Ga] IIC/IIB/IIA	Ex Output Terminal (11-14)		
[Ex ia Da] IIC	(More details in ATEX certificate)		



Application: Inflow control in Ex zone with gas group IIB

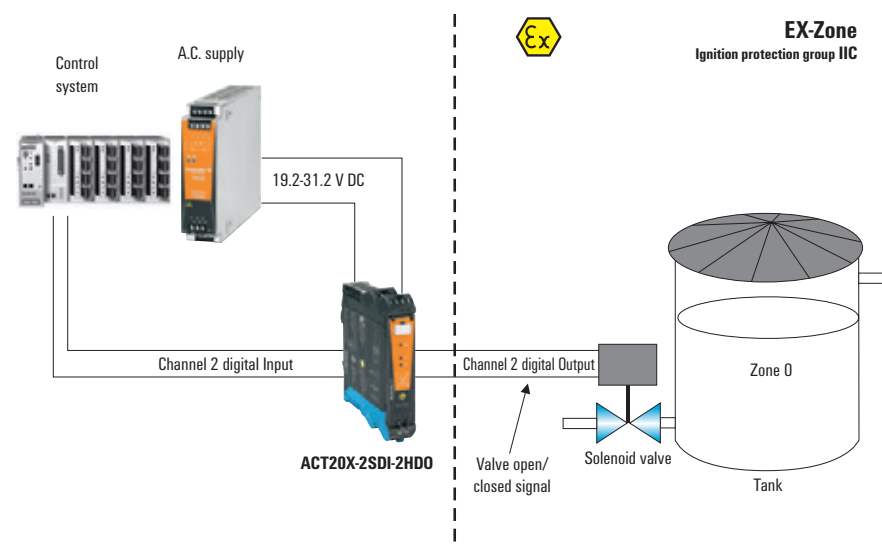

Output data For gas group IIB (≤ 60 mA)

Connection terminal	U without load	U with load	I max
Channel 1	Min. 24 V	Min. 9 V	60 mA
		Min. 11.5 V	50 mA
11-12	Min. 24 V	Min. 12.5 V	60 mA
		Min. 10 V	50 mA
11-13	Min. 24 V	Min. 11 V	60 mA
		Min. 13 V	50 mA
11-14	Min. 24 V	Min. 11 V	60 mA
		Min. 13 V	50 mA
Note			

ACT20X

Intrinsically safe signal conditioners for hazardous area applications

B

Valve control component

- Valve control component for control of intrinsically safe valves, LEDs, acoustic alarms, etc.
- PC configuration with FDT/DTM software, download at www.weidmueller.com
- Output current is limited to 35 mA for ignition group IIC
- 1 or 2 channels in one module
- Relay output for error alarm

ACT20X-SDI-HDO-H-S

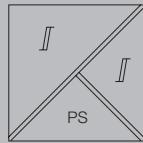

Technical data

Input	
Type	NPN, PNP switching signal
Input voltage	≤ 28 V DC
Input resistance, voltage	3.5 kΩ
Trigger level low	≤ 2.0 V DC (NPN), ≤ 8.0 V DC (PNP)
Trigger level high	≥ 4.0 V DC (NPN), ≥ 10V DC (PNP)
Alarm output	
Type	Relay, 1 NC (voltage-free)
Nominal switching voltage	≤ 125 V AC / 110 V DC (safe area) ≤ 32 V AC / 32 V DC (Zone 2)
Continuous current	≤ 0.5 A AC / 0.3 A DC (safe zone), ≤ 0.5 A AC / 1 A DC (Zone 2)
Power rating	≤ 62.5 VA / 32 W (safe area) ≤ 16 VA / 32 W (Zone 2)
General data	
Supply voltage	19.2 - 31.2 V DC
Power consumption	< 2 W
Tightening torque, min. / Tightening torque, max.	0.4 Nm / 0.6 Nm
Ambient temperature / Storage temperature	/ -20 °C...60 °C / -20 °C...85 °C
Approvals	
Approvals	cULus; DETNORVER; EAC; FMEX; GOSTEX; GOSTME25; IECXKEM; KEMAATEX
Insulation coordination	
Insulation voltage	2.6 kV (input / output)
Rated voltage	300 V
EMC standards	DIN EN 61326, NE 21

Ordering data

Type	Qty.	Order No.
1-channel version		
ACT20X-SDI-HDO-H-S	1	8965410000

CBX200 USB configuration adapter - 8978580000

Dimensions		Screw connection, Removable terminal block
Clamping range (nominal / min. / max.)	mm ²	2.5/0.5/2.5
Length x width x height	mm	22.5/117.2
Note		

Signal converters in 6 mm width

Signal converters in 6 mm width

Signal converters in 6 mm width	Universal signal converter in 6 mm width – Overview	C.2
	ACT20M – Overview	C.4
	CH20M rail bus	C.26
	MCZ-SERIES – Overview	C.30
	MCZ SERIES – DC/DC passive isolator	C.32
	MCZ-SERIES – PT100 /RTD signal converter	C.33
	MCZ-SERIES – Frequency signal converter	C.34
	MCZ-SERIES – Threshold monitoring	C.35

C

Analogue signal converter in 6 mm width

The thinnest signal converter for isolating, converting and monitoring analogue signals

The signal converters and the signal separators in the product family ACT20M, MICROSERIES and the MCZ enables the user to integrate many signal channels within a compact space. In addition to galvanic separation, these products offer the conversion and conditioning of DC and

temperature signals (TC and RTD) to standard norm signals (e.g. 4...20 mA, 0...10 V). The pluggable cross-connections option for MAS/MAZ and MCZ ranges, or the Weidmüller rail bus option for the ACT20M ensure a quick installation.

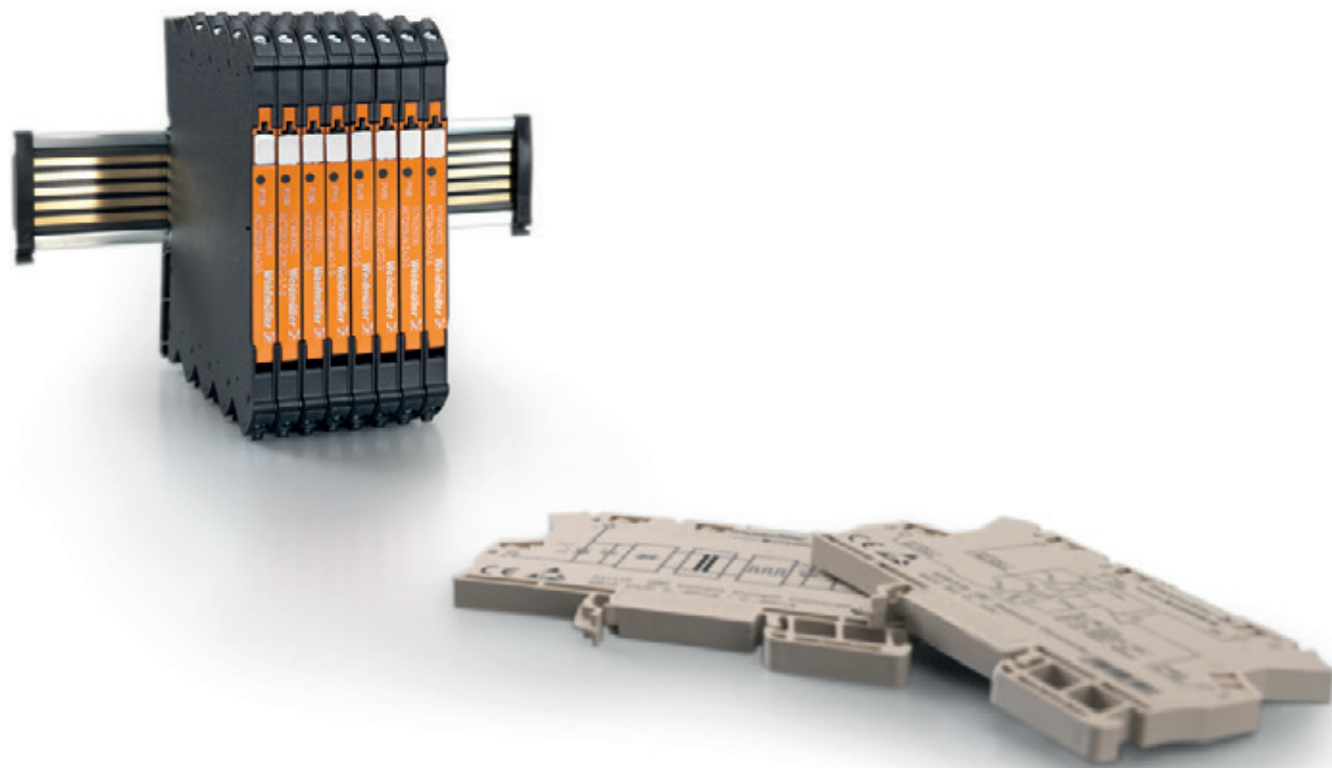

Universal signal converter in 6 mm width - Overview

Signal converters in 6 mm width

C

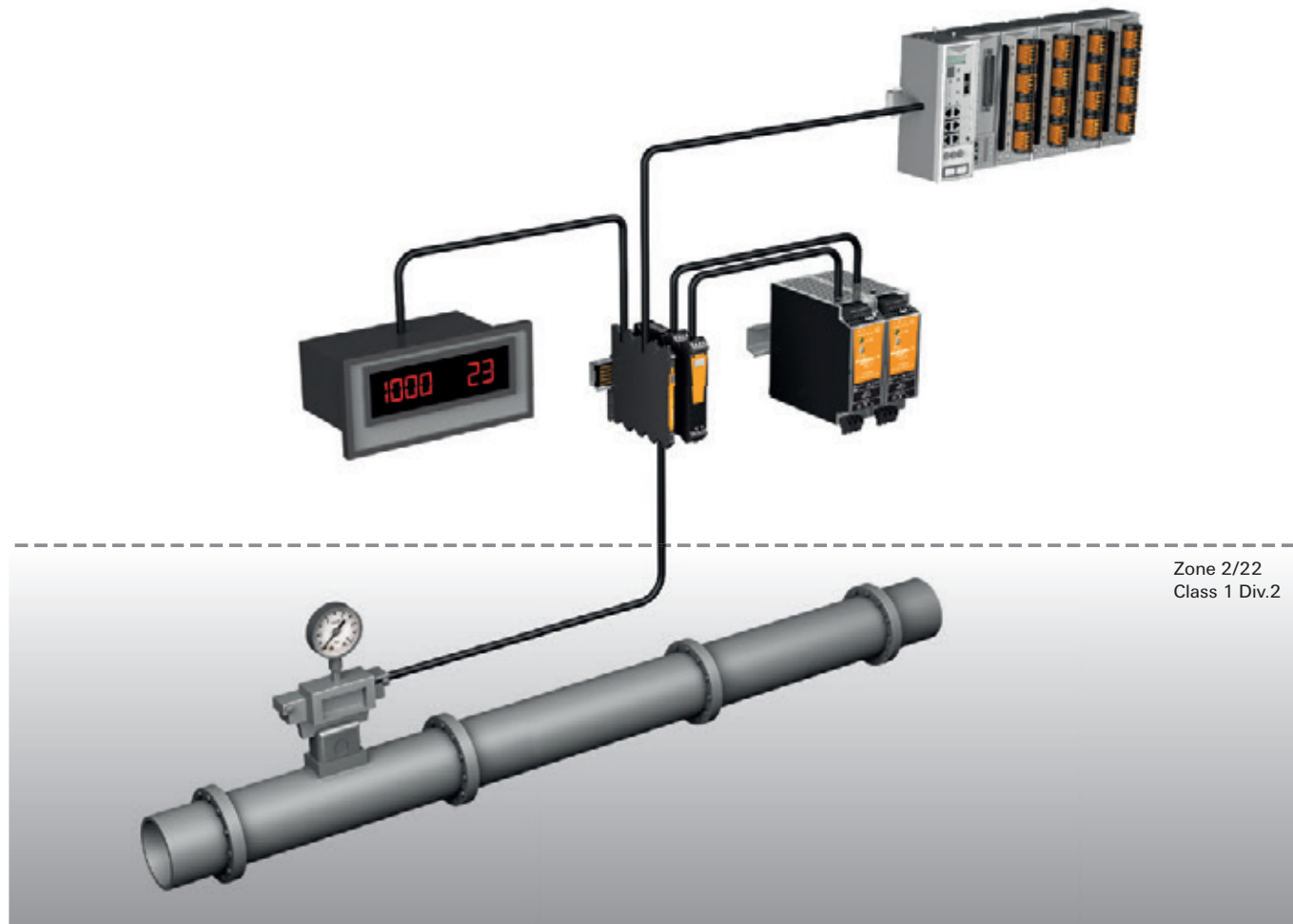

ACT20M



MCZ-SERIES

ACT20M – a narrow 6 mm signal converter

The new dimension for converting and isolating – housed in a 6 mm width

The new ACT20M range combines innovative technologies with the highest levels of functionality in an electronics housing measuring just 6 mm in width. Up to two channels per module result in space savings in the electrical cabinet. The high electrical isolation of 2.5 kV and an accuracy of up to 0.05 % both help to ensure a high degree of process reliability.

The product line consists of Input Loop Powered, Output Loop Powered and Auxiliary Powered analog isolators and converters, including a universal input converter. The eight-connection housing allows additional functionality such as 2 channel ILP, 2 channel OLP isolation and signal splitting with input powering option. The configuration is carried out via DIP switches or the FDT/ DTM software. The ACT20M modules are supplied via direct wiring or a rail bus.





The DIP switch can be configured simply on the module

In the "ACT20M Tool" software, simply select the type of input and output, and set the DIP switch configuration as displayed.



Easy configuration

DIP switches on the side are used to configure the input and output parameters, as well as the response time.

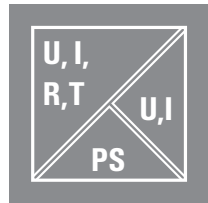

High level of galvanic isolation

2.5 kV of electrical isolation (300 V rated voltage) ensures excellent process reliability.



Installation is simple and quick

The power supply is simply snapped onto the rail bus for fast and easy installation. The supply can be through any ACT20M module or a separate power-feed unit.



Approvals

Fulfils the strict standards and requirements of the process industry. Can be used worldwide due to international and local approvals ATEX, IECEX, CULUS, FM, GL and DNV.

	Signal splitter
	Signal converter
	Universal measurement and signal converter
	Passive isolator
	Temperature transducer
	CH20M rail bus
	Power-feed modules

ACT20M – Selection table

Signal converters in 6 mm width

C

		Power supply	Function	Current				
				0 ... 20 mA 1-channel	4 ... 20 mA 1-channel	2 x 0 ... 20 mA 2-channel / splitter	2 x 4 ... 20 mA 2-channel / splitter	
Input	Current	0 ... 20 mA	24 V DC and rail bus	universal	ACT20M-UI-A0-S	ACT20M-UI-A0-S		
			U/I			ACT20M-AI-2A0-S	ACT20M-AI-2A0-S	
			Current			ACT20M-CI-2C0-S	ACT20M-CI-2C0-S	
			U/I	ACT20M-AI-A0-E-S	ACT20M-AI-A0-E-S			
			U/I	ACT20M-AI-A0-S	ACT20M-AI-A0-S			
			Current	ACT20M-CI-C0-S	ACT20M-CI-C0-S			
		U/I						
		Input Loop Powered	Current					
		Output Loop Powered	Current		ACT20M-CI-C0-OLP-S			
		Current						
		2 x 0 ... 20 mA	Output Loop Powered	Current				ACT20M-2CI-2C0-OLP-S
		Input Loop Powered	Current					
	24 V DC	Current						
	4 ... 20 mA	24 V DC and rail bus	universal	ACT20M-UI-A0-S	ACT20M-UI-A0-S			
		U/I				ACT20M-AI-2A0-S	ACT20M-AI-2A0-S	
		Current				ACT20M-CI-2C0-S	ACT20M-CI-2C0-S	
		U/I	ACT20M-AI-A0-E-S	ACT20M-AI-A0-E-S				
		U/I	ACT20M-AI-A0-S	ACT20M-AI-A0-S				
Current		ACT20M-CI-C0-S	ACT20M-CI-C0-S					
U/I								
1 x 4 ... 20 mA	Output Loop Powered	Current		ACT20M-CI-C0-OLP-S				
Current								
2 x 4 ... 20 mA	Output Loop Powered	Current				ACT20M-2CI-2C0-OLP-S		
	24 V DC	Current						
	Input Loop Powered	Current						
Current				ACT20M-2CI-2C0-ILP-S	ACT20M-2CI-2C0-ILP-S			
1 x 4 ... 20 mA	Input Loop Powered	Current						
	Current	ACT20M-CI-C0-ILP-S	ACT20M-CI-C0-ILP-S					
-10 mA...0...10 mA	24 V DC and rail bus	bipolar	ACT20M-BAI-A0-S	ACT20M-BAI-A0-S	ACT20M-BAI-2A0-S	ACT20M-BAI-2A0-S		
-20 mA...0...20 mA	24 V DC and rail bus	bipolar	ACT20M-BAI-A0-S	ACT20M-BAI-A0-S	ACT20M-BAI-2A0-S	ACT20M-BAI-2A0-S		
with sensor power supply	24 V DC and rail bus	universal	ACT20M-UI-A0-S	ACT20M-UI-A0-S				
		U/I	ACT20M-AI-A0-S	ACT20M-AI-A0-S				
Voltage	0 ... 5 V 1 ... 5 V	24 V DC and rail bus	universal	ACT20M-UI-A0-S	ACT20M-UI-A0-S			
		U/I	ACT20M-AI-A0-E-S	ACT20M-AI-A0-E-S				
		U/I	ACT20M-AI-A0-S	ACT20M-AI-A0-S				
		U/I						
	Output Loop Powered	U/I						
	0 ... 10 V 2 ... 10 V	24 V DC and rail bus	universal	ACT20M-UI-A0-S	ACT20M-UI-A0-S			
		U/I	ACT20M-AI-A0-E-S	ACT20M-AI-A0-E-S				
		U/I	ACT20M-AI-A0-S	ACT20M-AI-A0-S				
		U/I						
	Output Loop Powered	U/I						
-5 V ... 0 ... 5 V	24 V DC and rail bus	bipolar	ACT20M-BAI-A0-S	ACT20M-BAI-A0-S	ACT20M-BAI-2A0-S	ACT20M-BAI-2A0-S		
-10 V ... 0 ... 10 V	24 V DC and rail bus	bipolar	ACT20M-BAI-A0-S	ACT20M-BAI-A0-S	ACT20M-BAI-2A0-S	ACT20M-BAI-2A0-S		
		bipolar						

Note: *) available from July 2013

ACT20M - Overview

Signal converters in 6 mm width

C

Output		Voltage					
-10 mA ... 0 ... 10 mA 1-channel bipolar	-20 mA ... 0 ... 20 mA 1-channel bipolar	0 ... 5 V / 1 ... 5 V 1-channel	0 ... 10 V / 2 ... 10 V 1-channel	2 x 0 ... 5 V / 2 x 1 ... 5 V 2-channel / splitter	2 x 0 ... 10 V / 2 x 2 ... 10 V 2-channel / splitter	-10 V ... 0 ... 10 V 1-channel	
		ACT20M-UI-A0-S	ACT20M-UI-A0-S		ACT20M-AI-2A0-S	ACT20M-AI-2A0-S	
		ACT20M-AI-A0-E-S	ACT20M-AI-A0-E-S				
		ACT20M-AI-A0-S	ACT20M-AI-A0-S				
		ACT20M-UI-A0-S	ACT20M-UI-A0-S				
				ACT20M-AI-2A0-S	ACT20M-AI-2A0-S		
		ACT20M-AI-A0-E-S	ACT20M-AI-A0-E-S				
		ACT20M-AI-A0-S	ACT20M-AI-A0-S				
ACT20M-BAI-2A0-S	ACT20M-BAI-2A0-S	ACT20M-BAI-A0-S	ACT20M-BAI-A0-S	ACT20M-BAI-2A0-S	ACT20M-BAI-2A0-S		
ACT20M-BAI-2A0-S	ACT20M-BAI-2A0-S	ACT20M-BAI-A0-S	ACT20M-BAI-A0-S	ACT20M-BAI-2A0-S	ACT20M-BAI-2A0-S		
		ACT20M-UI-A0-S	ACT20M-UI-A0-S				
		ACT20M-AI-A0-S	ACT20M-AI-A0-S				
		ACT20M-UI-A0-S	ACT20M-UI-A0-S				
		ACT20M-AI-A0-E-S	ACT20M-AI-A0-E-S				
		ACT20M-AI-A0-S	ACT20M-AI-A0-S				
		ACT20M-UI-A0-S	ACT20M-UI-A0-S				
		ACT20M-AI-A0-E-S	ACT20M-AI-A0-E-S				
		ACT20M-AI-A0-S	ACT20M-AI-A0-S				
		ACT20M-BAI-A0-S	ACT20M-BAI-A0-S	ACT20M-BAI-2A0-S	ACT20M-BAI-2A0-S		
		ACT20M-BAI-A0-S	ACT20M-BAI-A0-S	ACT20M-BAI-2A0-S	ACT20M-BAI-2A0-S		

ACT20M – Selection table

Signal converters in 6 mm width

C

		Power supply	Function	Current				
				0 ... 20 mA 1-channel	4 ... 20 mA 1-channel	2 x 0 ... 20 mA 2-channel / splitter	2 x 4 ... 20 mA 2-channel / splitter	
Input	2-, 3-, 4-conductor	PT100	Output Loop Powered	Temp.		ACT20M-RTCI-CO-OLP-S		
				Temp.		ACT20M-RTCI-CO-EOLP-S		
			24 V DC	Temp.	ACT20M-RTI-AO-E-S	ACT20M-RTI-AO-E-S		
				Temp.				
		24 V DC and rail bus	universal	ACT20M-UI-AO-S	ACT20M-UI-AO-S			
			Temp.	ACT20M-RTI-AO-S	ACT20M-RTI-AO-S			
			Temp.					
		PT1000	24 V DC and rail bus	universal	ACT20M-UI-AO-S	ACT20M-UI-AO-S		
		Ni100	24 V DC and rail bus	universal	ACT20M-UI-AO-S	ACT20M-UI-AO-S		
		Ni1000	24 V DC and rail bus	universal	ACT20M-UI-AO-S	ACT20M-UI-AO-S		
	TC	B	24 V DC and rail bus	universal	ACT20M-UI-AO-S	ACT20M-UI-AO-S		
		E	24 V DC and rail bus	universal	ACT20M-UI-AO-S	ACT20M-UI-AO-S		
		J	Output Loop Powered	Temp.		ACT20M-RTCI-CO-OLP-S		
			24 V DC	Temp.	ACT20M-TCI-AO-E-S	ACT20M-TCI-AO-E-S		
			24 V DC and rail bus	universal	ACT20M-UI-AO-S	ACT20M-UI-AO-S		
				Temp.	ACT20M-TCI-AO-S	ACT20M-TCI-AO-S		
		24 V DC	Temp.					
			Temp.	ACT20M-RTI-AO-S	ACT20M-RTI-AO-S			
			K	Output Loop Powered	Temp.		ACT20M-RTCI-CO-OLP-S	
				24 V DC and rail bus	Temp.	ACT20M-TCI-AO-E-S	ACT20M-TCI-AO-E-S	
universal	ACT20M-UI-AO-S	ACT20M-UI-AO-S						
Temp.								
Temp.	ACT20M-TCI-AO-S	ACT20M-TCI-AO-S						
Temp.	ACT20M-RTI-AO-S	ACT20M-RTI-AO-S						
L	24 V DC and rail bus	universal	ACT20M-UI-AO-S	ACT20M-UI-AO-S				
LR	24 V DC and rail bus	universal	ACT20M-UI-AO-S	ACT20M-UI-AO-S				
N	24 V DC and rail bus	universal	ACT20M-UI-AO-S	ACT20M-UI-AO-S				
R	24 V DC and rail bus	universal	ACT20M-UI-AO-S	ACT20M-UI-AO-S				
S	24 V DC and rail bus	universal	ACT20M-UI-AO-S	ACT20M-UI-AO-S				
T	24 V DC and rail bus	universal	ACT20M-UI-AO-S	ACT20M-UI-AO-S				
U	24 V DC and rail bus	universal	ACT20M-UI-AO-S	ACT20M-UI-AO-S				
W3	24 V DC and rail bus	universal	ACT20M-UI-AO-S	ACT20M-UI-AO-S				
W5	24 V DC and rail bus	universal	ACT20M-UI-AO-S	ACT20M-UI-AO-S				
Poti	10R ... 100k	24 V DC and rail bus	universal	ACT20M-UI-AO-S	ACT20M-UI-AO-S			
R	10R ... 100k	24 V DC and rail bus	universal	ACT20M-UI-AO-S	ACT20M-UI-AO-S			

Note: *) available from July 2013

ACT20M - Overview

Signal converters in 6 mm width

Output		Voltage					
-10 mA ... 0 ... 10 mA 1-channel bipolar	-20 mA ... 0 ... 20 mA 1-channel bipolar	0 ... 5 V / 1 ... 5 V 1-channel	0 ... 10 V / 2 ... 10 V 1-channel	2 x 0 ... 5 V / 2 x 1 ... 5 V 2-channel / splitter	2 x 0 ... 10 V / 2 x 2 ... 10 V 2-channel / splitter	-10 V ... 0 ... 10 V 1-channel	
		ACT20M-RTI-A0-E-S	ACT20M-RTI-A0-E-S				
		ACT20M-UI-A0-S	ACT20M-UI-A0-S				
		ACT20M-RTI-A0-S	ACT20M-RTI-A0-S				
		ACT20M-RTCI-A0-S	ACT20M-RTCI-A0-S				
		ACT20M-UI-A0-S	ACT20M-UI-A0-S				
		ACT20M-UI-A0-S	ACT20M-UI-A0-S				
		ACT20M-UI-A0-S	ACT20M-UI-A0-S				
		ACT20M-UI-A0-S	ACT20M-UI-A0-S				
		ACT20M-UI-A0-S	ACT20M-UI-A0-S				
		ACT20M-TCI-A0-E-S	ACT20M-TCI-A0-E-S				
		ACT20M-UI-A0-S	ACT20M-UI-A0-S				
		ACT20M-TCI-A0-S	ACT20M-TCI-A0-S				
		ACT20M-RTI-A0-S	ACT20M-RTI-A0-S				
		ACT20M-TCI-A0-E-S	ACT20M-TCI-A0-E-S				
		ACT20M-UI-A0-S	ACT20M-UI-A0-S				
		ACT20M-TCI-A0-S	ACT20M-TCI-A0-S				
		ACT20M-RTI-A0-S	ACT20M-RTI-A0-S				
		ACT20M-UI-A0-S	ACT20M-UI-A0-S				
		ACT20M-UI-A0-S	ACT20M-UI-A0-S				
		ACT20M-UI-A0-S	ACT20M-UI-A0-S				
		ACT20M-UI-A0-S	ACT20M-UI-A0-S				
		ACT20M-UI-A0-S	ACT20M-UI-A0-S				
		ACT20M-UI-A0-S	ACT20M-UI-A0-S				
		ACT20M-UI-A0-S	ACT20M-UI-A0-S				
		ACT20M-UI-A0-S	ACT20M-UI-A0-S				
		ACT20M-UI-A0-S	ACT20M-UI-A0-S				
		ACT20M-UI-A0-S	ACT20M-UI-A0-S				
		ACT20M-UI-A0-S	ACT20M-UI-A0-S				
		ACT20M-UI-A0-S	ACT20M-UI-A0-S				
		ACT20M-UI-A0-S	ACT20M-UI-A0-S				
		ACT20M-UI-A0-S	ACT20M-UI-A0-S				
		ACT20M-UI-A0-S	ACT20M-UI-A0-S				

C

ACT20M

Signal splitter

- Isolation and doubling of DC signals
- Power supply via the mounting rail bus
- 4-way isolation

ACT20M-CI-2CO-S

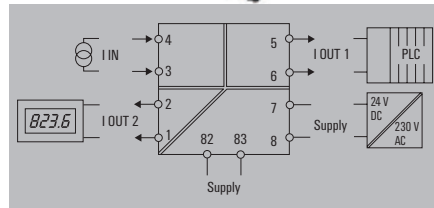
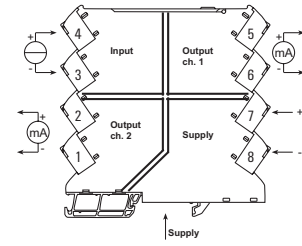

Technical data

Input	
Input current	0...20 mA, 4...20mA
Voltage drop, current input	< 1.5 V
Output	
Output current	0...20 mA, 4...20 mA
load impedance current	< 300 Ω, per channel, @ max 23mA
General data	
Configuration	none
Supply voltage	24 V DC ± 30 %
Ambient temperature	-25 °C...70 °C
Accuracy	< 0.05 % of measuring range
Temperature coefficient	≤ 0.01 % / °C
Cut-off frequency (-3 dB)	100 Hz
Power consumption, typ.	400 mW
Power consumption, max.	0.8 W
Step response time	≤ 7 ms
Insulation coordination	
Insulation voltage	2.5 kV _{eff} / 1 min.
Rated voltage	300 V _{eff}
EMC standards	IEC 61326-1, NE 21
Pollution degree	2
Overvoltage category	II
Approvals	CE; cULus; DETNORVER; EAC; FMEX; GL; GOSTME25; IECEXKEM; KEMAATEX

Electrical connections

Terminal	ACT20M-CI-2CO-S			
	Input mA	Power Supply	Output 1 mA	Output 2 mA
1				□
2				■
3	□			
4	■			
5			■	
6			□	
7		■		
8		□		

■ = +
□ = -

Dimensions

Clamping range (nominal / min. / max.)
Depth x width x height

Note

Screw connection

2.5 / 0.5 / 2.5
114.3 / 6.1 / 112.5

Power supply optionally over the DIN mounting rail CH20M

Ordering data

Screw connection

Type	Qty.	Order No.
ACT20M-CI-2CO-S	1	1175990000

Note

Accessories

Note

DIN mounting rail, see Accessories

ACT20M

Signal splitter

- Isolation, conversion and doubling of DC signals
- Configuration via DIP switches
- Power supply via the mounting rail bus
- 4-way isolation
- Support for adjustment by ACT20M Tool software, download link at www.weidmueller.com

ACT20M-AI-2AO-S

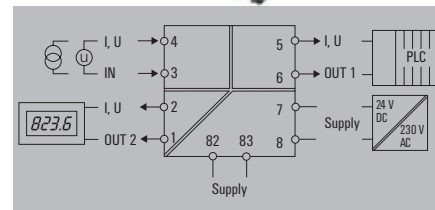
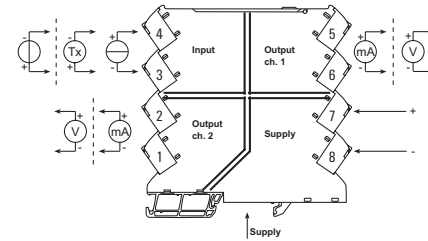

Technical data

Input	
Input current	0...20 mA, 4...20mA
Input voltage	0...10 V, 0...5 V
Sensor supply	> 17 V DC at 20 mA
Input resistance, voltage	500 kΩ
Voltage drop, current input	< 1.5 V
Output	
Output current	adjustable, 0...20 mA, 4...20 mA
Output voltage	adjustable, 0...10 V, 0...5 V
load impedance current	< 300 Ω, per channel, @ max 23mA
load impedance voltage	≥ 10 kΩ
General data	
Configuration	DIP switch
Supply voltage	24 V DC ± 30 %
Ambient temperature	-25 °C...70 °C
Accuracy	< 0.05 % of measuring range
Temperature coefficient	≤ 0.01 % / °C
Cut-off frequency (-3 dB)	100 Hz
Power consumption, typ.	400 mW
Power consumption, max.	1.2 W
Step response time	≤ 7 ms
Insulation coordination	
Insulation voltage	2.5 kV _{eff} / 1 min.
Rated voltage	300 V _{eff}
EMC standards	IEC 61326-1, NE 21
Pollution degree	2
Overvoltage category	II
Approvals	CE; cULus; DETNORVER; EAC; FMEX; GL; GOSTME25; IECExKEM; KEMAATEX

Dimensions	Screw connection
Clamping range (nominal / min. / max.)	2.5 / 0.5 / 2.5
Depth x width x height	114.3 / 6.1 / 112.5
Note	Power supply optionally over the DIN mounting rail CH20M

Ordering data	Type	Qty.	Order No.
Screw connection	ACT20M-AI-2AO-S	1	1176020000

Note	

Accessories	
Note	DIN mounting rail, see Accessories

Electrical connections

Terminal	ACT20M-AI-2AO-S							
	Input			Power supply	Output 1		Output 2	
	V	mA	mA Loop		V	mA	V	mA
1							<input type="checkbox"/>	<input type="checkbox"/>
2							<input checked="" type="checkbox"/>	<input checked="" type="checkbox"/>
3	<input checked="" type="checkbox"/>	<input type="checkbox"/>	<input checked="" type="checkbox"/>					
4	<input type="checkbox"/>	<input checked="" type="checkbox"/>	<input type="checkbox"/>					
5					<input checked="" type="checkbox"/>	<input checked="" type="checkbox"/>		
6						<input type="checkbox"/>	<input type="checkbox"/>	
7				<input checked="" type="checkbox"/>				
8				<input type="checkbox"/>				

DIP switch settings

Range	Input				Output 1				Output 2			
	1	2	3	4	5	6	7	8	9	10		
0...20 mA	<input type="checkbox"/>	<input type="checkbox"/>	<input type="checkbox"/>	<input type="checkbox"/>	<input type="checkbox"/>	<input type="checkbox"/>	<input type="checkbox"/>	<input type="checkbox"/>	<input type="checkbox"/>	<input type="checkbox"/>		
4...20 mA	<input type="checkbox"/>	<input checked="" type="checkbox"/>	<input type="checkbox"/>	<input type="checkbox"/>	<input type="checkbox"/>	<input type="checkbox"/>	<input type="checkbox"/>	<input type="checkbox"/>	<input type="checkbox"/>	<input type="checkbox"/>		
0...10 V	<input checked="" type="checkbox"/>	<input type="checkbox"/>	<input type="checkbox"/>	<input type="checkbox"/>	<input checked="" type="checkbox"/>	<input type="checkbox"/>	<input type="checkbox"/>	<input checked="" type="checkbox"/>	<input type="checkbox"/>	<input type="checkbox"/>		
2...10 V	<input type="checkbox"/>	<input checked="" type="checkbox"/>	<input type="checkbox"/>	<input type="checkbox"/>	<input type="checkbox"/>	<input type="checkbox"/>	<input type="checkbox"/>	<input checked="" type="checkbox"/>	<input type="checkbox"/>	<input type="checkbox"/>		
0...5 V	<input checked="" type="checkbox"/>	<input type="checkbox"/>	<input checked="" type="checkbox"/>	<input checked="" type="checkbox"/>	<input type="checkbox"/>	<input type="checkbox"/>	<input checked="" type="checkbox"/>	<input checked="" type="checkbox"/>	<input type="checkbox"/>	<input checked="" type="checkbox"/>		
1...5 V	<input checked="" type="checkbox"/>	<input checked="" type="checkbox"/>	<input checked="" type="checkbox"/>	<input checked="" type="checkbox"/>	<input checked="" type="checkbox"/>	<input checked="" type="checkbox"/>	<input checked="" type="checkbox"/>	<input checked="" type="checkbox"/>	<input checked="" type="checkbox"/>	<input checked="" type="checkbox"/>		
0...20 mA loop	<input checked="" type="checkbox"/>	<input type="checkbox"/>	<input type="checkbox"/>	<input type="checkbox"/>								
4...20 mA loop	<input checked="" type="checkbox"/>	<input type="checkbox"/>	<input checked="" type="checkbox"/>	<input type="checkbox"/>								

- = on
- = off

Signal converters in 6 mm width

C

ACT20M

Signal splitter

- Isolation and conversion of bipolar DC signals
- Splitting into standard signal or bipolar output
- Configuration via DIP switches
- Power supply via the mounting rail bus
- 4-way isolation
- Support for adjustment by ACT20M Tool software, download link at www.weidmuller.com

ACT20M-BAI-2A0-S

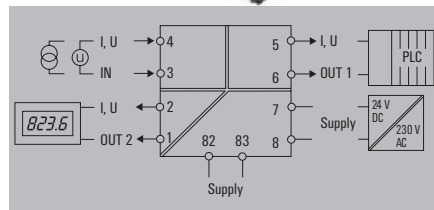
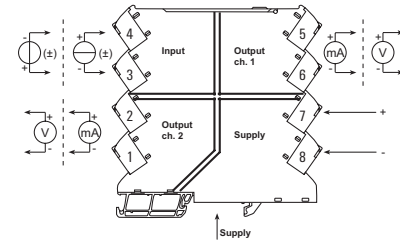

Technical data

Input	
Input current	-10 mA...0...+10 mA, -20 mA...0...+20 mA
Input voltage	-5 V...0...+5 V, -10 V...0...+10 V
Output	
Output current	adjustable, 0...20 mA, 4...20 mA, ±10mA, ±20mA
Output voltage	adjustable, 0...10 V, 0...5 V
load impedance current	< 300 Ω, per channel
load impedance voltage	≥ 10 kΩ
General data	
Supply voltage	24 V DC ± 30 %
Ambient temperature	-25 °C...70 °C
Storage temperature	-40 °C...85 °C
Accuracy	< 0.05 % of measuring range
Temperature coefficient	< 0.01% of span/°C (TU)
Cut-off frequency (-3 dB)	≥ 100 Hz, 10 Hz
Insulation coordination	
Insulation voltage	2.5 kV _{eff} / 1 min.
Rated voltage	300 V _{eff}
EMC standards	IEC 61326-1, NE 21
Pollution degree	2
Overvoltage category	II
Approvals	
Approvals	cULus; DETNORVER; EAC; FMEX; GL; IECEXKEM; KEMAATEX

Dimensions	
Clamping range (nominal / min. / max.)	2.5 / 0.5 / 2.5
Depth x width x height	114.3 / 6.1 / 112.5
Note	

Ordering data

Type	Qty.	Order No.
ACT20M-BAI-2A0-S	1	1375470000

Note	

Accessories

Note	
	DIN mounting rail, see accessories

Electrical connections

Terminal	ACT20M-BAI-2A0-S						
	Input		Power supply	Output 1		Output 2	
	V	mA		V	mA	V	mA
1						<input type="checkbox"/>	<input type="checkbox"/>
2						<input checked="" type="checkbox"/>	<input checked="" type="checkbox"/>
3	<input checked="" type="checkbox"/>	<input type="checkbox"/>					
4	<input type="checkbox"/>	<input checked="" type="checkbox"/>					
5				<input checked="" type="checkbox"/>	<input checked="" type="checkbox"/>		
6				<input type="checkbox"/>	<input type="checkbox"/>		
7			<input checked="" type="checkbox"/>				
8			<input type="checkbox"/>				

= +
 = -

DIP switch settings

Range	Bandwidth	Input		Output 1		Output 2						
		1	2	3	4	5	6	7	8	9	10	
10 Hz		<input checked="" type="checkbox"/>										
100 Hz		<input type="checkbox"/>										
-10...+10 mA		<input checked="" type="checkbox"/>	<input checked="" type="checkbox"/>									
-20...+20 mA		<input checked="" type="checkbox"/>	<input checked="" type="checkbox"/>	<input type="checkbox"/>								
-5...+5 V		<input type="checkbox"/>	<input type="checkbox"/>	<input checked="" type="checkbox"/>								
-10...+10 V		<input type="checkbox"/>	<input type="checkbox"/>	<input type="checkbox"/>								
0...20 mA				<input type="checkbox"/>	<input type="checkbox"/>	<input type="checkbox"/>	<input type="checkbox"/>	<input type="checkbox"/>	<input type="checkbox"/>	<input type="checkbox"/>	<input type="checkbox"/>	<input type="checkbox"/>
4...20 mA				<input type="checkbox"/>	<input checked="" type="checkbox"/>	<input type="checkbox"/>	<input type="checkbox"/>	<input type="checkbox"/>	<input type="checkbox"/>	<input type="checkbox"/>	<input type="checkbox"/>	<input type="checkbox"/>
0...10 V				<input checked="" type="checkbox"/>	<input type="checkbox"/>	<input type="checkbox"/>	<input checked="" type="checkbox"/>	<input type="checkbox"/>	<input type="checkbox"/>	<input type="checkbox"/>	<input type="checkbox"/>	<input type="checkbox"/>
2...10 V				<input checked="" type="checkbox"/>	<input type="checkbox"/>	<input type="checkbox"/>	<input checked="" type="checkbox"/>	<input checked="" type="checkbox"/>	<input type="checkbox"/>	<input type="checkbox"/>	<input type="checkbox"/>	<input type="checkbox"/>
0...5 V				<input checked="" type="checkbox"/>	<input type="checkbox"/>	<input checked="" type="checkbox"/>	<input checked="" type="checkbox"/>	<input checked="" type="checkbox"/>	<input type="checkbox"/>	<input type="checkbox"/>	<input type="checkbox"/>	<input type="checkbox"/>
1...5 V				<input checked="" type="checkbox"/>	<input checked="" type="checkbox"/>	<input checked="" type="checkbox"/>	<input checked="" type="checkbox"/>	<input checked="" type="checkbox"/>	<input checked="" type="checkbox"/>	<input checked="" type="checkbox"/>	<input checked="" type="checkbox"/>	<input checked="" type="checkbox"/>
±20 mA set-up				<input type="checkbox"/>	<input type="checkbox"/>	<input type="checkbox"/>	<input type="checkbox"/>	<input type="checkbox"/>	<input type="checkbox"/>	<input type="checkbox"/>	<input type="checkbox"/>	<input type="checkbox"/>
±10 mA set-up				<input type="checkbox"/>	<input checked="" type="checkbox"/>	<input checked="" type="checkbox"/>	<input type="checkbox"/>	<input checked="" type="checkbox"/>	<input checked="" type="checkbox"/>	<input type="checkbox"/>	<input checked="" type="checkbox"/>	<input checked="" type="checkbox"/>

= on
 = off

ACT20M

Signal converters in 6 mm width

C

Signal isolator

- Isolation of DC signals
- Power supply via the mounting rail bus
- 3-way isolation

ACT20M-CI-CO-S

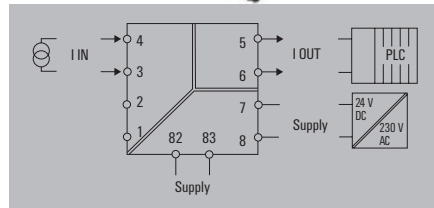
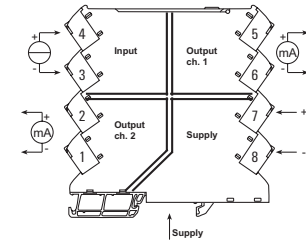

Technical data

Input	
Input current	0...20 mA, 4...20mA
Voltage drop, current input	< 1.5 V
Output	
Output current	0...20 mA, 4...20 mA
load impedance current	≤ 600 Ω, @ max 23mA
General data	
Configuration	none
Supply voltage	24 V DC ± 30 %
Ambient temperature	-25 °C...70 °C
Accuracy	< 0.05 % of measuring range
Temperature coefficient	≤ 0.01 % / °C
Cut-off frequency (-3 dB)	100 Hz
Power consumption, typ.	400 mW
Power consumption, max.	0.8
Step response time	≤ 7 ms
Insulation coordination	
Insulation voltage	2.5 kV _{eff} / 1 min.
Rated voltage	300 V _{eff}
EMC standards	IEC 61326-1, NE 21
Pollution degree	2
Overvoltage category	II
Approvals	CE; cULus; DETNORVER; EAC; FMEX; GL; GOSTME25; IECEXKEM; KEMAATEX

Input current	0...20 mA, 4...20mA
Voltage drop, current input	< 1.5 V
Output current	0...20 mA, 4...20 mA
load impedance current	≤ 600 Ω, @ max 23mA
Configuration	none
Supply voltage	24 V DC ± 30 %
Ambient temperature	-25 °C...70 °C
Accuracy	< 0.05 % of measuring range
Temperature coefficient	≤ 0.01 % / °C
Cut-off frequency (-3 dB)	100 Hz
Power consumption, typ.	400 mW
Power consumption, max.	0.8
Step response time	≤ 7 ms
Insulation voltage	2.5 kV _{eff} / 1 min.
Rated voltage	300 V _{eff}
EMC standards	IEC 61326-1, NE 21
Pollution degree	2
Overvoltage category	II
Approvals	CE; cULus; DETNORVER; EAC; FMEX; GL; GOSTME25; IECEXKEM; KEMAATEX

Electrical connections

Terminal	ACT20M-CI-CO-S		
	Input mA	Power Supply	Output 1 mA
1			
2			
3	□		
4	■		
5			■
6			□
7		■	
8		□	

■ = +
□ = -

Dimensions

Clamping range (nominal / min. / max.)
Depth x width x height

Note

Screw connection

2.5 / 0.5 / 2.5
114.3 / 6.1 / 112.5

Power supply optionally over the DIN mounting rail CH20M

Ordering data

Screw connection

Type	Qty.	Order No.
ACT20M-CI-CO-S	1	1175980000

Note

Accessories

Note

DIN mounting rail, see Accessories

ACT20M

Signal converter

- Isolation and conversion of DC signals
- Configuration via DIP switches
- Power supply via the mounting rail bus
- 3-way isolation
- Support for adjustment by ACT20M Tool software, download link at www.weidmuller.com

ACT20M-AI-AO-S

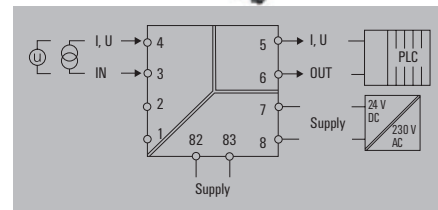
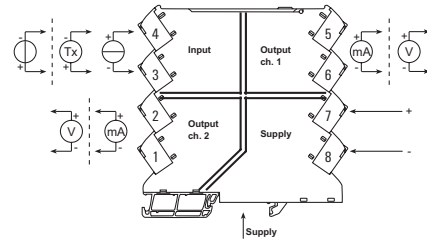

Technical data

Input	
Input current	0...20 mA, 4...20mA
Input voltage	0...10 V, 0...5 V
Sensor supply	> 17 V DC at 20 mA
Input resistance, voltage	>500 kΩ
Voltage drop, current input	<1,5 V
Output	
Output current	adjustable, 0...20 mA, 4...20 mA
Output voltage	adjustable, 0...10 V, 0...5 V
load impedance current	≤ 600 Ω, @ max 23mA
load impedance voltage	≥ 10 kΩ
General data	
Configuration	DIP switch
Supply voltage	24 V DC ± 30 %
Ambient temperature	-25 °C...70 °C
Accuracy	< 0.05 % of measuring range
Temperature coefficient	≤ 0.01 % / °C
Cut-off frequency (-3 dB)	100 Hz
Power consumption, typ.	400 mW
Power consumption, max.	1.2 W
Step response time	≤ 7 ms
Insulation coordination	
Insulation voltage	2.5 kV _{eff} / 1 min.
Rated voltage	300 V _{eff}
EMC standards	IEC 61326-1, NE 21
Pollution degree	2
Overvoltage category	II
Approvals	CE; cULus; DETNORVER; EAC; FMEX; GL; GOSTME25; IECExKEM; KEMAATEX

Dimensions	
Clamping range (nominal / min. / max.)	2.5 / 0.5 / 2.5
Depth x width x height	114.3 / 6.1 / 112.5
Note	
	Power supply optionally over the DIN mounting rail CH20M

Ordering data			
Type	Qty.	Order No.	
ACT20M-AI-AO-S	1	1176000000	Screw connection

Note	

Accessories	
Note	
	DIN mounting rail, see Accessories

Electrical connections

Terminal	ACT20M-AI-AO-S					
	Input			Power supply	Output 1	
	V	mA	mA Loop		V	mA
1						
2						
3	■	□	■			
4	□	■	□			
5					■	■
6					□	□
7				■		
8				□		

■ = +
□ = -

DIP switch settings

Range	Input				Output					
	1	2	3	4	5	6	7	8	9	10
0 ... 20 mA	□	□	□	□	□	□	□	□	□	□
4 ... 20 mA	□	■	□	□	□	■	□	□	□	□
0 ... 10 V	■	□	□	■	□	□	□	□	□	□
2 ... 10 V	■	■	□	■	□	□	□	□	□	□
0 ... 5 V	■	□	■	■	□	□	■	□	□	□
1 ... 5 V	■	■	■	■	■	■	■	■	■	■
0 ... 20 mA loop	■	□	□	□						
4 ... 20 mA loop	■	□	■	□						

■ = on
□ = off

ACT20M

Signal converters in 6 mm width

C

Signal converter

- Isolation and conversion of DC signals
- Configuration via DIP switches
- Power supply via the mounting rail bus
- 3-way isolation
- Support for adjustment by ACT20M Tool software, download link at www.weidmueller.com

ACT20M-AI-AO-E-S

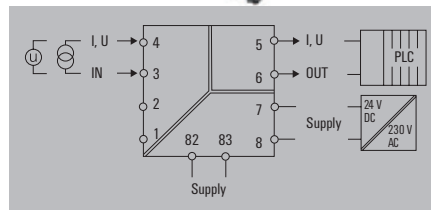
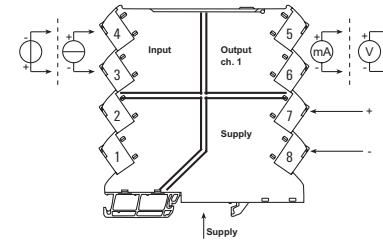

Technical data

Input	
Input current	0...20 mA, 4...20mA
Input voltage	0...10 V, 0...5 V
Input resistance, voltage	>500 kΩ
Voltage drop, current input	<1,5 V

Output	
Output current	adjustable, 0...20 mA, 4...20 mA
Output voltage	adjustable, 0...10 V, 0...5 V
load impedance current	≤ 600 Ω, @ max 23mA
load impedance voltage	≥ 10 kΩ

General data	
Configuration	DIP switch
Supply voltage	24 V DC ± 30 %
Ambient temperature	0 °C...70 °C
Accuracy	< 0.2 % of measuring range
Temperature coefficient	≤ 0.015 % / °C
Cut-off frequency (-3 dB)	100 Hz
Power consumption, typ.	400 mW
Power consumption, max.	1.2 W
Step response time	≤ 7 ms

Insulation coordination	
Insulation voltage	2.5 kV _{eff} / 1 min.
Rated voltage	300 V _{eff}
EMC standards	IEC 61326-1, NE 21
Pollution degree	2
Overvoltage category	II
Approvals	CE; cULus; DETNORVER; EAC; GL; GOSTME25

Dimensions	
Clamping range (nominal / min. / max.)	2.5 / 0.5 / 2.5
Depth x width x height	114.3 / 6.1 / 112.5

Note: Power supply optionally over the DIN mounting rail CH20M

Ordering data

Screw connection

Type	Qty.	Order No.
ACT20M-AI-AO-E-S	1	1176010000

Note

Accessories

Note: DIN mounting rail, see Accessories

Electrical connections

Terminal	ACT20M-AI-AO-E-S				
	Input		Power supply	Output 1	
	V	mA		V	mA
1					
2					
3	■	□			
4	□	■			
5				■	■
6				□	□
7			■		
8			□		

■ = +
□ = -

DIP switch settings

Range	Input				Output					
	1	2	3	4	5	6	7	8	9	10
0 ... 20 mA	□	□	□	□	□	□	□	□	□	□
4 ... 20 mA	□	■	□	□	□	■	□	□	□	□
0 ... 10 V	■	□	□	■	□	□	□	□	□	□
2 ... 10 V	■	■	□	□	□	□	□	□	□	□
0 ... 5 V	■	□	■	■	□	□	■	□	□	□
1 ... 5 V	■	■	■	■	■	■	■	■	■	■

■ = on
□ = off

ACT20M

Signal converter

- Isolation and conversion of bipolar DC signals into standard signals
- Configuration via DIP switches
- Power supply via the mounting rail bus
- 3-way isolation
- Support for adjustment by ACT20M Tool software, download link at www.weidmuller.com

ACT20M-BAI-AO-S

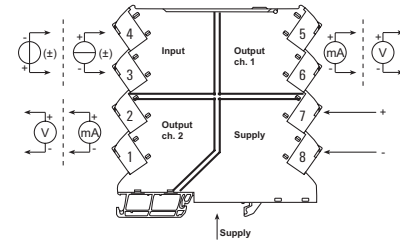
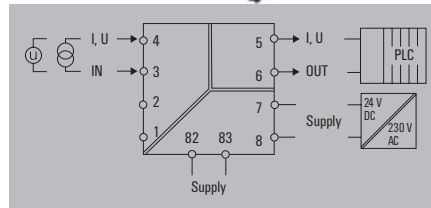

Technical data

Input	
Input current	-10 mA...0...+10 mA, -20 mA...0...+20 mA
Input voltage	-5 V...0...+5 V, -10 V...0...+10 V
Output	
Output current	0...20 mA, 4...20 mA
Output voltage	adjustable, 0...10 V, 0...5 V
load impedance current	≤ 600 Ω
load impedance voltage	≥ 10 kΩ
General data	
Configuration	DIP switch
Supply voltage	24 V DC ± 30 %
Ambient temperature	-25 °C...70 °C
Storage temperature	-40 °C...85 °C
Accuracy	< 0.05 % of measuring range
Temperature coefficient	< 0.01 % of span/°C (TU)
Cut-off frequency (-3 dB)	≥ 100 Hz, 10 Hz
Insulation coordination	
Insulation voltage	2.5 kV _{eff} / 1 min.
Rated voltage	300 V _{eff}
EMC standards	IEC 61326-1, NE 21
Pollution degree	2
Overvoltage category	II
Approvals	
Approvals	cULus; DETNORVER; EAC; FMEX; GL; IECEXKEM; KEMAATEX

Dimensions	
Clamping range (nominal / min. / max.)	2.5 / 0.5 / 2.5
Depth x width x height	114.3 / 6.1 / 112.5
Note	
Power supply optionally via mounting rail bus CH20M	

Ordering data

Type	Qty.	Order No.
ACT20M-BAI-AO-S	1	1375450000

Note

Accessories

Note
Mounting rail bus, see accessories

Electrical connections

Terminal	ACT20M-BAI-AO-S				
	Input		Power supply	Output 1	
	V	mA		V	mA
1					
2					
3	■	□			
4	□	■			
5				■	■
6				□	□
7			■		
8			□		
	■ = +				
	□ = -				

DIP switch settings

Range	Bandwidth	Input				Output					
		1	2	3	4	5	6	7	8	9	10
10 Hz	■										
100 Hz	□										
-10...+10 mA		■	■	■							
-20...+20 mA		■	■	□							
-5...+5 V		□	□	■							
-10...+10 V		□	□	□							
0...20 mA					□	□	□				
4...20 mA					□	■	□				
0...10 V					■	□	□				
2...10 V					■	■	□				
0...5 V					■	□	■				
1...5 V					■	■	■				
±20 mA set-up											
±10 mA set-up											

■ = on
□ = off

ACT20M

Universal measurement and signal converter

- Isolation and conversion of temperature signals and DC signals
- Configuration using FDT/DTM software
- Power supply via the mounting rail bus
- 3-way isolation

ACT20M-UI-A0-S

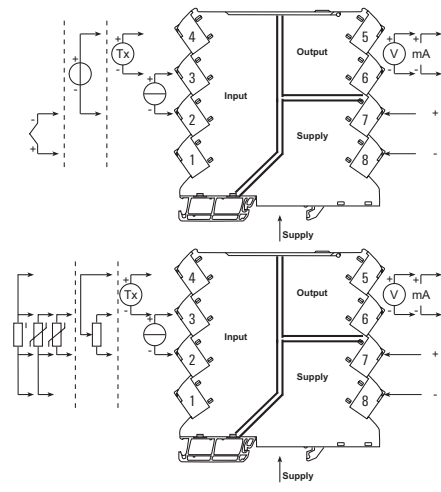
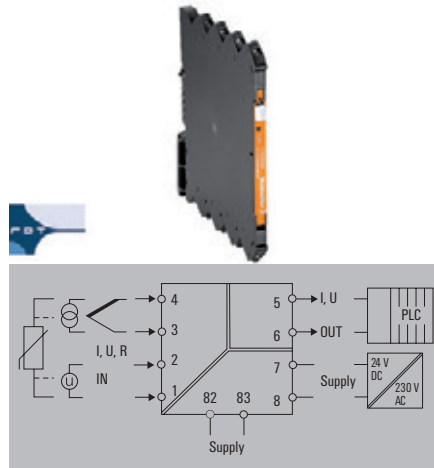

Signal converters in 6 mm width

C

Technical data

Input

Sensor

Potentiometer
Resistance
Input current
Input voltage
Input resistance, voltage
Voltage drop, current input
Sensor supply

Thermocouples: B, E, J, K, L, LR, N, R, N, R, S, T, U, W3, W5, RTD:
PT100, PT1000, Ni100, Ni1000, 2-/3-/4-wire
10 Ω...10 kΩ
10 Ω...10 kΩ
0...20 mA, 4...20mA
0...10 V, 0...5 V
> 10 MΩ
< 3 V
> 15 V DC at 20 mA

Output

Output current
Output voltage
load impedance current
load impedance voltage

adjustable, 0...20 mA, 4...20 mA
adjustable, 0...10 V, 0...5 V
≤ 600 Ω, @ max 28mA
≥ 10 kΩ

General data

Configuration
Supply voltage
Ambient temperature
Accuracy
Temperature coefficient
Power consumption, typ.
Power consumption, max.
Step response time

With FDT/DTM software
24 V DC ± 30 %
-25 °C...70 °C
≤ 0.1 % of measuring range
≤ 0.01 % / °C
400 mW
1.2 W
400 ms (10...90%) @ U/I, 1 s @ temp

Insulation coordination

Insulation voltage
Rated voltage
EMC standards
Pollution degree
Overvoltage category
Approvals

2.5 kV_{eff} / 1 min.
300 V_{eff}
IEC 61326-1, NE 21
2
II
cULus; DETNORVER; EAC; FMEX; GL; GOSTME25; IECEXKEM;
KEMAATEX

Dimensions

Clamping range (nominal / min. / max.)
Depth x width x height

Screw connection

2.5 / 0.5 / 2.5
114.3 / 6.1 / 112.5

Note

Power supply optionally over the DIN mounting rail CH20M

Ordering data

Screw connection

Type	Qty.	Order No.
ACT20M-UI-A0-S	1	1176030000

Note

Accessories

Note

CBX200 USB configuration adapter - 8978580000
DIN mounting rail, see Accessories

Electrical connections

Terminal	ACT20M-UI-A0-S						
	Input				Power supply	Output	
	V	mA	Loop	RTD		V	mA
1				Sense- Sense-	■		□
2	□	□		R R- R- R	□		
3			■	R R+ R+ R			
4	■			Sense+ R			
5						■	■
6							□
7						■	
8							□

■ = +
□ = -

ACT20M

Passive isolator

- Isolation of DC signals without additional voltage supply
- Supply from the input measuring circuit
- Optionally available as a 1-channel / 2-channel version
- 2-way isolation

ACT20M-CI-CO-ILP-S

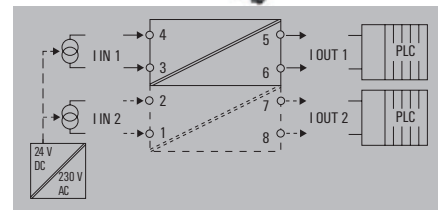
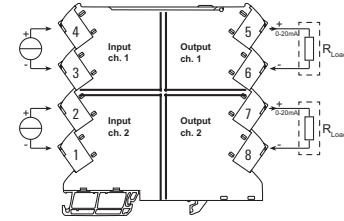

Technical data

Input	
Voltage drop, current input	1.25 V + 0.015 V _{ref} @25°C
Input current	0...20 mA, 4...20mA
Output	
Output current	0...20 mA, 4...20 mA
load impedance current	≤ 600 Ω, @ max 23mA
General data	
Configuration	none
Ambient temperature	-25 °C...70 °C
Accuracy	< 0.1 % of measuring range
Temperature coefficient	≤ 0.01 % / °C
Cut-off frequency (-3 dB)	100 Hz
Power consumption, max.	30 mW per channel
Supply voltage	Loop powered, via 4...20 mA input
Step response time	≤ 5 ms
Insulation coordination	
Insulation voltage	2.5 kV _{eff}
Rated voltage	300 V _{eff}
EMC standards	IEC 61326-1, NE 21
Pollution degree	2
Overvoltage category	II
Approvals	cULus; DETNORVER; EAC; FMEX; GL; GOSTME25; IECEXKEM; KEMAATEX

Electrical connections

Terminal	ACT20M-CI-2CO-S			
	Input 1	Output 1	Input 2	Output 2
	mA	mA	mA	mA
1			□	
2			■	
3	□			
4	■			
5		■		
6		□		
7				■
8				□

Electrical connections

Terminal	ACT20M-CI-CO-ILP-S	
	Input 1	Output 1
	mA	mA
1		
2		
3	□	
4	■	
5		■
6		□
7		
8		

■ = +
□ = -

Dimensions

Clamping range (nominal / min. / max.)
Depth x width x height

Note

Screw connection

2.5 / 0.5 / 2.5
114.3 / 6.1 / 112.5

Power supply optionally over the DIN mounting rail CH20M

Ordering data

Type	Qty.	Order No.
1-channel version	1	1176070000
2-channel version	1	1176080000

Note

Accessories

Note
DIN mounting rail, see Accessories

ACT20M

Passive isolator

- Isolation of DC signals without additional voltage supply
- Supply from the output measurement circuit
- Optionally available as a 1-channel / 2-channel version
- 2-way isolation

ACT20M-CI-CO-OLP-S

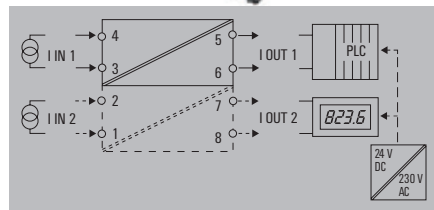
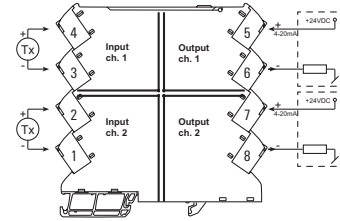

Technical data

Input	
Voltage drop, current input	Typical 2.5 V
Input current	4...20 mA
Output	
Output current	4...20 mA
General data	
Configuration	none
Ambient temperature	-25 °C...70 °C
Accuracy	< 0.05 % of measuring range
Temperature coefficient	≤ ± 0.07 μA x (Δ °C x V _{supply}) @ Tamb < 25 °C ≤ ± 0.02 μA x (Δ °C x V _{supply}) @ Tamb > 25 °C
Cut-off frequency (-3 dB)	100 Hz
Power consumption, max.	30 mW per channel
Supply voltage	Output loop powered
Step response time	≤ 5 ms
Insulation coordination	
Insulation voltage	2.5 kV _{eff} / 1 min.
Rated voltage	300 V _{eff}
EMC standards	IEC 61326-1, NE 21
Pollution degree	2
Overvoltage category	II
Approvals	cULus; DETNORVER; EAC; FMEX; GL; GOSTME25; IECEXKEM; KEMAATEX

Dimensions		Screw connection	
Clamping range (nominal / min. / max.)		2.5 / 0.5 / 2.5	
Depth x width x height		114.3 / 6.1 / 112.5	
Note		Power supply optionally over the DIN mounting rail CH20M	

Ordering data			
Type	Qty.	Order No.	
1-channel version	1	1176040000	
2-channel version	1	1176050000	

Note	

Accessories	
Note	
	DIN mounting rail, see Accessories

Electrical connections

Terminal	ACT20M-2CI-2CO-OLP-S			
	Input 1	Output 1	Input 2	Output 2
	mA	mA	mA	mA
1			■	□
2			■	
3	□			
4	■			
5		■		
6		□		
7				■
8				□

Terminal	ACT20M-CI-CO-OLP-S	
	Input 1	Output 1
	mA	mA
1		
2		
3	□	
4	■	
5		■
6		□
7		
8		

■ = +
□ = -

Signal converters in 6 mm width

C

ACT20M

Temperature transducer

- Isolation and conversion of temperature signals, (RTD and thermocouple)
- Configuration via DIP switches
- Power supply via the output circuit
- 2-way isolation

ACT20M-RTCI-CO-OLP-S

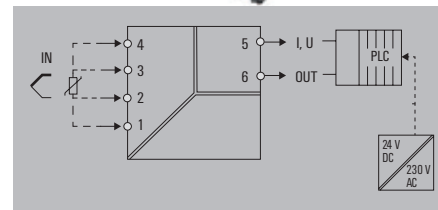
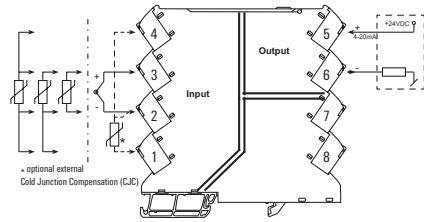

Technical data

Input	
Sensor	PT100 / 2-/3-/4-wire, Thermocouple acc. to IEC 584, type: J, Thermocouple acc. to IEC 584, type: K
Input measurement range	PT100 -200...+850 °C, Thermocouple type J -100...+1200°C, Thermocouple type K -200...+1370°C
Temperature input range	Configurable, min. measurement range 10°C (RTD), min. measurement range 50°C (TC)
Output	
Output current	adjustable, 4...20 mA, 20...4 mA
Sensor error detection	3.5 mA / 23 mA / none
General data	
Configuration	DIP switch
Supply voltage	Output loop powered, 6...35 V
Power consumption	ca. 1 W
Storage temperature	-40 °C...85 °C
Accuracy	absolute accuracy: $\pm 0.05\%$ of the measurement range, RTD (PT100) Basic accuracy: $\pm 0.1\%$ of the measurement range, TC (J,K) Basic accuracy: $\pm 0.5\%$ of the measurement range
Galvanic isolation	2-way isolator
Step response time	≤ 30 ms, ≤ 300 ms
Ambient temperature	-25 °C...+70 °C
Insulation coordination	
Insulation voltage	2.5 kV _{eff} / 1 min.
Rated voltage	300 V _{eff}
EMC standards	IEC 61326-1, NE 21
Pollution degree	2
Overvoltage category	II
Approvals	
Approvals	cULus; DETNORVER; EAC; FMEX; GL; ICEXKEM; KEMAATEX

Dimensions	Screw connection
Clamping range (nominal / min. / max.)	2.5 / 0.5 / 2.5
Depth x width x height	114.3 / 6.1 / 112.5
Note	

Ordering data	Type	Qty.	Order No.
	ACT20M-RTCI-CO-OLP-S	1	1435590000

Note	

Accessories	Note
	DIN mounting rail, see accessories

Electrical connections

Terminal	ACT20M-RTCI-CO-OLP-S				
	Input				Output 1
	RTD		TC		mA
	2 wire	3 wire	4 wire	TC	
1		Sense-	Sense-	CJC+*	
2	R	R-	R-	TC-/CJC+*	
3	R	R+	R+	TC+	
4		Sense+		CJC+*	
5					■
6					□
7					
8					

* optional

■ = +

□ = -

Configuration

Temp.	Temperature range [°C]									
	Pt100: -200...+850 °C // TC J: -100...+1200 °C					TC K: -180...+1372 °C				
	Min.	S2	Max.	S2	Max.	S2	Max.	S2	Max.	S2
-200			0				170			
-180			5				180			
-150			10				190			
-100			15				200			
-50			20				225			
-25			25				250			
-10			30				275			
-5			35				300			
0			40				325			
5			45				350			
10			50				375			
20			55				400			
25			60				450			
50			65				500			
100			70				550			
200			75				600			
			80				650			
			85				700			
			90				750			
			95				800			
			100				850			
			105				900			
			110				950			
			115				1000			
			120				1050			
			125				1100			
			130				1150			
			135				1200			
			140				1250			
			145				1300			
			150				1350			
			160				1372			

■ = On

ACT20M

Temperature transducer

- Conversion of temperature signals, RTD
- Configuration via DIP switches
- Power supply via the output circuit

ACT20M-RTI-CO-EOLP-S

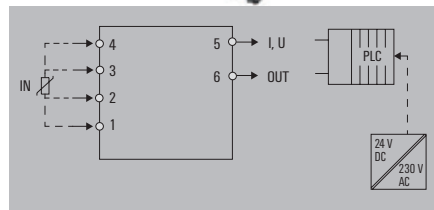
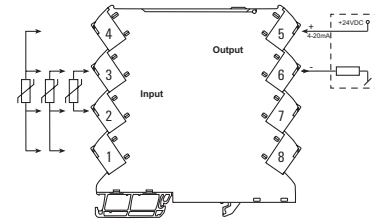

Signal converters in 6 mm width

C

Technical data

Input	
Sensor	PT100 / 2/3/4-wire
Input measurement range	PT100 -200...+850 °C
Temperature input range	Configurable, min. measurement range 10°C (RTD)
Output	
Output current	adjustable, 4...20 mA, 20...4 mA
Sensor error detection	3.5 mA / 23 mA / none
General data	
Configuration	DIP switch
Supply voltage	Output loop powered, 6...35 V
Power consumption	ca. 1 W
Storage temperature	-40 °C...85 °C
Accuracy	absolute accuracy: $\pm 0.1\%$ of the measurement range, Basic accuracy: $\pm 0.2^\circ\text{C}$
Galvanic isolation	Without isolation
Step response time	$\le 30\text{ ms}$, $\le 300\text{ ms}$
Ambient temperature	-25 °C...+70 °C
EMC standards	IEC 61326-1, NE 21
Approvals	
Approvals	cULus; DETNORVER; EAC; FMEX; GL; IECEXKEM; KEMAATEX

Electrical connections

Terminal	ACT20M-RTI-CO-EOLP-S			Output 1 mA
	Input			
	RTD			
	2 wire	3 wire	4 wire	
1		Sense-	Sense-	
2	R	R-	R-	
3	R	R+	R+	
4			Sense+	
5				■
6				□
7				
8				

* optional
 ■ = +
 □ = -

Configuration

Temp.	Temperature range [°C]										
	Pt100: -200...+850 °C // TC J: -100...+1200 °C					TC K: -180...+1372 °C					
Min.	S2	Max.	S2	Max.	S2	Max.	S2	Max.	S2	Max.	
Temp.	1	2	3	4	Temp.	5	6	7	8	9	10
-200					0					170	■
-180					5					180	■
-150					10					190	■
-100					15					200	■
-50					20					225	■
-25					25					250	■
-10					30					275	■
-5					35					300	■
0					40					325	■
5					45					350	■
10					50					375	■
20					55					400	■
25					60					450	■
50					65					500	■
100					70					550	■
200					75					600	■
					80					650	■
					85					700	■
					90					750	■
					95					800	■
					100					850	■
					105					900	■
					110					950	■
					115					1000	■
					120					1050	■
					125					1100	■
					130					1150	■
					135					1200	■
					140					1250	■
					145					1300	■
					150					1350	■
					160					1372	■

■ = On

Dimensions

Clamping range (nominal / min. / max.)
 Depth x width x height

Note

Screw connection

2.5 / 0.5 / 2.5
 114.3 / 6.1 / 112.5

Ordering data

Type	Qty.	Order No.
ACT20M-RTI-CO-EOLP-S	1	1435610000

Note

Accessories

Note

DIN mounting rail, see accessories

ACT20M

Temperature transducer

- Isolation and conversion of temperature signals, RTD (PT100)
- Configuration via DIP switches
- Power supply via the mounting rail bus
- 3-way isolation

ACT20M-RTI-AO-S

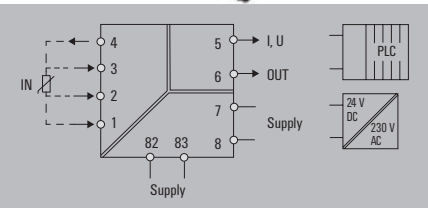
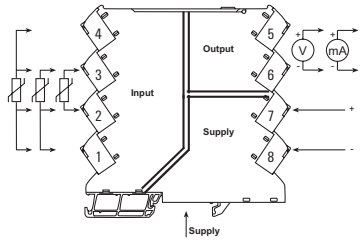

Technical data

Input	
Sensor	PT100 / 2-/3-/4-wire
Input measurement range	PT100 -200...+850 °C
Temperature input range	Configurable, min. measurement range 10°C (RTD)
Output	
Output current	adjustable, 0...20 mA, 4...20 mA
Output voltage	adjustable, 0...5 V, 0...10 V
load impedance current	≤ 600 Ω
load impedance voltage	≥ 10 kΩ
Sensor error detection	3.5 mA / 23 mA / none
General data	
Configuration	DIP switch
Supply voltage	24 V DC ± 30 %
Power consumption	0.7 W
Accuracy	absolute accuracy: < ±0.05 % of the measurement range, Basic accuracy: < ±0.1°C
Galvanic isolation	3-way isolator
Temperature coefficient	≤ 0.01 % of the measurement range/°C or 0.02 °C/°C
Step response time	≤ 30 ms, < 300 ms
Ambient temperature	-25 °C...+70 °C
Insulation coordination	
Insulation voltage	2.5 kV _{eff} / 1 min.
Rated voltage	300 V _{eff}
EMC standards	IEC 61326-1, NE 21
Pollution degree	2
Overvoltage category	II
Approvals	
Approvals	cULus; DETNORVER; EAC; FMEX; GL; IECEXKEM; KEMAATEX

Dimensions	
Clamping range (nominal / min. / max.)	2.5 / 0.5 / 2.5
Depth x width x height	114.3 / 6.1 / 112.5
Note	

Ordering data			
Type	Qty.	Order No.	
ACT20M-RTI-AO-S	1	1375510000	

Note	
------	--

Accessories	
Note	DIN mounting rail, see accessories

Electrical connections

ACT20M-RTI-AO-S						
Terminal	Input			Power supply	Output 1	
	RTD				V	mA
	2 wire	3 wire	4 wire			
1		Sense-	Sense-			
2	R	R-	R-			
3	R	R+	R+			
4		Sense+				
5				■	■	
6				□	□	
7				■		
8				□		

■ = +
□ = -

Configuration

Temperature range [°C]																		
Pt100: -200...+850 °C																		
Min.	S2			Max.	S2			Max.	S2									
Temp.	1	2	3	4	Temp.	5	6	7	8	9	10	Temp.	5	6	7	8	9	10
-200					0							170						
-180				■	5							180						■
-150				■	10							190						■
-100				■	15							200						■
-50				■	20							225						■
-25				■	25							250						■
-10				■	30							275						■
-5				■	35							300						■
0				■	40							325						■
5				■	45							350						■
10				■	50							375						■
20				■	55							400						■
25				■	60							450						■
50				■	65							500						■
100				■	70							550						■
200				■	75							600						■
					80							650						■
					85							700						■
					90							750						■
					95							800						■
					100							850						■
					105							900						■
					110							950						■
					115							1000						■
					120							1050						■
					125							1100						■
					130							1150						■
					135							1200						■
					140							1250						■
					145							1300						■
					150							1350						■
					160							1372						■

■ = On

ACT20M

Signal converters in 6 mm width

C

Temperature transducer

- Conversion of temperature signals, RTD (PT100)
- Configuration via DIP switches

ACT-20M-RTI-AO-E-S

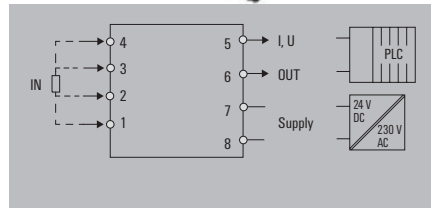
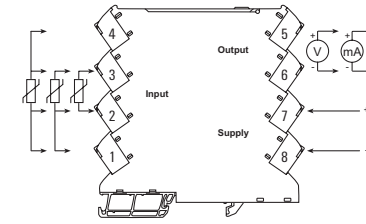

Technical data

Input	
Sensor	PT100 / 2-/3-/4-wire
Input measurement range	PT100 -200...+850 °C
Temperature input range	Configurable, min. measurement range 10°C (RTD)
Output	
Output current	adjustable, 0...20 mA, 4...20 mA
Output voltage	adjustable, 0...5 V, 0...10 V
load impedance current	≤ 600 Ω
load impedance voltage	≥ 10 kΩ
Sensor error detection	3.5 mA / 23 mA / none
General data	
Configuration	DIP switch
Supply voltage	24 V DC ± 30 %
Power consumption	0.7 W
Accuracy	absolute accuracy: < ±0.1 % of the measurement range
Galvanic isolation	Without isolation
Temperature coefficient	≤ 0.01 % of the measurement range/°C or 0.02 °C/°C
Step response time	≤ 30 ms, < 300 ms
Ambient temperature	-25 °C...+70 °C
EMC standards	IEC 61326-1, NE 21
Approvals	
Approvals	cULus; DETNORVER; EAC; FMEX; GL; IECEXKEM; KEMAATEX

Screw connection	
Clamping range (nominal / min. / max.)	2.5 / 0.5 / 2.5
Depth x width x height	114.3 / 6.1 / 112.5

Dimensions	
Clamping range (nominal / min. / max.)	2.5 / 0.5 / 2.5
Depth x width x height	114.3 / 6.1 / 112.5

Ordering data			
Type	Qty.	Order No.	
ACT20M-RTI-AO-E-S	1	1375520000	

Note

Accessories	
Note	DIN mounting rail, see accessories

Electrical connections

Terminal	ACT20M-RTI-AO-E-S			
	Input			Power supply
	RTD			
	2 wire	3 wire	4 wire	
1		Sense-	Sense-	
2	R	R-	R-	
3	R	R+	R+	
4		Sense+		
5				■
6				□
7				■
8				□

■ = +
□ = -

Configuration

Temp.	Temperature range [°C]									
	Pt100: -200...+850 °C									
	Min.	S2	Max.	S2	Max.	S2	Max.	S2	Max.	S2
-200			0				170			
-180			5				180			
-150			10				190			
-100			15				200			
-50			20				225			
-25			25				250			
-10			30				275			
-5			35				300			
0			40				325			
5			45				350			
10			50				375			
20			55				400			
25			60				450			
50			65				500			
100			70				550			
200			75				600			
			80				650			
			85				700			
			90				750			
			95				800			
			100				850			
			105				900			
			110				950			
			115				1000			
			120				1050			
			125				1100			
			130				1150			
			135				1200			
			140				1250			
			145				1300			
			150				1350			
			160				1372			

■ = On

ACT20M

Temperature transducer

- Isolation and conversion of temperature signals, (thermocouple)
- Configuration via DIP switches
- Power supply via the mounting rail bus
- 3-way isolation

ACT20M-TCI-A0-S

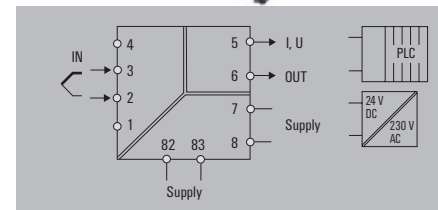
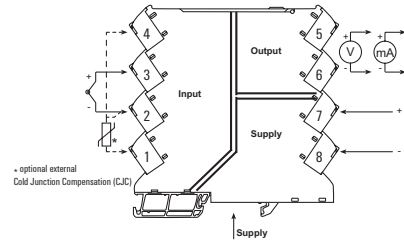

Technical data

Input	Thermocouple (type J, K) Thermocouple type J -100...+1200°C, Thermocouple type K -200...+1370°C Configurable, min. measurement range 50°C (TC)
Sensor	
Input measurement range	
Temperature input range	
Output	adjustable, 0...20 mA, 4...20 mA adjustable, 0...5 V, 0...10 V ≤ 600 Ω ≥ 10 kΩ 3.5 mA/23 mA/none
Output current	
Output voltage	
load impedance current	
load impedance voltage	
Sensor error detection	
General data	DIP switch 24 V DC ± 30 % 0.7 W absolute accuracy: < ±0.05 % of the measurement range, Basic accuracy: < ±0.5°
Configuration	
Supply voltage	
Power consumption	
Accuracy	
Galvanic isolation	3-way isolator
Temperature coefficient	0,1 °C/°C, or, ≤0,01% des Messbereichs/°C
Step response time	≤ 30 ms, < 300 ms, Configurable
Ambient temperature	-25 °C...+70 °C
Insulation coordination	2.5 kV _{eff} / 1 min. 300 V _{eff} IEC 61326-1, NE 21 2 II
Insulation voltage	
Rated voltage	
EMC standards	
Pollution degree	
Overvoltage category	
Approvals	cULus; DETNORVER; EAC; FMEX; GL; IECEXKEM; KEMAATEX
Approvals	

Dimensions

Clamping range (nominal / min. / max.)
Depth x width x height

Note

Screw connection

2.5 / 0.5 / 2.5
114.3 / 6.1 / 112.5

Ordering data

Type	Qty.	Order No.
ACT20M-TCI-A0-S	1	1375480000

Note

Accessories

Note
DIN mounting rail, see accessories

Electrical connections

Terminal	ACT20M-TCI-A0-S		
	Input TC	Power supply	Output 1 V mA
1	CJC+ ^{1,2)}		
2	TC/CJC ^{1,2)}		
3	TC+		
4	CJC ^{1,2)}		
5		■	■
6		□	□
7		■	
8		□	

1) only 2) optional

■ = +

□ = -

Configuration

Temp.	Temperature range [°C]									
	TC J: -100...+1200 °C					TC K: -180...+1372 °C				
Min.	S2	Max.	S2	Max.	S2	Max.	S2	Max.	S2	Max.
-200		0				170				
-180	■	5				180	■			
-150	■	10				190	■			
-100	■	15				200	■			
-50	■	20				225	■			
-25	■	25				250	■			
-10	■	30				275	■			
-5	■	35				300	■			
0	■	40				325	■			
5	■	45				350	■			
10	■	50				375	■			
20	■	55				400	■			
25	■	60				450	■			
50	■	65				500	■			
100	■	70				550	■			
200	■	75				600	■			
		80				650	■			
		85				700	■			
		90				750	■			
		95				800	■			
		100				850	■			
		105				900	■			
		110				950	■			
		115				1000	■			
		120				1050	■			
		125				1100	■			
		130				1150	■			
		135				1200	■			
		140				1250	■			
		145				1300	■			
		150				1350	■			
		160				1372	■			

■ = On

ACT20M

Signal converters in 6 mm width

C

Temperature transducer

- Conversion of temperature signals, (thermocouple)
- Configuration via DIP switches

ACT-20M-TCI-A0-E-S

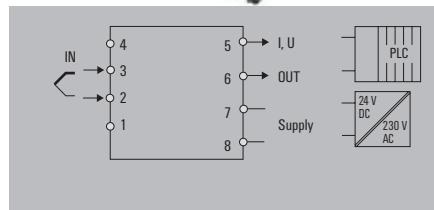
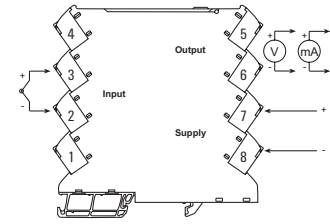

Technical data

Input	
Sensor	Thermocouple (type J, K)
Input measurement range	Thermocouple type J: -100...+1200°C, Thermocouple type K: -200...+1370°C
Temperature input range	Configurable, min. measurement range 50°C (TC)
Output	
Output current	adjustable, 0...20 mA, 4...20 mA
Output voltage	adjustable, 0...5 V, 0...10 V
load impedance current	≤ 600 Ω
load impedance voltage	≥ 10 kΩ
Sensor error detection	3.5 mA / 23 mA / none
General data	
Configuration	DIP switch
Supply voltage	24 V DC ± 30 %
Power consumption	0.7 W
Accuracy	absolute accuracy: < ±0.1 % of the measurement range, Basic accuracy: < ±1 °C
Galvanic isolation	Without isolation
Temperature coefficient	0,1 °C/°C, or, ≤0,01% des Messbereichs/°C
Step response time	≤ 30 ms, < 300 ms, Configurable
Ambient temperature	-25 °C...+70 °C
EMC standards	IEC 61326-1, NE 21
Approvals	
Approvals	cULus; DETNORVER; EAC; FMEEX; GL; IECEXKEM; KEMAATEX

Dimensions

Clamping range (nominal / min. / max.)	2.5 / 0.5 / 2.5
Depth x width x height	114.3 / 6.1 / 112.5

Note

Ordering data

Type	Qty.	Order No.
ACT20M-TCI-A0-E-S	1	1375500000

Note

Accessories

Note	DIN mounting rail, see accessories
------	------------------------------------

Electrical connections

Terminal	ACT20M-TCI-A0-E-S		
	Input TC	Power supply	Output 1
1	CJC+ ^{1,2)}		
2	TC/CJC ^{1,2)}		
3	TC+		
4	CJC ^{1,2)}		
5			■
6			□
7		■	
8		□	

1) only 2) optional
 ■ = +
 □ = -

Configuration

Temp.	Temperature range [°C]									
	TC J: -100...+1200 °C // TC K: -180...+1372 °C									
Min.	S2	Max.	S2	Max.	S2	Max.	S2	Max.	S2	Max.
-200		0				170				
-180	■	5				180	■			
-150	■	10				190	■			
-100	■	15				200	■	■		
-50	■	20				225	■	■		
-25	■	25				250	■	■		
-10	■	30				275	■	■		
-5	■	35				300	■	■		
0	■	40				325	■	■		
5	■	45				350	■	■		
10	■	50				375	■	■		
20	■	55				400	■	■		
25	■	60				450	■	■		
50	■	65				500	■	■		
100	■	70				550	■	■		
200	■	75				600	■	■		
		80				650	■	■		
		85				700	■	■		
		90				750	■	■		
		95				800	■	■		
		100				850	■	■		
		105				900	■	■		
		110				950	■	■		
		115				1000	■	■		
		120				1050	■	■		
		125				1100	■	■		
		130				1150	■	■		
		135				1200	■	■		
		140				1250	■	■		
		145				1300	■	■		
		150				1350	■	■		
		160				1372	■	■		

■ = On

CH20M rail bus

Quick and safe power supply through the DIN rail.

This customer-friendly infrastructure solution brings power, signals and data to the rail in a quick and reliable manner. The rail bus can replace the tedious individual wiring process with a flexible and uninterrupted system solution. As a result, the customer saves time and cost-especially if any module changes are needed later, as other adjacent modules are not disturbed. The uninterrupted system bus is securely integrated within the 35 mm standard mounting rail. Whether 7.5 mm or 15 mm high, the custom-fit rail profiles are easy to install on all TS 35 standard rails in accordance with DIN EN 607 15.

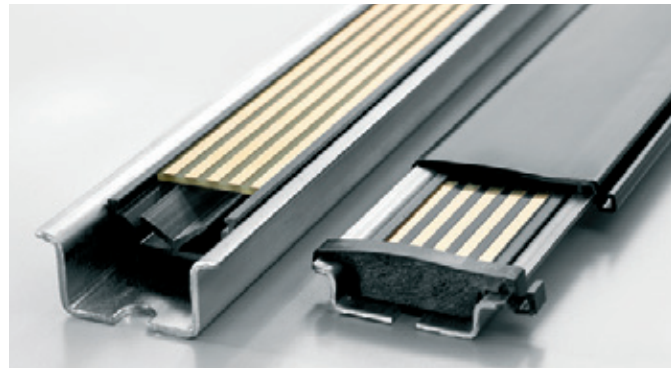

The resistant gold-plated contacts ensure a permanent and reliable contact. The ACT20M modules are simply snapped onto the mounting rail and are automatically in contact with the DIN rail bus.

The supply of 24 V DC to the power rail can be from any one of the auxiliary powered ACT20M modules, when that module is itself externally supplied. This allows the rail to power up to 8 other modules (approximately 400 mA). For powering additional ACT20Ms, a separate Feed-In module can be used.

The ACT20-Feed-In-Basic provides a simple and compact (6 mm width) power supply interface to the rail, for supplying up to 2.5 A (up to 50 x ACT20M modules).



The ACT20-Feed-In-Pro is a more powerful 22.5 mm wide solution. This takes 2 external 24 V DC inputs, and via internal diodes provides a redundant supply to the rail, and an alarm output in the case of input failure.

Rail bus accessories

CH20M BUS-PROFIL TS35x7.5/1000

Support section for bus circuit board



- Support section for TS 35 x 7.5
- Length: 250, 500 or 750 mm

Ordering data

Type	Qty.	Order No.
CH20M BUS-PROFIL TS35x7.5/250	10	1248150000
CH20M BUS-PROFIL TS35x7.5/500	10	1248160000
CH20M BUS-PROFIL TS35x7.5/750	5	1248170000

CH20M BUS-PROFIL TS35x15/1000

Support section for bus circuit board



- Support section for TS 35 x 15
- Length: 250, 500 or 750 mm

Ordering data

Type	Qty.	Order No.
CH20M BUS-PROFIL TS35x15/250	5	1248180000
CH20M BUS-PROFIL TS35x15/500	5	1248190000
CH20M BUS-PROFIL TS35x15/750	5	1248210000

CH20M BUS 4.50/05 AU/1000

Bus PCB



- Bus circuit board for use on TS 35 x 7.5 and TS 35 x 15
- Length: 250, 500 or 750 mm
- Five conductor paths, gold-plated
- Electrical rating: 63 V AC, 5 A/conductor path

Ordering data

Type	Qty.	Order No.
CH20M BUS 4.50/05 AU/250	10	1248220000
CH20M BUS 4.50/05 AU/500	10	1248230000
CH20M BUS 4.50/05 AU/750	5	1248240000

CH20M BUS-ADP TS35/1000

Cover plate



- Cover plate for DIN rail bus
- Length: 250, 500 or 750 mm

Ordering data

Type	Qty.	Order No.
CH20M BUS-ADP TS35/250	10	1248250000
CH20M BUS-ADP TS35/500	10	1248260000
CH20M BUS-ADP TS35/750	5	1248270000

CH20M BUS-AP LI TS35x7.5 & 15

End plate



- End plate for DIN rail bus
- Fits on TS 35 x 7.5 and TS 35 x 15
- left

Ordering data

Type	Qty.	Order No.
CH20M BUS-AP LI TS35x7.5 & 15	50	1193160000

CH20M BUS-AP RE TS35x7.5 & 15

End plate



- End plate for DIN rail bus
- Fits on TS 35 x 7.5 and TS 35 x 15
- right

Ordering data

Type	Qty.	Order No.
CH20M BUS-AP RE TS35x7.5 & 15	50	1193170000

SET CH20M BUS 250MM TS 35X15

Set

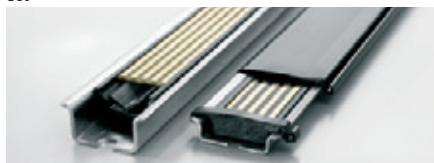

- SET consists of one each of
CH20M BUS 4.50/05 AU/250
CH20M BUS-ADP TS 35/250
CH20M BUS-AP LI TS 35X7.5 & 15
CH20M BUS-AP RE TS 35X7.5 & 15
CH20M BUS-PROFIL TS 35X15/250

Ordering data

Type	Qty.	Order No.
SET CH20M BUS 250MM TS 35X15	1	1335150000

SET CH20M BUS 250MM TS 35X7.5

Set

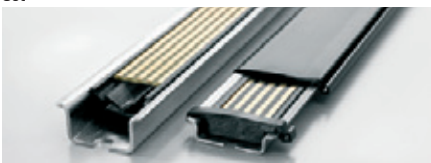

- SET consists of one each of
CH20M BUS 4.50/05 AU/250
CH20M BUS-ADP TS 35/250
CH20M BUS-AP LI TS 35X7.5 & 15
CH20M BUS-AP RE TS 35X7.5 & 15
CH20M BUS-PROFIL TS 35X7.5/250

Ordering data

Type	Qty.	Order No.
SET CH20M BUS 250MM TS 35X7.5	1	1335140000

TS 35x7.5 / TS 35x15

DIN rail

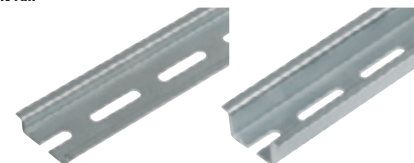

- DIN rail with slot
- Passivated galvanised steel

Ordering data

Type	Qty.	Order No.
TS 35x7.5/LL 1M/ST/ZN	10	0514510000
TS 35x15/LL 1M/ST/ZN	10	0236510000

Power-feed module for the CH20M DIN rail bus

4 A supply with backup supply and error analysis

The power-feed unit ACT20-FEED-IN-PRO-S supplies the devices on the CH20M DIN rail bus with 24 V DC. At the same time, the FEED-IN device reads the group error contact – optionally provided by the installed devices – from the CH20M rail bus and sends a message through the status relay to the external controller. Optionally, two power supplies can be connected as a primary and back-up, to create a redundant 24 V DC source. An installation in Zone 2 / Division 2 is also possible. Three LEDs show the status of the power supply and the error status.

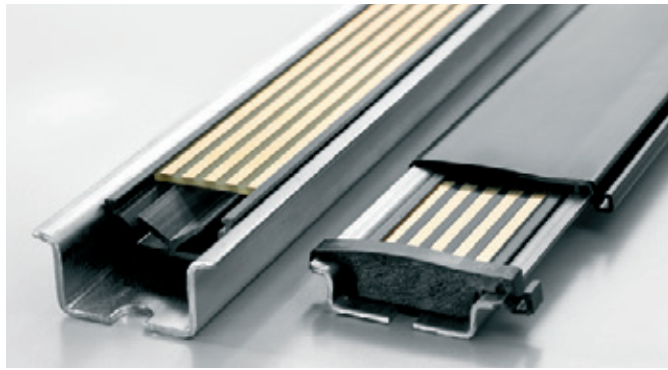

The FEED-IN-PRO can supply a maximum of 4 A to feed up to 120 devices mounted on a CH20M rail bus. Quick identification of errors on the DIN rail bus is through the internal status relay. The FEED-IN-PRO device immediately recognises and displays when a power supply has failed. The supply is then switched automatically to the redundant power supply.

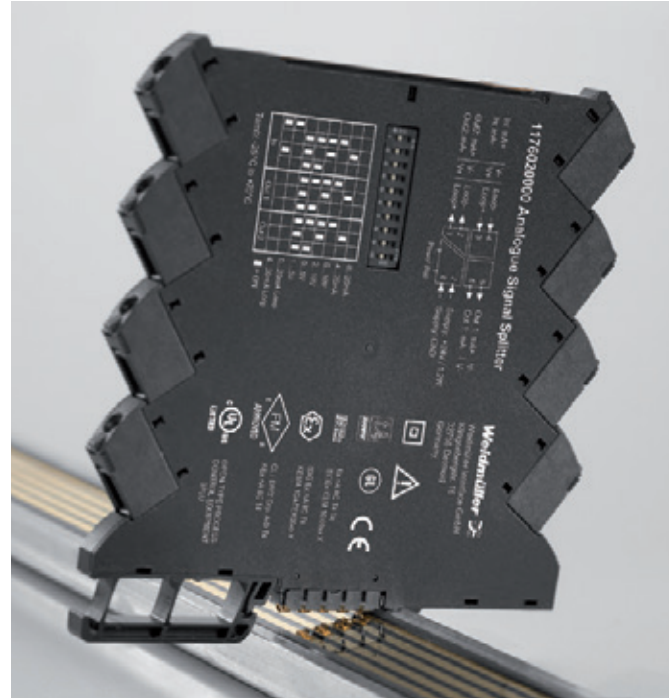

Weidmüller offers a compact and narrow 6 mm feed-in module as an alternative. This feeds the 24 V DC from its field terminals directly to the to the DIN rail bus. Up to 80 modules can be fed with a maximum available current of 2.5 A.

ACT20 power-feed unit

Signal converters in 6 mm width

C

ACT20 power-feed module

- Distributes the supply onto the busbar
- Compatible with Weidmüller CH20 DIN rail bus
- Optional connection for backup supply
- Approved for use in Ex-Zone 2 /Div. 2
- Monitoring of the supply voltage
- Alarm alerts via the status relay

ACT20-Feed-In-PRO-S

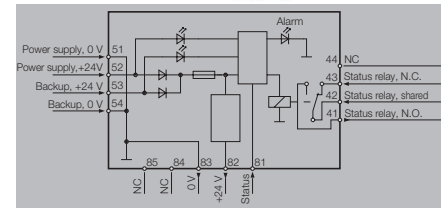

ACT20-Feed-In-BASIC-S

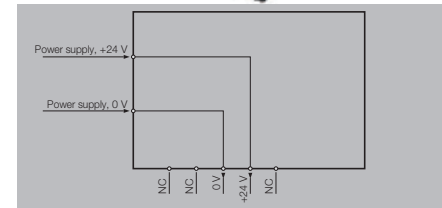

Technical data

Input	ACT20-Feed-In-PRO-S	ACT20-Feed-In-BASIC-S
Supply voltage	21.6...26.4 V DC	21.6...26.4 V DC
Input current	Max. 4 A	0.5...2.5 A DC
Trigger level for the power supply	21.6...26.4 V DC	
	Fault < 21 V DC	
Output, power supply		
Output voltage	Input voltage -0.5 V DC / 4 A	Corresponds to the input voltage
Output power	96 W	
Output current	Max. 4 A	Equivalent to input current
Output, status relay in safe zone		
Max. switching voltage, AC / Max. switching voltage, DC	250 V / 30 V	250 V / 30 V
Continuous current	2 A AC / DC	
AC power, max.	500 VA / 60 W	
General data		
Degree of efficiency	0,976	100 %
Ambient temperature	-20 °C...+60 °C	-25 °C...+70 °C
Power consumption	< 2 W	
Protection degree	IP 20	IP 20
Weight	140	70
Humidity	95 %, no condensation	95 %, no condensation
EMC standards	IEC 61326-1, NE 21	IEC 61326-1, NE 21
Approvals	cULus; DEKRAATEX; DETNORVER; EAC; FMEX; GOSTME25; IECEXDEK	cULus; DETNORVER; EAC; FMEX; GL; GOSTME25; IECEXKEM; KEMAATEX

Dimensions

Clamping range (nominal / min. / max.)
Length x width x height

Note

Screw connection

2.5 / 0.5 / 2.5
/ 22.5 / 117.2

Note

Screw connection

2.5 / 0.5 / 2.5
/ 6.1 / 112.5

Note

Ordering data

	Type	Qty.	Order No.	Type	Qty.	Order No.
Screw connection	ACT20-FEED-IN-PRO-S	1	8965500000	ACT20-FEED-IN-BASIC-S	1	1282490000

Note

Accessories

Note

DIN mounting rail, see Accessories

DIN mounting rail, see Accessories

Signal converter in a terminal format

The MCZ-SERIES signal converters have a slim terminal design and convert, isolate and monitor analogue signals. They have five tension clamp connections. The open side of the housing can be closed using a standard cover plate accessory. The housing has a low height of just 6.3 cm. It also accommodates a cross-connector for reducing the wiring of multiple module's 24 V and 0 V connections. Two WS10/6 markers can be used for labelling. These are available in MultiCard format and can be printed using Weidmüller's professional printing system.

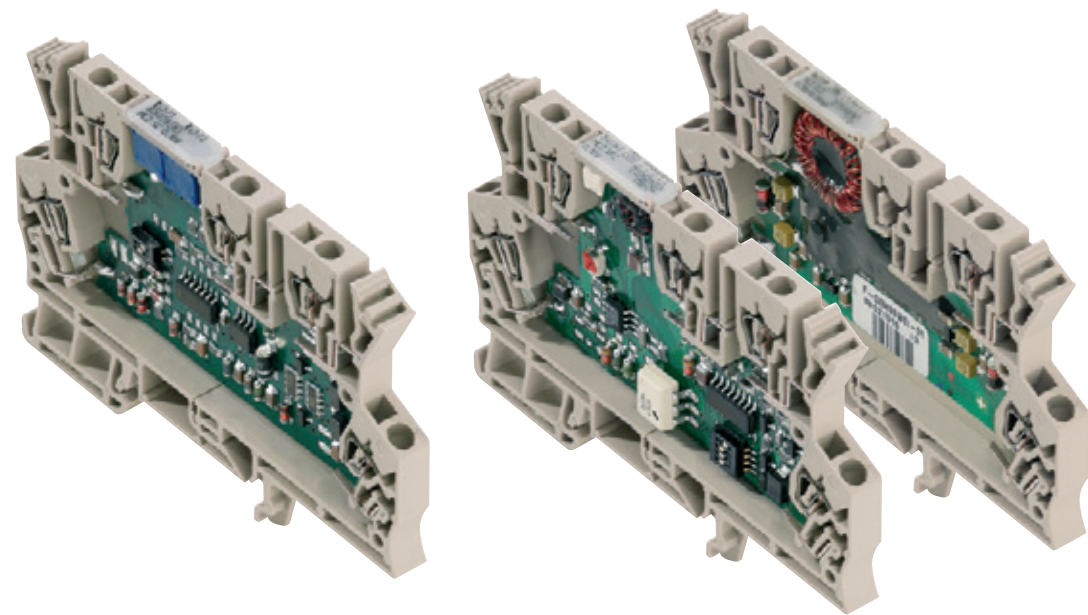

Selection table

Order No.	Product	Input						Output		Configuration	Auxiliary power	Rated voltage (V)	Isolation	Connection system	Special characteristics
		Amount 0...20mA	4...20mA	0...10V	RTD	Frequency	Sensor feed Width (mm)	Amount 0...20mA	Miscellaneous 4...20mA						
Selection table for analog signal converter MCZ series															
8425720000	MCZ PT100/3 CLP 0...100C	1			X		6	1	X		output loop		2-way	Z	Passive converter OLP
8483680000	MCZ PT100/3 CLP 0...120C	1			X		6	1	X		output loop		2-way	Z	Passive converter OLP
8604420000	MCZ PT100/3 CLP 0...150C	1			X		6	1	X		output loop		2-way	Z	Passive converter OLP
8473010000	MCZ PT100/3 CLP 0...200C	1			X		6	1	X		output loop		2-way	Z	Passive converter OLP
8473020000	MCZ PT100/3 CLP 0...300C	1			X		6	1	X		output loop		2-way	Z	Passive converter OLP
8473000000	MCZ PT100/3 CLP -50C...+150C	1			X		6	1	X		output loop		2-way	Z	Passive converter OLP
8604430000	MCZ PT100/3 CLP -40C...100C	1			X		6	1	X		output loop		2-way	Z	Passive converter OLP
8411190000	MCZ CCC 0-20mA/0-20mA	1	X	X			6	1	X	X	output loop		2-way	Z	Passive converter OLP
8260280000	MCZ SC 0-10V	1		X			6	2		Limit value transistor output potentiometer	24 V DC			Z	
8227350000	MCZ SC 0-20MA	1	X				6	2		Limit value transistor output potentiometer	24 V DC			Z	
8461480000	MCZ CFC 0-20MA	1	X				6	1		Frequency: 0...1/ 4/ 8/ 16 kHz DIP switch	24 V DC	100	2-way	Z	Frequency output configurable
8461470000	MCZ VFC 0-10V	1		X			6	1		Frequency: 0...1/ 4/ 8/ 16 kHz DIP switch	24 V DC	100	2-way	Z	Frequency output configurable

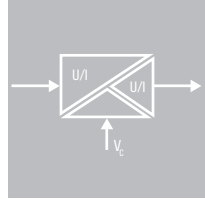

Security

Electrical isolation increases the safety of operations and reduces the risk of facility malfunctions.

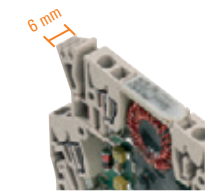

Saves space in the electrical cabinet



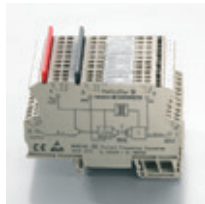

High product density (modules only 6 mm wide) reduces space taken on the DIN rail.



Simple wiring

The power supply can easily be bridged from one module to the next using pluggable cross-connections.

C

	DC/DC passive disconnecter
	PT100 /RTD signal converter
	Frequency signal converter
	Threshold monitoring

MCZ SERIES - DC/DC passive isolator**Input current loop feed**

- Passive isolators for galvanic isolation of 0/4...20 mA standard signals.
- The component draws power from the measurement signal and requires no additional auxiliary power
- Low energy consumption, pick-up current of < 100 μ A.
- 2-way isolation

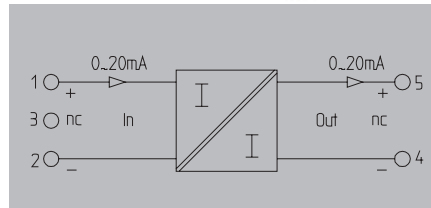
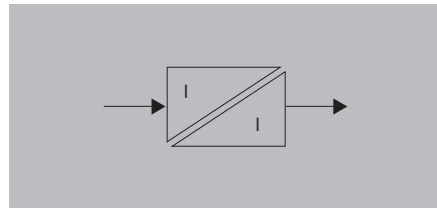
MCZ CCC / ILP**Technical data****Input**

Input voltage / Input current
Pick-up current
Voltage drop

/ 0...20 mA current loop
< 100 μ A
2.5...3 V at 20 mA

Output

Output voltage / Output current
Load impedance, voltage/current
Accuracy
Temperature coefficient
Cut-off frequency (-3 dB)

/ 0...20 mA, 4...20 mA
/ \leq 500 Ω
< 0.1 % of end value
 \leq 50 ppm/K of measured value at 0 Ω load resistance
100 Hz

General data

Configuration
Ambient temperature
Approvals

none
-25 $^{\circ}$ C...60 $^{\circ}$ C
CE, CSA, cURus, EAC

Insulation coordination

Standards
EMC standards
Insulation voltage

DIN EN 60529, DIN EN 61010-1
EN 61000-6

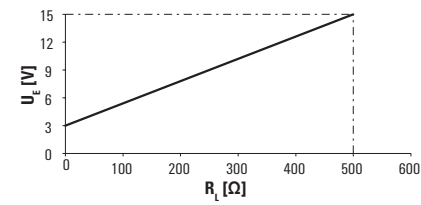
**Dimensions**

Clamping range (nominal / min. / max.)
Depth x width x height

Tension clamp connection

1.5 / 0.5 / 1.5
63.2 / 6 /

Note**Ordering data**

Tension-clamp connection

Type	Qty.	Order No.
MCZ CCC 0-20mA/0-20mA	10	8411190000

Note**Accessories****Note**

Cross-connectors for power supplies and markers: refer to accessories

MCZ-SERIES - PT100 / RTD signal converter

Signal converters in 6 mm width

RTD 2-/3-conductor converter

Output-loop powered

- RTD signal converter for galvanic isolation and conversion of PT100 signals
- The component draws power from the output circuit and requires no additional auxiliary power
- 2-way isolation

MCZ PT100/3 CLP / OLP

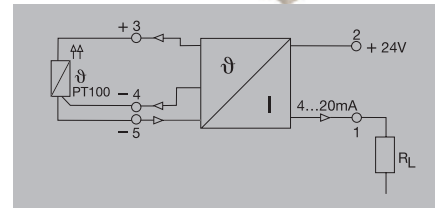
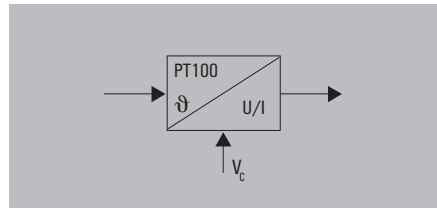

Technical data

Input
Sensor
Sensor supply
Output
Output current
Load impedance, voltage/current
General data
Configuration
Ambient temperature / Storage temperature
Accuracy
Approvals
Standards
EMC standards

PT100/2-/3-wire (in compliance with IEC 751)
0.8 mA / 9...30 V DC
4...20 mA (current loop) at 9...30V DC
/ ≤ 600 Ω
none
/ -25 °C...50 °C / -25 °C...85 °C
Typical 0.2%, max. 0.5% of FSR
CE, CSA, cURus, EAC
DIN EN 50178, DIN EN 61000-4-2
EN 61000-6

Dimensions
Clamping range (nominal / min. / max.)
Depth x width x height
Note

Tension clamp connection
1.5 / 0.5 / 1.5
63.2 / 6 /

Ordering data

-40...+100 °C	Tension-clamp connection
-50...+150 °C	Tension-clamp connection
0...100 °C	Tension-clamp connection
0...120 °C	Tension-clamp connection
0...150 °C	Tension-clamp connection
0...200 °C	Tension-clamp connection
0...300 °C	Tension-clamp connection
Note	

Type	Qty.	Order No.
MCZ PT100/3 CLP -40C...100C	10	8604430000
MCZ PT100/3 CLP -50C...+150C	10	8473000000
MCZ PT100/3 CLP 0...100C	10	8425720000
MCZ PT100/3 CLP 0...120C	10	8483680000
MCZ PT100/3 CLP 0...150C	10	8604420000
MCZ PT100/3 CLP 0...200C	10	8473010000
MCZ PT100/3 CLP 0...300C	10	8473020000

Accessories

Note

Cross-connectors for power supplies and markers: refer to accessories

MCZ SERIES - Frequency signal isolator

DC/f converter

The analogue input signal is converted into a configurable frequency signal. Thus analogue signals can be read by the PLC's counter inputs.

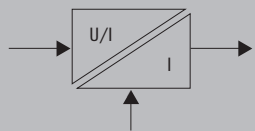

MCZ VFC

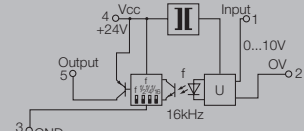

MCZ CFC

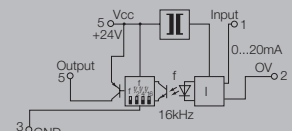

Technical data

Input	MCZ VFC	MCZ CFC
Input voltage / Input current	0...10 V /	/ 0...20 mA
Input resistance, voltage/current	100 k Ω /	/ 50 Ω
Voltage drop		1 V at 20 mA
Output		
Output frequency	0...1/ 4/ 8/ 16 kHz	0...1/ 4/ 8/ 16 kHz
Output level	PNP, U_b -0.7 V	PNP, U_b -0.7 V
Output current	max. 20 mA	max. 20 mA
Accuracy	0.2% of FSR	0.2% of FSR
Temperature coefficient	≤ 250 ppm/K	≤ 250 ppm/K
Status indicator	LED, pulsing	LED, pulsing
General data		
Configuration	DIP switch	DIP switch
Supply voltage	24 V DC $\pm 10\%$	24 V DC $\pm 10\%$
Current consumption	14 mA without load	14 mA without load
Current-carrying capacity of cross-connect.	≤ 20 A	≤ 20 A
Ambient temperature	0 °C...50 °C	0 °C...50 °C
Approvals	CE, EAC	CE, EAC
Insulation coordination		
Standards	DIN EN 50178	DIN EN 50178
EMC standards	EN 55011, EN 61000-6	EN 55011, EN 61000-6
Rated voltage	100 V	100 V
Impulse withstand voltage	1.5 kV	1.5 kV
Insulation voltage	1 kV DC	1 kV DC
Overvoltage category	III	III
Pollution degree	2	2
Clearance & creepage distances	≥ 1.5 mm	≥ 1.5 mm

Dimensions
Clamping range (nominal / min. / max.)
Depth x width x height
Note

Tension clamp connection
1.5 / 0.5 / 1.5
63.2 / 6 /
Note

Tension clamp connection
1.5 / 0.5 / 1.5
63.2 / 6 /
Note

Ordering data

Type	Qty.	Order No.	Type	Qty.	Order No.
MCZ VFC 0-10V	10	8461470000	MCZ CFC 0-20mA	10	8461480000

Note

Note

Note

Accessories

Note
Cross-connectors for power supplies and markers: refer to accessories

Note
Cross-connectors for power supplies and markers: refer to accessories

Note
Cross-connectors for power supplies and markers: refer to accessories

MCZ SERIES - Threshold monitoring

Transistor output

- 2 digital outputs
- Monitoring of upper and lower limit values
- 3 selectable input ranges: 300 mV...10 V, 30 mV...1 V, 10 mV...100 mV

MCZ SC 0...10 V

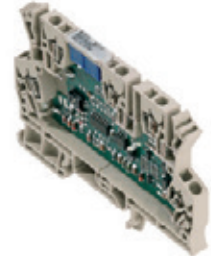

MCZ SC 0...20 mA



Signal converters in 6 mm width

C

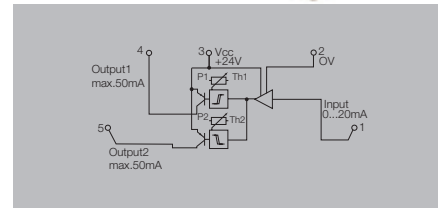
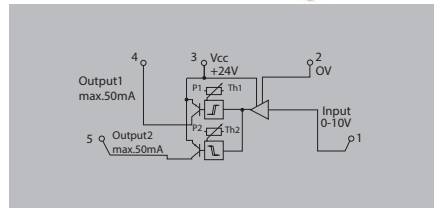
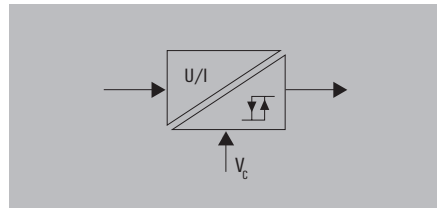

Technical data

Input	MCZ SC 0...10 V	MCZ SC 0...20 mA
Input voltage / Input current	0...10 V /	/ 0.5...20 mA
Input resistance, voltage/current	60 kΩ /	/ 50 Ω
Voltage drop		1 V
Output		
Contact assembly	double switch output PNP	double switch output PNP
Function	$U_{in} < U_{Th1}$: output 1 active / $U_{in} > U_{Th2}$: output 2 active	$I_{in} < I_{Th1}$: Output 1 active / $I_{in} > I_{Th2}$: Output 2 active
Switching thresholds	Via 2 potentiometers (12 turns)	Via 2 potentiometers (12 turns)
Hysteresis	1% of adjusted final value	1% of adjusted final value
Switching current	50 mA - per channel (voltage drop at transistor: < 1.2 V at 50 mA)	50 mA - per channel (voltage drop at transistor: < 1.2 V at 50 mA)
Step response time	< 250 μs (switching threshold at 90% of max. input signal; $R_i \leq 1$ kΩ)	< 250 μs (switching threshold at 90% of max. input signal; $R_i \leq 1$ kΩ)
Cut-off frequency (-3 dB)	100 Hz	100 Hz
Temperature coefficient	max. 250 ppm/K	max. 250 ppm/K
General data		
Configuration	Potentiometer	Potentiometer
Supply voltage	24 V DC ± 20 %	24 V DC ± 20 %
Ambient temperature	0 °C...50 °C	0 °C...50 °C
Approvals	CE, CSA, cURus, EAC	CE, CSA, cURus, EAC
Insulation coordination		
Standards	DIN EN 50178	DIN EN 50178
EMC standards	EN 55011, EN 61000-6	EN 55011, EN 61000-6

Dimensions

Clamping range (nominal / min. / max.)	1.5 / 0.5 / 1.5
Depth x width x height	63.2 / 6 /

Note

Tension clamp connection

Clamping range (nominal / min. / max.)	1.5 / 0.5 / 1.5
Depth x width x height	63.2 / 6 /

Note

Tension clamp connection

Clamping range (nominal / min. / max.)	1.5 / 0.5 / 1.5
Depth x width x height	63.2 / 6 /

Note

Ordering data

Type	Qty.	Order No.	Type	Qty.	Order No.
MCZ SC 0-10V	10	8260280000	MCZ SC 0-20MA	10	8227350000

Note

Accessories

Note	Cross-connectors for power supplies and markers: refer to accessories	Cross-connectors for power supplies and markers: refer to accessories
------	---	---

Signal converters

Contents

Signal converters

Signal converters	Universal signal converters – Overview	D.2
	ACT20C – Overview	D.4
	ACT20C – Network-compatible signal converter	D.7
	ACT20C – Station	D.8
	ACT20P – Overview	D.16
	ACT20P – Universal measurement converter	D.20
	ACT20P – Signal splitter	D.26
	ACT20P – Signal converter	D.27
	ACT20P – Limit value monitoring	D.29
	ACT20P – Current measuring transducer	D.32
	ACT20P – Bridge measuring transducer	D.34
	WAVESERIES – Overview	D.38
	WAVESERIES – Universal signal converters and trip amplifiers, configurable	D.40
	WAVESERIES – DC/DC 3-way isolator	D.44
	WAVESERIES – DC/DC 2-way isolator	D.54
	WAVESERIES – DC/DC passive isolator	D.56
	WAVESERIES – Temperature measuring transducer	D.60
	WAVESERIES – Frequency signal isolator/converter configurable	D.70
	WAVESERIES – Current measuring transducer	D.72
	WAVESERIES – Voltage measuring transducer	D.74
	Isolating converter for serial interfaces	D.76

D

Signal converters

Weidmüller analogue conditioners and monitoring modules are offered in touch-safe IP 20 housings and with space-saving DIN mounting.

This product line includes: passive and active isolation amplifiers for analogue current and voltage signals; measurement isolators for measuring temperatures, resistances, frequencies, AC/DC currents and voltages; and universally-configurable signal isolating converters with integrated threshold monitoring.

Weidmüller wide product range covers all the functions for isolating, converting and monitoring analogue signals. These products can therefore be used in practically all industrial measurement applications to safeguard the basic functionality between field signals and post-processing systems. A comprehensive line of accessories is also available for the analogue signal converter product line. These include pluggable cross-connectors, markers, and configuration adapters for the software-programmable products.

Features

- Can handle a variety of measurements
- Standard analogue signals on the output side
- Configurable options
- Stand-alone, pluggable connection mechanism – screw or tension clamp
- Tool-free installation
- Minimal commissioning needed - often with no calibration.
- Minimal wiring effort – with pluggable ZQV 2.5N cross-connector
- Excellent functionality
- Clear type designations makes selection easy
- High level galvanic isolation
- International approvals



	ACT20C
	ACT20P
	WAVESERIES

Your process requires the utmost attention

Our new ACT20C signal conditioners support you in achieving this

Many process parameters in your system are handled by your control system, which shows you the current status of your process. Even so, do you have a full overview of critical system states? And this at all times, at every location, and with the recent system history?

With the ACT20C, you receive accurate information on the status of the sensors, signal processing and cabling. Data can be called up and will depending on your individual communications infrastructure. This comprehensive overview allows you to accurately analyse errors and faults, and initiate targeted actions taken by system operators and maintenance personnel. By doing so, this technology contributes to ensuring reliable system operation.

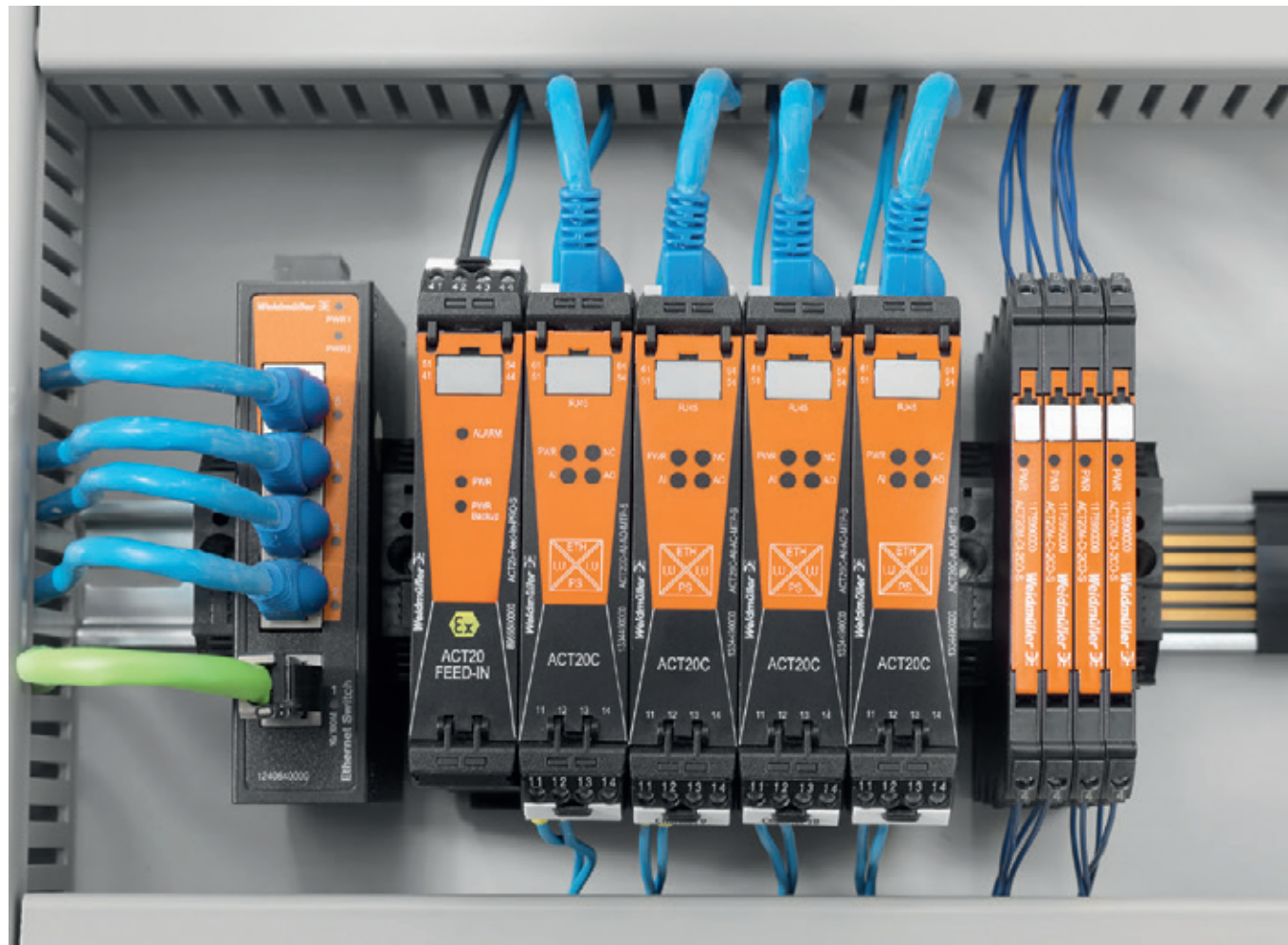

ACT20C signal conditioner with Ethernet interface

Comprehensive process transparency is provided by the transfer of diagnostics information, signals and data

You would like more process transparency for your systems. We support you with signal conditioners that supply you with precise information via our Ethernet interface. Let's connect.

To be able to control systems and processes optimally, you require a constant flow of information on the current states of individual applications, devices and functions.

Our ACT20C signal conditioner not only monitors the signal conversion, but also communicates precise information on device status, signals and data directly to connected computer and control systems.

Our Ethernet interface enables an event-controlled transfer of diagnostics information, which in turn supports the elimination of faults in, for example, plant operation.



D

Universal signal conversion

Can be used in a multitude of applications thanks to customer and application specific defined conversion methods with just one single module.

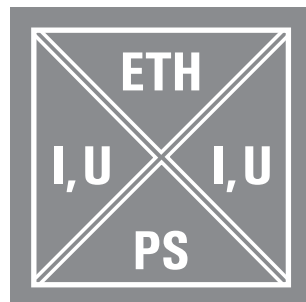

Simple operation and configuration

Software supported configuration allows a fast application of settings and simple operation.



Simple remote access

Continuous monitoring of device and system functions, simple and affordable integration of existing Ethernet networks.



Detailed analysis and presentation of core process parameters

The ACT20C supplies key parameters and historical data, independent of the location

Thanks to the ACT20C, Weidmüller is now the first to offer a solution which supplies you with extensive diagnostic and status information without the need to deal with the complexity of field bus systems.

The isolating converters are based on the proven, robust technology of transferring analogue signals to the DCS system. Various signal sources and field devices can be connected to the input side of the isolating converters. As a result of this, the ACT20C can be configured for the user-defined processing of current, voltage and transmitter signals. Access is accomplished via a service interface on

the front panel or via the Ethernet, and performance is ensured through the manufacturer-independent FDT/DTM software platform. To work with this platform, Weidmüller provides the WI-Manager universal FDT frame application.

Data collected in the ACT20C is made available over the Ethernet via Modbus TCP. Depending on the communications infrastructure, you can make this data available to your SCADA system within your network, and you can also access it via the Internet from any location using an industrial Ethernet router.

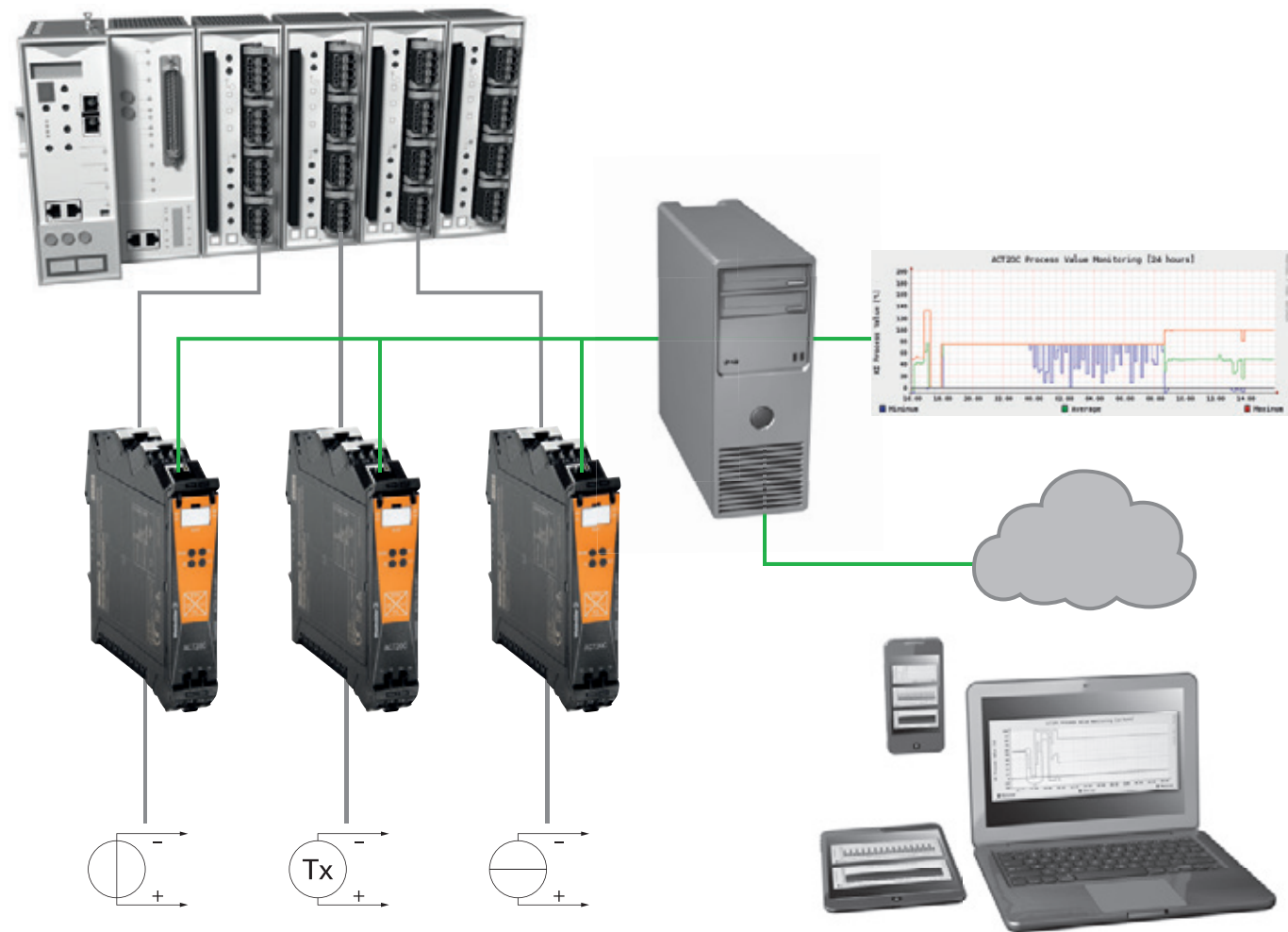

Network-ready signal converter for DC voltage and current signals

Network-compatible signal converter with Ethernet

- Scalable current or voltage input
- Current or voltage output
- Limit-value monitoring with parameterisation options
- Diagnostics on device status, signals and line faults via Modbus
- PC configuration with FDT/DTM software, download link at www.weidmueller.com

ACT20C-AI-AO-MTCP-S

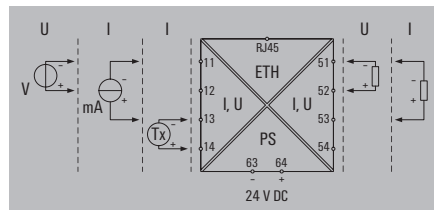

Technical data

Input

Input current 0...20 mA, 4...20 mA
 Input voltage 0...10 V
 Sensor supply > 17 V DC at 20 mA

Output

Output current 0...20 mA, 4...20 mA
 Output voltage 0...10 V
 load impedance current $\leq 500 \Omega$
 load impedance voltage $\geq 10 \text{ k}\Omega$

Signal processing

Transfer functions Linear, Inverse
 Limit-value monitoring Process alarms with adjustable delay and hysteresis
 Condition Monitoring Process value: sensor value, output value
 Diagnostics Device status, Short-circuit (input/output), Cable break (input/output), Overload (sensor/output)

General data

Supply voltage 24 V DC $\pm 25 \%$
 Power consumption $\leq 3.5 \text{ W}$
 Accuracy < 0.15% end value (+ 0.05% > 55°C), Current: 1 μA / 30 μA (+ 10 μA > 55°C), Voltage: 1 mV / 15 mV (+ 5 mV > 55°C)
 Temperature coefficient $\leq 0.01 \%$ / °C
 Ambient temperature (operational) -20 °C...70 °C
 Storage temperature -20 °C...85 °C
 Humidity 0...95 % (no condensation)
 Protection degree IP 20

Insulation coordination

Galvanic isolation 4-way isolator, between input / output / power supply / Ethernet
 Rated voltage / test voltage: input/output to output/input / supply / Ethernet interface 300 V_{rms} / 1.7 kV_{rms} on secondary electric circuits, reinforced insulation
 Rated voltage / test voltage: Ethernet interface to supply / functional earth to supply / Ethernet interface 31.2 VDC / 0.9 kV_{rms} on secondary electric circuits, basic insulation
 Rated voltage / test voltage: functional earth to input / output 300 V_{rms} / 1.1 kV_{rms} on secondary electric circuits, basic insulation

Pollution degree

Communication

RJ45 ports 10/100BaseT(X), auto negotiation
 Interface RJ45: female-female, Cat.5 to 100 MHz, Jack plug for CBX200
 Addressing DHCP or manual adjustment
 Protocol FDT/DTM, Modbus/TCP
 Configuration FDT/DTM (Ethernet or service interface)

Approvals

Standards DIN EN 61010-1, EN 61326-1:2006
 Recommendations Namur NE43, Namur NE44, Namur NE107

Dimensions

Clamping range (nominal / min. / max.) mm²
 Depth x width x height/Weight mm

Note

Screw connection/ RJ45 plug-in connector

2.5 mm²/0.5 mm²/2.5 mm²
 113.6/22.5/180 g

ACT20C – Network-compatible signal converter

Signal converters

D

Ordering data

Type	Qty.	Order No.
ACT20C-AI-AO-MTCP	1	1334490000

Take a preventative approach to monitoring plants and processes

ACT20C gateway conveys precise status information on your devices

Diagnostic and status information that's as comprehensive as possible and comes from all areas of an automation solution goes a long way in helping to optimise process control.

D With the ACT20C gateway and the communication-capable signal converters, for the first time ever we can obtain process data from the signal conversion level – regardless of the automation solution selected. An Ethernet interface enables simple access to the desired information. The data obtained in the ACT20C gateway is provided via Modbus TCP or OPC, or can be displayed directly in an FDT frame application.

The flexibility of the ACT20C gateway makes it easy for you to optimise your processes. Depending on the communication infrastructure, you can make this data available throughout your entire network or pass it on to your SCADA or maintenance system. The data can even be used from any location over the Internet via an Industrial Ethernet router.



The Ethernet interface enables events-driven transmission of diagnostic information. So, for example, measurement data about the pumps, which is continuously collected throughout their service life, provides information about their performance and operational status.

Your special advantages:

More transparency in your process automation

For the first time ever, extensive diagnostic and status information (which you can call up via the Ethernet interface) is available to you at status conversion level.

ACT20C - Station

All the process parameters at a glance
The status of devices, environmental conditions and functions is continually monitored over the Ethernet.



Simple commissioning, fast maintenance
The station concept with "Plug & Produce" and "Hot Swapping" makes installation and maintenance work faster and thus more efficient.

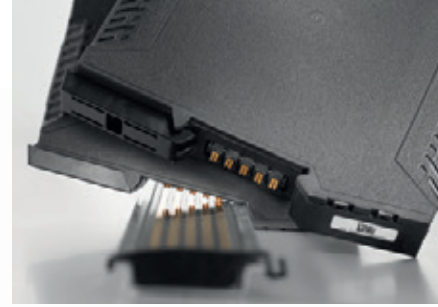

Signal converters

D

Extensive diagnostics concept
Support of fast and exact cause analysis according to NE107, NE43 and NE44.



Clever software configuration
The software configuration based on the FDT and FDT2 standards makes parameterisation, documentation and data backup easier.



ACT20C - Station

Condition monitoring

Preventative maintenance strategies using automation-independent information about operating conditions and process data for connected devices.



Multiple limit value monitoring

The main alarm and auxiliary alarm permit precise identification of all alarm situations.

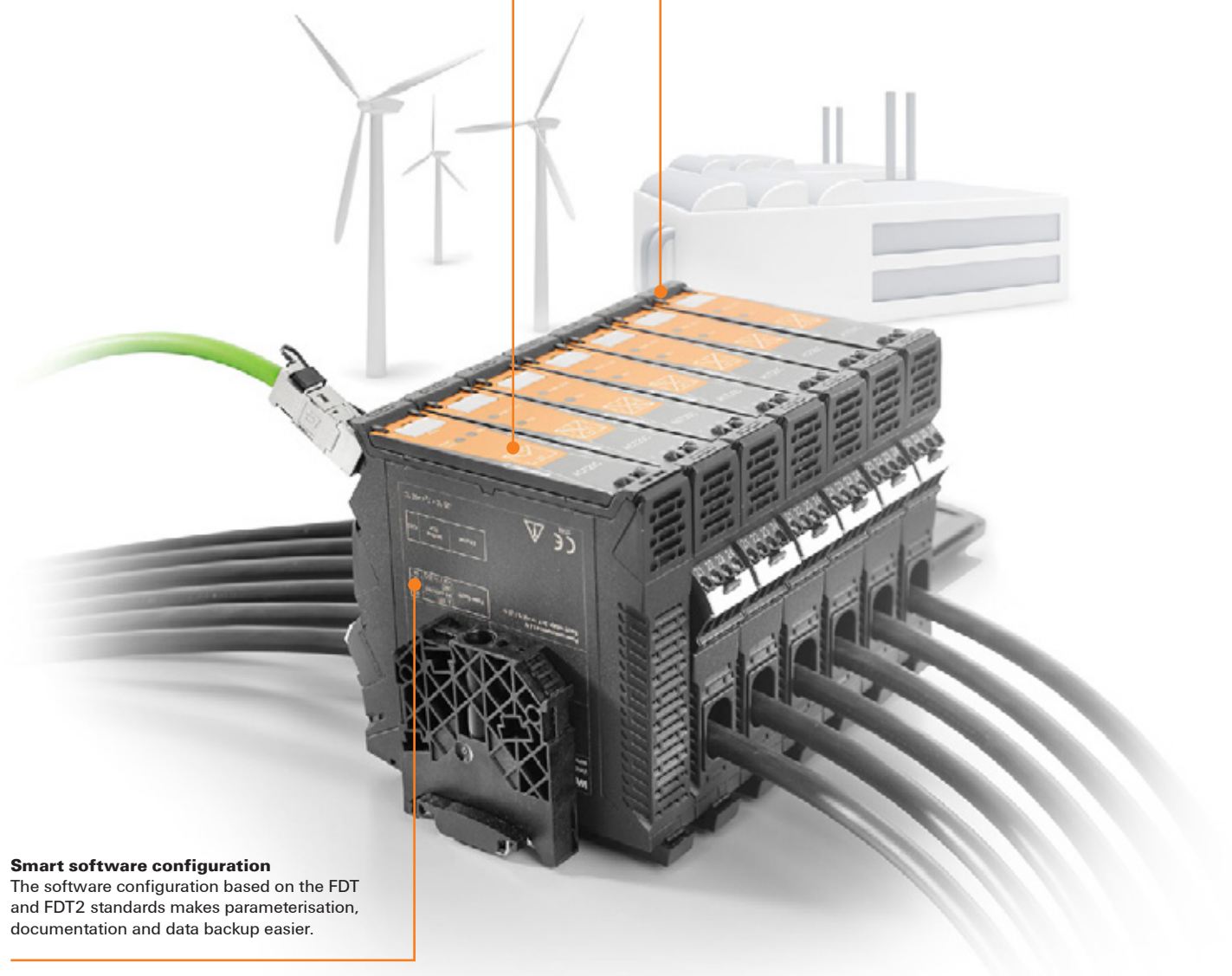
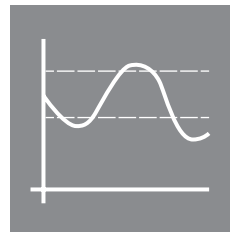

Smart software configuration

The software configuration based on the FDT and FDT2 standards makes parameterisation, documentation and data backup easier.



High process reliability

A galvanic four-way isolation and an impulse withstand voltage of 6.4 kV pursuant to IEC 61010-2-201 guarantee optimum fusing.

ACT20C - Station

Gateway for ACT20C station

- Access to all data from the devices connected to an ACT20C station
- RJ45 port with Ethernet TCP/IP
- Configuration by means of the FDT/DTM standard
- Station management with "Plug & Produce" and "Hot Swapping"

ACT20C-GTW-100-MTCP-S

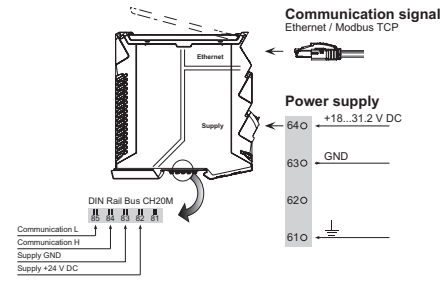
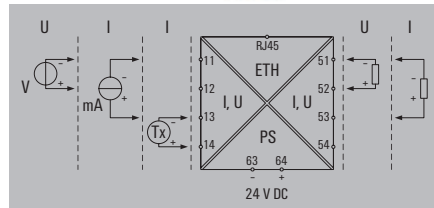

Technical data

Communication	
Addressing	DHCP or manual adjustment
Configuration	With FDT/DTM software, DHCP
RJ45 ports	10/100BaseT(X), auto negotiation
Interface	Ethernet 10/100 Base T, Jack plug for CBX200, Communication via CH20M rail bus with all current measuring transducers (ACT20C-CMT-x)
General data	
Configuration	With FDT/DTM software, DHCP
Power consumption, max.	2.2 W
Supply voltage	16,8 V...31,2 V
Insulation coordination	
Rated voltage / test voltage: Ethernet interface to supply / functional earth to supply / Ethernet interface	30 V AC RMS
Standards	IEC 61010-1, IEC 61010-2-201:2013, 1st Edition, IEC 61326-1:2012
Test voltage	1.1 kV
Impulse withstand voltage	0,5 kV (1.2/50 µs)
Pollution degree	2
Overvoltage category	II

Dimensions	
Clamping range (nominal / min. / max.)	2.5 / 0.5 / 2.5
Depth / Height / Width	113.6 / 117.2 / 22.5 mm
Note	

Ordering data

Type	Qty.	Order No.
ACT20C-GTW-100-MTCP-S	1	1510370000

Note	

Accessories

Note	

Signal converters

D

ACT20C – Station

Communicative current-measuring transducer

- Measurement and monitoring of AC/DC current
- Input and output ranges are adjustable
- Contact-free through-hole technology
- Relay output for limit value alarm with switching threshold, delay, hysteresis
- Monitoring/configuration via ACT20C station/gateway

ACT20C-CMT

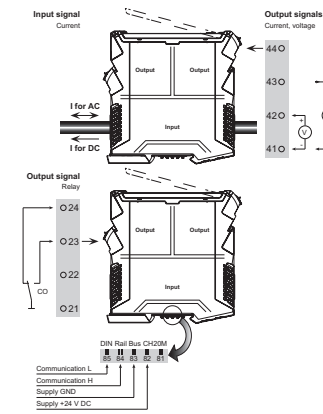
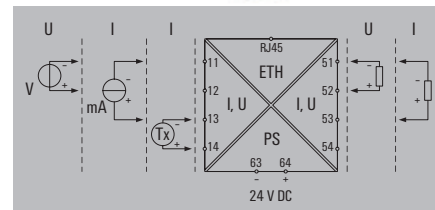

Technical data

Input	
Input measurement range	configurable, 0...5/10 A AC (RMS) or DC, 0...40/50/60 A AC (RMS) or DC
Input signal	Current-carrying cable in feed-through hole, Diameter 10.5 mm
Input frequency	AC: 15...700 Hz
Output (analogue)	
Output voltage [output analogue]	adjustable, 0...10 V, 2...10 V, 0...5 V, 1...5 V, -5...+5 V, -10...+10 V
Output current [output analogue]	adjustable, 0...20 mA, 4...20 mA, -20...+20 mA
Load resistance current [output analogue]	≤ 600 Ω
Load resistance voltage [output analogue]	≥ 10 kΩ
Output (digital)	
Type	Relay, 1 CO contact, Process alarms (4x) with hysteresis, with alarm delay (configurable) 0...180 s
Rated switching current	6 A
Max. switching voltage, AC	250 V
General data	
Configuration	With FDT/DTM software, via gateway (ACT20C-GTW-100-MTCP-S), Addressing via DIP switches
Step response time	< 300 ms
Temperature coefficient	≤ 200 ppm/K
Supply voltage	16,8 V...31,2 V, via the system bus
Insulation coordination	
Rated voltage	300 V AC _{rms}
EMC standards	IEC 61326-1
Galvanic isolation	4-way isolator, between input / output / supply / relay
Test voltage	4 kV
Impulse withstand voltage	6.4 kV (1.2/50 μs)
Pollution degree	2
Overvoltage category	III

Dimensions	
Clamping range (nominal / min. / max.)	2.5 / 0.5 / 2.5
Depth / Height / Width	113.6 / 117.2 / 22.5 mm

Ordering data			
Input measurement range 0...5/10 A	ACT20C-CMT-10-AO-RC-S	1	1510240000
Input measurement range 0...40/50/60 A	ACT20C-CMT-60-AO-RC-S	1	1510420000

Note	
-------------	--

Accessories	
Note	

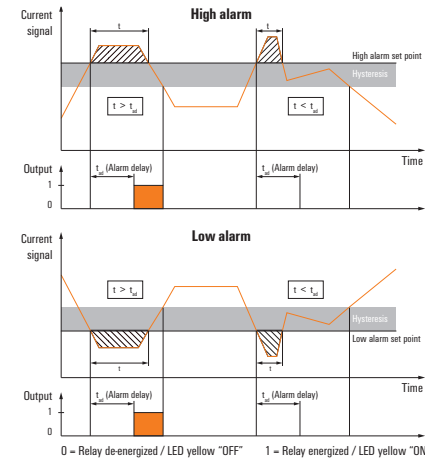

	DIP switch S1					
User address	1	2	3	4	5	6
2		■				
3	■					
4		■				
5			■			
6				■		
7	■					
8					■	
...						
16						■
...						
32						■
33	■					■

■ = ON

Bus termination terminal

- Electrical termination of the CH20M rail bus of an ACT20C station
- Acts as a mechanical end bracket at the same time

ACT20C-LBT-10

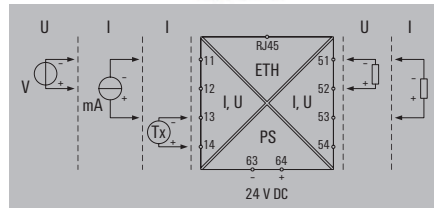

Technical data

Humidity	5...95 %, no condensation
Ambient temperature	-25 °C...+60 °C
General data	
Tightening torque, min.	1.2 Nm
Tightening torque, max.	2.4 Nm
Mounting rail	TS 35

Dimensions	
Depth / Width / Height	63 / 20.6 / 56

Note	
-------------	--

Ordering data

Type	Qty.	Order No.
ACT20CLBT-10	1	1510340000

Note	
-------------	--

Accessories

Note	
-------------	--

CH20M rail bus

Quick and safe power supply through the DIN rail.

This customer-friendly infrastructure solution brings power, signals and data to the rail in a quick and reliable manner. The rail bus can replace the tedious individual wiring process with a flexible and uninterrupted system solution. As a result, the customer saves time and cost-especially if any module changes are needed later, as other adjacent modules are not disturbed. The uninterrupted system bus is securely integrated within the 35 mm standard mounting rail. Whether 7.5 mm or 15 mm high, the custom-fit rail profiles are easy to install on all TS 35 standard rails in accordance with DIN EN 607 15.

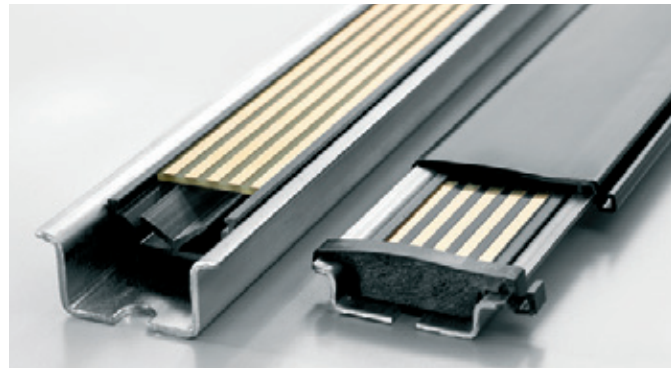

The resistant gold-plated contacts ensure a permanent and reliable contact. The ACT20M modules are simply snapped onto the mounting rail and are automatically in contact with the DIN rail bus.

The supply of 24 V DC to the power rail can be from any one of the auxiliary powered ACT20M modules, when that module is itself externally supplied. This allows the rail to power up to 8 other modules (approximately 400 mA). For powering additional ACT20Ms, a separate Feed-In module can be used.

The ACT20-Feed-In-Basic provides a simple and compact (6 mm width) power supply interface to the rail, for supplying up to 2.5 A (up to 50 x ACT20M modules).

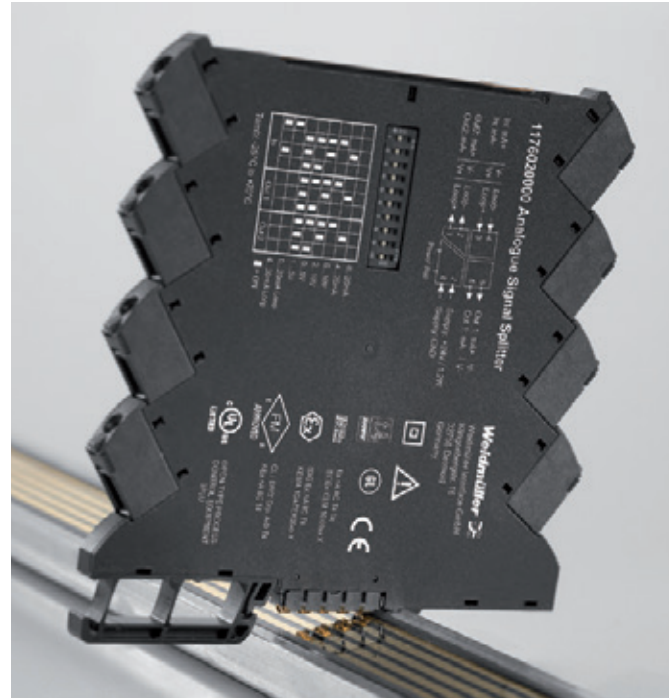

The ACT20-Feed-In-Pro is a more powerful 22.5 mm wide solution. This takes 2 external 24 V DC inputs, and via internal diodes provides a redundant supply to the rail, and an alarm output in the case of input failure.

Rail bus accessories

CH20M BUS-PROFIL TS35x7.5/1000

Support section for bus circuit board



- Support section for TS 35 x 7.5
- Length: 250, 500 or 750 mm

Ordering data

Type	Qty.	Order No.
CH20M BUS-PROFIL TS35x7.5/250	10	1248150000
CH20M BUS-PROFIL TS35x7.5/500	10	1248160000
CH20M BUS-PROFIL TS35x7.5/750	5	1248170000

CH20M BUS-PROFIL TS35x15/1000

Support section for bus circuit board



- Support section for TS 35 x 15
- Length: 250, 500 or 750 mm

Ordering data

Type	Qty.	Order No.
CH20M BUS-PROFIL TS35x15/250	5	1248180000
CH20M BUS-PROFIL TS35x15/500	5	1248190000
CH20M BUS-PROFIL TS35x15/750	5	1248210000

CH20M BUS 4.50/05 AU/1000

Bus PCB



- Bus circuit board for use on TS 35 x 7.5 and TS 35 x 15
- Length: 250, 500 or 750 mm
- Five conductor paths, gold-plated
- Electrical rating: 63 V AC, 5 A/conductor path

Ordering data

Type	Qty.	Order No.
CH20M BUS 4.50/05 AU/250	10	1248220000
CH20M BUS 4.50/05 AU/500	10	1248230000
CH20M BUS 4.50/05 AU/750	5	1248240000

CH20M BUS-ADP TS35/1000

Cover plate



- Cover plate for DIN rail bus
- Length: 250, 500 or 750 mm

Ordering data

Type	Qty.	Order No.
CH20M BUS-ADP TS35/250	10	1248250000
CH20M BUS-ADP TS35/500	10	1248260000
CH20M BUS-ADP TS35/750	5	1248270000

CH20M BUS-AP LI TS35x7.5 & 15

End plate



- End plate for DIN rail bus
- Fits on TS 35 x 7.5 and TS 35 x 15
- left

Ordering data

Type	Qty.	Order No.
CH20M BUS-AP LI TS35x7.5 & 15	50	1193160000

CH20M BUS-AP RE TS35x7.5 & 15

End plate



- End plate for DIN rail bus
- Fits on TS 35 x 7.5 and TS 35 x 15
- right

Ordering data

Type	Qty.	Order No.
CH20M BUS-AP RE TS35x7.5 & 15	50	1193170000

SET CH20M BUS 250MM TS 35X15

Set

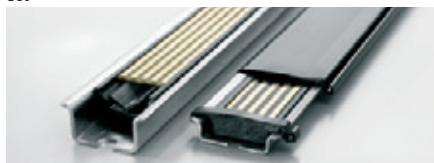

- SET consists of one each of
CH20M BUS 4.50/05 AU/250
CH20M BUS-ADP TS 35/250
CH20M BUS-AP LI TS 35X7.5 & 15
CH20M BUS-AP RE TS 35X7.5 & 15
CH20M BUS-PROFIL TS 35X15/250

Ordering data

Type	Qty.	Order No.
SET CH20M BUS 250MM TS 35X15	1	1335150000

SET CH20M BUS 250MM TS 35X7.5

Set

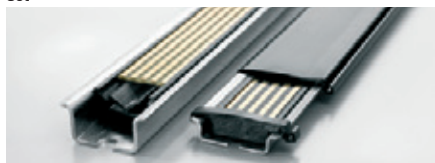

- SET consists of one each of
CH20M BUS 4.50/05 AU/250
CH20M BUS-ADP TS 35/250
CH20M BUS-AP LI TS 35X7.5 & 15
CH20M BUS-AP RE TS 35X7.5 & 15
CH20M BUS-PROFIL TS 35X7.5/250

Ordering data

Type	Qty.	Order No.
SET CH20M BUS 250MM TS 35X7.5	1	1335140000

TS 35x7.5 / TS 35x15

DIN rail

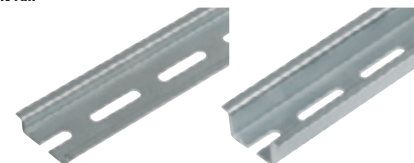

- DIN rail with slot
- Passivated galvanised steel

Ordering data

Type	Qty.	Order No.
TS 35x7.5/LL 1M/ST/ZN	10	0514510000
TS 35x15/LL 1M/ST/ZN	10	0236510000

Your systems work with analogue current signals

ACT20P signal converters efficiently tackle signal conditioning and isolation

Your systems and processes are controlled using analogue current signals. Our signal isolation converters are the reliable and efficient solution to signal conditioning and galvanic isolation of current signals. Let's connect.

Temperature, pressure, weight or distance: your system's sensors pass on a wide range of analogue signals. During this process, undesirable transients may occur, causing faults and damaging your controls' inputs.

Our ACT20P signal converter delivers reliable protection of controls and remote I/O inputs against transients and voltage peaks. It also adapts a multitude of signal variants to standard signals, in addition to being space-saving and efficient.

Its properties make the ACT20P signal converter a low-cost universal solution to all tasks involving the analogue isolation and conversion of current signals.



Fault-free recording of measured data in water management

During the final step of water purification, quality values are checked. To this end, the signals emitted by the measurement devices are transferred over several hundred metres from the switching box on the last setting basin to the plant control room. There, they are recorded, analysed and stored. For a smooth measurement data recording process, our signal isolation converters filter out all of the faults and transients according to the latest provisions set forth in EN 61010.

ACT20P - Overview

Can be integrated in HART® communication

Signal converters are suitable for HART®, transparent communication.



Reliable connection

Individually customisable protection against mismatching.



Rapid device replacement

Practical release lever for simple removal of the female connector.



More space in the cabinet

Two channels measure a mere 12.5 mm wide.



Variants for different applications

The range of products is rounded off by the intrinsically safe ACT20X signal converter and the high-performance ACT20M signal converter, which is just 6 mm across.



Signal converters

D

ACT20P - Selection table

Selection table

Order No.	Product	Width (mm)	Input										Output				Configuration	
			Amount	0...20mA	4...20mA	0...10V	0...5V	TC	RTD	Frequency	Sensor feed	Miscellaneous	Amount	0...20mA	4...20mA	0...10V		Relais
Signal converter																		
7760054114	ACT20P-CI-CO	12.5	1	X	X						X	2-/3-wire transmitter	1	X	X			
7760054115	ACT20P-CI-2CO	12.5	1	X	X						X	2-/3-wire transmitter	2	X	X			
7760054117	ACT20P-2CI-2CO-12	12.5	2	X									2	X	X			
Bridge-measuring transducer																		
1067250000	ACT20P-BRIDGE-S	22.5	1								X	4-,6-, wire strain gauges	1	X	X	X	Reset button (TARE)	
Universal measuring converter																		
1481970000	ACT20P-PRO DCDC H-S	12.5	1	X	X	X	X				X	± 100 mA, ± 300 V	1	X	X	X	± 10 V, ± 20 mA	Display, DIP switch
1453210000	ACT20P-UI-AO-DO-LP-S	12.5	1	X	X	X	X	X	X		X	± 25 mA, ± 5 A DC, ± 28 V DC, ± 300 V DC, 300 V AC	1	X			Output Loop powered, NPN output, Limit value	Software
1477420000	ACT20P-AI-AO-DC-S	12.5	1	X	X	X	X				X	0...11V, 0...22mA	1	X	X	X	0...11V, 0...22mA	DIP switch, Button, LED
Limit value monitoring																		
7940045760	ACT20P-UI-2RCO-DC-S	22.5	1	X	X	X	X	X	X	X	X	± 25 mA, ± 5 A DC, ± 30 V DC, ± 300 V DC, potentiometer, resistance	1			X	2 x Limit value relay outputs	Software, Display
AC/DC Signal measuring transducer																		
1510470000	ACT20P-CMT-10-AO-RC-S	22.5	1									0...10 A AC/DC	1	X	X	X	± 10 V, ± 20 mA, Limit value relays	DIP switch, potentiometer
1510540000	ACT20P-CMT-30-AO-RC-S	22.5	1									0...30 A AC/DC	1	X	X	X	± 10 V, ± 20 mA, Limit value relays	DIP switch, potentiometer
1510440000	ACT20P-CMT-60-AO-RC-S	22.5	1									0...60 A AC/DC	1	X	X	X	± 10 V, ± 20 mA, Limit value relays	DIP switch, potentiometer



Reliable connection

Individually configurable protection against mismatching with release lever

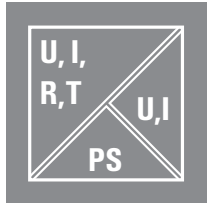

High level of galvanic isolation

The galvanic isolation of 2 kV (300 V rated voltage) ensures high process reliability







Simple signal conditioning

Devices configured for converting standard sensor signals to standard DC signals.

D

Auxiliary power	Rated voltage (V)	Isolation	Connection system	Special characteristics
24 V DC	300	3-way	S	HART®- transparent
24 V DC	300	3-way	S	HART®- transparent
24 V DC	300	3-way	S	HART®- transparent
10...60 V DC	300	3-way	S	
24 V - 230 V AC/DC	600	3-way	S	aktiv or passiv output
output loop	300	3-way	S	Output Loop powered
12...60 V DC	300	3-way	S	
9...60 V DC	300	3-way	S	
24 V DC	300	3-way	S	Through hole current converter
24 V DC	300	3-way	S	Through hole current converter
24 V DC	300	3-way	S	Through hole current converter

	Universal measurement converter
	Signal splitter
	Signal converter
	Limit value monitoring
	Measuring transducer

ACT20P - Universal measurement converter

High process reliability

Thanks to the high level of galvanic isolation amounting to 4 kV (600 V rated voltage), secure operation is guaranteed.

4 kV

Flexible supply

The wide supply range from 24 V UC to 230 V UC opens up a diverse range of applications for the ACT20P Pro DCDC II.

Precise data recording

Measurement data is converted and transmitted with an accuracy level of 0.05 %.

Universal solution

Due to the multitude of adjustable measurement ranges from ± 300 V DC or ± 100 mA DC, the input range can be deployed in an extremely broad spectrum of applications.



ACT20P – Universal measurement converter

Universal DC isolation amplifier

- Universally configurable input and output for voltage/ current
- Active or passive output
- Universal voltage supply 24...230 V AC/DC
- 3-way isolation
- Convenient configuration on the device with DIP switches or by means of clear-text display + buttons, without reference source.

ACT20P-PRO DCDC II-S

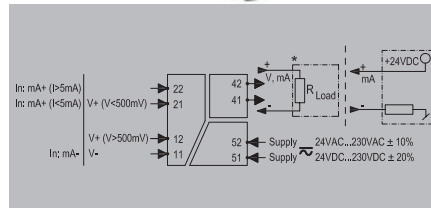

Technical data

Input	
Input voltage	configurable, ± 20 mV... ± 300 V
Input current	configurable, ± 0.1 mA... ± 100 mA
Input resistance, current	< 5 mA: approx. 100Ω ; > 5 mA: approx. 5Ω
Input resistance, voltage	approx. $1 \text{ M}\Omega$
Output	
Output voltage	adjustable, 0 ... ± 10 V
Output current	adjustable, 0 ... ± 20 mA
load impedance voltage	$\geq 1 \text{ k}\Omega$
load impedance current	$\leq 600 \Omega$
Offset voltage	< 10 mV
Cut-off frequency (-3 dB)	$> 10 \text{ kHz}$ / $< 10 \text{ Hz}$
General data	
Galvanic isolation	3-way isolator, between input / output / supply / relay
Accuracy	< 0.05 % of measuring range
Temperature coefficient	$\leq 0,01$ % des Messbereichs $^{\circ}\text{C}$
Configuration	DIP switch, or via display and push-buttons
Power consumption	≤ 2.3 W
Step response time	≤ 50 ms, $\leq 50 \mu\text{s}$
Supply voltage	24...230 V DC ± 20 %, 24...230 V AC ± 10 % @ 48...62 Hz
Insulation coordination	
Rated voltage	600 V
Standards	EN 60079-0, EN 60079-15, EN 61010-1:2011, EN 61140, EN 61326-1, UL 61010-1, SN29500 for MTBF
Insulation voltage	4 kV _{eff} input / output / power supply
Impulse withstand voltage	5 kV (1.2/50 μs)
Pollution degree	2
Overvoltage category	II

Dimensions	Screw connection
Clamping range (nominal / min. / max.)	2.5 / 0.5 / 2.5
Length x width x height	/ 12.5 / 117.2

Note	

Ordering data

Type	Qty.	Order No.
ACT20P-PRO DCDC II-S	1	1481970000

Note	

Accessories

Note	

Signal converters

D

All-purpose inputs combined with output loop supply

ACT20 signal converters are equipped for diverse applications

When it comes to recording analogue measured values, compliance with safety regulations and maximum precision are basic prerequisites for industrial plants. Basic security functions, such as switching units on and off, monitoring actuators or controlling temperature and pressure, require the support of high-precision signal converters.

With our ACT20X and ACT20P products, we are providing you with universal devices that will reliably isolate and convert signals from intrinsically safe or safe zones. Thanks to the integrated output current loop, the modules do not require any additional external power supply and can also be easily used in remote control boxes. Integrated in an enclosure that measures a mere 12.5 mm wide, the signal converters take up very little space on the DIN rail.

The latest addition to our ACT20X series is characterised by high precision and compliance with all the safety requirements for use in Ex zones 0, 1 and 2. Also, the ACT20P ITX+ offers extended input properties, such as measurement of +/-300 V AC/DC voltages and currents of up to +/-5 A DC. It even features a digital output for indicating limit values.



The great advantage of a signal converter in applications involving direct, on-site recording of measured values from temperature and pressure sensors is that it can be used independently of the power supply

Your special advantages:

Predestined for field use

The combination of all-purpose input and output loop supply makes the ACT20X a unique product solution for the process industry and plant manufacture. But the advantages of this solution really do come into their own especially when the device is used e.g. in remote cabinets in the mining industry – both above and below ground – or in overburden materials handling.

ACT20P – Universal measurement converter

Universal converter with digital output

- Independent of external supply thanks to output loop-powered supply
- All-purpose usage thanks to versatile input functions
- Simple software configuration
- Digital output for versatile limit value setting

ACT20P-UI-A0-DO-LP-S

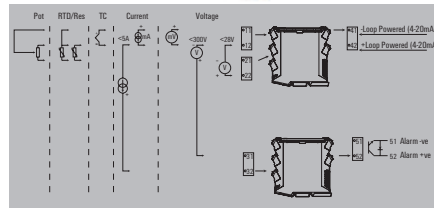

Technical data

Input	
Sensor	PT100 / 2-/3-/4-wire, PT1000/2-/3-/4-wire, PT200, N120, Thermocouples: B, E, J, K, L, N, R, S, T, U, Potentiometer
Input voltage	configurable, ± 300 V DC (min. measurement range 100 V), 0...300 V AC (min. measurement range 100 V)
Input current	configurable, ± 5 A DC (min. measurement range 0.5 A)
Potentiometer	1.2...500 kΩ
Output	
Type	Output-loop powered
Output current	4...20 mA, 20...4 mA, Current loop
load impedance current	typ. 700 Ω @ 24 V DC
Output (digital)	
Type	Transistor, open collector
Rated switching voltage	≤ 30 V DC
Rated switching current	20 mA
General data	
Galvanic isolation	2-way isolator, between input/output
Accuracy	< 0.1 % of measuring range
Configuration	With FDT/DTM software
Step response time	450 ms
Supply voltage	Output loop powered, (10...45 V)
Insulation coordination	
Rated voltage	300 V _{eff}
Standards	DIN EN 61326-1, DIN EN 61010-1
Insulation voltage	3.51 kV between input and output
Impulse withstand voltage	4 kV (1.2/50 μs)
Pollution degree	2
Overvoltage category	III

Dimensions	Screw connection
Clamping range (nominal / min. / max.)	2.5 / 0.5 / 2.5
Depth / Width / Height	113.6 / 12.5 / 119.2 mm

Note	
-------------	--

Ordering data

Type	Qty.	Order No.
ACT20P-UI-A0-DO-LP-S	1	1453210000

Note	CBX200 USB configuration adapter - 8978580000
-------------	---

Accessories

Note	
-------------	--

Signal converters

D

ACT20P - Universal measurement converter

Simple operation

The intuitive connection system with release levers makes it easier to maintain the device and to detach lines.



Versatile application options

The ACT20P-WavePak functions over a large temperature range and can be used reliably in an extremely wide range of application areas.

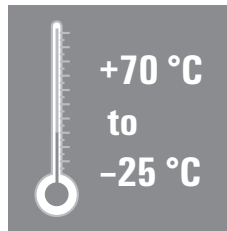

High process reliability

The high level of galvanic isolation of 4 kV at 300 V rated voltage guarantees safe operation.

4 kV

ACT20P – Universal measurement converter

Signal converter

- Isolation and conversion of DC signals
- 24 V - sensor supply
- Configuration via DIP switch/button
- Supply 12-60 V DC
- 3-way isolation

ACT20P-AI-AO-DC-S

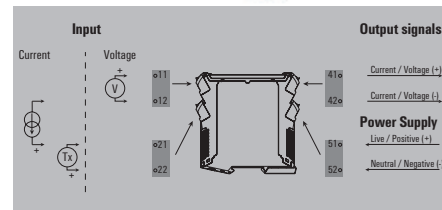

Technical data

Input	
Input voltage	configurable, 0...11 V (min. measurement range 2V)
Input current	configurable, 0...22 mA (min. measurement range 4 mA)
Input resistance, current	100 Ω
Input resistance, voltage	≥ 1 MΩ
Sensor supply	24 V DC
Output	
Output voltage	adjustable, 0...11 V, min. output range 2V
Output current	adjustable, 0...22 mA, min. output range 4 mA
load impedance voltage	≥ 500 kΩ
load impedance current	≤ 1kΩ
Offset voltage	≤ 20 mV
General data	
Galvanic isolation	3-way isolator, between input / output / supply
Linearity	< ± 0.1 % of signal range, Typ. ± 0.05 % of signal range
Temperature coefficient	< 0.05 % / °C
Configuration	DIP switch, Keys and LED display
Step response time	350 ms
Supply voltage	12...60 V DC
Insulation coordination	
Standards	IEC 61326-1:2012, UL 61010-1:2012, 3rd Edition
EMC standards	IEC 61326-1
Insulation voltage	2 kV inputs / outputs
Impulse withstand voltage	4 kV (1.2/50 μs)
Overvoltage category	III

Dimensions	Screw connection: pluggable
Clamping range (nominal / min. / max.)	1.5 / 1 / 2.5
Depth / Height / Width	113.7 / 117.2 / 12.5 mm

Note	

Ordering data

Type	Qty.	Order No.
ACT20P-AI-AO-DC-S	1	1477420000

Note	

Accessories

Note	

Signal converters

D

ACT20P – Signal splitter

Signal splitter

- Isolation and splitting of DC signals
- Passive transmitter or active current input
- 3-way isolation
- HART[®] - transparent

ACT20P-CI-2CO

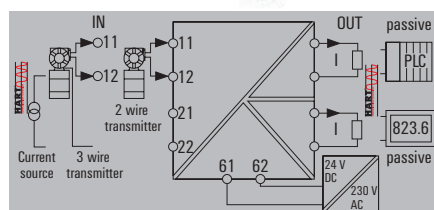

Technical data

Input	
Input signal	2-/3-wire transmitter, HART digital signal
Input current	0...20 mA, 4...20mA
Voltage drop, current input	≥ 17V @20mA
Voltage drop	≤ 1 V
Output	
Output current	0...20 mA, 4...20 mA
load impedance current	< 300 Ω
General data	
Configuration	none
Supply voltage	20...30 V DC
Accuracy	< 0.1 % of end value
Step response time	≤ 0,5 ms
Temperature coefficient	80 ppm/K
Ambient temperature	
Insulation coordination	
EMC standards	EN 61010-1:2011, UL 61010-1, EN 61326-1
Insulation voltage	2 kV inputs / outputs / power supply
Test voltage	300 V
Impulse withstand voltage	4 kV (1.2/50 μs)
Pollution degree	2
Overvoltage category	III

Dimensions	Screw connection
Clamping range (nominal / min. / max.)	2.5 / 0.5 / 2.5
Depth x width x height	113.7 / 12.5 / 117.2
Note	

Ordering data

Type	Qty.	Order No.
ACT20P-CI-2CO	1	7760054115

Note	
------	--

Accessories

Note	
------	--

ACT20P - Signal converter

Signal converters

Signal converter

- Isolation of DC signals
- Passive transmitter or active current input
- 3-way isolation
- HART® - transparent

ACT20P-CI-CO

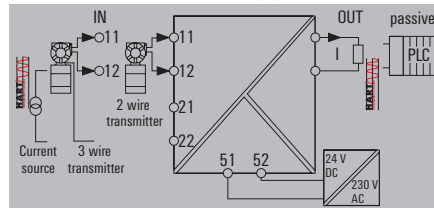

Technical data

Input	
Input signal	2-/3-wire transmitter, HART digital signal
Input current	0...20 mA, 4...20mA
Voltage drop, current input	≥ 17V @20mA
Voltage drop	≤ 1 V
Output	
Output current	0...20 mA, 4...20 mA
load impedance current	≤ 550 Ω
General data	
Configuration	none
Supply voltage	20...30 V DC
Accuracy	< 0.1 % of end value
Step response time	≤ 0,5 ms
Current consumption	≤60 mA (24V power supply, 20mA output)
Temperature coefficient	80 ppm/K
Ambient temperature	
Insulation coordination	
EMC standards	EN 61010-1:2011, UL 61010-1, EN 61326-1
Insulation voltage	2 kV inputs / outputs / power supply
Test voltage	300 V
Impulse withstand voltage	4 kV (1.2/50 μs)
Pollution degree	2
Overvoltage category	III

Dimensions	Screw connection
Clamping range (nominal / min. / max.)	2.5 / 0.5 / 2.5
Depth x width x height	113.7 / 12.5 / 117.2
Note	

Ordering data	Type	Qty.	Order No.
	ACT20P-CI-CO	1	7760054114

Note	
------	--

Accessories	
Note	

D

ACT20P - Signal converter

Signal converter

- Isolation of DC signals
- Passive input
- 2 channels in one module
- 3-way isolation
- HART® - transparent

ACT20P-2CI-2CO-12

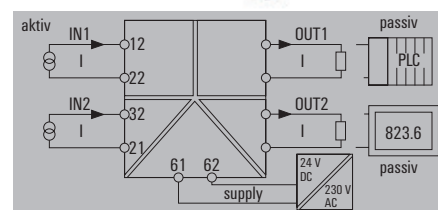

Technical data

Input	
Input current	0...20 mA, 4...20mA
Voltage drop	≤ 1 V
Output	
Output current	0...20 mA, 4...20 mA
load impedance current	< 300 Ω, per channel
General data	
Configuration	none
Supply voltage	20...30 V DC
Accuracy	< 0.1 % of end value
Step response time	≤ 0,5 ms
Temperature coefficient	80 ppm/K
Ambient temperature	
Insulation coordination	
EMC standards	EN 61010-1:2011, UL 61010-1, EN 61326-1
Insulation voltage	2 kV inputs / outputs / power supply
Test voltage	300 V
Impulse withstand voltage	4 kV (1.2/50 μs)
Pollution degree	2
Overvoltage category	III

Dimensions	Screw connection
Clamping range (nominal / min. / max.)	2.5 / 0.5 / 2.5
Depth x width x height	113.7 / 12.5 / 117.2
Note	

Ordering data

Type	Qty.	Order No.
ACT20P-2CI-2CO-12	1	7760054117

Note	

Accessories

Note	

Limit monitoring with simple configuration

ACT20P identifies even the smallest deviations

Reliable monitoring of parameters such as pressure, flow and temperature plays an important role, especially for power applications and in the process industry. In this regard, individual specifications and standards define the limits to be observed for smooth process flows.

Our ACT20P trip amplifier enables a precise monitoring solution to be set up for your process signals. Easily configured via FDT/DTM software or also directly on the device, the universal module can be used in many ways. The universal input range as well as the robust design support a wide temperature range.

The trip amplifier is characterised by high reproducibility and reliability. Thanks to its wide range of alarm functions, it can identify and accurately report even the smallest deviations.



D

Effective control of threshold limits for the process industry - our trip amplifiers offer an especially precise solution that responds rapidly and correctly in the event of deviations

Your special advantages:

Simple configuration

Use the buttons on the 7-segment display to configure the ACT20P monitoring module extremely quickly. The manufacturer-independent FDT/DTM software also facilitates configuration.



Universal input

The universal input range covers DC currents up to 5 A and voltages up to 300 V, 2/3-wire RTD, thermocouples, resistors and potentiometers to 500 kΩ.

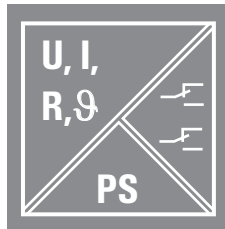

Numerous alarm functions

Window alarm, alarm delay, wireline break detection and hysteresis are just some of the features with which the trip amplifier provides the best conditions for each process requirement.



Configured directly at the device
A 7-segment display and LEDs support the direct configuration by push buttons and potentiometer.



High temperature stability
Thanks to the extended temperature range from -20 °C to +70 °C, the robust monitoring module can be used in any environment.

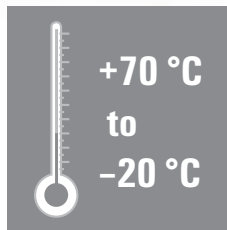

ACT20P - Limit value monitoring

Universal limit-value monitoring

- Universally configurable input for temperature, voltage, current, potentiometer, resistance
- 2 independent relay outputs with multiple limit value functions: window alarm, upper/lower limits, hysteresis, delay, etc.
- Configuration on the device from 7-segment display or via FDT/DTM software
- External power supply 9...60 V DC

ACT20P-UI-2RCO-DC-S

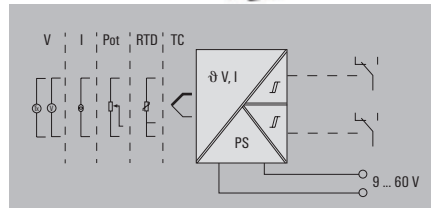

Technical data

Input	
Sensor	Thermocouples: B, E, J, K, L, N, R, S, T, U, PT100/2-/3-wire, PT200, PT1000, N120, Cu 10, Potentiometer: 1.2 k Ω - 500 k Ω , Resistance: 0 - 1.5 k Ω , Resistance: 0 - 12 k Ω , Resistance: 0 - 750 Ω
Input measurement range	configurable, Thermocouple type J -100...+1200 $^{\circ}$ C, Thermocouple type K -200...+1370 $^{\circ}$ C, PT100 -200...+850 $^{\circ}$ C
Input voltage	configurable, \pm 150 mV DC, \pm 600mV DC, \pm 30 V DC, \pm 300 V DC
Input current	configurable, \pm 25 mA DC, \pm 5 A DC
Output (digital)	
Type	2 CO contacts
Rated switching current	200mA @ 110Vdc, 6A @ 24Vdc / 240Vac
General data	
Galvanic isolation	3-way isolator, Input to supply / Alarm 1 / Alarm 2
Accuracy	< 0.05 % of measuring range
Temperature coefficient	< 0.02 $^{\circ}$ C of measuring range / $^{\circ}$ C
Configuration	With FDT/DTM software, or via 7-segment display, push-buttons and rotary encoder on the device itself
Power consumption	\leq 3.5 W
Step response time	450 ms
Supply voltage	9...60 V DC
Ambient temperature (operational)	-20 $^{\circ}$ C...70 $^{\circ}$ C
Insulation coordination	
Rated voltage	300 V _{eff}
Standards	DIN EN 61326-1, DIN EN 61010-1
Insulation voltage	3 kV
Impulse withstand voltage	3 kV (1.2/50 μ s)
Pollution degree	2
Overvoltage category	III

Dimensions	Screw connection
Clamping range (nominal / min. / max.)	2.5 / 0.5 / 2.5
Depth / Width / Height	113.6 / 22.5 / 117.2

Note	
-------------	--

Ordering data

Type	Qty.	Order No.
ACT20P-UI-2RCO-DC-S	1	7940045760

Note	
-------------	--

Accessories

Note	CBX200 USB configuration adapter - 8978580000
-------------	---

Signal converters

D

ACT20P - Current measuring transducer

Simple and quick configuration

DIP switches and potentiometers are located on the front, which means they're quickly accessible even when installed.

**Precise measured values**

The real-value effective procedure allows you to record the connected load's real power consumption, so you can reliably identify when levels exceed or fall below the nominal current.

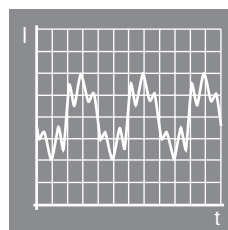
**Easy to install**

The asymmetrical cable bushing makes it easier to feed through the power cable and permits precise measurement on an extremely small space.

**High process reliability**

Reliable function thanks to a galvanic four-way isolation and an impulse withstand voltage of 6.4 kV according to IEC 61010-2-201

6.4 kV

Current-measuring transducer

- Measuring and monitoring of AC/DC current
- Input/output electrically isolated
- Input and output ranges are adjustable
- Contact-free through-hole technology
- Relay output for limit value alarm with switching threshold, delay, hysteresis

ACT20P-CMT

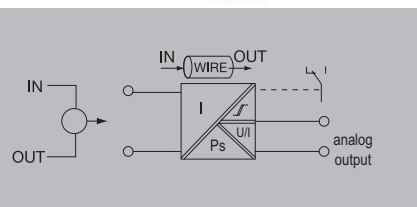

Technical data

Input	
Input measurement range	configurable, 0...1/5/10 A AC (RMS) or DC
Input signal	Current-carrying cable in feed-through hole, Diameter 10.5 mm
Input frequency	AC: 15...700 Hz
Output (analogue)	
Output voltage [output analogue]	adjustable, 0...10 V, 2...10 V, 0...5 V, 1...5 V, -5...+5 V, -10...+10 V
Output current [output analogue]	adjustable, 0...20 mA, 4...20 mA, -20...+20 mA
Load resistance voltage [output analogue]	≥ 10 kΩ
Load resistance current [output analogue]	≤ 600 Ω
Output (digital)	
Type	Relay, 1 CO contact, Open or closed-circuit principle, with alarm delay time (configurable) 0 s / 2 s / 5 s / 10 s
Rated switching current	6 A
Max. switching voltage, AC	250 V
General data	
Galvanic isolation	4-way isolator, between input / output / supply / relay
Accuracy	< 0.5 % of end value
Configuration	DIP switch and potentiometer, for thresholds (overcurrent / undercurrent), delay and hysteresis
Step response time	< 220 ms (10...90 %)
Temperature coefficient	≤ 200 ppm/K
Supply voltage	18...30 V DC
Insulation coordination	
Rated voltage	300 V AC _{rms}
Standards	IEC 61010-1:2010, 3rd Edition, IEC 61010-2:2013, 1st Edition, EN 61326-1
Impulse withstand voltage	6.4 kV (1.2/50 μs)
Test voltage	4 kV
Pollution degree	2
Overvoltage category	III

Dimensions

Clamping range (nominal / min. / max.)	1,5 / 0,5 / 2,5
--	-----------------

Note

Ordering data

Type	Qty.	Order No.
ACT20P-CMT-10-A0-RC-S	1	15 104 70000
ACT20P-CMT-30-A0-RC-S	1	15 105 40000
ACT20P-CMT-60-A0-RC-S	1	15 104 40000
ACT20P-CMT-60-RC-S	1	15 103 90000

Note

Accessories

Note	
-------------	--

ACT20P - Current measuring transducer

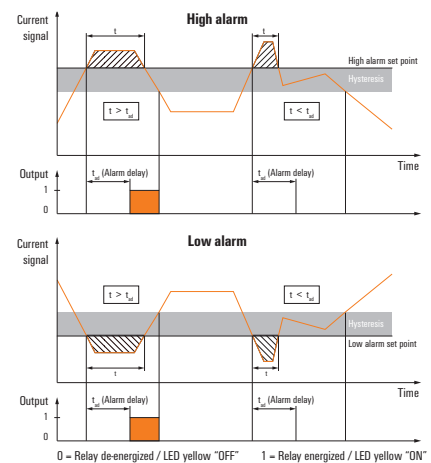
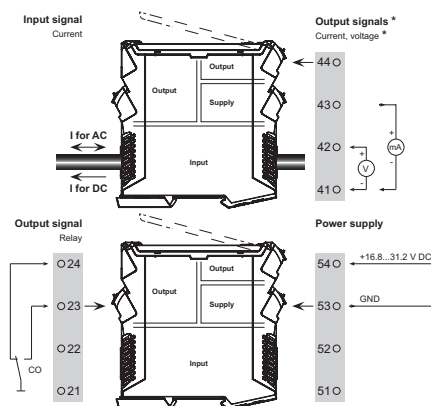

DIP switch S1		DIP switch S2	
Current input range	1 2 3 4 5 6 7 8	Output range	1 2 3 4 5 6 7 8
0...5 A	<input type="checkbox"/>	0...10 V	<input type="checkbox"/>
0...10 A	<input checked="" type="checkbox"/>	2...10 V	<input type="checkbox"/>
0...25 A	<input type="checkbox"/>	0...5 V	<input type="checkbox"/>
0...50 A	<input type="checkbox"/>	1...5 V	<input checked="" type="checkbox"/>
0...60 A	<input type="checkbox"/>	-5...+5 V	<input type="checkbox"/>
0...80 A	<input type="checkbox"/>	-10...+10 V	<input type="checkbox"/>
0...50 A	<input checked="" type="checkbox"/>	0...20 mA	<input type="checkbox"/>
0...30 A	<input type="checkbox"/>	4...20 mA	<input type="checkbox"/>
0...20 A	<input type="checkbox"/>	20...+20 mA	<input type="checkbox"/>
Measuring method	1 2 3 4 5 6 7 8	Alarm relay action	1 2 3 4 5 6 7 8
True RMS	<input type="checkbox"/>	Escalated	<input type="checkbox"/>
Arithmetic average	<input checked="" type="checkbox"/>	De-energized	<input checked="" type="checkbox"/>
Alarm delay time	1 2 3 4 5 6 7 8	Alarm hysteresis	1 2 3 4 5 6 7 8
0 s	<input type="checkbox"/>	5 %	<input type="checkbox"/>
2 s	<input type="checkbox"/>	10 %	<input type="checkbox"/>
5 s	<input checked="" type="checkbox"/>	Alarm type	1 2 3 4 5 6 7 8
10 s	<input type="checkbox"/>	High alarm	<input type="checkbox"/>
Measuring range monitoring	1 2 3 4 5 6 7 8	Low alarm	<input checked="" type="checkbox"/>
No	<input type="checkbox"/>	Output error action	1 2 3 4 5 6 7 8
Yes	<input checked="" type="checkbox"/>	Up-scale	<input type="checkbox"/>
Output error action	1 2 3 4 5 6 7 8	Down-scale	<input checked="" type="checkbox"/>
Up-scale	<input type="checkbox"/>	Transfer function	1 2 3 4 5 6 7 8
Down-scale	<input checked="" type="checkbox"/>	Normal	<input type="checkbox"/>
Transfer function	1 2 3 4 5 6 7 8	Inverse	<input checked="" type="checkbox"/>

- = ON
- 1) ACT20P-CMT-10-A0-RC-S
- 2) ACT20P-CMT-30-A0-RC-S
- 3) ACT20P-CMT-60-A0-RC-S, ACT20P-CMT-60-RC-S

D

Signal converters

ACT20P Strain gauge transmitter

The ACT20P Bridge converts load cell/strain gauge measurement signals to standard analogue signals.

The ACT20P family offers the customer precise and functional signal converters in a compact design. The ACT20P Bridge is the first product from this new line of signal converters.

Load cells, with integral strain gauges, are used for weighing and load measurements throughout factory and process automation, in such applications as batch and recipe control, silo contents for granular products, bag weighing, engine strain measurements, and tank level.

The strain gauges, within the load cell, are film resistors in a measurement bridge network, which deform with load changes and create a varying millivolt output from the bridge. The ACT20P Bridge reads these signals and converts them to a standard signal 0(4) – 20 mA or 0 – 10 V.

The high input to output isolation provided protects the control PLC against signal line interference. A digital input representing the “empty” condition of the container (tare function) is a standard feature which zeroes the output of the ACT20P Bridge.

Features

- Adjust to load cells using push button
- Easy tare function using the integrated control input
- Intelligent pluggable connection method
The release lever simplifies maintenance and enables the connection to be unplugged without any wire damage.
- Integrated captive coding with the unique “auto-set” function



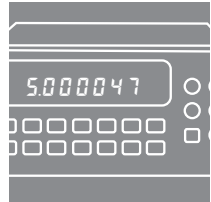

Exact measurement

The input with 6-conductor connection and very high accuracy (0.05 % of the measurement range) enables precise signal processing.



Conversion

Conversion of the bridge voltage in standardised analogue signals.



Tare calibration

Simple calibration of the empty (tare) weight can be done on-site by using the button under the front plate or with an external connection via a PLC output.



On-site calibration

Simple and reliable calibration on-site. The ACT20P Bridge is adjusted to the different load cells by means of a push button behind the hinged panel.



Protection

Protection against noise from the field. The 3-way isolation separates the input, the voltage supply and the output with 5.7 kV isolation voltage.

D

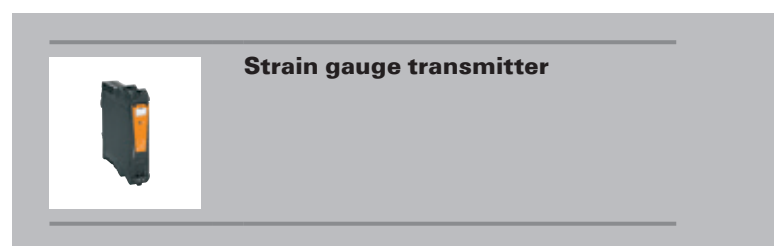

ACT20P Bridge measuring transducer

Bridge measuring transducer for reading from load cells

General

The ACT20P Bridge is a DIN rail mounted, signal conditioner for industrial measuring bridges. It provides a precise excitation voltage for the bridge, and converts the input measurement to an isolated current/voltage signal. Bridge measuring transducers are used for various measurements like weight, force, tension, pressure, torque, and deflection.

Bridge excitation supply

Voltage sense connections are provided so that the excitation voltage can be measured at the bridge. Known as 'remote sensing' this method compensates for cabling and contact resistance errors. It is recommended for all new installations or where an upgrade is possible. Remote sensing wiring requires three twisted pairs.

TARE adjustment

The installed strain gauge is normally subjected to an initial load independent of the measurement taken. The TARE connection allows you to correct for this initial loading by operating a switch. Alternatively there is a button on the front of the unit (under the front cover) that performs the same function. Press for two seconds to correct for the initial load (the 'CAL HI' LED will light for one second).

Gauge factor

Every strain gauge has a 'gauge factor' which gives the output voltage at full-scale for a one volt excitation voltage (given in mV/V). You multiply this by the bridge excitation voltage to get the output voltage when the gauge is fully loaded. For example, a load cell with 10 V excitation and 2 mV/V gauge factor will give 20 mV when fully loaded. The meaning of a 20 mV output depends on the type of the strain gauge. If it was designed to measure 0-1000 Kg then 20 mV indicates a 1000 Kg load.

Setup

The ACT20P Bridge has internal switch settings that determine the excitation voltage (5 V or 10 V) and Input range limits. Select the appropriate settings from the table below. Once you have set the DIP switches, you simply calibrate the unit to the input and output range for your application.

Calibration

There are three options for calibrating the ACT20P Bridge:

- Kalibrierung über einen Messbrückensimulators (Bench calibrate using a bridge simulator (if you know the gauge factor)
- Calibrate on-site by loading the actual installed strain gauge
- Bench calibrates using a mV source (if you know the gauge factor).

For more information please read the manual from the web page: www.weidmueller.com

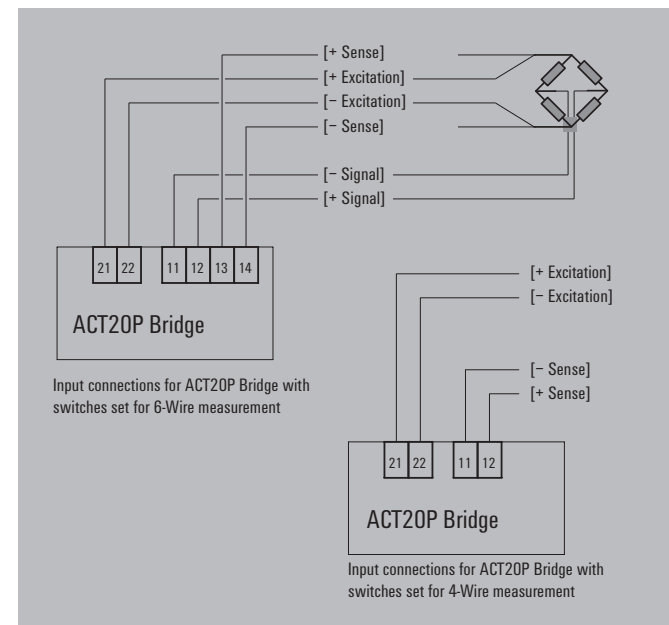

ACT20P – Bridge measuring transducer

Signal converters

D

Configurable

Bridge measuring transducer for reading from load cells

- 3-way isolation
- Supply for measuring bridges up to 4 x 350 Ω
- Simple calibration of the tare weight using external switch or PLC input
- Input and output ranges adjustable via DIP switch

ACT20P-BRIDGE-S

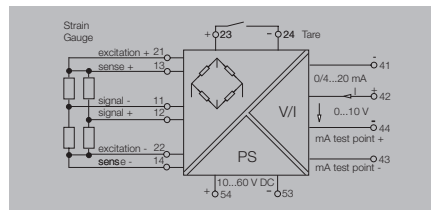

Technical data

Input	
Type	Resistance measuring bridge
Bridge sensitivity	1.0 mV / V to 5.0 mV / V
Input measurement range	± 10 mV / ± 20 mV / ± 30 mV / ± 50 mV (adjustable)
Input resistance	> 1 MΩ
Sensor supply	120 mA @ 10 V (= 4 x 350 Ω bridge resistors)
Bridge supply voltage	5 V or 10 V
Output	
Type	Voltage and current output (configurable)
Output voltage / Output current	0 ... 11 V (adjustable) / 0...22 mA (adjustable)
Load impedance, voltage/current	600 Ω / ≤ 600 Ω
General data	
Configuration	DIP switch
Supply voltage	10...60 V DC
Power consumption	3 W @ 24 V DC
Linearity	Typically ± 0.05 % of signal range
Repeat accuracy	± 0.05% of signal range
Humidity	10...90 % (no condensation)
Temperature coefficient	typ. 0.005 % / °C
Long-term drift	0.1 % / 10.000 h
Step response time	< 400 ms (10...90 %)
Ambient temperature	-40 °C...70 °C
Approvals	EAC; GOSTME25
Insulation coordination	
Standards	DIN EN 61010-1, DIN EN 61000-4-2
EMC standards	EN 61326
Rated voltage	300 V _{eff}
Impulse withstand voltage	4 kV (1.2/50 μs)
Pollution degree	2
Overvoltage category	III
Insulation voltage	5.7 kV (input / output, input / supply)

Dimensions

Clamping range (nominal / min. / max.)
Depth x width x height

Note

Screw connection

2.5 / 0.5 / 2.5
113.6 / 22.5 / 117.2

Ordering data

Type	Qty.	Order No.
ACT20P-BRIDGE-S	1	1067250000

Note

Accessories

Note

Front panel DIP Switch settings

Switch	Action if On	Action if Off
1	10 V Excitation	5 V Excitation
2	mA Output	Voltage Output
3	10 mV Span	Turn off for other ranges
4	20 mV Span	
5	30 mV Span	
6	50 mV Span	
7	4-wire Measurement	6-wire Measurement
8		

Connections

Terminal	Signal	
11	Signal -	Input signal
12	Signal +	
13	Sense +	Bridge Excitation Voltage
14	Sense -	
21	Excitation +	
22	Excitation -	
23	Tare +	External Tare switch
24	Tare -	
41	mA Output -	Output signal
42	Output +	
43	mA-Test Point -	
44	Voltage Output -	Power Supply
44	mA-Test Point +	
54	+	
53	-	

WAVESERIES – Signal converters

Isolation and conversion of analogue signals – enclosed in a rail-mounted WAVEBOX housing

WAVESERIES products are well suited for users seeking an analogue signal conversion solution. Weidmüller's WAVESERIES integrates a wide variety of functions into a compact, space-saving design. This product line covers a broad range of products suitable for many different analogue signal conditioning applications.

- Passive isolation amplifier for standard analogue signals
- Active isolation amplifier for standard analogue signals with 2-way or 3-way isolation
- Isolating signal converters for temperature (RTDs / thermocouples), resistance, potentiometer, frequency, AC/DC currents up to 60 A, and AC voltages up to 450 V.
- Measuring transducer for measuring AC currents up to 500 A
- Signal converters for all common input signals, with configuration (either DIP switch or with software)
- Signal converters with analogue and relay outputs, fully configurable via interface and software

Service

No tools are required when removing the PCB from the housing. Simply push in the locking clips on the head piece and then pull out the upper section along with the connections and the PCB.

Saves time

The ZQV 2.5N cross-connector can be used to connect the housing together in order to bridge the power supply between the modules.



Security

You must ensure the presence of "protective separation" in accordance with EN50178. The WAVESERIES products are able to fulfil these requirements completely.

Flexibility



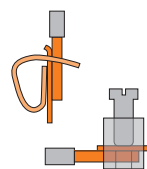



The BLZ/ BLZF pluggable screw and tension-clamp connections offer you the best flexibility. Coding elements can be used (without loss of poles) to make sure that the wrong plug cannot be inserted.







Protection

The WAVEBOX housing is made from recyclable plastics. It is available in widths of 12.5, 17.5, 22 or 45 mm. Practically no tools are required during installation. All requirements and EMC are met. The integrated ventilation slits ensure that sufficient heat dissipation takes place.



	Universal signal converter
	3-way isolator, configurable
	3-way isolator
	2 way isolator, Output Loop Powered
	Passive Isolators, Input and Output Loop Powered
	Temperature transmitters

	Frequency converters
	Current monitoring
	Voltage monitoring
	Bridge measurement isolator/ converter
	Serial interface isolation converter

WAVE TTA – one module fits all ...

In the case of signal processing this is a big benefit. The maintenance engineer who hasn't got the right spare isolator or transmitter, and has to run part of the plant on manual control for a day or two before the replacement arrives understands this. It wastes his time and money. So Weidmüller has designed a signal processor with unique flexibility.

In one module the Wave TTA is an intelligent signal

- Isolator
- Converter
- Transmitter
- Lineariser
- Trip-amplifier

The new WAVE TTA is a "universal" Transmitter Trip-Amplifier. It is part of Weidmüller's well-established WAVESERIES family of analogue signal conditioners, which are widely used in process and factory automation applications.

The TTA is unique. It has a combination of high performance and exceptional configurability. Designed for process industry applications, the TTA will work accurately and stably over a wide ambient temperature range, and over a wide supply voltage range, and with most types of sensor inputs. For 2-wire current transmitters 24 V DC power is provided. Alternatively the TTA can be a passive input for the current source.

Most commonly used temperature sensors and DC inputs are accepted, and the TTA also allows the user to define his own characteristics, so special sensor types and linearisation can easily be accommodated.

To help simplify installation and loop commissioning, test terminals are provided to permit input and output signal checks without removing cabling.

For linearised and/or isolated analogue outputs, the user has a choice of standard or variable DC milliamps and voltage ranges. These can be set as either direct or reverse acting. The user can also select upscale or downscale output in the event of a sensor break or an open circuit in the input.

The TTA provides 2 changeover-relay outputs which can be independently set, for use as high and low level alarms or control points.

Configuring the versatile TTA to change input and output parameters is simple, and performed from a computer via an interface (CBX200 USB).

Powering the TTA is flexible too. When the auxiliary supply is anything between 18 and 264 V (AC or DC), one module can take it.

Physically, the TTA comes in a black WAVESERIES housing with a flammability class V0 acc. UL 94, for mounting on TS 35 DIN rail. Pluggable connectors, allow screw or tension clamp wiring. A screwdriver-releasable front flap gives access to the configuration interface socket.

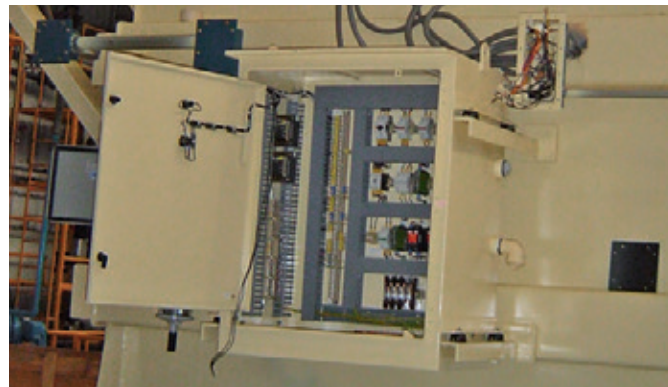

WAVESERIES – Universal signal converters and trip amplifiers, configurable



The free software TTA-Set allows fast and uncomplicated configuration of the WAVE TTA . Easily adjustable measurement window, transmit functions and switching thresholds, as well as different thresholds and alarms for faults.

Signal converters

D

Universal input signals

- Temperature signals (such as RTDs), One module integrates thermocouples and potentiometers, frequency transmitter, DC voltage signals and DC current signals.

Current source or loop powered input

- For DC current inputs the TTA can be used with either a passive input, or provide power for a two-wire transmitter.

Wide AC/DC power input (18-264 V AC/DC)

User-definable characterisation

- If none of the standard input linearisation options suit the sensor, a special curve can easily be created.

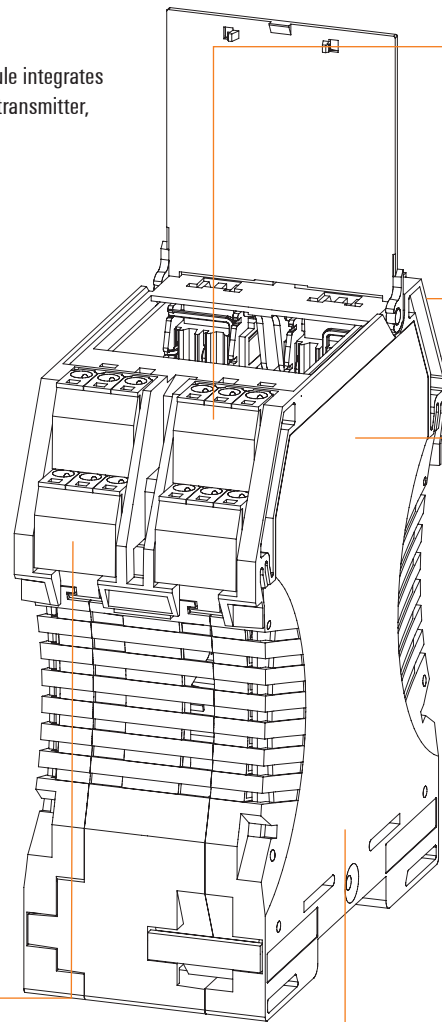

Inputs & outputs configurable via computer

- The range of configurability of the TTA is remarkable - and made easy using TTA SET software, in conjunction with the CBX200 USB interface.

Both analogue and relay outputs

- In one module the TTA integrates adjustable alarm or control outputs from mechanical relays, as well as it's proportional analogue output.

Wide ambient temperature range (-40 to 70 °C)

- Mounting the TTA outside in the field is no problem. It's ambient temperature range means it can also be field enclosure mounted.

High accuracy and temperature stability

- The Wave TTA offers superior performance and minimises losses for data acquisition systems, with its output accuracy typically < 0.1 %, and temperature stability < 0.01 %/K

Milliamp signal testing without removing cables

- The current and voltage inputs can be tested using a supplemental test contact without loosening the existing wiring.

UL Class I Div.2 and ATEX Zone 2 approvals

WAVESERIES - Universal signal converter and trip amplifier, configurable

WAVE TTA

- Input and outputs can be configured on PC with the TTA-SET software, download at www.weidmueller.com
- Universal input signals
- Loop-powered or passive input
- Pluggable connection terminals

WAS6 TTA / WAZ6 TTA

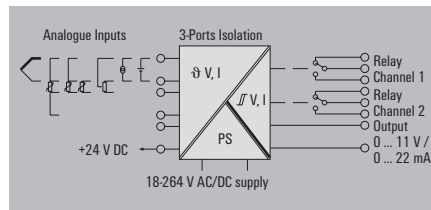

Technical data

Input	
Sensor	Thermocouples: B, E, J, K, L, N, R, S, T (IEC 60584), PT100, PT1000, (EN 60571) Ni100, Ni1000, (JIS1604), Cu10, Cu25, Cu50, Cu100 (DIN 43760) 2-/3-/4-wire
Potentiometer	100 Ω...100 kΩ
Resistance	10 Ω...5 kΩ
Input frequency	2 Hz...100 kHz
Input voltage	-200...500 mV (min. 4 mV span), -20...50 V DC (min. 0.5 V span)
Input current	-20...50 mA (min. span 0.4 mA)
Sensor supply	24 V DC / 22 mA
Output analogue	
Output voltage	Adjustable between -10...+10 V (min. span of 2.5 V)
Output current	Adjustable between 0...20 mA (min. span of 5 mA)
Load impedance, voltage/current	> 10 kΩ @ 0...10 V / > 20 kΩ @ -10...+10 V / < 700 Ω
Signal output	direct or inverted
Transmit function	Linear, $x^{1/2}$, $x^{3/2}$, $x^{3/2}$ or user-defined curve (101 points)
Output digital	
Type	2 x 1 CO contact (hard gold-plated)
Switching voltage AC, max. / DC, max.	250 V / 30 V
Continuous current	3 A AC / 2 A DC
General data	
Configuration	TTA Set Software
Supply voltage	18...264 V AC/DC
Power consumption	< 3.5 W
Accuracy	< 0.1 % span (DC, RTD); 0.2 % span (or 1 °C) + CJ failure
Temperature coefficient	< 0.1 % / K (DC, RTD); < 0.1 % FSR / K + CJ error 0.07 °C/K (thermocouples)
Ambient temperature / Storage temperature	/ -40 °C...70 °C / -40 °C...85 °C
Step response time	50 ms...1 sec (RTD, mV inputs), 110 ms...1 sec (V, mA inputs)
Humidity	5...95 %, no condensation
Approvals	CE; cULus; EAC; GL
Insulation coordination	
Standards	DIN EN 50178, DIN EN 61000-4-2
EMC standards	EN 55011, EN 61000-6
Rated voltage	300 V
Impulse withstand voltage	6 kV
Pollution degree	2
Overvoltage category	III
Clearance & creepage distances	≥ 5.5 mm (1 mm <small>input/output</small>)
Insulation voltage	2.5 kV

Dimensions	
Clamping range (nominal / min. / max.)	mm ²
Depth x width x height	mm

Note

Screw connection	Tension clamp connection
2.5/0.5/2.5	2.5/0.5/2.5
112.4/45	112.4/45

Typical functions

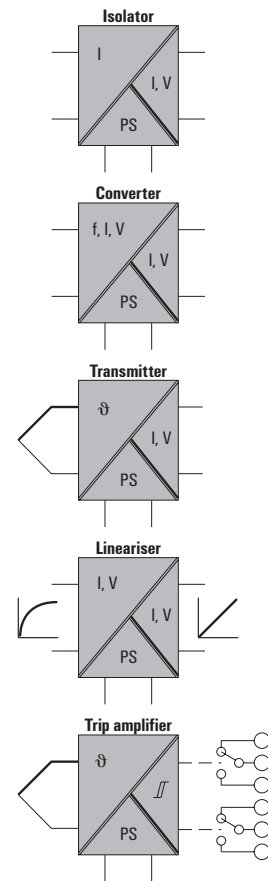

Ordering data

Type	Qty.	Order No.
Screw connection		
WAS6 TTA	1	8939670000
Tension clamp conn.		
WAZ6 TTA	1	8939680000

CBX200 USB configuration adapter - 8978580000

WAVESERIES - Universal signal converter and trip amplifier, configurable

WAVE TTA EX

- Input and outputs can be configured on PC with the TTA-SET software, download at www.weidmueller.com
- Universal input signals
- Loop-powered or passive input
- Pluggable connection terminals
- ATEX 3 G Ex nA IIC T4
- UL Class I, Div.2

WAS6 TTA EX / WAZ6 TTA EX

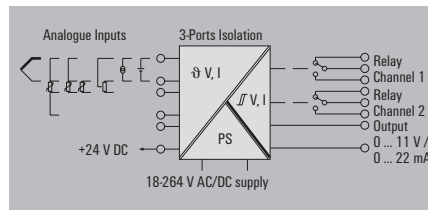

Technical data

Input

Sensor

Potentiometer

Resistance

Input frequency

Input voltage

Input current

Sensor supply

Thermocouples: B, E, J, K, L, N, R, S, T (IEC 60584), PT100, PT1000, (EN 60571) Ni100, Ni1000, (JIS1604), Cu10, Cu25, Cu50, Cu100 (DIN 43760) 2-/3-/4-wire

100 Ω...100 kΩ

10 Ω...5 kΩ

2 Hz...100 kHz

-200...500 mV (min. 4 mV span), -20...50 V DC (min. 0.5 V span)

-20...50 mA (min. span 0.4 mA)

24 V DC / 22 mA

Output analogue

Output voltage

Output current

Load impedance, voltage/current

Signal output

Transmit function

Adjustable between -10...+10 V (min. span of 2.5 V)

Adjustable between 0...20 mA (min. span of 5 mA)

> 10 kΩ @ 0...10 V / > 20 kΩ @ -10...+10 V / < 700 Ω

direct or inverted

Linear, $x^{1/2}$, $x^{2/2}$, $x^{3/2}$ or user-defined curve (101 points)

Output digital

Type

Switching voltage AC, max. / DC, max.

Continuous current

2 x 1 CO contact (hard gold-plated)

250 V / 30 V

2 A AC/DC

General data

Configuration

Supply voltage

Power consumption

Accuracy

Temperature coefficient

TTA Set Software

24...240 V AC/DC; 24...36 V AC / 24...50 V DC (ATEX Zone 2)

< 3.5 W

< 0.1 % span (DC, RTD); 0.2 % span (or 1 °C) + CJ failure

< 0.1 % / K (DC, RTD); < 0.1 % FSR / K + CJ error 0.07 °C/K (thermocouples)

Insulation coordination

Ambient temperature / Storage temperature

Step response time

Humidity

Approvals

-40 °C...70 °C / -40 °C...85 °C

50 ms...1 sec (RTD, mV inputs), 110 ms...1 sec (V, mA inputs)

5...95 %, no condensation

CE; cULus; cULusEX; EAC; KEMAATEX

Standards

EMC standards

Rated voltage

Impulse withstand voltage

Pollution degree

Overvoltage category

Clearance & creepage distances

Insulation voltage

DIN EN 50178, DIN EN 60079, DIN EN 61000-4-2

EN 55011, EN 61000-6

300 V

6 kV

2

III

≥ 5.5 mm (1 mm _{input/output})

2.5 kV

Dimensions

Clamping range (nominal / min. / max.) mm²

Depth x width x height mm

Screw connection

2.5/0.5/2.5

112.4/17.5

Tension clamp connection

1.5/0.5/2.5

112.4/17.5

Note

Typical functions

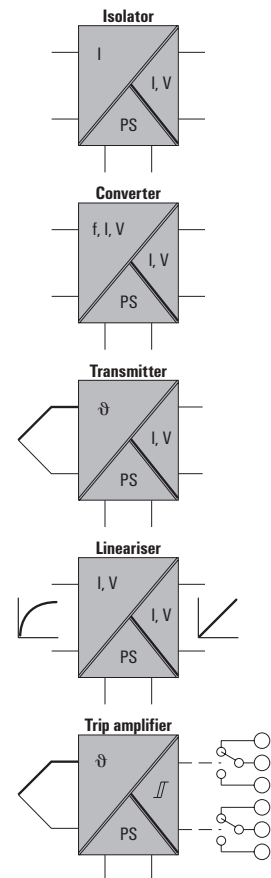

Ordering data

Type	Qty.	Order No.
Screw connection		
WAS6 TTA EX	1	8964310000
Tension clamp conn.		
WAZ6 TTA EX	1	8964320000

CBX200 USB configuration adapter - 8978580000

Signal converters

D

WAVESERIES - DC/DC 3-way isolator

20 kHz limiting frequency

- Signal conversion
- Galvanic isolation between input/output signals and power supply
- Power supply can be cross-connected using plug-in jumpers

0 (4)...20 mA/0 (4)...20 mA

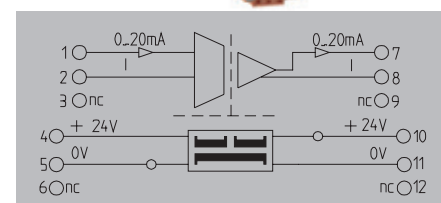

0...20 mA / 0...10 V

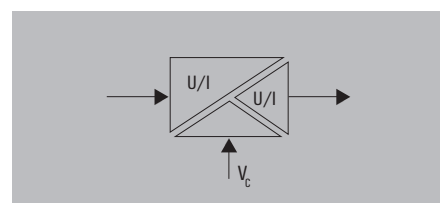
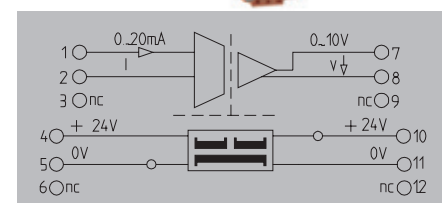

Technical data

Input	0 (4)...20 mA / 0 (4)...20 mA	0...20 mA / 0...10 V
Input voltage / Input current	/ 0...20 mA, 4...20mA	/ 0...20 mA
Input resistance, voltage/current	/ 50 Ω	/ 50 Ω
Output		
Output voltage / Output current	/ 0...20 mA, 4...20 mA	0...10 V /
Load impedance, voltage/current	/ ≤ 500 Ω	≥ 2 kΩ /
Cut-off frequency (-3 dB)	≥ 15 kHz (typ. 20 kHz)	≥ 15 kHz (typ. 20 kHz)
General data		
Configuration	none	none
Supply voltage	24 V DC ± 25 %	24 V DC ± 25 %
Power consumption	< 1.5 W @ I _{OUT} = 20 mA	< 1.3 W @ I _{OUT} = 5 mA
Accuracy	< 0.2 % of end value	< 0.2 % of end value
Temperature coefficient	≤ 250 ppm/K of final value	≤ 250 ppm/K of final value
Step response time	≤ 40 μs (typ. 30 μs)	≤ 40 μs (typ. 30 μs)
Ambient temperature	0 °C...55 °C	0 °C...55 °C
Approvals	CE, CSA, cULus, EAC	CE, CSA, cULus, EAC
Insulation coordination		
Standards	DIN EN 50178, DIN EN 61000-4-2	DIN EN 50178, DIN EN 61000-4-2
EMC standards	EN 55011, EN 61000-6	EN 55011, EN 61000-6
Rated voltage	300 V	300 V
Impulse withstand voltage	4 kV	4 kV
Insulation voltage	1.2 kV _{eff} / 5 s	1.2 kV _{eff} / 5 s
Overvoltage category	III	III
Pollution degree	2	2
Clearance & creepage distances	≥ 3 mm	≥ 3 mm

Dimensions	Screw connection	Tension clamp connection	Screw connection
Clamping range (nominal / min. / max.)	2.5/0.5/2.5	1.5/0.5/2.5	2.5/0.5/2.5
Depth x width x height	112.4/17.5	112.4/17.5	112.4/17.5
Note			

Ordering data

	Type	Qty.	Order No.
Screw connection	WAS5 CCC HF 0-20/0-20MA	1	8447160000
Tension-clamp connection	WAZ5 CCC HF 0-20/0-20MA	1	8447170000
	WAS5 CVC HF 0-20/0-10V	1	8447220000

Note		

Accessories

Note		
	Cross-connector for power supplies and markers – refer to Accessories	Cross-connector for power supplies and markers – refer to Accessories

WAVESERIES - DC/DC 3-way isolator

20 kHz limiting frequency

- Signal conversion
- Galvanic isolation between input/output signals and power supply
- Power supply can be cross-connected using plug-in jumpers

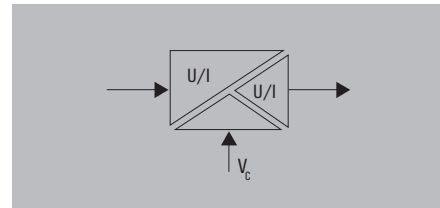

4...20 mA / 0...20 mA

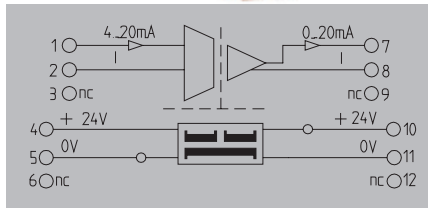

4...20 mA / 0...10 V



UL Class I, Div. 2

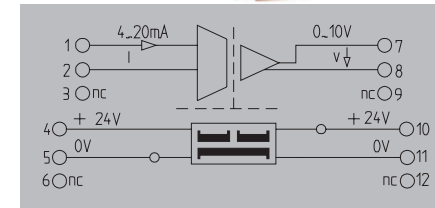

Technical data

Input	4...20 mA / 0...20 mA	4...20 mA / 0...10 V
Input voltage / Input current	/ 4...20 mA	/ 4...20 mA
Input resistance, voltage/current	/ 50 Ω	/ 50 Ω
Output		
Output voltage / Output current	/ 0...20 mA	0...10 V /
Load impedance, voltage/current	/ ≤ 500 Ω	≥ 2 kΩ / ≤ 600 Ω
Cut-off frequency (-3 dB)	≥ 15 kHz (typ. 20 kHz)	≥ 15 kHz (typ. 20 kHz)
General data		
Configuration	none	none
Supply voltage	24 V DC ± 25 %	24 V DC ± 25 %
Power consumption	< 1.5 W @ I _{OUT} = 20 mA	< 1.3 W @ I _{OUT} = 5 mA
Accuracy	< 0.2 % of end value	< 0.2 % of end value
Temperature coefficient	≤ 250 ppm/K of final value	≤ 250 ppm/K of final value
Step response time	≤ 40 μs (typ. 30 μs)	≤ 40 μs (typ. 30 μs)
Ambient temperature	0 °C...55 °C	0 °C...55 °C
Approvals	CE, CSA, cULus, EAC	CE, CSA, cULus, cULusEX, EAC
Insulation coordination		
Standards	DIN EN 50178, DIN EN 61000-4-2	DIN EN 50178, DIN EN 61000-4-2
EMC standards	EN 55011, EN 61000-6	EN 55011, EN 61000-6
Rated voltage	300 V	300 V
Impulse withstand voltage	4 kV	4 kV
Insulation voltage	1.2 kV _{eff} / 5 s	1.2 kV _{eff} / 5 s
Overvoltage category	III	III
Pollution degree	2	2
Clearance & creepage distances	≥ 3 mm	≥ 3 mm

Dimensions	Screw connection	Screw connection
Clamping range (nominal / min. / max.)	mm ² 2.5/0.5/2.5	2.5/0.5/2.5
Depth x width x height	mm 112.4/17.5	112.4/17.5
Note		

Ordering data

	Type	Qty.	Order No.
Screw connection	WAS5 CCC HF 4-20/0-20MA	1	8447250000
Tension-clamp connection	WAS5 CVC HF 4-20/0-10V	1	8447280000

Note		
------	--	--

Accessories

Note	Cross-connector for power supplies and markers – refer to Accessories	Cross-connector for power supplies and markers – refer to Accessories
------	---	---

Signal converters

D

WAVESERIES - DC/DC 3-way isolator

20 kHz limiting frequency

- Signal conversion
- Galvanic isolation between input/output signals and power supply
- Power supply can be cross-connected using plug-in jumpers

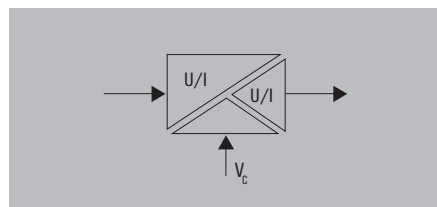

0...10 V / 0...20 mA

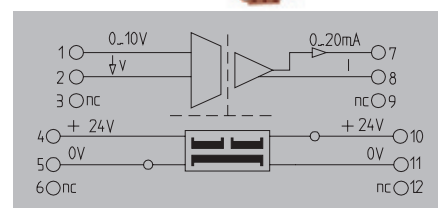

0...10 V / 4...20 mA



UL Class I, Div. 2

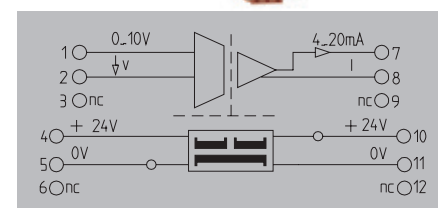

Technical data

Input	0...10 V /	0...10 V /
Input voltage / Input current	500 k Ω /	500 k Ω /
Input resistance, voltage/current		
Output		
Output voltage / Output current	/ 0...20 mA	/ 4...20 mA
Load impedance, voltage/current	/ \leq 500 Ω	/ \leq 500 Ω
Cut-off frequency (-3 dB)	\geq 15 kHz (typ. 20 kHz)	\geq 15 kHz (typ. 20 kHz)
General data		
Configuration	none	none
Supply voltage	24 V DC \pm 25 %	24 V DC \pm 25 %
Power consumption	$<$ 1.5 W @ $I_{out} = 20$ mA	$<$ 1.5 W @ $I_{out} = 20$ mA
Accuracy	\pm 0.2 % of final value	\pm 0.2 % of final value
Temperature coefficient	\leq 250 ppm/K of final value	\leq 250 ppm/K of final value
Step response time	\leq 40 μ s (typ. 30 μ s)	\leq 40 μ s (typ. 30 μ s)
Ambient temperature	0 °C...55 °C	0 °C...55 °C
Approvals	CE, CSA, cULus, EAC	CE, CSA, cULus, cULusEX, EAC
Insulation coordination		
Standards	DIN EN 50178, DIN EN 61000-4-2	DIN EN 50178, DIN EN 61000-4-2
EMC standards	EN 55011, EN 61000-6	EN 55011, EN 61000-6
Rated voltage	300 V	300 V
Impulse withstand voltage	4 kV	4 kV
Insulation voltage	1.2 kV _{eff} / 5 s	1.2 kV _{eff} / 5 s
Overvoltage category	III	III
Pollution degree	2	2
Clearance & creepage distances	\geq 3 mm	\geq 3 mm

Dimensions

Clamping range (nominal / min. / max.)	mm ²
Depth x width x height	mm

Note

Screw connection

2.5/0.5/2.5
112.4/17.5

Note

Ordering data

Screw connection
Tension-clamp connection

Type	Qty.	Order No.
WAS5 VCC HF 0-10/0-20MA	1	8447310000

Note

Accessories

Note

Cross-connector for power supplies and markers – refer to Accessories

Screw connection

2.5/0.5/2.5
112.4/17.5

Note

Type	Qty.	Order No.
WAS5 VCC HF 0-10/4-20MA	1	8447340000

Note

Cross-connector for power supplies and markers – refer to Accessories

WAVESERIES - DC/DC 3-way isolator

20 kHz limiting frequency

- Signal conversion
- Galvanic isolation between input/output signals and power supply
- Power supply can be cross-connected using plug-in jumpers

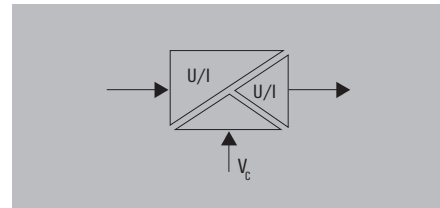

0...10 V / 0...10 V

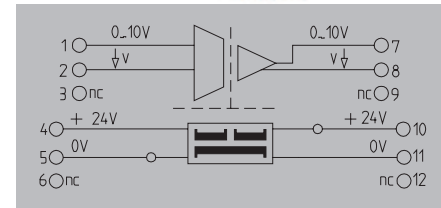

-10 V...+10 V / -10 V...+10 V

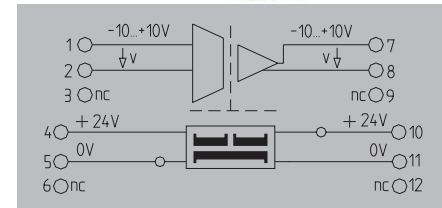

Signal converters

D

Technical data

Input	
Input voltage / Input current	0...10 V /
Input resistance, voltage/current	500 kΩ /
Output	
Output voltage / Output current	0...10 V /
Load impedance, voltage/current	≥ 2 kΩ /
Cut-off frequency (-3 dB)	≥ 15 kHz (typ. 20 kHz)
General data	
Configuration	none
Supply voltage	24 V DC ± 25 %
Power consumption	< 1.3 W @ I _{load} = 5 mA
Accuracy	± 0.2 % of final value
Temperature coefficient	≤ 250 ppm/K of final value
Step response time	≤ 40 μs (typ. 30 μs)
Ambient temperature	0 °C...55 °C
Approvals	CE, CSA, cULus, EAC
Insulation coordination	
Standards	DIN EN 50178, DIN EN 61000-4-2
EMC standards	EN 55011, EN 61000-6
Rated voltage	300 V
Impulse withstand voltage	4 kV
Insulation voltage	1.2 kV _{eff} / 5 s
Overvoltage category	III
Pollution degree	2
Clearance & creepage distances	≥ 3 mm

Input	
Input voltage / Input current	0...10 V /
Input resistance, voltage/current	500 kΩ /
Output	
Output voltage / Output current	0...10 V /
Load impedance, voltage/current	≥ 2 kΩ /
Cut-off frequency (-3 dB)	≥ 15 kHz (typ. 20 kHz)
General data	
Configuration	none
Supply voltage	24 V DC ± 25 %
Power consumption	< 1.3 W @ I _{load} = 5 mA
Accuracy	± 0.2 % of final value
Temperature coefficient	≤ 250 ppm/K of final value
Step response time	≤ 40 μs (typ. 30 μs)
Ambient temperature	0 °C...55 °C
Approvals	CE, CSA, cULus, EAC
Insulation coordination	
Standards	DIN EN 50178, DIN EN 61000-4-2
EMC standards	EN 55011, EN 61000-6
Rated voltage	300 V
Impulse withstand voltage	4 kV
Insulation voltage	1.2 kV _{eff} / 5 s
Overvoltage category	III
Pollution degree	2
Clearance & creepage distances	≥ 3 mm

Input	
Input voltage / Input current	-10...+10 V /
Input resistance, voltage/current	500 kΩ /
Output	
Output voltage / Output current	-10...+10 V /
Load impedance, voltage/current	≥ 2 kΩ /
Cut-off frequency (-3 dB)	≥ 15 kHz (typ. 20 kHz)
General data	
Configuration	none
Supply voltage	24 V DC ± 25 %
Power consumption	< 1.3 W @ I _{load} = 5 mA
Accuracy	± 0.2 % of measuring range
Temperature coefficient	≤ 250 ppm/K of measuring range
Step response time	≤ 40 μs (typ. 30 μs)
Ambient temperature	0 °C...55 °C
Approvals	CE, cULus, EAC
Insulation coordination	
Standards	DIN EN 50178, DIN EN 61000-4-2
EMC standards	EN 55011, EN 61000-6
Rated voltage	300 V
Impulse withstand voltage	4 kV
Insulation voltage	1.2 kV _{eff} / 5 s
Overvoltage category	III
Pollution degree	2
Clearance & creepage distances	≥ 3 mm

Dimensions	
Clamping range (nominal / min. / max.)	mm ²
Depth x width x height	mm
Note	

Screw connection		Tension clamp connection	
Clamping range (nominal / min. / max.)	mm ²	Clamping range (nominal / min. / max.)	mm ²
Depth x width x height	mm	Depth x width x height	mm
Note		Note	

Screw connection	
Clamping range (nominal / min. / max.)	mm ²
Depth x width x height	mm
Note	

Ordering data

Screw connection	
Clamping range (nominal / min. / max.)	mm ²
Depth x width x height	mm
Note	

Type	Qty.	Order No.
WAS5 VVC HF 0-10/0-10V	1	8447370000
WAZ5 VVC HF 0-10/0-10V	1	8447380000

Type	Qty.	Order No.
WAS5 VVC HF +10V/+10V	1	8561610000

Accessories

Note	
------	--

Note	
------	--

Note	
------	--

WAVESERIES - DC/DC 3-way isolator

10 Hz limiting frequency

- Signal conversion
- Galvanic isolation between input/output signals and power supply
- Power supply can be cross-connected using plug-in jumpers

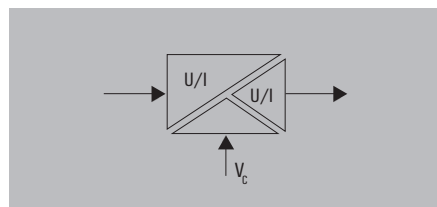

0(4)...20 mA / 0(4)...20 mA

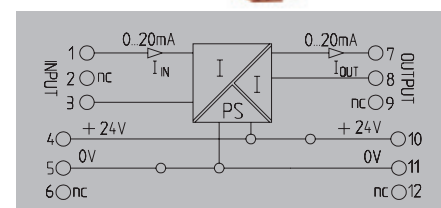

0...20 mA / 4...20 mA

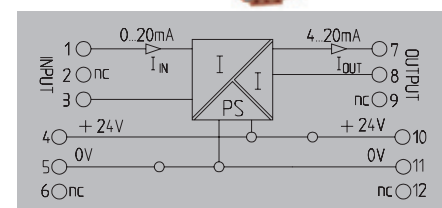

Technical data

Input	0(4)...20 mA / 0(4)...20 mA	0...20 mA / 4...20 mA
Input voltage / Input current	/ 0...20 mA, 4...20mA	/ 0...20 mA
Output		
Output voltage / Output current	/ 0...20 mA, 4...20 mA	/ 4...20 mA
Load impedance, voltage/current	/ $\leq 600 \Omega$	/ $\leq 600 \Omega$
Cut-off frequency (-3 dB)	10 Hz	10 Hz
General data		
Configuration	none	none
Supply voltage	24 V DC $\pm 25 \%$	24 V DC $\pm 25 \%$
Power consumption	$< 1.5 \text{ W} @ I_{\text{OUT}} = 20 \text{ mA}$	$< 1.5 \text{ W} @ I_{\text{OUT}} = 20 \text{ mA}$
Accuracy	0.2 %	0.2 %
Temperature coefficient	$\pm 250 \text{ ppm/K}$	$\pm 250 \text{ ppm/K}$
Step response time	$\leq 45 \text{ ms}$	$\leq 45 \text{ ms}$
Ambient temperature	0 °C...55 °C	0 °C...55 °C
Approvals	CE; cULus; EAC	CE; cULus; EAC
Insulation coordination		
Standards	DIN EN 50178, DIN EN 61000-4-2	DIN EN 50178, DIN EN 61000-4-2
EMC standards	EN 55011, EN 61000-6	EN 55011, EN 61000-6
Rated voltage	300 V	300 V
Impulse withstand voltage	4 kV	4 kV
Insulation voltage	2 kV _{eff} / 5 s	2 kV _{eff} / 5 s
Overvoltage category	III	III
Pollution degree	2	2
Clearance & creepage distances	$\geq 3 \text{ mm}$	$\geq 3 \text{ mm}$

Dimensions	Screw connection	Tension clamp connection	Screw connection
Clamping range (nominal / min. / max.)	2.5/0.5/2.5	1.5/0.5/2.5	2.5/0.5/2.5
Depth x width x height	112.4/17.5	112.4/17.5	112.4/17.5
Note			

Ordering data

	Type	Qty.	Order No.	Type	Qty.	Order No.
Screw connection	WAS5 CCC 0-20/0-20mA	1	8540180000	WAS5 CCC 0-20/4-20mA	1	8540250000
Tension-clamp connection	WAZ5 CCC 0-20/0-20mA	1	8540190000			

Note		

Accessories

Note		
	Cross-connectors for power supplies and markers: refer to accessories	Cross-connectors for power supplies and markers: refer to accessories

WAVESERIES - DC/DC 3-way isolator

Signal converters

D

10 Hz limiting frequency

- Signal conversion
- Galvanic isolation between input/output signals and power supply
- Power supply can be cross-connected using plug-in jumpers

0...20 mA / 0...10 V

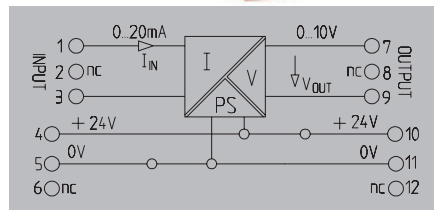
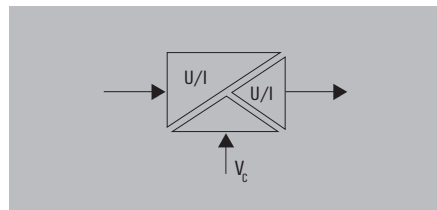

Technical data

Input	
Input voltage / Input current	/ 0...20 mA
Output	
Output voltage / Output current	0...10 V /
Load impedance, voltage/current	≥ 1 kΩ /
Cut-off frequency (-3 dB)	10 Hz
General data	
Configuration	none
Supply voltage	24 V DC ± 25 %
Power consumption	< 1.3 W @ I _{OUT} = 5 mA
Accuracy	0.2 %
Temperature coefficient	± 250 ppm/K
Step response time	≤ 45 ms
Ambient temperature	0 °C...55 °C
Approvals	CE; cULus; EAC
Insulation coordination	
Standards	DIN EN 50178, DIN EN 61000-4-2
EMC standards	EN 55011, EN 61000-6
Rated voltage	300 V
Impulse withstand voltage	4 kV
Insulation voltage	2 kV _{eff} / 5 s
Overvoltage category	III
Pollution degree	2
Clearance & creepage distances	≥ 3 mm

	/ 0...20 mA
	0...10 V /
	≥ 1 kΩ /
	10 Hz
	none
	24 V DC ± 25 %
	< 1.3 W @ I _{OUT} = 5 mA
	0.2 %
	± 250 ppm/K
	≤ 45 ms
	0 °C...55 °C
	CE; cULus; EAC
	DIN EN 50178, DIN EN 61000-4-2
	EN 55011, EN 61000-6
	300 V
	4 kV
	2 kV _{eff} / 5 s
	III
	2
	≥ 3 mm

Dimensions

Clamping range (nominal / min. / max.)	mm ²
Depth x width x height	mm
Note	

Screw connection

2.5/0.5/2.5
112.4/17.5

Ordering data

Screw connection
Tension-clamp connection
Note

Type	Qty.	Order No.
WAS5 CVC 0-20mA/0-10V	1	8540270000

Accessories

Note

Cross-connectors for power supplies and markers: refer to accessories

WAVESERIES - DC/DC 3-way isolator

10 Hz limiting frequency

- Signal conversion
- Galvanic isolation between input/output signals and power supply
- Power supply can be cross-connected using plug-in jumpers

4...20 mA / 0...20 mA



4...20 mA / 0...10 V

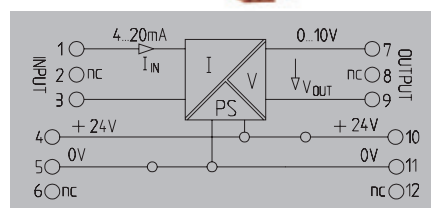
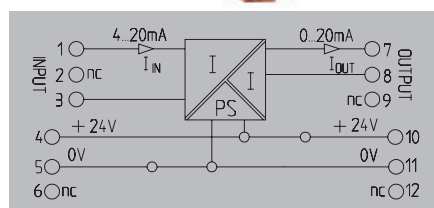
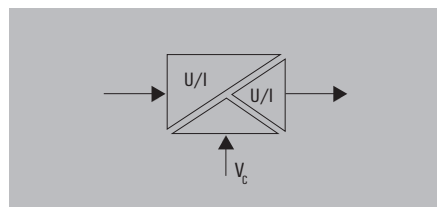

Technical data

Input	4...20 mA	4...20 mA
Input voltage / Input current	/ 4...20 mA	/ 4...20 mA
Output		
Output voltage / Output current	/ 0...20 mA	0...10 V /
Load impedance, voltage/current	/ $\leq 600 \Omega$	$\geq 1 \text{ k}\Omega$ /
Cut-off frequency (-3 dB)	10 Hz	10 Hz
General data		
Configuration	none	none
Supply voltage	24 V DC $\pm 25 \%$	24 V DC $\pm 25 \%$
Power consumption	$< 1.5 \text{ W}$ @ $I_{\text{OUT}} = 20 \text{ mA}$	$< 1.3 \text{ W}$ @ $I_{\text{OUT}} = 5 \text{ mA}$
Current-carrying capacity of cross-connect.	$\leq 2 \text{ A}$	$\leq 2 \text{ A}$
Accuracy	0.2 %	0.2 %
Temperature coefficient	$\pm 250 \text{ ppm/K}$	$\pm 250 \text{ ppm/K}$
Step response time	$\leq 45 \text{ ms}$	$\leq 45 \text{ ms}$
Ambient temperature	0 °C...55 °C	0 °C...55 °C
Approvals	CE; cULus; EAC	CE; cULus; EAC
Insulation coordination		
Standards	DIN EN 50178, DIN EN 61000-4-2	DIN EN 50178, DIN EN 61000-4-2
EMC standards	EN 55011, EN 61000-6	EN 55011, EN 61000-6
Rated voltage	300 V	300 V
Impulse withstand voltage	4 kV	4 kV
Insulation voltage	2 kV _{eff} / 5 s	2 kV _{eff} / 5 s
Overvoltage category	III	III
Pollution degree	2	2
Clearance & creepage distances	$\geq 3 \text{ mm}$	$\geq 3 \text{ mm}$

Dimensions
Clamping range (nominal / min. / max.)
Depth x width x height
Note

Screw connection
Clamping range (nominal / min. / max.)
Depth x width x height

Screw connection
Clamping range (nominal / min. / max.)
Depth x width x height

Ordering data

Type	Qty.	Order No.	Type	Qty.	Order No.
WAS5 CCC 4-20/0-20mA	1	8540200000	WAS5 CVC 4-20mA/0-10V	1	8540230000

Note

Note

Note

Accessories

Note
Cross-connectors for power supplies and markers: refer to accessories

Note
Cross-connectors for power supplies and markers: refer to accessories

Note
Cross-connectors for power supplies and markers: refer to accessories

WAVESERIES - DC/DC 3-way isolator

10 Hz limiting frequency

- Signal conversion
- Galvanic isolation between input/output signals and power supply
- Power supply can be cross-connected using plug-in jumpers

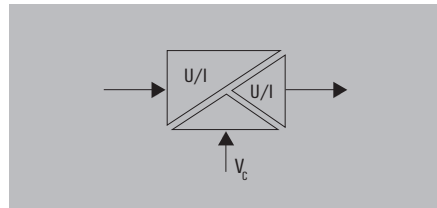

0...10 V / 0...20 mA

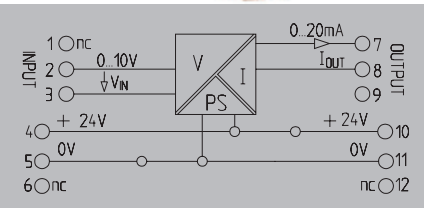

0...10 V / 4...20 mA

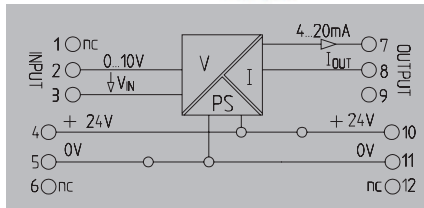

Technical data

Input	
Input voltage / Input current	0...10 V /
Output	
Output voltage / Output current	/ 0...20 mA
Load impedance, voltage/current	/ ≤ 600 Ω
Cut-off frequency (-3 dB)	10 Hz
General data	
Configuration	none
Supply voltage	24 V DC ± 25 %
Power consumption	< 1.5 W @ I _{OUT} = 20 mA
Accuracy	0.2 %
Temperature coefficient	± 250 ppm/K
Step response time	≤ 45 ms
Ambient temperature	0 °C...55 °C
Approvals	CE; cULus; EAC
Insulation coordination	
Standards	DIN EN 50178, DIN EN 61000-4-2
EMC standards	EN 55011, EN 61000-6
Rated voltage	300 V
Impulse withstand voltage	4 kV
Insulation voltage	2 kV _{eff} / 5 s
Overvoltage category	III
Pollution degree	2
Clearance & creepage distances	≥ 3 mm

	0...10 V /
	/ 0...20 mA
	/ ≤ 600 Ω
	10 Hz
	none
	24 V DC ± 25 %
	< 1.5 W @ I _{OUT} = 20 mA
	0.2 %
	± 250 ppm/K
	≤ 45 ms
	0 °C...55 °C
	CE; cULus; EAC
	DIN EN 50178, DIN EN 61000-4-2
	EN 55011, EN 61000-6
	300 V
	4 kV
	2 kV _{eff} / 5 s
	III
	2
	≥ 3 mm

	0...10 V /
	/ 4...20 mA
	/ ≤ 600 Ω
	10 Hz
	none
	24 V DC ± 25 %
	< 1.5 W @ I _{OUT} = 20 mA
	0.2 %
	± 250 ppm/K
	≤ 45 ms
	0 °C...55 °C
	CE; cULus; EAC
	DIN EN 50178, DIN EN 61000-4-2
	EN 55011, EN 61000-6
	300 V
	4 kV
	2 kV _{eff} / 5 s
	III
	2
	≥ 3 mm

Dimensions	
Clamping range (nominal / min. / max.)	mm ²
Depth x width x height	mm
Note	

Screw connection	Tension clamp connection
2.5/0.5/2.5	1.5/0.5/2.5
112.4/17.5	112.4/17.5

Screw connection	Tension clamp connection
2.5/0.5/2.5	1.5/0.5/2.5
112.4/17.5	112.4/17.5

Ordering data

Screw connection	
Tension-clamp connection	
Note	

Type	Qty.	Order No.
WAS5 VCC 0-10V/0-20mA	1	8540310000
WAZ5 VCC 0-10V/0-20mA	1	8540320000

Type	Qty.	Order No.
WAS5 VCC 0-10V/4-20mA	1	8540290000
WAZ5 VCC 0-10V/4-20mA	1	8540300000

Accessories

Note	
-------------	--

Cross-connectors for power supplies and markers: refer to accessories

Cross-connectors for power supplies and markers: refer to accessories

Signal converters

D

WAVESERIES - DC/DC 3-way isolator

10 Hz limiting frequency

- Signal conversion
- Galvanic isolation between input/output signals and power supply
- Power supply can be cross-connected using plug-in jumpers

0...10 V / 0...10 V

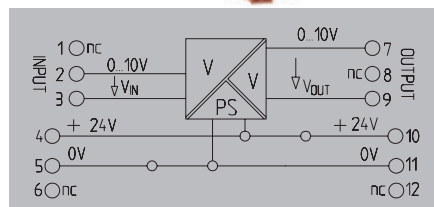
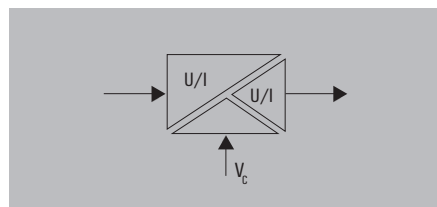

Technical data

Input	
Input voltage / Input current	0...10 V /
Output	
Output voltage / Output current	0...10 V /
Load impedance, voltage/current	$\geq 1 \text{ k}\Omega$ /
Cut-off frequency (-3 dB)	10 Hz
General data	
Configuration	none
Supply voltage	24 V DC $\pm 25\%$
Power consumption	$< 1.3 \text{ W}$ @ $I_{OUT} = 5 \text{ mA}$
Current-carrying capacity of cross-connect.	$\leq 2 \text{ A}$
Accuracy	0.2 %
Temperature coefficient	$\pm 250 \text{ ppm/K}$
Step response time	$\leq 45 \text{ ms}$
Ambient temperature	0 °C...55 °C
Approvals	CE; cULus; EAC
Insulation coordination	
Standards	DIN EN 50178, DIN EN 61000-4-2
EMC standards	EN 55011, EN 61000-6
Rated voltage	300 V
Impulse withstand voltage	4 kV
Insulation voltage input or output/supply	2 kV _{eff} / 5 s
Overvoltage category	III
Pollution degree	2
Clearance & creepage distances	$\geq 3 \text{ mm}$

Dimensions		Screw connection	Tension clamp connection
Clamping range (nominal / min. / max.)	mm ²	2.5/0.5/2.5	1.5/0.5/2.5
Depth x width x height	mm	112.4/17.5	112.4/17.5
Note			

Ordering data

Type	Qty.	Order No.
WAS5 VVC 0-10V/0-10V	1	8540330000
WAZ5 VVC 0-10V/0-10V	1	8540340000

Note	
-------------	--

Accessories

Note	Cross-connectors for power supplies and markers: refer to accessories
-------------	---

Signal converters

D

WAVESERIES - DC/DC 2-way isolator

Output-side supply

- Signal conversion
- Galvanic isolation between input and output signals
- Power supply can be cross-connected using plug-in jumpers

4...20 mA / 4...20 mA

UL Class I, Div. 2



4...20 mA / 0...20 mA

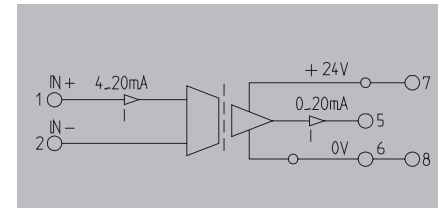
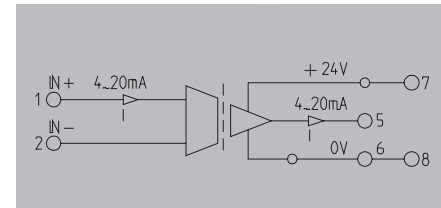
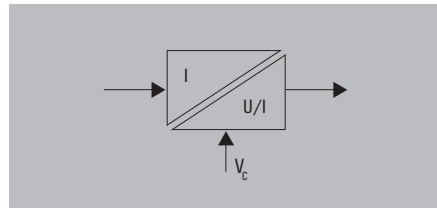

Technical data

Input	4...20 mA / 4...20 mA	4...20 mA / 0...20 mA
Input voltage / Input current	/ 4...20 mA	/ 4...20 mA
Output		
Output voltage / Output current	/ 4...20 mA	/ 0...20 mA
Load impedance, voltage/current	/ ≤ 500 Ω	/ ≤ 500 Ω
Cut-off frequency (-3 dB)	≥ 15 Hz (typ. 20 Hz)	≥ 15 Hz (typ. 20 Hz)
General data		
Configuration	none	none
Supply voltage	24 V DC ± 20 %	24 V DC ± 20 %
Current consumption	< 32 mA @ I _{OUT} = 20 mA	< 32 mA @ I _{OUT} = 20 mA
Current-carrying capacity of cross-connect.	≤ 2 A	≤ 2 A
Accuracy	± 0.2 % of final value	± 0.2 % of final value
Temperature coefficient	≤ 250 ppm/K of final value	≤ 250 ppm/K of final value
Step response time	≤ 30 ms (typ. 20 ms)	≤ 30 ms (typ. 20 ms)
Ambient temperature	0 °C...55 °C	0 °C...55 °C
Approvals	CE; CSA; cULus; cULusEX; EAC	CE; CSA; cULus; EAC
Insulation coordination		
Standards	DIN EN 50178, DIN EN 61000-4-2	DIN EN 50178, DIN EN 61000-4-2
EMC standards	EN 55011, EN 61000-6	EN 55011, EN 61000-6
Rated voltage	300 V	300 V
Impulse withstand voltage	4 kV	4 kV
Insulation voltage	1.2 kV _{eff} / 5 s	1.2 kV _{eff} / 5 s
Overvoltage category	III	III
Pollution degree	2	2
Clearance & creepage distances	≥ 3 mm	≥ 3 mm

Dimensions	Screw connection	Tension clamp connection	Screw connection
Clamping range (nominal / min. / max.)	2.5/0.5/2.5	1.5/0.5/2.5	2.5/0.5/2.5
Depth x width x height	112.4/12.5	112.4/12.5	112.4/12.5
Note			

Ordering data

	Type	Qty.	Order No.	Type	Qty.	Order No.
Screw connection	WAS4 CCC DC 4-20/4-20MA	1	8444980000	WAS4 CCC DC 4-20/0-20MA	1	8445010000
Tension-clamp connection	WAZ4 CCC DC 4-20/4-20MA	1	8444990000			

Note		

Accessories

Note		
	Cross-connector for power supplies and markers – refer to Accessories	Cross-connector for power supplies and markers – refer to Accessories

WAVESERIES - DC/DC 2-way isolator

Signal converters

D

Output-side supply

- Signal conversion
- Galvanic isolation between input and output signals
- Power supply can be cross-connected using plug-in jumpers

4...20 mA / 0...10 V

UL Class I, Div. 2

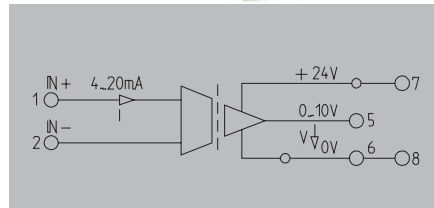
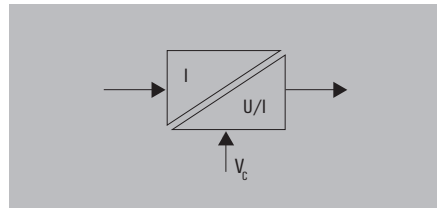

Technical data

Input	
Input voltage / Input current	/ 4...20 mA
Output	
Output voltage / Output current	0...10 V /
Load impedance, voltage/current	≥ 1 kΩ /
Cut-off frequency (-3 dB)	≥ 15 Hz (typ. 20 Hz)
General data	
Configuration	none
Supply voltage	24 V DC ± 20 %
Current consumption	< 20 mA @ I _{typ} = 10 mA
Current-carrying capacity of cross-connect.	≤ 2 A
Accuracy	± 0.2 % of final value
Temperature coefficient	≤ 250 ppm/K of final value
Step response time	≤ 30 ms (typ. 20 ms)
Ambient temperature	0 °C...55 °C
Approvals	CE; CSA; cULus; cULusEX; EAC
Insulation coordination	
Standards	DIN EN 50178, DIN EN 61000-4-2
EMC standards	EN 55011, EN 61000-6
Rated voltage	300 V
Impulse withstand voltage	4 kV
Insulation voltage	1.2 kV _{eff} / 5 s
Overvoltage category	III
Pollution degree	2
Clearance & creepage distances	≥ 3 mm

Dimensions		Screw connection	Tension clamp connection
Clamping range (nominal / min. / max.)	mm ²	2.5/0.5/2.5	1.5/0.5/2.5
Depth x width x height	mm	112.4/12.5	112.4/12.5
Note			

Ordering data

	Type	Qty.	Order No.
Screw connection	WAS4 CVC DC 4-20/0-10V	1	8445040000
Tension-clamp connection	WAZ4 CVC DC 4-20/0-10V	1	8445050000

Note	
-------------	--

Accessories

Note	Cross-connector for power supplies and markers – refer to Accessories
-------------	---

WAVESERIES - DC/DC passive isolator

Signal distributor

Supplied by current loop

- Galvanic isolation
- Input and output current loop feed
- Very low power consumption
- No calibration necessary

20LP

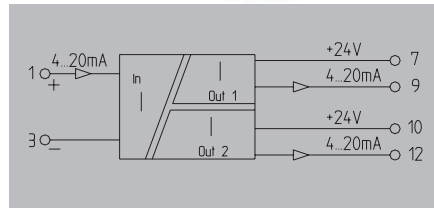
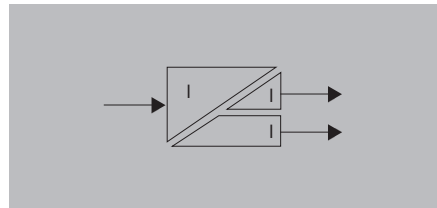

Technical data

Input	
Input current	4...20 mA (current loop)
Voltage drop	3.8 V
Output	
Output current	2 x 4...20 mA (current loop)
Output signal limit	Approx. 31 mA
Load impedance, voltage/current	$/ R_L = (U_{0-12V}) / 20 \text{ mA z.B. } 600 \Omega \text{ at } 24 \text{ V}$
Cut-off frequency (-3 dB)	30 Hz
General data	
Configuration	none
Supply voltage	min. 12 V DC/ max. 30 V DC
Accuracy	typ. 0.1 %; max. 0.2 %
Temperature coefficient	$\leq 150 \text{ ppm/K}$
Step response time	$< 20 \text{ ms}$
Ambient temperature	0 °C...55 °C
Approvals	CE; cULus; EAC
Insulation coordination	
Standards	DIN EN 50178, DIN EN 61000-4-2
EMC standards	EN 55011, EN 61000-6
Rated voltage	300 V
Impulse withstand voltage	4 kV
Insulation voltage input or output/supply	4 kV _{eff} / 5 s
Overvoltage category	III
Pollution degree	2
Clearance & creepage distances	$\geq 5.5 \text{ mm}$

Example of application

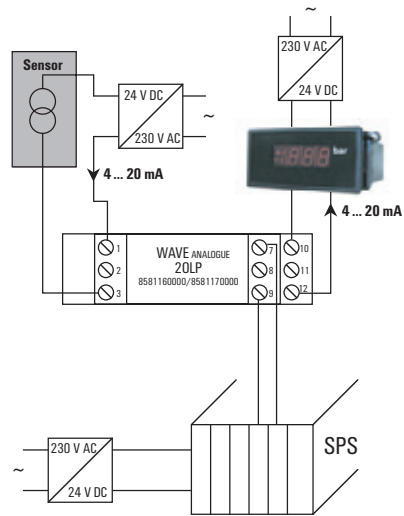

Dimensions

Clamping range (nominal / min. / max.)	mm ²
Depth x width x height	mm

Note

Screw connection Tension clamp connection

2.5/0.5/2.5	1.5/0.5/2.5
112.4/17.5	112.4/17.5

Ordering data

	Type	Qty.	Order No.
Screw connection	WAS5 CCC 20LP	1	8581160000
Tension-clamp connection	WAZ5 CCC 20LP	1	8581170000

Note

Accessories

Note

Markers - refer to Accessories.

WAVESERIES - DC/DC passive isolator

Signal converters

D

Signal distributor

Supplied by current loop

- Galvanic isolation
- Input and output current loop feed
- Very low power consumption
- No calibration necessary
- ATEX II 3 G Ex nA IIC T4
- UL Class I, Div. 2

20LP

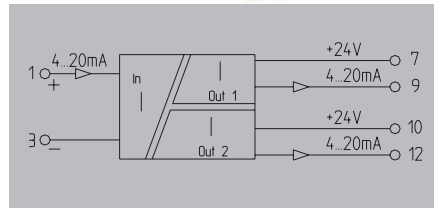
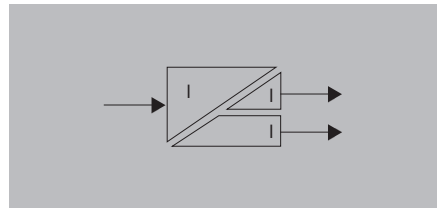

Technical data

Input	
Input current	4...20 mA (current loop)
Voltage drop	3.8 V
Output	
Output current	2 x 4...20 mA (current loop)
Output signal limit	Approx. 31 mA
Load impedance, voltage/current	$R_L = (U_{s2} - 12 V) / 20 \text{ mA}$ z.B. 600 Ω at 24 V
Cut-off frequency (-3 dB)	30 Hz
General data	
Configuration	none
Supply voltage	min. 12 V DC/ max. 30 V DC
Accuracy	typ. 0.1 %; max. 0.2 %
Temperature coefficient	≤ 150 ppm/K
Step response time	< 20 ms
Ambient temperature	0 °C...55 °C
Approvals	CE; cULusEX; DEMKOATEX; EAC
Insulation coordination	
Standards	DIN EN 60079, DIN EN 61000-4-2
EMC standards	EN 55011, EN 61000-6
Rated voltage	300 V
Impulse withstand voltage	4 kV
Insulation voltage input or output/supply	4 kV _{eff} / 5 s
Overvoltage category	III
Pollution degree	2
Clearance & creepage distances	≥ 5.5 mm

Input	
Input current	4...20 mA (current loop)
Voltage drop	3.8 V
Output	
Output current	2 x 4...20 mA (current loop)
Output signal limit	Approx. 31 mA
Load impedance, voltage/current	$R_L = (U_{s2} - 12 V) / 20 \text{ mA}$ z.B. 600 Ω at 24 V
Cut-off frequency (-3 dB)	30 Hz
General data	
Configuration	none
Supply voltage	min. 12 V DC/ max. 30 V DC
Accuracy	typ. 0.1 %; max. 0.2 %
Temperature coefficient	≤ 150 ppm/K
Step response time	< 20 ms
Ambient temperature	0 °C...55 °C
Approvals	CE; cULusEX; DEMKOATEX; EAC
Insulation coordination	
Standards	DIN EN 60079, DIN EN 61000-4-2
EMC standards	EN 55011, EN 61000-6
Rated voltage	300 V
Impulse withstand voltage	4 kV
Insulation voltage input or output/supply	4 kV _{eff} / 5 s
Overvoltage category	III
Pollution degree	2
Clearance & creepage distances	≥ 5.5 mm

Example of application

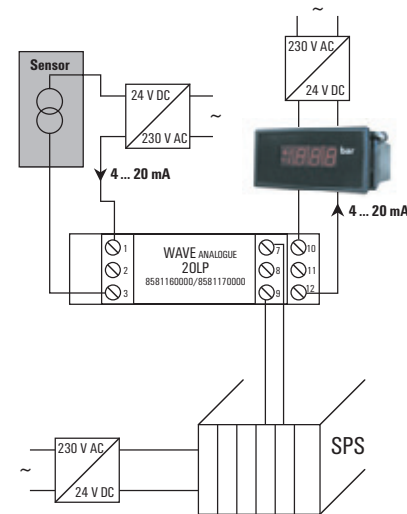

Dimensions	
Clamping range (nominal / min. / max.)	mm²
Depth x width x height	mm
Note	

Screw connection	
Clamping range (nominal / min. / max.)	mm²
Depth x width x height	mm
Note	

Ordering data

Screw connection	
Tension-clamp connection	
Note	

Type	Qty.	Order No.
WAS5 CCC 20LP EX	1	8975640000
Note		

Accessories

Note	
------	--

Markers - refer to Accessories.

WAVESERIES - DC/DC passive isolator

Output-current loop-powered

- Galvanic isolation
- Very low power consumption
- Input range selected via DIP switch
- No calibration necessary

OLP

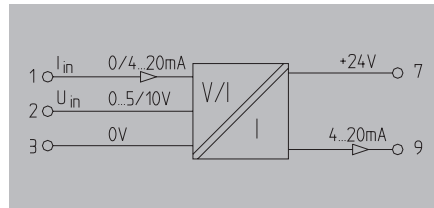
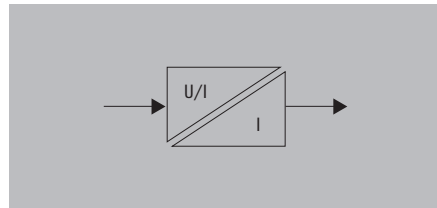

Technical data

Input

Input voltage
 Input resistance, voltage/current
 Input current
 Rated current

0...5 V; 210 kΩ; 0...10 V; 430 kΩ / 51 Ω
 0...20 mA, 4...20mA
 40 mA

Output

Output current
 Output signal limit
 Load impedance, voltage/current
 Cut-off frequency (-3 dB)

4...20 mA (current loop)
 Approx. 31 mA
 $R_L = (U_o - 12 V) / 20 \text{ mA z.B. } 600 \Omega \text{ at } 24 \text{ V}$
 10 Hz/ 100 Hz switchable

General data

Configuration
 Supply voltage

DIP switch
 min. 12 V DC/ max. 30 V DC, Loop powered, via 4...20 mA input

Ambient temperature
 Default setting
 Accuracy
 Temperature coefficient
 Step response time
 Approvals

0 °C...55 °C
 0...20mA, 10 Hz
 0.2% of measuring range final value
 $\leq 150 \text{ ppm/K}$
 $< 10 \text{ Hz: } 80 \text{ ms; } 100 \text{ Hz: } 50 \text{ ms}$
 CE; cULus; EAC

Insulation coordination

Standards
 EMC standards
 Rated voltage
 Impulse withstand voltage
 Insulation voltage
 Overvoltage category
 Pollution degree
 Clearance & creepage distances

DIN EN 50178, DIN EN 61000-4-2
 EN 55011, EN 61000-6
 300 V
 4 kV
 $4 \text{ kV}_{eff} / 5 \text{ s}$
 III
 2
 $\geq 5.5 \text{ mm}$

Dimensions

Clamping range (nominal / min. / max.) mm²
 Depth x width x height mm

Screw connection Tension clamp connection

2.5/0.5/2.5 1.5/0.5/2.5
 112.4/17.5 112.4/17.5

Note

Ordering data

Screw connection
 Tension-clamp connection

Type	Qty.	Order No.
WAS5 OLP	1	8543720000
WAZ5 OLP	1	8543730000

Note

Accessories

Note

Markers - refer to Accessories.

Setting options/switch position

Input	SW 1			
	1	2	3	4
0 ... 20 mA	<input type="checkbox"/>	<input type="checkbox"/>	<input type="checkbox"/>	<input type="checkbox"/>
4 ... 20 mA	<input checked="" type="checkbox"/>	<input type="checkbox"/>	<input type="checkbox"/>	<input type="checkbox"/>
0 ... 5 V	<input checked="" type="checkbox"/>	<input checked="" type="checkbox"/>	<input checked="" type="checkbox"/>	<input type="checkbox"/>
0 ... 10 V	<input type="checkbox"/>	<input checked="" type="checkbox"/>	<input type="checkbox"/>	<input type="checkbox"/>
Transmission frequency				
10 Hz	<input type="checkbox"/>	<input type="checkbox"/>	<input type="checkbox"/>	<input checked="" type="checkbox"/>
100 Hz	<input type="checkbox"/>	<input type="checkbox"/>	<input type="checkbox"/>	<input type="checkbox"/>

■ = on
 = off

Example of application

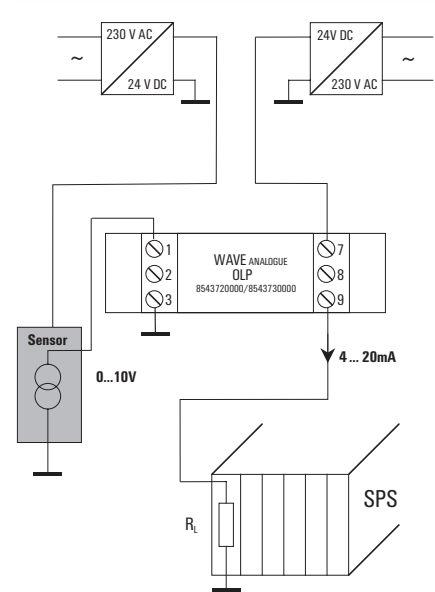

WAVESERIES - DC/DC passive isolator

Signal converters

D

Input current loop feed

- Safe separation
- Very low power consumption
- UL Class I, Div. 2

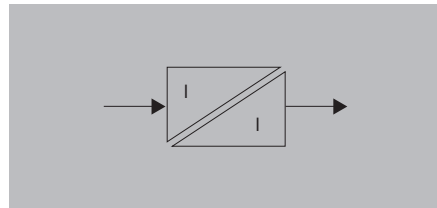

CCC LP

(1-channel)

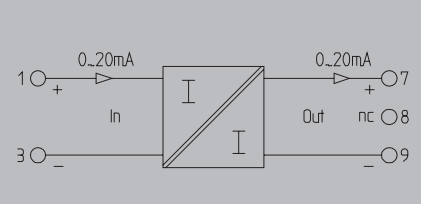

CCC LP

(2-channel)

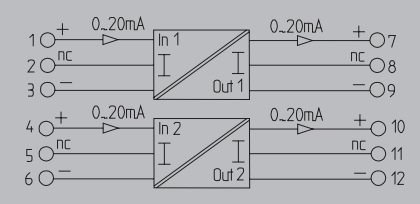

Technical data

Input	
Input voltage / Input current	/ 0..20 mA current loop
Pick-up current	< 100 µA
Voltage drop	Approx. 3 V at R _L = 0 Ω; approx. 13 V at R _L = 500 Ω; (I _{in} = 20 mA)
Output	
Output voltage / Output current	/ 0..20 mA, 4..20 mA
Load impedance, voltage/current	/ ≤ 500 Ω
General data	
Configuration	none
Ambient temperature	-25 °C...70 °C
Accuracy	< 0.1 % of end value
Temperature coefficient	≤ 50 ppm/K of final value
Approvals	CE, CSA; cULus; cULusEX; EAC; GL
Insulation coordination	
Standards	DIN EN 50178, DIN EN 61000-4-2
EMC standards	EN 55011, EN 61000-6
Rated voltage	300 V
Impulse withstand voltage	6 kV
Insulation voltage	4 kV _{eff} / 1 s
Overvoltage category	III
Pollution degree	2
Clearance & creepage distances	≥ 5.5 mm

Input	
Input voltage / Input current	/ 0..20 mA current loop
Pick-up current	< 100 µA
Voltage drop	Approx. 3 V at R _L = 0 Ω; approx. 13 V at R _L = 500 Ω; (I _{in} = 20 mA)
Output	
Output voltage / Output current	/ 0..20 mA, 4..20 mA
Load impedance, voltage/current	/ ≤ 500 Ω
General data	
Configuration	none
Ambient temperature	-25 °C...70 °C
Accuracy	< 0.1 % of end value
Temperature coefficient	≤ 50 ppm/K of final value
Approvals	CE, CSA; cULus; cULusEX; EAC; GL
Insulation coordination	
Standards	DIN EN 50178, DIN EN 61000-4-2
EMC standards	EN 55011, EN 61000-6
Rated voltage	300 V
Impulse withstand voltage	6 kV
Insulation voltage	4 kV _{eff} / 1 s
Overvoltage category	III
Pollution degree	2
Clearance & creepage distances	≥ 5.5 mm

Input	
Input voltage / Input current	/ 0..20 mA current loop
Pick-up current	< 100 µA
Voltage drop	Approx. 3 V at R _L = 0 Ω; approx. 13 V at R _L = 500 Ω; (I _{in} = 20 mA)
Output	
Output voltage / Output current	/ 0..20 mA, 4..20 mA
Load impedance, voltage/current	/ ≤ 500 Ω
General data	
Configuration	none
Ambient temperature	-25 °C...70 °C
Accuracy	< 0.1 % of end value
Temperature coefficient	≤ 50 ppm/K of final value
Approvals	CE, CSA; cULus; cULusEX; EAC; GL
Insulation coordination	
Standards	DIN EN 50178, DIN EN 61000-4-2
EMC standards	EN 55011, EN 61000-6
Rated voltage	300 V
Impulse withstand voltage	6 kV
Insulation voltage	4 kV _{eff} / 1 s
Overvoltage category	III
Pollution degree	2
Clearance & creepage distances	≥ 5.5 mm

Dimensions	
Clamping range (nominal / min. / max.)	mm ²
Depth x width x height	mm
Note	

Screw connection		Tension clamp connection	
Clamping range (nominal / min. / max.)	mm ²	Clamping range (nominal / min. / max.)	mm ²
Depth x width x height	mm	Depth x width x height	mm
Note		Note	

Screw connection		Tension clamp connection	
Clamping range (nominal / min. / max.)	mm ²	Clamping range (nominal / min. / max.)	mm ²
Depth x width x height	mm	Depth x width x height	mm
Note		Note	

Ordering data

Screw connection	
Tension-clamp connection	
Note	

Type	Qty.	Order No.
WAS5 CCC LP 0-20/0-20mA	1	8444950000
WAZ5 CCC LP 0-20/0-20mA	1	8444960000
Note		

Type	Qty.	Order No.
WAS5 CCC LP 0-20/0-20mA	1	8463580000
WAZ5 CCC LP 0-20/0-20mA	1	8463590000
Note		

Accessories

Note	
------	--

Markers - refer to Accessories.

Markers - refer to Accessories.

WAVESERIES - Temperature measuring transducer

RTD signal isolator/converter

- Universally adjustable via DIP switch
- 3-way isolation
- Linearisation
- Power supply can be cross-connected using plug-in jumpers
- WAVETOOL software helps with configuration, download at www.weidmueller.com

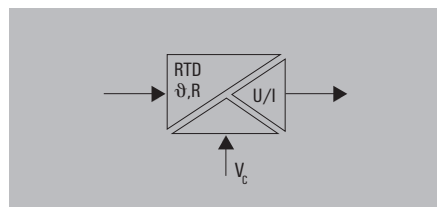

PRO RTD

UL Class I, Div. 2

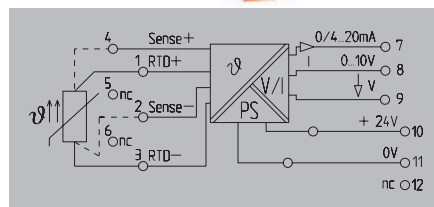

Technical data

Input	
Sensor	PT100/2-/3-/4-wire, Ni100/2-/3-/4-wire, potentiometer: min. 100 Ω , max. 100 k Ω , resistance: 0-450 Ω
Temperature input range	Configurable, PT100: -200°C...850°C, NI100: -60°C...+250°C
Output	
Output current / Output voltage	0...20 mA, 4...20 mA / 0...10 V
Offset current / Offset voltage	max. 100 μ A / max. 0.05 V
Load impedance, voltage/current	≥ 1 k Ω / ≤ 600 Ω
Sensor error detection	LED flashing (output value: > 20 mA, >10 V)
Fine adjustment	$\geq \pm 5$ %, Version 1 and later: ≥ 12.5 % / potentiometer: 12.5%...25%
Status indicator	Module active: LED on/ wire breakage: LED flashing/ Error: LED off
General data	
Configuration	DIP switch, Potentiometer
Supply voltage	
Power consumption	830...880...980mW at $I_{out} = 20$ mA
Step response time	fast/slow: 2-/3-/4-conductor: 1.2 s/2.2 s; potentiometer: 0.5 s/1.1 s
Ambient temperature	0 °C...55 °C
Approvals	CE; cULus; cULusEX; EAC; GL
Insulation coordination	
Standards	DIN EN 50178, DIN EN 61000-4-2
EMC standards	EN 55011, EN 61000-6
Rated voltage	300 V
Impulse withstand voltage	4 kV
Insulation voltage	2 kV _{eff} / 5 s
Overvoltage category	III
Pollution degree	2
Clearance & creepage distances	≥ 3 mm

Dimensions		Screw connection	Tension clamp connection
Clamping range (nominal / min. / max.)	mm ²	2.5/0.5/2.5	1.5/0.5/2.5
Depth x width x height	mm	112.4/17.5	112.4/17.5
Note			

Ordering data

Type	Qty.	Order No.
WAS5 PRO RTD	1	8560700000
WAZ5 PRO RTD	1	8560710000

Note	

Accessories

Note	Cross-connector for power supplies and markers – refer to Accessories

PRO RTD

Switch position / setting options

Choice of inputs			Switch 1		
Input			1	2	3
PT100	2-wire	<input checked="" type="checkbox"/>	<input checked="" type="checkbox"/>	<input checked="" type="checkbox"/>	<input checked="" type="checkbox"/>
PT100	3-wire	<input type="checkbox"/>	<input checked="" type="checkbox"/>	<input checked="" type="checkbox"/>	<input checked="" type="checkbox"/>
PT100	4-wire	<input checked="" type="checkbox"/>	<input type="checkbox"/>	<input checked="" type="checkbox"/>	<input checked="" type="checkbox"/>
R	2-wire	<input type="checkbox"/>	<input type="checkbox"/>	<input type="checkbox"/>	<input checked="" type="checkbox"/>
NI100	2-wire	<input checked="" type="checkbox"/>	<input checked="" type="checkbox"/>	<input type="checkbox"/>	<input type="checkbox"/>
NI100	3-wire	<input type="checkbox"/>	<input checked="" type="checkbox"/>	<input type="checkbox"/>	<input type="checkbox"/>
NI100	4-wire	<input checked="" type="checkbox"/>	<input type="checkbox"/>	<input type="checkbox"/>	<input type="checkbox"/>
Potentiometer		<input type="checkbox"/>	<input type="checkbox"/>	<input type="checkbox"/>	<input type="checkbox"/>

= on
 = off

Choice of outputs			Switch 2	
Output			6	7
0...10 V		<input checked="" type="checkbox"/>	<input type="checkbox"/>	<input type="checkbox"/>
0...5 V		<input checked="" type="checkbox"/>	<input checked="" type="checkbox"/>	<input type="checkbox"/>
0...20 mA		<input type="checkbox"/>	<input type="checkbox"/>	<input type="checkbox"/>
4...20 mA		<input type="checkbox"/>	<input checked="" type="checkbox"/>	<input type="checkbox"/>

Switch on the manual fine adjustments		S. 1
Man. adjustment		8
off	<input type="checkbox"/>	<input type="checkbox"/>
on	<input checked="" type="checkbox"/>	<input checked="" type="checkbox"/>

Choice of step response time		S. 2
Step response time		8
slow	<input checked="" type="checkbox"/>	<input checked="" type="checkbox"/>
fast	<input type="checkbox"/>	<input type="checkbox"/>

Accuracy, slow/fast step response time						
PT 100, Ni 100: 0.3 % from measuring range 0.8 %						
from measuring range < 100 K / 0.3 K / 0.8 K						
Potentiometer: 0.2 % from end value / 0.3 %						
Resistance: 0.2 % from end value / 0.3 %						

Temperature coefficient			
Measuring range ≥ 200 K	≤ 200 ppm / °C		
100 K ≤ Measuring range < 200 K	≤ 250 ppm / °C		
40 K ≤ Measuring range < 100 K	≤ 400 ppm / °C		

Choice of minimum input size						
S _{min}	R _{min}	Poti _{min}	Switch 1			
0 °C	0 Ω	0 %	4	5	6	7
-10 °C	10 Ω	10 %	<input checked="" type="checkbox"/>	<input checked="" type="checkbox"/>	<input checked="" type="checkbox"/>	<input type="checkbox"/>
-20 °C	20 Ω	20 %	<input checked="" type="checkbox"/>	<input checked="" type="checkbox"/>	<input type="checkbox"/>	<input type="checkbox"/>
-25 °C	20 Ω	25 %	<input checked="" type="checkbox"/>	<input checked="" type="checkbox"/>	<input type="checkbox"/>	<input type="checkbox"/>
-30 °C	30 Ω	30 %	<input checked="" type="checkbox"/>	<input type="checkbox"/>	<input checked="" type="checkbox"/>	<input checked="" type="checkbox"/>
-40 °C	40 Ω	40 %	<input checked="" type="checkbox"/>	<input type="checkbox"/>	<input checked="" type="checkbox"/>	<input type="checkbox"/>
-50 °C	50 Ω	50 %	<input checked="" type="checkbox"/>	<input type="checkbox"/>	<input type="checkbox"/>	<input checked="" type="checkbox"/>
-60 °C	60 Ω	60 %	<input checked="" type="checkbox"/>	<input type="checkbox"/>	<input type="checkbox"/>	<input type="checkbox"/>
-70 °C	70 Ω	70 %	<input type="checkbox"/>	<input checked="" type="checkbox"/>	<input checked="" type="checkbox"/>	<input type="checkbox"/>
-80 °C	80 Ω	80 %	<input type="checkbox"/>	<input checked="" type="checkbox"/>	<input checked="" type="checkbox"/>	<input type="checkbox"/>
-90 °C	90 Ω		<input type="checkbox"/>	<input checked="" type="checkbox"/>	<input type="checkbox"/>	<input checked="" type="checkbox"/>
-100 °C	100 Ω		<input type="checkbox"/>	<input checked="" type="checkbox"/>	<input type="checkbox"/>	<input type="checkbox"/>
-150 °C	150 Ω		<input type="checkbox"/>	<input type="checkbox"/>	<input checked="" type="checkbox"/>	<input checked="" type="checkbox"/>
-200 °C	200 Ω		<input type="checkbox"/>	<input type="checkbox"/>	<input checked="" type="checkbox"/>	<input type="checkbox"/>
Special area			<input type="checkbox"/>	<input type="checkbox"/>	<input type="checkbox"/>	<input checked="" type="checkbox"/>

Adjustment example for zero and span					
Temperature adjustment:					
Output	4...20 mA				
DIP switch	-10 °C...+110 °C				
Span	75...110 °C				
Range	120 °C				
Adjustment range	± 12.5 %				

Choice of measuring range							
T	R	Poti	Switch 2				
			1	2	3	4	5
40 K	20 Ω	20 %	<input checked="" type="checkbox"/>	<input checked="" type="checkbox"/>	<input checked="" type="checkbox"/>	<input checked="" type="checkbox"/>	<input checked="" type="checkbox"/>
50 K	25 Ω	25 %	<input checked="" type="checkbox"/>	<input checked="" type="checkbox"/>	<input checked="" type="checkbox"/>	<input checked="" type="checkbox"/>	<input type="checkbox"/>
60 K	30 Ω	30 %	<input checked="" type="checkbox"/>	<input checked="" type="checkbox"/>	<input checked="" type="checkbox"/>	<input type="checkbox"/>	<input checked="" type="checkbox"/>
70 K	35 Ω	35 %	<input checked="" type="checkbox"/>	<input checked="" type="checkbox"/>	<input checked="" type="checkbox"/>	<input type="checkbox"/>	<input type="checkbox"/>
80 K	40 Ω	40 %	<input checked="" type="checkbox"/>	<input checked="" type="checkbox"/>	<input type="checkbox"/>	<input checked="" type="checkbox"/>	<input checked="" type="checkbox"/>
90 K	45 Ω	45 %	<input checked="" type="checkbox"/>	<input checked="" type="checkbox"/>	<input type="checkbox"/>	<input checked="" type="checkbox"/>	<input type="checkbox"/>
100 K	50 Ω	50 %	<input checked="" type="checkbox"/>	<input checked="" type="checkbox"/>	<input type="checkbox"/>	<input type="checkbox"/>	<input checked="" type="checkbox"/>
110 K	55 Ω	55 %	<input checked="" type="checkbox"/>	<input checked="" type="checkbox"/>	<input type="checkbox"/>	<input type="checkbox"/>	<input type="checkbox"/>
120 K	60 Ω	60 %	<input checked="" type="checkbox"/>	<input type="checkbox"/>	<input checked="" type="checkbox"/>	<input checked="" type="checkbox"/>	<input checked="" type="checkbox"/>
125 K	62.5 Ω	62.5 %	<input checked="" type="checkbox"/>	<input type="checkbox"/>	<input checked="" type="checkbox"/>	<input type="checkbox"/>	<input type="checkbox"/>
130 K	65 Ω	65 %	<input checked="" type="checkbox"/>	<input type="checkbox"/>	<input checked="" type="checkbox"/>	<input type="checkbox"/>	<input checked="" type="checkbox"/>
140 K	70 Ω	70 %	<input checked="" type="checkbox"/>	<input type="checkbox"/>	<input checked="" type="checkbox"/>	<input type="checkbox"/>	<input type="checkbox"/>
150 K	75 Ω	75 %	<input checked="" type="checkbox"/>	<input type="checkbox"/>	<input type="checkbox"/>	<input checked="" type="checkbox"/>	<input checked="" type="checkbox"/>
160 K	80 Ω	80 %	<input checked="" type="checkbox"/>	<input type="checkbox"/>	<input type="checkbox"/>	<input type="checkbox"/>	<input checked="" type="checkbox"/>
170 K	85 Ω	85 %	<input checked="" type="checkbox"/>	<input type="checkbox"/>	<input type="checkbox"/>	<input type="checkbox"/>	<input checked="" type="checkbox"/>
180 K	90 Ω	90 %	<input checked="" type="checkbox"/>	<input type="checkbox"/>	<input type="checkbox"/>	<input type="checkbox"/>	<input type="checkbox"/>
190 K	95 Ω	95 %	<input type="checkbox"/>	<input checked="" type="checkbox"/>	<input checked="" type="checkbox"/>	<input checked="" type="checkbox"/>	<input checked="" type="checkbox"/>
200 K	100 Ω	100 %	<input type="checkbox"/>	<input checked="" type="checkbox"/>	<input checked="" type="checkbox"/>	<input checked="" type="checkbox"/>	<input type="checkbox"/>
250 K	125 Ω	-	<input type="checkbox"/>	<input checked="" type="checkbox"/>	<input checked="" type="checkbox"/>	<input checked="" type="checkbox"/>	<input checked="" type="checkbox"/>
300 K	150 Ω	-	<input type="checkbox"/>	<input checked="" type="checkbox"/>	<input checked="" type="checkbox"/>	<input type="checkbox"/>	<input type="checkbox"/>
350 K	175 Ω	-	<input type="checkbox"/>	<input checked="" type="checkbox"/>	<input type="checkbox"/>	<input checked="" type="checkbox"/>	<input checked="" type="checkbox"/>
400 K	200 Ω	-	<input type="checkbox"/>	<input checked="" type="checkbox"/>	<input checked="" type="checkbox"/>	<input checked="" type="checkbox"/>	<input type="checkbox"/>
450 K	225 Ω	-	<input type="checkbox"/>	<input type="checkbox"/>	<input checked="" type="checkbox"/>	<input type="checkbox"/>	<input checked="" type="checkbox"/>
500 K	250 Ω	-	<input type="checkbox"/>	<input type="checkbox"/>	<input checked="" type="checkbox"/>	<input type="checkbox"/>	<input type="checkbox"/>
550 K	275 Ω	-	<input type="checkbox"/>	<input type="checkbox"/>	<input type="checkbox"/>	<input checked="" type="checkbox"/>	<input checked="" type="checkbox"/>
600 K	300 Ω	-	<input type="checkbox"/>	<input type="checkbox"/>	<input checked="" type="checkbox"/>	<input checked="" type="checkbox"/>	<input type="checkbox"/>
650 K	325 Ω	-	<input type="checkbox"/>	<input type="checkbox"/>	<input checked="" type="checkbox"/>	<input checked="" type="checkbox"/>	<input checked="" type="checkbox"/>
700 K	350 Ω	-	<input type="checkbox"/>	<input type="checkbox"/>	<input type="checkbox"/>	<input checked="" type="checkbox"/>	<input type="checkbox"/>
750 K	375 Ω	-	<input type="checkbox"/>	<input type="checkbox"/>	<input type="checkbox"/>	<input checked="" type="checkbox"/>	<input checked="" type="checkbox"/>
800 K	400 Ω	-	<input type="checkbox"/>	<input type="checkbox"/>	<input type="checkbox"/>	<input checked="" type="checkbox"/>	<input type="checkbox"/>
850 K	425 Ω	-	<input type="checkbox"/>	<input type="checkbox"/>	<input type="checkbox"/>	<input type="checkbox"/>	<input checked="" type="checkbox"/>
900 K	450 Ω	-	<input type="checkbox"/>	<input type="checkbox"/>	<input type="checkbox"/>	<input type="checkbox"/>	<input checked="" type="checkbox"/>

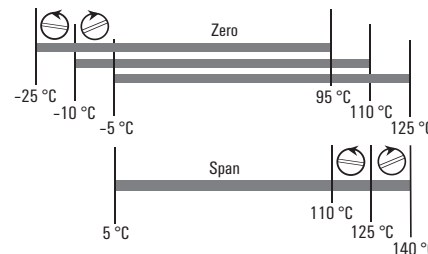

Wavetool adjustment tool
This service tool enables quick and straightforward configuration of the WAVE_{ANALOG} PRO.
Internet download:
<http://www.weidmueller.com>

WAVESERIES - Temperature measuring transducer

RTD signal isolator/converter

- Universally adjustable via DIP switch
- 3-way isolation
- Linearisation
- Power supply can be cross-connected using plug-in jumpers

PRO RTD 1000

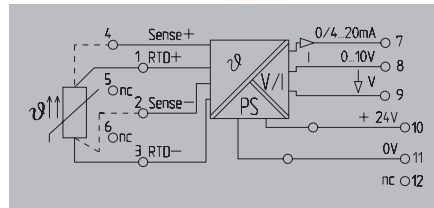
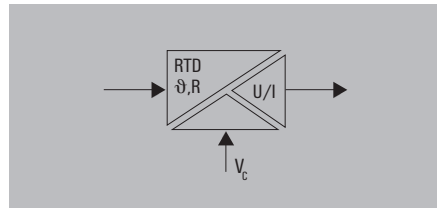

Technical data

Input

Sensor
Temperature input range

Output

Output current / Output voltage
Offset current / Offset voltage
Load impedance, voltage/current
Sensor error detection
Fine adjustment
Status indicator

General data

Configuration
Supply voltage
Power consumption
Step response time
Ambient temperature
Approvals

Insulation coordination

Standards
EMC standards
Rated voltage
Impulse withstand voltage
Insulation voltage
Overvoltage category
Pollution degree
Clearance & creepage distances

Ni1000/2-/3-/4-wire, Potentiometer: min. 0-1kΩ, max. 0-100kΩ,
PT1000/2-/3-/4-wire, Resistance: 0-4.5kΩ
Configurable, PT1000: -200°C...850°C, NI1000: -60°C...+250°C

0...20 mA, 4...20 mA / 0...10 V
max. 100 μA / max. 0.05 V
≥ 1 kΩ / ≤ 600 Ω
LED flashing (output value: > 20 mA, > 10 V)
± 12.5 % of FSR; potentiometer: ± 12.5 % ... ± 25 %
Module active: LED on/ wire breakage: LED flashing/
Error: LED off

DIP switch, Potentiometer
24 V DC ± 20 %
830...880...980mW at I_{OUT} = 20 mA
Fast/slow: 2-/3-/4-conductor: 1.2s/2.3s; potentiometer: 0.5s/1.2s
0 °C...55 °C
CE; cULus; EAC; GL

DIN EN 50178, DIN EN 61000-4-2
EN 55011, EN 61000-6
300 V
4 kV
2 kV_{eff} / 5 s
III
2
≥ 3 mm

Dimensions

Clamping range (nominal / min. / max.)
Depth x width x height

Note

Screw connection

2.5 / 0.5 / 2.5
112.4 / 17.5 /

Ordering data

Screw connection

Type	Qty.	Order No.
WAS5 PRO RTD 1000	1	8679490000

Note

Accessories

Note

Cross-connector for power supplies and markers – refer to Accessories

PRO RTD 1000

Switch position / setting options

Choice of inputs			Switch 1		
Input			1	2	3
PT1000	2-wire	<input checked="" type="checkbox"/>	<input checked="" type="checkbox"/>	<input checked="" type="checkbox"/>	<input checked="" type="checkbox"/>
PT1000	3-wire	<input type="checkbox"/>	<input checked="" type="checkbox"/>	<input checked="" type="checkbox"/>	<input checked="" type="checkbox"/>
PT1000	4-wire	<input checked="" type="checkbox"/>	<input type="checkbox"/>	<input checked="" type="checkbox"/>	<input checked="" type="checkbox"/>
R	2-wire	<input type="checkbox"/>	<input type="checkbox"/>	<input type="checkbox"/>	<input checked="" type="checkbox"/>
NI1000	2-wire	<input checked="" type="checkbox"/>	<input checked="" type="checkbox"/>	<input type="checkbox"/>	<input type="checkbox"/>
NI1000	3-wire	<input type="checkbox"/>	<input checked="" type="checkbox"/>	<input type="checkbox"/>	<input type="checkbox"/>
NI1000	4-wire	<input checked="" type="checkbox"/>	<input type="checkbox"/>	<input type="checkbox"/>	<input type="checkbox"/>
Potentiometer		<input type="checkbox"/>	<input type="checkbox"/>	<input type="checkbox"/>	<input type="checkbox"/>

= on
 = off

Choice of outputs			Switch 2	
Output			6	7
0...10 V		<input checked="" type="checkbox"/>	<input type="checkbox"/>	<input type="checkbox"/>
0...5 V		<input checked="" type="checkbox"/>	<input checked="" type="checkbox"/>	<input type="checkbox"/>
0...20 mA		<input type="checkbox"/>	<input type="checkbox"/>	<input type="checkbox"/>
4...20 mA		<input type="checkbox"/>	<input checked="" type="checkbox"/>	<input type="checkbox"/>

Switch on the manual fine adjustments		S. 1
Man. adjustment		8
off	<input type="checkbox"/>	
on	<input checked="" type="checkbox"/>	

Choice of step response time		S. 2
Step response time		8
slow	<input checked="" type="checkbox"/>	
fast	<input type="checkbox"/>	

Accuracy, slow/fast step response time						
PT 100, Ni 100: 0.3 % from measuring range 0.8 %						
from measuring range < 100 K / 0.3 K / 0.8 K						
Potentiometer: 0.2 % from end value / 0.3 %						
Resistance: 0.2 % from end value / 0.3 %						

Temperature coefficient			
Measuring range ≥ 200 K		≤ 200 ppm / °C	
100 K ≤ Measuring range < 200 K		≤ 250 ppm / °C	
40 K ≤ Measuring range < 100 K		≤ 400 ppm / °C	

Adjustment example for zero and span					
Temperature adjustment:					
Output	4...20 mA				
DIP switch	-10 °C...+110 °C				
Span	75...110 °C				
Range 120 °C					
Adjustment range	± 12.5 %				

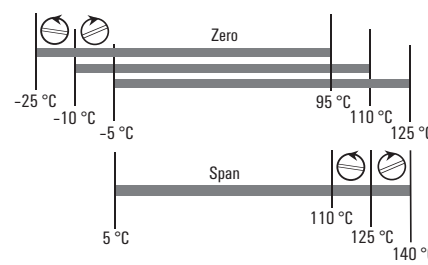

Wavetool adjustment tool
This service tool enables quick and straightforward configuration of the WAVEANALOG PRO.
Internet download:
<http://www.weidmueller.com>

Choice of minimum input size						
S _{min}	R _{min}	Poti _{min}	Switch 1			
0 °C	0 Ω	0 %	4	5	6	7
-10 °C	100 Ω	10 %	<input checked="" type="checkbox"/>	<input checked="" type="checkbox"/>	<input checked="" type="checkbox"/>	<input type="checkbox"/>
-20 °C	200 Ω	20 %	<input checked="" type="checkbox"/>	<input checked="" type="checkbox"/>	<input type="checkbox"/>	<input type="checkbox"/>
-25 °C	200 Ω	25 %	<input checked="" type="checkbox"/>	<input checked="" type="checkbox"/>	<input type="checkbox"/>	<input type="checkbox"/>
-30 °C	300 Ω	30 %	<input checked="" type="checkbox"/>	<input type="checkbox"/>	<input checked="" type="checkbox"/>	<input checked="" type="checkbox"/>
-40 °C	400 Ω	40 %	<input checked="" type="checkbox"/>	<input type="checkbox"/>	<input checked="" type="checkbox"/>	<input type="checkbox"/>
-50 °C	500 Ω	50 %	<input checked="" type="checkbox"/>	<input type="checkbox"/>	<input type="checkbox"/>	<input checked="" type="checkbox"/>
-60 °C	600 Ω	60 %	<input checked="" type="checkbox"/>	<input type="checkbox"/>	<input type="checkbox"/>	<input type="checkbox"/>
-70 °C	700 Ω	70 %	<input type="checkbox"/>	<input checked="" type="checkbox"/>	<input checked="" type="checkbox"/>	<input checked="" type="checkbox"/>
-80 °C	800 Ω	80 %	<input type="checkbox"/>	<input checked="" type="checkbox"/>	<input checked="" type="checkbox"/>	<input type="checkbox"/>
-90 °C	900 Ω		<input type="checkbox"/>	<input checked="" type="checkbox"/>	<input type="checkbox"/>	<input checked="" type="checkbox"/>
-100 °C	1000 Ω		<input type="checkbox"/>	<input checked="" type="checkbox"/>	<input type="checkbox"/>	<input type="checkbox"/>
-150 °C	1500 Ω		<input type="checkbox"/>	<input type="checkbox"/>	<input checked="" type="checkbox"/>	<input checked="" type="checkbox"/>
-200 °C	2000 Ω		<input type="checkbox"/>	<input type="checkbox"/>	<input checked="" type="checkbox"/>	<input type="checkbox"/>
Special area			<input type="checkbox"/>	<input type="checkbox"/>	<input type="checkbox"/>	<input checked="" type="checkbox"/>

Choice of measuring range							
T	R	Poti	Switch 2				
			1	2	3	4	5
40 K	200 Ω	20 %	<input checked="" type="checkbox"/>	<input checked="" type="checkbox"/>	<input checked="" type="checkbox"/>	<input checked="" type="checkbox"/>	<input checked="" type="checkbox"/>
50 K	250 Ω	25 %	<input checked="" type="checkbox"/>	<input checked="" type="checkbox"/>	<input checked="" type="checkbox"/>	<input checked="" type="checkbox"/>	<input type="checkbox"/>
60 K	300 Ω	30 %	<input checked="" type="checkbox"/>	<input checked="" type="checkbox"/>	<input checked="" type="checkbox"/>	<input type="checkbox"/>	<input checked="" type="checkbox"/>
70 K	350 Ω	35 %	<input checked="" type="checkbox"/>	<input checked="" type="checkbox"/>	<input checked="" type="checkbox"/>	<input type="checkbox"/>	<input type="checkbox"/>
80 K	400 Ω	40 %	<input checked="" type="checkbox"/>	<input checked="" type="checkbox"/>	<input type="checkbox"/>	<input checked="" type="checkbox"/>	<input checked="" type="checkbox"/>
90 K	450 Ω	45 %	<input checked="" type="checkbox"/>	<input checked="" type="checkbox"/>	<input type="checkbox"/>	<input checked="" type="checkbox"/>	<input type="checkbox"/>
100 K	500 Ω	50 %	<input checked="" type="checkbox"/>	<input checked="" type="checkbox"/>	<input type="checkbox"/>	<input type="checkbox"/>	<input checked="" type="checkbox"/>
110 K	550 Ω	55 %	<input checked="" type="checkbox"/>	<input checked="" type="checkbox"/>	<input type="checkbox"/>	<input type="checkbox"/>	<input type="checkbox"/>
120 K	600 Ω	60 %	<input checked="" type="checkbox"/>	<input type="checkbox"/>	<input checked="" type="checkbox"/>	<input checked="" type="checkbox"/>	<input checked="" type="checkbox"/>
125 K	625 Ω	62.50 %	<input checked="" type="checkbox"/>	<input type="checkbox"/>	<input type="checkbox"/>	<input checked="" type="checkbox"/>	<input type="checkbox"/>
130 K	650 Ω	65 %	<input checked="" type="checkbox"/>	<input type="checkbox"/>	<input checked="" type="checkbox"/>	<input checked="" type="checkbox"/>	<input checked="" type="checkbox"/>
140 K	700 Ω	70 %	<input checked="" type="checkbox"/>	<input type="checkbox"/>	<input checked="" type="checkbox"/>	<input type="checkbox"/>	<input type="checkbox"/>
150 K	750 Ω	75 %	<input checked="" type="checkbox"/>	<input type="checkbox"/>	<input type="checkbox"/>	<input checked="" type="checkbox"/>	<input checked="" type="checkbox"/>
160 K	800 Ω	80 %	<input checked="" type="checkbox"/>	<input type="checkbox"/>	<input type="checkbox"/>	<input type="checkbox"/>	<input type="checkbox"/>
170 K	850 Ω	85 %	<input checked="" type="checkbox"/>	<input type="checkbox"/>	<input type="checkbox"/>	<input type="checkbox"/>	<input checked="" type="checkbox"/>
180 K	900 Ω	90 %	<input checked="" type="checkbox"/>	<input type="checkbox"/>	<input type="checkbox"/>	<input type="checkbox"/>	<input type="checkbox"/>
190 K	950 Ω	95 %	<input type="checkbox"/>	<input checked="" type="checkbox"/>	<input checked="" type="checkbox"/>	<input checked="" type="checkbox"/>	<input checked="" type="checkbox"/>
200 K	1000 Ω	100 %	<input type="checkbox"/>	<input checked="" type="checkbox"/>	<input checked="" type="checkbox"/>	<input checked="" type="checkbox"/>	<input type="checkbox"/>
250 K	1250 Ω	-	<input type="checkbox"/>	<input checked="" type="checkbox"/>	<input checked="" type="checkbox"/>	<input checked="" type="checkbox"/>	<input checked="" type="checkbox"/>
300 K	1500 Ω	-	<input type="checkbox"/>	<input type="checkbox"/>	<input checked="" type="checkbox"/>	<input type="checkbox"/>	<input type="checkbox"/>
350 K	1750 Ω	-	<input type="checkbox"/>	<input type="checkbox"/>	<input checked="" type="checkbox"/>	<input type="checkbox"/>	<input checked="" type="checkbox"/>
400 K	2000 Ω	-	<input type="checkbox"/>	<input type="checkbox"/>	<input checked="" type="checkbox"/>	<input checked="" type="checkbox"/>	<input type="checkbox"/>
450 K	2250 Ω	-	<input type="checkbox"/>	<input type="checkbox"/>	<input type="checkbox"/>	<input type="checkbox"/>	<input checked="" type="checkbox"/>
500 K	2500 Ω	-	<input type="checkbox"/>	<input type="checkbox"/>	<input checked="" type="checkbox"/>	<input type="checkbox"/>	<input type="checkbox"/>
550 K	2750 Ω	-	<input type="checkbox"/>	<input type="checkbox"/>	<input type="checkbox"/>	<input checked="" type="checkbox"/>	<input checked="" type="checkbox"/>
600 K	3000 Ω	-	<input type="checkbox"/>	<input type="checkbox"/>	<input type="checkbox"/>	<input checked="" type="checkbox"/>	<input type="checkbox"/>
650 K	3250 Ω	-	<input type="checkbox"/>	<input type="checkbox"/>	<input checked="" type="checkbox"/>	<input checked="" type="checkbox"/>	<input checked="" type="checkbox"/>
700 K	3500 Ω	-	<input type="checkbox"/>	<input type="checkbox"/>	<input type="checkbox"/>	<input checked="" type="checkbox"/>	<input type="checkbox"/>
750 K	3750 Ω	-	<input type="checkbox"/>	<input type="checkbox"/>	<input type="checkbox"/>	<input checked="" type="checkbox"/>	<input checked="" type="checkbox"/>
800 K	4000 Ω	-	<input type="checkbox"/>	<input type="checkbox"/>	<input type="checkbox"/>	<input checked="" type="checkbox"/>	<input type="checkbox"/>
850 K	4250 Ω	-	<input type="checkbox"/>	<input type="checkbox"/>	<input type="checkbox"/>	<input type="checkbox"/>	<input checked="" type="checkbox"/>
900 K	4500 Ω	-	<input type="checkbox"/>	<input type="checkbox"/>	<input type="checkbox"/>	<input type="checkbox"/>	<input type="checkbox"/>

Signal converters

D

RTD signal isolator/converter

- Universally adjustable via DIP switch
- 3-way isolation
- Linearisation
- Power supply can be cross-connected using plug-in jumpers.

PRO RTD Cu

UL Class I, Div.2

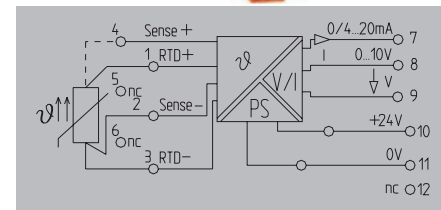
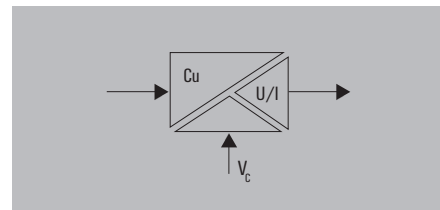

Technical data

Input	3/4-wired, Cu 10, Cu 25, Cu 50, Cu 100 Adjustable from -200...+260°C
Output	0...20 mA, 4...20 mA / 0...10 V max. 100 µA / max. 0.05 V ≥ 1 kΩ / ≤ 600 Ω LED flashing (output value: > 20 mA, >10 V) ± 12.5% of FSR Module active: LED on/ wire breakage: LED flashing/ Error: LED off
General data	DIP switch 24 V DC ± 20 % 880...980...1030mW at I _{nom} = 20 mA Fast: 1.2 s/ slow: 2.2 s 0 °C...55 °C CE; cULus; cULusEX; EAC
Insulation coordination	DIN EN 50178, DIN EN 61000-4-2 EN 55011, EN 61000-6 300 V 4 kV 2 kV _{eff} / 5 s III 2 ≥ 3 mm
Dimensions	Clamping range (nominal / min. / max.) 2.5 / 0.5 / 2.5 Depth x width x height 112.4 / 17.5 /
Note	

Ordering data

Type	Qty.	Order No.
WAS5 PRO RTD Cu	1	8638950000

Note

Accessories

Note
Cross-connector for power supplies and markers – refer to Accessories

Connection	Selection of connection Switch 1		Selection of sensor Switch 1		
	1		Type	2	3
3-wire	■		Cu 10	■	■
4-wire	□		Cu 25	■	□
			Cu 50	□	■
			Cu 100	□	□

θ min	Selection of minimum input values Switch 1			
	4	5	6	7
- 0 °C	■	■	■	■
- 10 °C	■	■	■	□
- 20 °C	■	■	□	■
- 25 °C	■	■	□	□
- 30 °C	■	□	■	■
- 40 °C	■	□	■	□
- 50 °C	■	□	□	■
- 60 °C	■	□	□	□
- 70 °C	□	■	■	■
- 80 °C	□	■	■	□
- 90 °C	□	■	□	■
- 100 °C	□	■	□	□
- 150 °C	□	□	■	■
- 200 °C	□	□	■	□
special range	□	□	□	□

Span	Selection of the measurement range Switch 2				
	1	2	3	4	5
40 K	■	■	■	■	■
50 K	■	■	■	■	□
60 K	■	■	■	□	■
70 K	■	■	■	□	□
80 K	■	■	□	■	■
90 K	■	■	□	■	□
100 K	■	■	□	□	■
110 K	■	■	□	□	□
120 K	■	□	■	■	■
125 K	■	□	■	■	□
130 K	■	□	■	□	■
140 K	■	□	■	□	□
150 K	■	□	□	■	■
160 K	■	□	□	■	□
170 K	■	□	□	□	■
180 K	■	□	□	□	□
190 K	□	■	■	■	■
200 K	□	■	■	■	□
210 K	□	■	■	□	■
220 K	□	■	■	□	□
230 K	□	■	□	■	■
240 K	□	■	□	■	□
250 K	□	■	□	□	■
260 K	□	■	□	□	□
270 K	□	□	■	■	■
280 K	□	□	■	■	□
290 K	□	□	■	□	■
300 K	□	□	■	□	□
350 K	□	□	□	■	■
400 K	□	□	□	■	□
450 K	□	□	□	□	■
460 K	□	□	□	□	□

Connection	Selection of Output Switch 2		Switching on the manual fine adjustment Switch 1	
	6	7	man adj.	8
0 ... 10 V	■	□		
0 ... 20 mA	□	□	off	□
4 ... 20 mA	□	■	on	■

Time of step response	Selection of step set time Switch 2	
	8	
slow	■	■ = on
fast	□	□ = off

WAVESERIES - Temperature measuring transducers

RTD, 4-wire converter

- 4-wire connection
- Adjustable temperature range from -200 °C...+800 °C
- Power supply can be cross-connected using plug-in jumpers
- No galvanic isolation between input and output circuits

PT100 / 4 0 (4)...20 mA



PT100 / 4 0...10 V

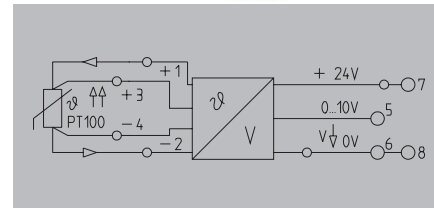
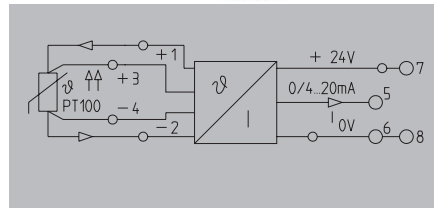
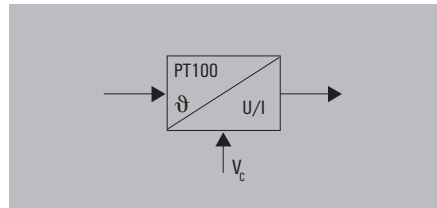

Technical data

Input	PT100 / 2-/3-/4-wire	PT100 / 2-/3-/4-wire
Sensor	1.45 mA	1.45 mA
Sensor supply		
Output		
Output voltage / Output current	/ 0...20 mA, 4...20 mA	0...10 V /
Load impedance, voltage/current	/ ≤ 500 Ω	≥ 1 kΩ /
General data		
Configuration	DIP switch, Potentiometer	DIP switch, Potentiometer
Supply voltage / Current consumption	24 V DC ± 20 % /	24 V DC ± 20 % /
Ambient temperature	0 °C...55 °C	0 °C...55 °C
Accuracy	100K ≤ MB < 600K: 0.1 %; MB ≥ 600K: 0.2 %; of measuring range	100K ≤ MB < 600K: 0.1 %; MB ≥ 600K: 0.2 %; of measuring range
Approvals	CE; CSA; cULus; EAC	CE; CSA; cULus; EAC
Standards	DIN EN 50178, DIN EN 61000-4-2	DIN EN 50178, DIN EN 61000-4-2
EMC standards	EN 55011, EN 61000-6	EN 55011, EN 61000-6

Dimensions	Tension clamp connection	Tension clamp connection
Clamping range (nominal / min. / max.)	1.5/0.5/2.5	1.5/0.5/2.5
Depth x width x height	112.4/12.5	112.4/12.5
Note		

Ordering data	Type	Qty.	Order No.
Adjustable from -200...+800°C	WTZ4 PT100/4 C 0/4-20mA	1	8432280000

Type	Qty.	Order No.
WTZ4 PT100/4 C 0/4-20mA	1	8432280000

Type	Qty.	Order No.
WTZ4 PT100/4 V 0-10V	1	8432250000

Note	Cross-connectors for power supplies and markers - refer to WAVESERIES accessories	Specify temperature range for special calibrations.
------	---	---

Applications

Example for Zero and Span	Temperature adjustment
	Tmin -10 °C
	Span 75...110 °C
	Span 95 °C
	Adjustment of Span +25 %

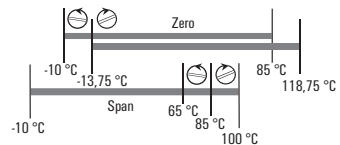

Temperature coefficient
Measurement range ≥ 200 K ≤ 200 ppm/°C (typ. 80 ppm/°C)
100 K ≤ Measurement range < 200 K ≤ 205 ppm/°C (typ. 90 ppm/°C)
40 K ≤ Measurement range < 100 K ≤ 450 ppm/°C (typ. 180 ppm/°C)

- Aids**
- Voltage supply 24 V DC, 50 mA
 - Simulator for PT 100 or precision-resistance-decade
 - Ampere-/voltmeter which can be calibrated to an accuracy of > 0.1% of the end value.

Switch position/setting options

Tmin	1	2	3	Span	4	5	6
0 °C	■	■	■	40...50 °C	■	■	■
-10 °C	■	■	□	50...75 °C	■	■	□
-20 °C	■	□	■	75...110 °C	■	□	■
-40 °C	■	□	□	110...165 °C	■	□	□
-60 °C	□	■	■	165...245 °C	■	■	■
-80 °C	□	■	□	245...360 °C	■	□	■
-100 °C	□	□	■	360...540 °C	■	■	■
-200 °C	□	□	□	540...800 °C	■	□	■

¹⁾ only modules with current output

■ = on
□ = off

Signal converters

D

WAVESERIES - Temperature measuring transducers

RTD, 3-wire converter

- 3-wire connection
- Adjustable temperature range from -200 °C...+800 °C
- Power supply can be cross-connected using plug-in jumpers
- No galvanic isolation between input and output circuits

PT100 / 3 0...10 V



PT100 / 3 0 (4)...20 mA

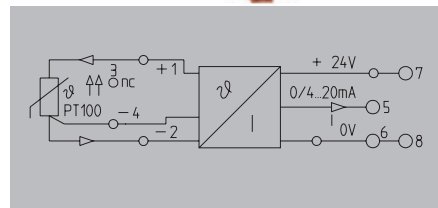
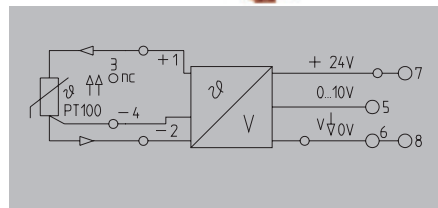
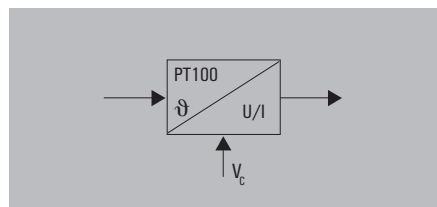

Technical data

Input	PT100/3-wire	PT100/3-wire
Sensor	PT100/3-wire	PT100/3-wire
Sensor supply	1.45 mA	1.45 mA
Output		
Output voltage / Output current	0...10 V /	/ 0...20 mA, 4...20 mA
Load impedance, voltage/current	≥ 1 kΩ /	/ ≤ 500 Ω
General data		
Configuration	DIP switch, Potentiometer	DIP switch, Potentiometer
Supply voltage / Current consumption	24 V DC ± 20 % /	24 V DC ± 20 % /
Ambient temperature	0 °C...55 °C	0 °C...55 °C
Accuracy	± 0.5 % of measuring range	± 0.5 % of measuring range
Approvals	CE, CSA, cULus, EAC	CE, CSA, cULus, EAC
Standards	DIN EN 50178, DIN EN 61000-4-2	DIN EN 50178, DIN EN 61000-4-2
EMC standards	EN 55011, EN 61000-6	EN 55011, EN 61000-6

Dimensions

Dimensions	Tension clamp connection	Tension clamp connection	Tension clamp connection
Clamping range (nominal / min. / max.)	1.5/0.5/2.5	1.5/0.5/2.5	1.5/0.5/2.5
Depth x width x height	112.4/12.5	112.4/12.5	112.4/12.5
Note			

Ordering data

Ordering data	Type	Qty.	Order No.	Type	Qty.	Order No.
Adjustable from -200...+800°C	WTZ4 PT100/3 V 0-10V	1	8432130000	WTZ4 PT100/3 C 0/4-20mA	1	8432160000
Tension-clamp connection						

Note	Note	Note
	Specify temperature range for special calibrations.	Cross-connectors for power supplies and markers - refer to WAVESERIES accessories

Applications

Example for Zero and Span

Temperature adjustment	Temperature coefficient
Tmin	-10 °C
Span	75...110 °C
Span	95 °C
Adjustment of Span	+25 %

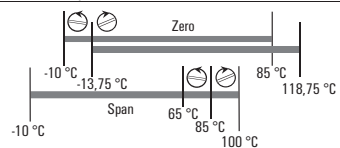

Temperature coefficient
Measurement range ≥ 200 K ≤ 200 ppm/°C (typ. 80 ppm/°C)
100 K ≤ Measurement range < 200 K ≤ 205 ppm/°C (typ. 90 ppm/°C)
40 K ≤ Measurement range < 100 K ≤ 450 ppm/°C (typ. 180 ppm/°C)

Aids

- Voltage supply 24 V DC, 50 mA
- Simulator for PT 100 or precision-resistance-decade
- Ampere-/voltmeter which can be calibrated to an accuracy of > 0.1% of the end value.

Switch position/setting options

Tmin	1	2	3	Span	4	5	6
0 °C	■	■	■	40...50 °C	■	■	■
-10 °C	■	■	□	50...75 °C	■	■	□
-20 °C	■	□	■	75...110 °C	■	□	■
-40 °C	■	□	□	110...165 °C	■	□	□
-60 °C	■	■	■	165...245 °C	■	■	■
-80 °C	■	■	■	245...360 °C	■	■	■
-100 °C	■	■	■	360...540 °C	■	■	■
-200 °C	■	□	□	540...800 °C	■	□	□

Output ¹⁾	PT 100			
Range	7	8	9	10
0...20 mA	□	2-Wire	■	■
4...20 mA	■	3-Wire	■	■
		4-Wire	■	□

¹⁾ only modules with current output

■ = on
□ = off

WAVESERIES - Temperature measuring transducers

RTD, 2-wire converter

- 2-wire connection
- Adjustable temperature range from -200 °C...+800 °C
- Power supply can be cross-connected using plug-in jumpers
- No galvanic isolation between input and output circuits

PT100 / 2 0...10 V



PT100/2 0 (4)...20 mA

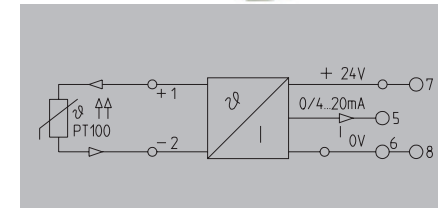
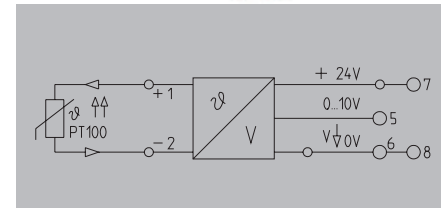
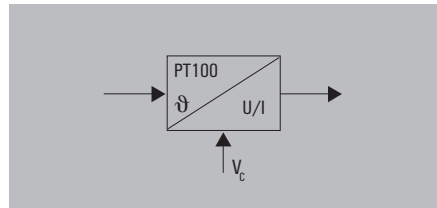

Technical data

Input
Sensor
Sensor supply
Output
Output voltage / Output current
Load impedance, voltage/current
General data
Configuration
Supply voltage / Current consumption
Ambient temperature
Accuracy
Approvals
Standards
EMC standards

PT100/2-wire
1.45 mA
0...10 V /
≥ 1 kΩ /
DIP switch, Potentiometer
24 V DC ± 20 % / < 38 mA @ I _{out} = 20 mA
0 °C...55 °C
± 0.5 % of measuring range
CE; CSA; cULus; EAC
DIN EN 50178, DIN EN 61000-4-2
EN 55011, EN 61000-6

PT100/2-wire
1.45 mA
/ 0...20 mA, 4...20 mA
/ ≤ 500 Ω
DIP switch, Potentiometer
24 V DC ± 20 % / < 48 mA @ I _{out} = 20 mA
0 °C...55 °C
± 0.5 % of measuring range
CE; CSA; cULus; EAC
DIN EN 50178, DIN EN 61000-4-2
EN 55011, EN 61000-6

Dimensions
Clamping range (nominal / min. / max.)
Depth x width x height
Note

Tension clamp connection	Tension clamp connection
1.5/0.5/2.5	1.5/0.5/2.5
112.4/12.5	112.4/12.5

Tension clamp connection	Tension clamp connection
1.5/0.5/2.5	1.5/0.5/2.5
112.4/12.5	112.4/12.5

Ordering data

Adjustable from -200...+800°C	Tension-clamp connection
-------------------------------	--------------------------

Type	Qty.	Order No.
WTZ4 PT100/2 V 0-10V	1	8432190000

Type	Qty.	Order No.
WTZ4 PT100/2 C 0/4-20mA	1	8432220000

Note

Specify temperature range for special calibrations.

Cross-connectors for power supplies and markers - refer to WAVESERIES accessories

Applications

Example for Zero and Span	
Temperature adjustment	
Tmin	-10 °C
Span	75...110 °C
Span	95 °C
Adjustment of Span	+25 %

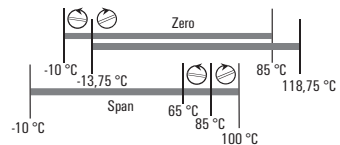

Temperature coefficient	
Measurement range ≥ 200 K	≤ 200 ppm/°C (typ. 80 ppm/°C)
100 K ≤ Measurement range < 200 K	≤ 205 ppm/°C (typ. 90 ppm/°C)
40 K ≤ Measurement range < 100 K	≤ 450 ppm/°C (typ. 180 ppm/°C)

- Aids**
- Voltage supply 24 V DC, 50 mA
 - Simulator for PT 100 or precision-resistance-decade
 - Ampere-/voltmeter which can be calibrated to an accuracy of > 0.1% of the end value.

Switch position/setting options

Tmin	1	2	3	Span	4	5	6
0 °C	<input checked="" type="checkbox"/>	<input checked="" type="checkbox"/>	<input checked="" type="checkbox"/>	40...50 °C	<input checked="" type="checkbox"/>	<input checked="" type="checkbox"/>	<input checked="" type="checkbox"/>
-10 °C	<input checked="" type="checkbox"/>	<input checked="" type="checkbox"/>	<input type="checkbox"/>	50...75 °C	<input checked="" type="checkbox"/>	<input checked="" type="checkbox"/>	<input type="checkbox"/>
-20 °C	<input checked="" type="checkbox"/>	<input type="checkbox"/>	<input type="checkbox"/>	75...110 °C	<input type="checkbox"/>	<input type="checkbox"/>	<input type="checkbox"/>
-40 °C	<input type="checkbox"/>	<input type="checkbox"/>	<input type="checkbox"/>	110...165 °C	<input type="checkbox"/>	<input type="checkbox"/>	<input type="checkbox"/>
-60 °C	<input type="checkbox"/>	<input checked="" type="checkbox"/>	<input type="checkbox"/>	165...245 °C	<input type="checkbox"/>	<input type="checkbox"/>	<input type="checkbox"/>
-80 °C	<input type="checkbox"/>	<input type="checkbox"/>	<input checked="" type="checkbox"/>	245...360 °C	<input type="checkbox"/>	<input type="checkbox"/>	<input type="checkbox"/>
-100 °C	<input type="checkbox"/>	<input type="checkbox"/>	<input type="checkbox"/>	360...540 °C	<input type="checkbox"/>	<input type="checkbox"/>	<input type="checkbox"/>
-200 °C	<input type="checkbox"/>	<input type="checkbox"/>	<input type="checkbox"/>	540...800 °C	<input type="checkbox"/>	<input type="checkbox"/>	<input type="checkbox"/>
Output ¹⁾	7			PT 100	8	9	10
Range				2-Wire	<input checked="" type="checkbox"/>	<input checked="" type="checkbox"/>	<input checked="" type="checkbox"/>
0...20 mA	<input type="checkbox"/>			3-Wire	<input type="checkbox"/>	<input type="checkbox"/>	<input type="checkbox"/>
4...20 mA	<input checked="" type="checkbox"/>			4-Wire	<input type="checkbox"/>	<input type="checkbox"/>	<input type="checkbox"/>

¹⁾ only modules with current output

= on
 = off

Signal converters

D

WAVESERIES - Temperature measuring transducer

Thermal converter type:

K, J, T, E, N, R, S, B

- 3-way isolation
- Internal cold-junction compensation
- Power supply can be cross-connected using plug-in jumpers
- Suitable for insulated and uninsulated thermocouples
- WAVETOOL software helps with configuration, download at www.weidmueller.com

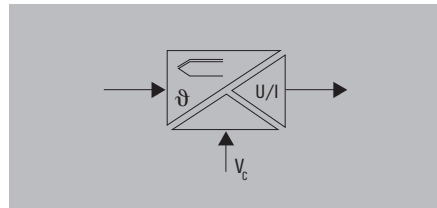

PRO Thermo

UL Class I, Div. 2

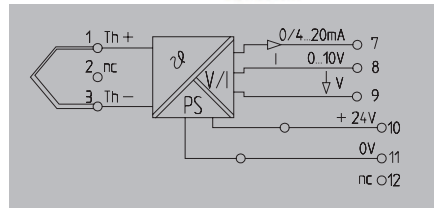

Technical data

Input

Sensor
Temperature input range

Output

Output voltage / Output current
Load impedance, voltage/current
Offset current / Offset voltage
Line resistance in measuring circuit
Sensor error detection
Fine adjustment
Status indicator

General data

Configuration
Supply voltage
Power consumption
Step response time
Current-carrying capacity of cross-connect.
Ambient temperature
Storage temperature
Default setting
Approvals
Insulation coordination
Standards
EMC standards
Rated voltage
Impulse withstand voltage
Insulation voltage
Overvoltage category
Pollution degree
Clearance & creepage distances

Dimensions

Clamping range (nominal / min. / max.) mm²
Depth x width x height mm

Note

Ordering data

Screw connection
Tension-clamp connection

Note

Accessories

Note

Thermo element (IEC 584) type: K, J, T, E, N, R, S, B

-200...+1820 °C

0...10 V / 0...20 mA, 4...20 mA

≥ 1 kΩ / ≤ 600 Ω

max. 100 μA / max. 0.05 V

50 Ω

LED flashing (output value: > 20 mA, > 10 V)

± 5% (switchable)

Module active: LED on/ wire breakage: LED flashing/
Error: LED off

DIP switch

24 V DC ± 20 %

800...850...950 mW at I_{OUT} = 20 mA

without filter: max. 1.4 s; with filter: max. 7.5 s

≤ 2 A

0 °C...55 °C

-20 °C...85 °C

Type K; 0...1000°C; 4...20mA; filter: off; man. calibration: off

CE: cULus; cULusEX; EAC; GL

DIN EN 50178, DIN EN 61000-4-2

EN 55011, EN 61000-6

300

4 kV

2 kV_{eff} / 5 s

III

2

≥ 3 mm

Screw connection Tension clamp connection

2.5/0.5/2.5 1.5/0.5/2.5

112.4/17.5 112.4/17.5

Type Qty. Order No.

WAS5 PRO Thermo 1 **8560720000**

WAZ5 PRO Thermo 1 **8560730000**

Cross-connector for power supplies and markers – refer to Accessories

Typ	Select of thermocoupler SW1			Selection of minimum temperature SW1				
	1	2	3	∅ min	1	2	3	4
K	■	■	■	0 °C	■	■	■	■
J	□	■	■	-10 °C	■	■	■	□
T	■	□	■	-20 °C	■	■	□	■
E	□	□	■	-30 °C	■	■	□	□
N	■	■	□	-40 °C	■	■	■	□
R	□	■	□	-50 °C	■	□	■	□
S	■	□	□	-100 °C	■	□	□	■
B	□	□	□	-150 °C	■	□	□	□
				-200 °C	□	■	■	■
				+50 °C	□	■	■	□
				+100 °C	□	■	■	■
				+150 °C	□	■	■	□
				+200 °C	□	□	■	■
				+250 °C	□	□	■	□
				+500 °C	□	□	□	■
				Special range	□	□	□	□

Span	Selection of temperature span SW2					Selection of output Switch 2		
	1	2	3	4	5	Output	6	7
100 °C	■	■	■	■	■	0...10 V	■	□
150 °C	■	■	■	■	□	0...20 mA	□	□
200 °C	■	■	■	■	□	4...20 mA	□	■
250 °C	■	■	■	□	□			
300 °C	■	■	□	■	■			
350 °C	■	■	□	■	□			
400 °C	■	■	□	□	■			
450 °C	■	■	□	□	□			
500 °C	■	□	■	■	■			
550 °C	■	□	■	■	□			
600 °C	■	□	■	■	■			
650 °C	■	□	■	□	□			
700 °C	■	□	■	■	■			
750 °C	■	□	■	■	□			
800 °C	■	□	□	■	■			
850 °C	■	□	□	□	□			
900 °C	□	■	■	■	■			
950 °C	□	■	■	■	□			
1000 °C	□	■	■	■	■			
1050 °C	□	■	■	■	□			
1100 °C	□	■	■	■	■			
1150 °C	□	■	■	■	□			
1200 °C	□	■	□	■	■			
1250 °C	□	■	□	■	□			
1300 °C	□	□	■	■	■			
1350 °C	□	□	■	■	□			
1400 °C	□	□	■	■	■			
1450 °C	□	□	■	■	□			
1500 °C	□	□	■	■	■			
1600 °C	□	□	■	■	□			
1700 °C	□	□	■	■	■			
1800 °C	□	□	■	■	□			

Switching on the manual fine adjustment SW 2	
man. adjust.	6
off	□
on	■

Switching on the filter function SW 2	
Filter	8
off	□
on	■

■ = on
□ = off

Accuracy

K	-200 °C ... -150 °C	± (5K + 0.1 % of set range)
	-150 °C ... 1200 °C	± (3K + 0.1 % of set range)
	1200 °C ... 1372 °C	± (4K + 0.1 % of set range)
J	-200 °C ... -150 °C	± (4K + 0.1 % of set range)
	-150 °C ... 1200 °C	± (3K + 0.1 % of set range)
T	-200 °C ... -150 °C	± (5K + 0.1 % of set range)
	-150 °C ... 400 °C	± (3K + 0.1 % of set range)
E	-200 °C ... -150 °C	± (4K + 0.1 % of set range)
	-150 °C ... 1000 °C	± (3K + 0.1 % of set range)
N	-200 °C ... -150 °C	± (6K + 0.1 % of set range)
	-150 °C ... 1300 °C	± (3K + 0.1 % of set range)
R	-50 °C ... 200 °C	± (10K + 0.1 % of set range)
	200 °C ... 1760 °C	± (6K + 0.1 % of set range)
S	-50 °C ... 200 °C	± (10K + 0.1 % of set range)
	200 °C ... 1760 °C	± (6K + 0.1 % of set range)
B	50 °C ... 250 °C	± (25K + 0.1 % of set range)
	250 °C ... 500 °C	± (10K + 0.1 % of set range)
	500 °C ... 1820 °C	± (6K + 0.1 % of set range)

WAVESERIES - Temperature measuring transducer

Thermal converter type:
K, J, T, E, N, R, S, B

- No calibration necessary
- Internal cold-junction compensation
- Output signal selectable
- Power supply can be cross-connected using plug-in jumpers
- Suitable for insulated thermocouples
- No galvanic isolation between input and output circuits

Thermo Select

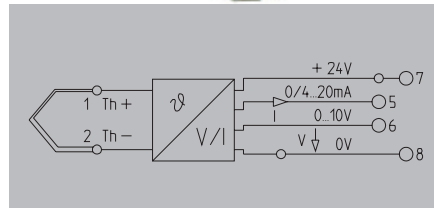
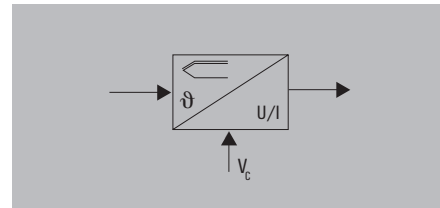

Technical data

Input	
Sensor	Thermo element (IEC 584) type: K,J,T,E,N,R,S,B
Temperature input range	-200...+1820 °C
Output	
Output voltage / Output current	0...10 V / 0...20 mA, 4...20 mA
Load impedance, voltage/current	/ ≤ 500 Ω
Temperature coefficient	± (200 ppm from the span + 0.075 K)/K
Step response time	without filter: 1.1 s; with filter: 6 s
Sensor error detection	LED flashing (output value: > 20 mA, >10 V)
General data	
Configuration	DIP switch
Supply voltage	24 V DC ± 20 %
Current consumption	< 38 mA @ I _{max} = 20 mA
Current-carrying capacity of cross-connect.	≤ 2 A
Ambient temperature	0 °C...55 °C
Storage temperature	-20 °C...85 °C
Approvals	CE, CSA, cULus, EAC
Insulation coordination	
Standards	DIN EN 50178, DIN EN 61000-4-2
EMC standards	EN 55011, EN 61000-6

SW 1	
Type	1 2 3
K	■ ■ ■
J	□ ■ ■
T	■ □ ■
E	□ □ ■
N	■ ■ □
R	□ ■ □
S	■ □ □
B	□ □ □
SW 2	
Span	1 2 3 4 5
100 °C	■ ■ ■ ■ ■
150 °C	■ ■ ■ ■ □
200 °C	■ ■ ■ □ □
250 °C	■ ■ □ □ □
300 °C	■ ■ □ □ □
350 °C	■ ■ □ □ □
400 °C	■ ■ □ □ □
450 °C	■ ■ □ □ □
500 °C	■ □ □ □ □
550 °C	■ □ □ □ □
600 °C	■ □ □ □ □
650 °C	■ □ □ □ □
700 °C	■ □ □ □ □
750 °C	■ □ □ □ □
800 °C	■ □ □ □ □
850 °C	■ □ □ □ □
900 °C	■ □ □ □ □
950 °C	■ □ □ □ □
1000 °C	■ □ □ □ □
1050 °C	■ □ □ □ □
1100 °C	■ □ □ □ □
1150 °C	■ □ □ □ □
1200 °C	■ □ □ □ □
1250 °C	■ □ □ □ □
1300 °C	■ □ □ □ □
1350 °C	■ □ □ □ □
1400 °C	■ □ □ □ □
1450 °C	■ □ □ □ □
1500 °C	■ □ □ □ □
1600 °C	■ □ □ □ □
1700 °C	■ □ □ □ □
1800 °C	■ □ □ □ □
SW 1	
Tmin	4 5 6 7
0 °C	■ ■ ■ ■
-10 °C	■ ■ ■ □
-20 °C	■ ■ □ ■
-30 °C	■ ■ □ □
-40 °C	■ □ ■ ■
-50 °C	■ □ □ ■
-100 °C	■ □ □ □
-150 °C	■ □ □ □
-200 °C	■ □ □ □
+50 °C	□ ■ ■ ■
+100 °C	□ ■ □ ■
+150 °C	□ ■ □ □
+200 °C	□ ■ □ □
+250 °C	□ □ ■ ■
+500 °C	□ □ □ ■
SW 2	
Output	6 7
0...10 V	■ □
0...20 mA	□ □
4...20 mA	□ ■
Filter	8
off	□
on	■

Switch position/setting options

SW 1	
Type	1 2 3
K	■ ■ ■
J	□ ■ ■
T	■ □ ■
E	□ □ ■
N	■ ■ □
R	□ ■ □
S	■ □ □
B	□ □ □
SW 2	
Span	1 2 3 4 5
100 °C	■ ■ ■ ■ ■
150 °C	■ ■ ■ ■ □
200 °C	■ ■ ■ □ □
250 °C	■ ■ □ □ □
300 °C	■ ■ □ □ □
350 °C	■ ■ □ □ □
400 °C	■ ■ □ □ □
450 °C	■ ■ □ □ □
500 °C	■ □ □ □ □
550 °C	■ □ □ □ □
600 °C	■ □ □ □ □
650 °C	■ □ □ □ □
700 °C	■ □ □ □ □
750 °C	■ □ □ □ □
800 °C	■ □ □ □ □
850 °C	■ □ □ □ □
900 °C	■ □ □ □ □
950 °C	■ □ □ □ □
1000 °C	■ □ □ □ □
1050 °C	■ □ □ □ □
1100 °C	■ □ □ □ □
1150 °C	■ □ □ □ □
1200 °C	■ □ □ □ □
1250 °C	■ □ □ □ □
1300 °C	■ □ □ □ □
1350 °C	■ □ □ □ □
1400 °C	■ □ □ □ □
1450 °C	■ □ □ □ □
1500 °C	■ □ □ □ □
1600 °C	■ □ □ □ □
1700 °C	■ □ □ □ □
1800 °C	■ □ □ □ □
SW 1	
Tmin	4 5 6 7
0 °C	■ ■ ■ ■
-10 °C	■ ■ ■ □
-20 °C	■ ■ □ ■
-30 °C	■ ■ □ □
-40 °C	■ □ ■ ■
-50 °C	■ □ □ ■
-100 °C	■ □ □ □
-150 °C	■ □ □ □
-200 °C	■ □ □ □
+50 °C	□ ■ ■ ■
+100 °C	□ ■ □ ■
+150 °C	□ ■ □ □
+200 °C	□ ■ □ □
+250 °C	□ □ ■ ■
+500 °C	□ □ □ ■
SW 2	
Output	6 7
0...10 V	■ □
0...20 mA	□ □
4...20 mA	□ ■
Filter	8
off	□
on	■

Accuracy

K	-200 °C ... -150 °C	± (5K + 0,1 % of set range)
	-150 °C ... 1200 °C	± (3K + 0,1 % of set range)
	1200 °C ... 1372 °C	± (4K + 0,1 % of set range)
J	-200 °C ... -150 °C	± (4K + 0,1 % of set range)
	-150 °C ... 1200 °C	± (3K + 0,1 % of set range)
T	-200 °C ... -150 °C	± (5K + 0,1 % of set range)
	-150 °C ... 400 °C	± (3K + 0,1 % of set range)
E	-200 °C ... -150 °C	± (4K + 0,1 % of set range)
	-150 °C ... 1000 °C	± (3K + 0,1 % of set range)
N	-200 °C ... -150 °C	± (6K + 0,1 % of set range)
	-150 °C ... 1300 °C	± (3K + 0,1 % of set range)
R	-50 °C ... 200 °C	± (10K + 0,1 % of set range)
	200 °C ... 1760 °C	± (6K + 0,1 % of set range)
S	-50 °C ... 200 °C	± (10K + 0,1 % of set range)
	200 °C ... 1760 °C	± (6K + 0,1 % of set range)
B	50 °C ... 250 °C	± (25K + 0,1 % of set range)
	250 °C ... 500 °C	± (10K + 0,1 % of set range)
	500 °C ... 1820 °C	± (6K + 0,1 % of set range)

Dimensions	
Clamping range (nominal / min. / max.)	mm²
Depth x width x height	mm
Note	

Screw connection	Tension clamp connection
2.5/0.5/2.5	1.5/0.5/2.5
112.4/12.5	112.4/12.5

Ordering data

	Screw connection
	Tension-clamp connection

Type	Qty.	Order No.
WTS4 THERMO	1	8432300000
WTZ4 THERMO	1	8432310000

Note	
-------------	--

Note	
-------------	--

Accessories

Note	
-------------	--

Note	Cross-connector for power supplies and markers – refer to Accessories
-------------	---

Signal converters

D

WAVEANALOG PRO Frequency

WAVEANALOG PRO Frequency delivers settings help, for any input and output values.

The input range is set using the DIP switches (a frequency generator is not required)

There are 2 different methods:

1. Lower measuring frequency = 0 Hz

- Choose operating mode “= ... fmax” S2.3 = 0 and S2.4 = 0
- Set the upper measuring frequency using DIP switches S1 and S2.1, S2.2 (see table)
- That’s all!

2. Lower measuring frequency ≠ 0 Hz

- First the lower measuring frequency must be saved. Select mode “save fmin”. S2.3 = 1 and S2.4 = 0. Set the frequency using DIP switches S1 and S2.1, S2.2 (see table) To save the frequency, briefly connect the module to the power supply.
- Select mode “fmin ... fmax” S2.3 = 0 and S2.4 = 1
- Set the upper measuring frequency using DIP switches S1 and S2.1, S2.2 (see table).
- That’s all!

Adjusting input range using frequency device to be measured:

- Select the switch setting for saving the frequency: S2.1 = 0, S2.2 = 1, S2.3 = 1 and S2.4 = 1
- Apply min. frequency to the module
- Connect the module to the power supply
- The LED lights up when the input frequency is being measured. If the LED goes off, the frequency has been saved and the module can be disconnected from the power supply again.
- Repeat with max. frequency: S2.1 = 1, S2.2 = 0, S2.3 = 1 and S2.4 = 1
- Select special range: S2.1 = 1, S2.2 = 1, S2.3 = 1 and S2.4 = 1

Connection configuration for the sensors

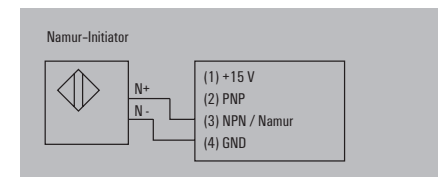
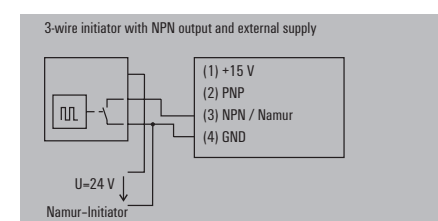
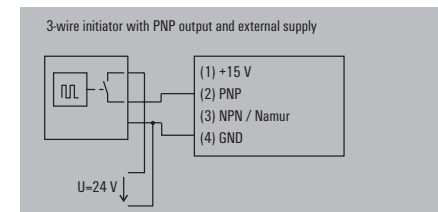
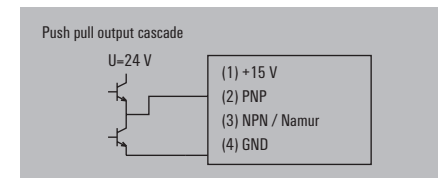
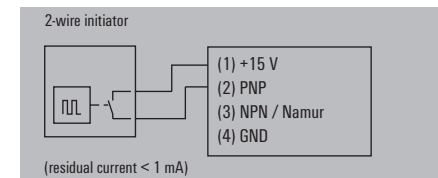
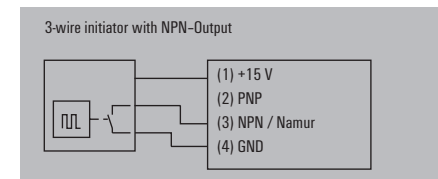
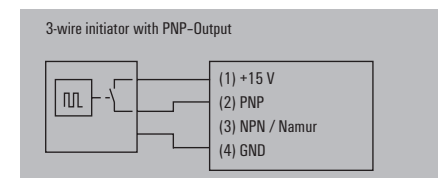

f/DC isolator/converter

- 3-way isolation
- Max. input frequency: 100 kHz
- Input and output ranges can be adjusted via DIP switches
- No calibration necessary
- Supplies the NAMUR sensor
- Programmable custom range
- Can be adjusted and set using the WAVETOOL software, download from www.weidmueller.com

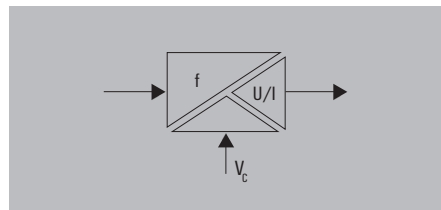

PRO Frequency

UL Class I, Div. 2

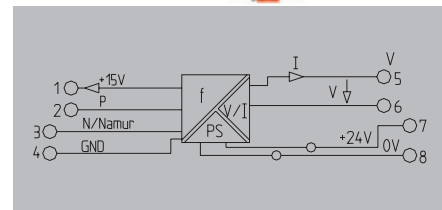

Technical data

Input	
Sensor	2-, 3-wire PNP/NPN, Namur initiator, push-pull step, Frequency
Rated input level	Threshold/hysteresis: Namur: approx. 1.7 mA/approx. 0.2 mA; NPN: approx. 6.5 V/approx. 0.2 V; PNP: approx. 6.7 V/approx. 0.5 V
Output	
Output voltage / Output current	0...5 V, 0...10 V, adjustable / 0...20 mA, 4...20 mA, adjustable
Load impedance, voltage/current	≥ 1 kΩ / ≤ 600 Ω
Offset current / Offset voltage	max. 100 μA / max. 0.05 V
Status indicator	Green LED
General data	
Configuration	DIP switch (measurement range 0...15900 Hz), Frequency generator (measurement range 0...100 kHz)
Supply voltage	24 V DC ± 25 %
Power consumption	Max. 1.6 W at I _{OUT} = 20 mA
Accuracy	< 0.2% of output range
Temperature coefficient	Max. 200 ppm/K of output range
Step response time	360 ms + 2 times the period time of input frequency
Ambient temperature	0 °C...55 °C
Approvals	CE; cULus; cULusEX; EAC
Insulation coordination	
Standards	DIN EN 50178, DIN EN 61000-4-2
EMC standards	EN 55011, EN 61000-6, EN 61326
Rated voltage	300 V
Impulse withstand voltage	6 kV
Insulation voltage	4 kV _{eff} / 5 s
Overvoltage category	III
Pollution degree	2
Clearance & creepage distances	≥ 5.5 mm

Dimensions	
Clamping range (nominal / min. / max.)	mm ²
Depth x width x height	mm

Ordering data

	Screw connection
	Tension-clamp connection

Type	Qty.	Order No.
------	------	-----------

Screw connection	Tension clamp connection
2.5/0.5/2.5	1.5/0.5/2.5
112.4/12.5	112.4/12.5

WAS4 PRO Freq	1	8581180000
WAZ4 PRO Freq	1	8581190000

Accessories

Note	Cross-connector for power supplies and markers – refer to Accessories
------	---

Selecting the operating mode	
Operating mode	Switch 2
0 ... fmax	3 4
fmin ... fmax	□ ■
saving of fmin	■ □

f = (A+B) x C

Selecting the frequency				Selecting the frequency															
A	Switch 1			B	Switch 1														
0	1	2	3	4	5	6	7												
1	□	□	□	□	0.1	□	□												
2	□	□	□	■	0.2	□	□												
3	□	□	■	□	0.3	□	□												
4	□	■	□	□	0.4	□	□												
5	□	■	■	□	0.5	□	□												
6	□	■	■	■	0.6	□	□												
7	■	□	□	□	0.7	□	□												
8	■	□	□	■	0.8	■	□												
9	■	□	□	■	0.9	■	□												
10	■	□	■	□	<table border="1"> <tr> <th colspan="2">Selecting the frequency</th> </tr> <tr> <th>C</th> <th>Switch 2</th> </tr> <tr> <td>x1</td> <td>1 2</td> </tr> <tr> <td>x10</td> <td>□ ■</td> </tr> <tr> <td>x100</td> <td>■ □</td> </tr> <tr> <td>x1000</td> <td>■ ■</td> </tr> </table>			Selecting the frequency		C	Switch 2	x1	1 2	x10	□ ■	x100	■ □	x1000	■ ■
Selecting the frequency																			
C	Switch 2																		
x1	1 2																		
x10	□ ■																		
x100	■ □																		
x1000	■ ■																		
11	■	□	■	■															
12	■	■	□	□															
13	■	■	□	■															
14	■	■	■	□															
15	■	■	■	■															

Selecting the output			
Output	5	6	7
0...10 V	■	□	■
0...20 mA	□	□	□
4...20 mA	□	■	□
0...5 V	■	■	■

Special range (frequency generator is required)			
Function	1	2	3
save min. frequency	□	■	■
save max. frequency	■	□	■
select special range	■	■	■

- = on
- = off

Application

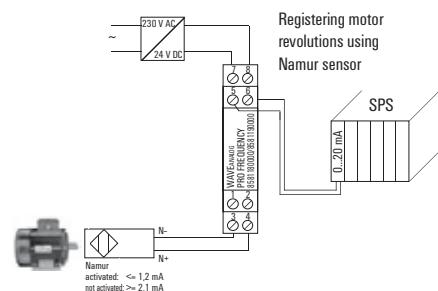

D

WAVESERIES - Current measuring transducer

Analogue output

- Monitors AC currents
- Input and output are electrically isolated
- Input and output ranges adjustable via DIP switch

1/5/10 A AC



1/5/10 A AC 4...20 mA

Loop-powered

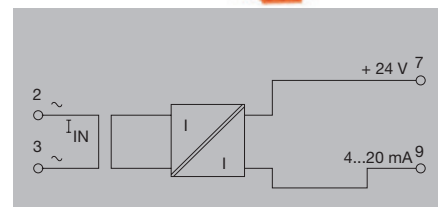
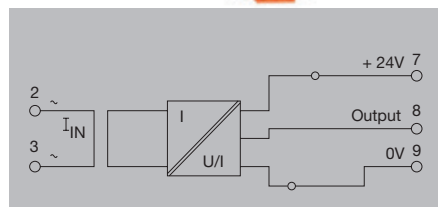
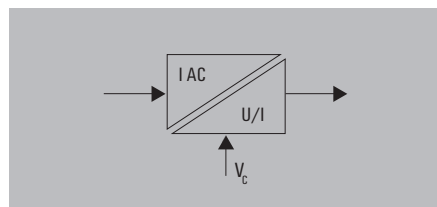

Technical data

Input	1/5/10 A AC	1/5/10 A AC 4...20 mA
Input current	0...1 A AC/ 0...5 A AC/ 0...10 A AC	0...1 A AC/ 0...5 A AC/ 0...10 A AC
Input frequency	50...60 Hz	50...60 Hz
Max. current	100 A for 1s	100 A for 1s
Voltage of measuring circuit	250 V AC	250 V AC
Sensor	Transforming (internally)	Transforming (internally)
Output		
Output current / Output voltage	0...20 mA / 0...10 V	4...20 mA (current loop) /
Offset current	max. 100 µA	max. 100 µA
Output signal limit	Approx. 13 V or 24 mA	Approx. 24 mA
Load impedance, voltage/current	≥ 1 kΩ / ≤ 600 Ω	/ ≤ 600 Ω
Step response time	typ. 700 ms	typ. 700 ms
Accuracy	0.5 % FSR	0.5 % FSR
Temperature coefficient	≤ 200 ppm/K	≤ 200 ppm/K
Status indicator	LED ON: OK; FLASHING: signal out of range; LED OFF: Error	LED ON: OK; FLASHING: signal out of range; LED OFF: Error
General data		
Configuration	DIP switch	DIP switch
Supply voltage	24 V DC ± 10 %	13...30 V DC, via output current loop
Current consumption	40 mA @ I _{OUT} = 20 mA	
Current-carrying capacity of cross-connect.	≤ 2 A	
Ambient temperature / Storage temperature	/ 0 °C...50 °C / -20 °C...70 °C	/ 0 °C...50 °C / -20 °C...70 °C
Default setting	0...5 A AC, 4...20 mA	0...5 A AC, 4...20 mA
Approvals	CE; cULus; EAC	CE; cULus; EAC
Insulation coordination		
Standards	DIN EN 50178 (secure separation)	DIN EN 50178 (secure separation)
EMC standards	EN 55011, EN 61000-6	EN 55011, EN 61000-6
Rated voltage	300 V	300 V
Impulse withstand voltage	6 kV	6 kV
Pollution degree	2	2
Overvoltage category	III	III
Clearance & creepage distances	≥ 5.5 mm	≥ 5.5 mm
Insulation voltage	4 kV _{eff} / 5 s	4 kV _{eff} / 5 s
Dimensions		
Clamping range (nominal / min. / max.)	mm ²	mm ²
Depth x width x height	mm	mm
Note		

Dimensions	Screw connection	Tension clamp connection
Clamping range (nominal / min. / max.)	2.5/0.5/2.5	1.5/0.5/2.5
Depth x width x height	92.4/22.5	92.4/22.5

Dimensions	Screw connection	Tension clamp connection
Clamping range (nominal / min. / max.)	2.5/0.5/2.5	1.5/0.5/2.5
Depth x width x height	92.4/22.5	92.4/22.5

Dimensions	Screw connection	Tension clamp connection
Clamping range (nominal / min. / max.)	2.5/0.5/2.5	1.5/0.5/2.5
Depth x width x height	112.4/22.5	112.4/22.5

Ordering data

	Type	Qty.	Order No.
Screw connection	WAS1 CMA 1/5/10A ac	1	8523400000
Tension-clamp connection	WAZ1 CMA 1/5/10A ac	1	8523410000

	Type	Qty.	Order No.
Screw connection	WAS1 CMA LP 1/5/10A ac	1	8528650000
Tension-clamp connection	WAZ1 CMA LP 1/5/10A ac	1	8528660000

Accessories

Note	
	Cross-connectors for power supplies and markers - refer to Accessories

WAVESERIES - Current measuring transducer

Signal converters

D

Analogue output

- Monitors AC currents
- Input and output are electrically isolated
- Input and output ranges adjustable via DIP switch
- No calibration required
- ATEX II 3 G nL IIC T4
- UL Class I, Div.2

1/5/10 A AC 4...20 mA

Loop-powered

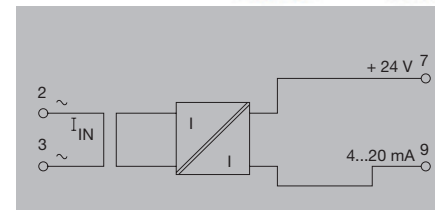
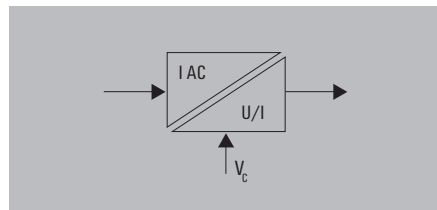

Technical data

Input	
Input current	0...1 A AC/0...5 A AC/0...10 A AC
Input frequency	50...60 Hz
Max. current	100 A for 1s
Voltage of measuring circuit	250 V AC
Sensor	Transforming (internally)

Output current / Output voltage	4...20 mA (current loop) /
Offset current	max. 100 µA
Output signal limit	Approx. 24 mA
Load impedance, voltage/current	/ ≤ 600 Ω
Step response time	typ. 700 ms
Accuracy	0.5 % FSR
Temperature coefficient	≤ 200 ppm/K
Status indicator	LED ON: OK; FLASHING: signal out of range; LED OFF: Error

Output	
Output current / Output voltage	4...20 mA (current loop) /
Offset current	max. 100 µA
Output signal limit	Approx. 24 mA
Load impedance, voltage/current	/ ≤ 600 Ω
Step response time	typ. 700 ms
Accuracy	0.5 % FSR
Temperature coefficient	≤ 200 ppm/K
Status indicator	LED ON: OK; FLASHING: signal out of range; LED OFF: Error

DIP switch	
Supply voltage	13...30 V DC, via output current loop
Current consumption	
Current-carrying capacity of cross-connect.	
Ambient temperature / Storage temperature	/ 0 °C...50 °C / -20 °C...70 °C
Default setting	0...5 A AC, 4...20 mA
Approvals	CE; cULusEX; DEMKOATEX; EAC

General data	
Configuration	DIP switch
Supply voltage	13...30 V DC, via output current loop
Current consumption	
Current-carrying capacity of cross-connect.	
Ambient temperature / Storage temperature	/ 0 °C...50 °C / -20 °C...70 °C
Default setting	0...5 A AC, 4...20 mA
Approvals	CE; cULusEX; DEMKOATEX; EAC

DIP switch	
Supply voltage	13...30 V DC, via output current loop
Current consumption	
Current-carrying capacity of cross-connect.	
Ambient temperature / Storage temperature	/ 0 °C...50 °C / -20 °C...70 °C
Default setting	0...5 A AC, 4...20 mA
Approvals	CE; cULusEX; DEMKOATEX; EAC

Insulation coordination	
Standards	DIN EN 50178 (secure separation)
EMC standards	EN 55011, EN 61000-6
Rated voltage	300 V
Impulse withstand voltage	6 kV
Pollution degree	2
Overvoltage category	III
Clearance & creepage distances	≥ 5.5 mm
Insulation voltage	4 kV _{eff} / 5 s

DIP switch	
Supply voltage	13...30 V DC, via output current loop
Current consumption	
Current-carrying capacity of cross-connect.	
Ambient temperature / Storage temperature	/ 0 °C...50 °C / -20 °C...70 °C
Default setting	0...5 A AC, 4...20 mA
Approvals	CE; cULusEX; DEMKOATEX; EAC

Dimensions	
Clamping range (nominal / min. / max.)	mm ²
Depth x width x height	mm

Screw connection	
Clamping range (nominal / min. / max.)	mm ²
Depth x width x height	mm

Note

Ordering data

Screw connection	
Tension-clamp connection	

Type	Qty.	Order No.
WAS1 CMA LP 1/5/10A EX	1	8975590000

Note

Accessories

Note

Cross-connectors for power supplies and markers - refer to Accessories

WAVESERIES - Voltage measuring transducer

Analogue output

- 3-way isolation
- Max. measuring voltage 450 V AC_{eff}
- Output range selected via DIP switch
- No calibration necessary

VMA V AC

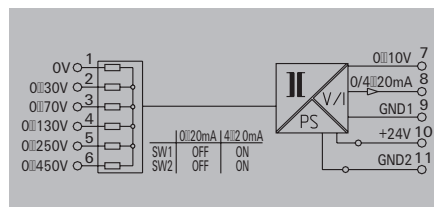
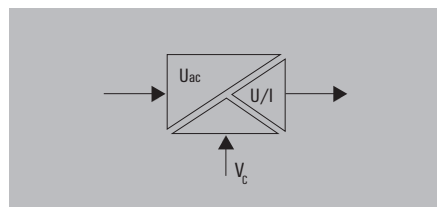

Technical data

Input	
Input voltage	0...30 / 0...70 / 0...130 / 0...250 / 0...450 V AC
Input frequency	40...400 Hz sinus
Max. voltage	45 / 100 / 180 / 270 / 475 V AC (briefly)
Output	
Output voltage / Output current	0...10 V / 0...20 mA
Offset voltage / Offset current	max. 0.02 V / max. 40 µA
Load impedance, voltage/current	≥ 1 kΩ / ≤ 600 Ω
Accuracy	1,3 % (40...60 Hz) typ. 1 %; 2 % (70...400 Hz) typ. 1,5 %
Temperature coefficient	≤ 250 ppm/K
Step response time	< 300 ms
Status indicator	Green LED
General data	
Configuration	DIP switch
Supply voltage	24 V DC ± 25 %
Current consumption	40...30...24 mA @ I _{OUT} = 20 mA
Current-carrying capacity of cross-connect.	≤ 2 A
Default setting	0...10 V / 0...20 mA
Ambient temperature / Storage temperature	/ 0 °C...50 °C / -20 °C...70 °C
Approvals	CE; cULus; EAC
Insulation coordination	
Standards	DIN EN 50178
EMC standards	EN 61000-2-6, EN 61000-6, EN 61326
Rated voltage	supply/output: 300 V; input/output, supply/output: 600 V
Impulse withstand voltage	Supply/output: 4 kV; input/output, supply/input: 6 kV
Insulation voltage	4 kV _{eff} / 5 s
Overvoltage category	III
Pollution degree	2
Clearance & creepage distances	Supply/output: 3 mm; input/output, supply/output: 5.5 mm

Application

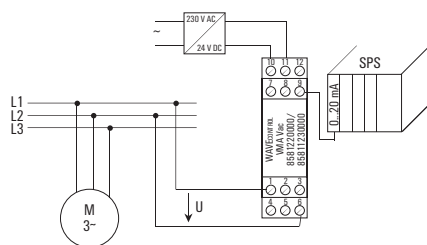

Dimensions		Screw connection	Tension clamp connection
Clamping range (nominal / min. / max.)	mm ²	2.5/0.5/2.5	1.5/0.5/2.5
Depth x width x height	mm	112.4/22.5	112.4/22.5
Note			

Ordering data

	Type	Qty.	Order No.
Screw connection	WAS2 VMA V ac	1	8581220000
Tension-clamp connection	WAZ2 VMA V ac	1	8581230000

Note

Accessories

Note Cross-connector for power supplies and markers – refer to Accessories

Signal converters

D

Isolating converters for serial interfaces

Isolating converters for serial interfaces RS232/ RS485/422 or TTY

Serial interface are used for exchanging data between data processing systems, controllers and peripherals. The WDS2 interface isolating converter is particularly well suited for harsh conditions located near to the process. Versions are available for a variety of industrial applications:

- RS232/RS422 or RS485
- RS232/TTY

The thin (22.5 mm wide) rail-mounted modules come with a 9-pole SUB-D connector for the RS232 connection and a shield connection for the RS485/422 or TTY signal line. In order to ensure high transmission security, the serial interface isolating converters are equipped with high-quality 4-kV 3-way electrical isolation.

- **Easy to service:** the electronic components can be removed from the housing/base without using any tools. The terminating resistor can be selected with DIP switch.
- **High data transmission speeds** up to 115 kBit/s and freely adjustable
- **Secure connection:** 9-pole Sub-D connector for the RS232 interface.
For the serial RS485/422 and TTY connection, the user can connect the shield using the LLBU or the EMC Set (1067470000).



Isolating converter for serial interfaces

Signal converters

D

RS232/RS485/422

- 3-way isolation
- RS232 connection via SUB-D 9
- RS485/422, shield connection via KLBUE
- Switchable DTE or DCE assignment
- Bi-directional communication

RS232/RS485/422

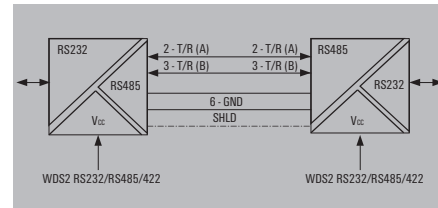
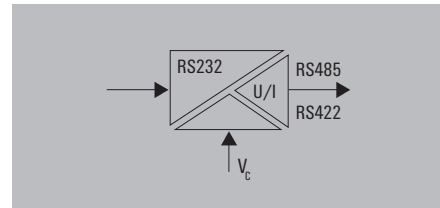

Technical data

RS232	RS485/422
Connection type / Input current	SUB-D9 (male plug) /
Assignment	DTE/DCE switchable with DIP switch
Terminating resistors	Pull-down/pull-up via DIP switch
Type of connection	Screw connection
Bit distortion	< 5 %
Bit delay	≤ 3 μs
Control of data direction	Automatic or via RS232 RTS/CTS
Shield connection	KLBÜ 4-6/Z1
Status indicator	LED green: supply voltage, TxD, RxD
Transmission rate	2.4, 4.8, 9.6, 19.2, 57.6, 115.2 kBaud, 8 bit or 8 bit + parity bit
Transmission channels	Half-duplex (RS485 2-wire) Full-duplex (RS485 4-wire and RS422)
Transmission distance	Max. 1200 m twisted pair
General data	
Configuration	DIP switch
Supply voltage	24 V DC ± 20 %
Power consumption	ca. 1.5 W
Ambient temperature	0 °C...55 °C
Approvals	CE; cULus; EAC; GL
Insulation coordination	
Standards	DIN EN 50178, DIN EN 61000-4-2
EMC standards	EN 55011, EN 61000-6-2, EN 61000-6-4
Rated voltage	between adjacent electric circuits: 300 V between electric circuits and PE: 150 V
Impulse withstand voltage	4 kV
Pollution degree	2
Overvoltage category	III
Clearance & creepage distances	Between neighbouring circuits: 3 mm Between the circuits and PE: 1.5 mm
Insulation voltage	2 kV DC / 1 min.

Dimensions

Clamping range (nominal / min. / max.)
Depth x width x height

Note

Screw connection

2.5 / 0.5 / 2.5
/ 22.5 / 112.4

Ordering data

Type	Qty.	Order No.
WDS2 RS232/RS485/422	1	8615700000

Note

Accessories

Note

Cross-connector for power supplies and markers – refer to Accessories

Isolating converter for serial interfaces

RS232/TTY

- 3-way isolation
- RS232 connection via SUB-D 9
- TTY shield connection via KLBU retaining clip
- Switchable DTE or DCE assignment
- Bi-directional communication

RS232/TTY

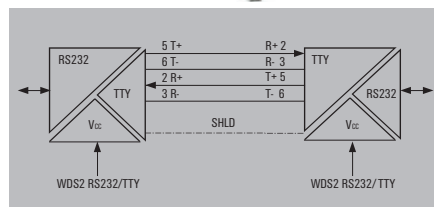
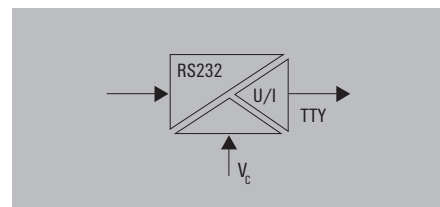

Technical data

RS232	RS232/TTY
Connection type / Input current	SUB-D9 (male plug) /
Assignment	DTE/DCE switchable with DIP switch
TTY	
Type of connection	Screw connection
Bit distortion	< 1.5%
Bit delay	≤ 3 μs
Load	≤ 500 Ω
Shield connection	KLBU 4-6/Z1
Status indicator	LED green: supply voltage, TxD, RxD
Transmission rate	19.2 kBit/s
Transmission channels	Full-duplex
Transmission distance	Max. 1000 m twisted pair
General data	
Configuration	DIP switch
Supply voltage	24 V DC ± 20 %
Power consumption	ca. 0.8 W
Ambient temperature	0 °C...55 °C
Storage temperature	-20 °C...85 °C
Approvals	CE, cULus, EAC, GL
Insulation coordination	
Standards	DIN EN 50178, DIN EN 61000-4-2
EMC standards	EN 55011, EN 61000-6-2, EN 61000-6-4
Rated voltage	between adjacent electric circuits: 300 V between electric circuits and PE: 150 V
Impulse withstand voltage	4 kV
Pollution degree	2
Overvoltage category	III
Clearance & creepage distances	Between neighbouring circuits: 3 mm Between the circuits and PE: 1.5 mm
Insulation voltage	2 kV DC / 1 min.

Dimensions	Screw connection
Clamping range (nominal / min. / max.)	2.5 / 0.5 / 2.5
Depth x width x height	/ 22.5 / 112.4
Note	

Ordering data

Type	Qty.	Order No.
WDS2 RS232/TTY	1	8615690000

Screw connection

Note	
------	--

Accessories

Note	Cross-connector for power supplies and markers – refer to Accessories
------	---

Trip amplifier for monitoring AC/DC circuits

Trip amplifier for monitoring AC/DC circuits	Trip amplifier for monitoring AC/DC circuits - Overview	E.2
	WAVESERIES - Limit value monitoring	E.4
	PLUGCONTROL - Current monitoring	E.6
	WAVESERIES - Voltage monitoring	E.8

Trip amplifier for monitoring AC/DC circuits

Monitoring AC/DC currents and voltages within single-phase and three-phase power networks.

Some WAVESERIES products provide the function of monitoring voltage and current. Typical uses include low voltage distribution applications. This includes the monitoring of phase voltages and current while controlling actuators. Another application is in monitoring dropouts of a power supply, or accumulators and feed-in systems within industrial production lines. There are many applications for threshold monitoring (trip amplifier) products in process automation. Typically they are used to generate alarms when „out-of-limits“ signals are detected with fill levels, flow quantities or temperature signals.

The PLUGCONTROL series of current monitoring products monitor DC current up to 10 amps. They can be used in applications to monitor the functioning of valves, servo-controls and DC motors. The pluggable detector uses the same socket (base) as Weidmüller PLUGSERIES relays and optos socket base so it uses the same quick-and-easy to use pluggable ZQV cross-connections for saving wiring time. A lever is provided to quickly release or instal the detector.

Features

WAVECONTROL:

- Threshold monitoring of analogue standard signals
- Measuring AC currents ranging from 1 to 30 A
- Monitoring DC and AC voltages up to 400 V
- Fully adjustable switching thresholds
- Relay outputs for monitoring threshold
- Versatile pluggable connection method – screw or spring

PLUGCONTROL:

- Monitoring for DC currents ranging from 0.5 to 10 A
- Very small, pluggable monitoring unit
- Reed relay contact for monitoring and measuring current
- Install on standard base
- Quick initial commissioning – with replaceable electronics
- Minimal wiring effort – with pluggable ZQV 2,5N cross-connector

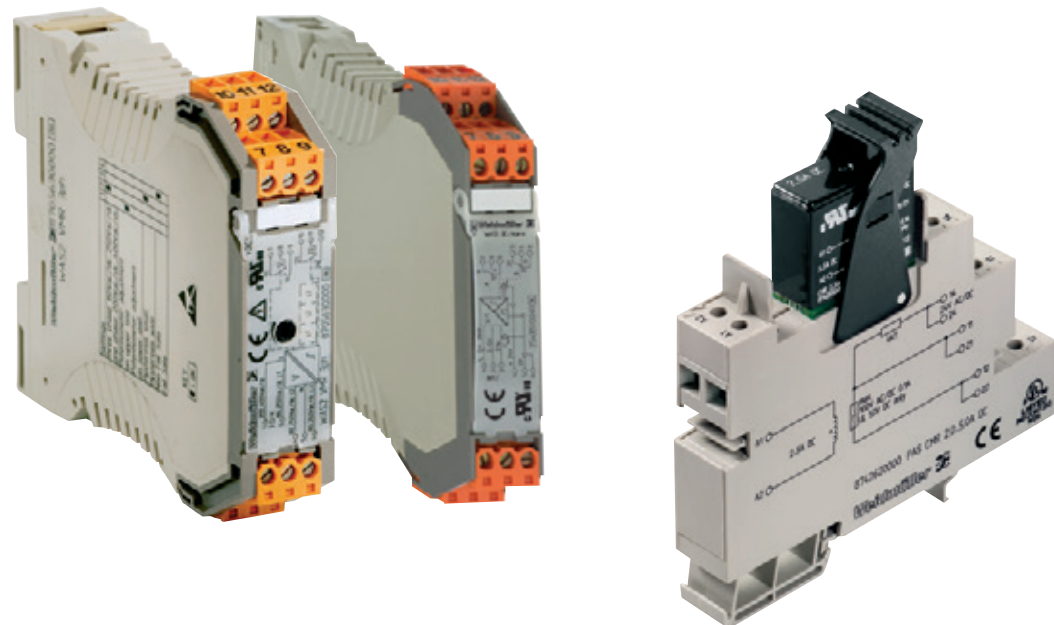

Trip amplifier for monitoring AC/DC circuits - Overview

Trip amplifier for monitoring
AC/DC circuits

E



**Threshold monitoring of analogue
standard signals**



Current monitoring



Voltage monitoring

WAVESERIES - Limit value monitoring

Relay output

- 3-way isolation
- Low trip / high trip
- FAILSAFE / NON-FAILSAFE
- 2 relay outputs 250 V AC / 3 A

DC/Alarm

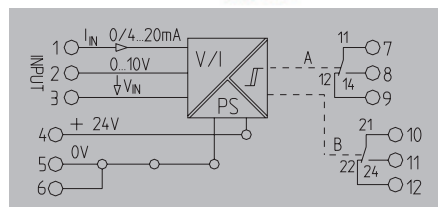
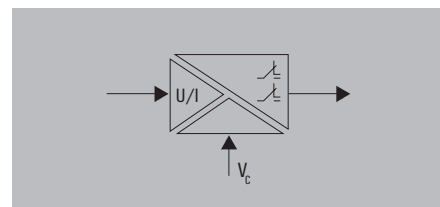

Technical data

Input

Input voltage	0...10 V
Input current	0...20 mA
Input resistance, voltage/current	≥ 100 kΩ / ≤ 110 Ω

Output

Contact assembly	2 CD contacts
Contact material	AgNi 90/10
Switching thresholds	1...90 % (independently for channel 1 and channel 2)
Hysteresis	1...10 % (independent for channel 1 and channel 2)
Max. switching voltage, AC	250 V
Continuous current	3 A
Function	Open-circuit/closed-circuit principle
Temperature coefficient	≤ 500 ppm/K
Status indicator	LED green ON: OK, LED red ON: alarm (per channel)

General data

Configuration	DIP switch, Potentiometer
Supply voltage	24 V DC ± 25 %
Power consumption	Typically 1 W both relays picked up
Current-carrying capacity of cross-connect.	≤ 2 A
Ambient temperature	0 °C...55 °C
Default setting	Channel A/B: low trip and FAILSAFE
Approvals	CE: cULus; EAC

Insulation coordination

Standards	DIN EN 50178
EMC standards	EN 61000-4-2, -3, -4, -5, -6
Rated voltage	300 V
Impulse withstand voltage	4 kV
Pollution degree	2
Overvoltage category	III
Clearance & creepage distances	≥ 3 mm
Insulation voltage	2 kV _{eff} / 5 s

Dimensions

Clamping range (nominal / min. / max.)	mm ²
Length x width x height	mm

Note

Screw connection Tension clamp connection

Clamping range (nominal / min. / max.)	mm ²
Length x width x height	mm

Ordering data

	Screw connection
	Tension-clamp connection

Type	Qty.	Order No.
WAS5 DC/Alarm	1	8543820000
WAZ5 DC/Alarm	1	8543880000

Note

Accessories

Note

Cross-connector for power supplies and markers – refer to Accessories

Switch position/setting options

function	SW 1			
	1	2	3	4
Channel A High Trip	■			
Channel A Low Trip	□			
Channel B High Trip		■		
Channel B Low Trip		□		
FAILSAFE, Channel 1 & 2			□	□
NON FAILSAFE, Chan. 1 & 2			■	■

■ = on
□ = off

NON FAILSAFE: The relay picks up when the alarm is triggered
FAILSAFE: The relay drops out when the alarm is triggered.

An alarm is also triggered in the FAILSAFE mode, if for example, the operating voltage to the modules fails

Low Trip: Alarm is triggered if the signal is under the threshold.

High Trip: Alarm is triggered if the signal is over the threshold.

Signal threshold: Adjustments of the signal threshold (1...90)% are made for channel 1 with the potentiometer P1, and separately for channel 2 via potentiometer P2.

Hysteresis: Adjustments of the hysteresis (1...10)% are made for channel 1 with the potentiometer P3, and separately for channel 2 via potentiometer P3.

WAVEANALOG DC/Alarm

- Alarm indication

Example 1

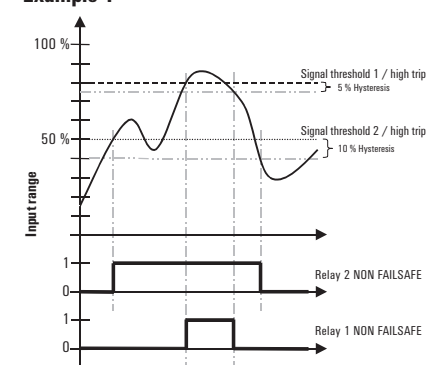

Example 2

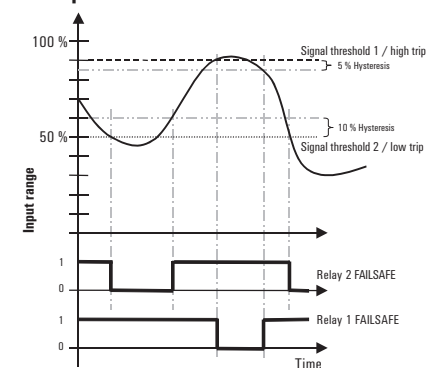

Trip amplifier for monitoring
AC/DC circuits

E

PLUGCONTROL - Current monitoring

Relay output

- Monitors currents up to 10 A DC
- Used with valves, servo-controls or DC motors
- Pull-up / pull-down resistor 4.7 kΩ

PAS CMR 0.5...2.5 A DC

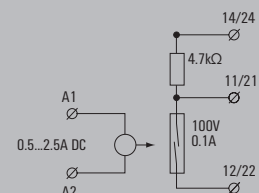

PAS CMR 2.0...5.0 A DC

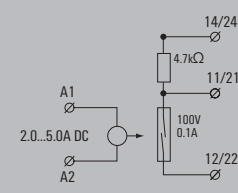

Technical data

Input	PAS CMR 0.5...2.5 A DC	PAS CMR 2.0...5.0 A DC
Input current	0.5...2.5 A DC	2...5.0 A DC
Max. current	7.5 A for 10 s	15 A for 10 s
Making current threshold	≤ 500 mA	≤ 2 A
Input resistance, current	< 50 mΩ	< 50 mΩ
Secure off	≤ 50 mA	≤ 300 mA
Pulse duration	min. 1 ms	min. 1 ms
Output		
Switching current	100 mA	100 mA
Switching voltage AC / Switching voltage DC	/ 1 V...100 V 1 V...100 V	/ 1 V...100 V 1 V...100 V
Max. switching frequency	15 Hz	15 Hz
Contact assembly	1 NO contact	1 NO contact
Contact material	RH/Rd (Reed contact)*	RH/Rd (Reed contact)*
General data		
Configuration	none	none
Ambient temperature	0 °C...55 °C	0 °C...55 °C
Humidity	5-95% rel. humidity, T _o = 40°C, no condensation	5-95% rel. humidity, T _o = 40°C, no condensation
Approvals	CE; cULus; EAC	CE; cULus; EAC
Insulation coordination		
Standards	DIN EN 50178 (secure separation)	DIN EN 50178 (secure separation)
EMC standards	EN 55011, EN 61000-6-1, 2, 3, 4	EN 55011, EN 61000-6-1, 2, 3, 4
Rated voltage	300 V	300 V
Impulse withstand voltage	6 kV	6 kV
Insulation voltage	4 kV _{eff} / 1 min.	4 kV _{eff} / 1 min.
Overvoltage category	III	III
Pollution degree	2	2
Clearance & creepage distances	≥ 5 mm (grout encapsulated)	≥ 5 mm (grout encapsulated)

Dimensions
Clamping range (nominal / min. / max.)
Length x width x height
Note

Screw connection
1.5 / 2.5 / 2.5
92 / 15.3 /
* The peak current should be limited to 100 mA when under capacitive loads.

Screw connection
1.5 / 2.5 / 2.5
92 / 15.3 /
* The peak current should be limited to 100 mA when under capacitive loads.

Ordering data

Type	Qty.	Order No.	Type	Qty.	Order No.
PAS CMR 0.5...2.5 A DC	10	8742610000	PAS CMR 2.0...5.0 A DC	10	8742620000

Note

Note

Note

Accessories

Note
Cross-connectors and markers - refer to WAVESERIES accessories

Note
Cross-connectors and markers - refer to WAVESERIES accessories

Note
Cross-connectors and markers - refer to WAVESERIES accessories

PLUGCONTROL - Current monitoring

Relay output

- Monitors currents up to 10 A DC
- Used with valves, servo-controls or DC motors
- Pull-up / pull-down resistor 4.7 kΩ

PAS CMR 4.5...10 A DC

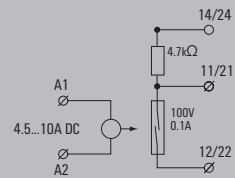

Technical data

Input	
Input current	4.5...10 A DC
Max. current	30 A for 10 s
Making current threshold	≤ 4.5 A
Input resistance, current	< 50 mΩ
Secure off	≤ 600 mA
Pulse duration	min. 1 ms
Output	
Switching current	100 mA
Switching voltage AC / Switching voltage DC	/ 1 V...100 V / 1 V...100 V
Max. switching frequency	15 Hz
Contact assembly	1 NO contact
Contact material	RH/Rd (Reed contact)*
General data	
Configuration	none
Ambient temperature	0 °C...55 °C
Humidity	5-95% rel. humidity, T _s = 40°C, no condensation
Approvals	CE; cULus; EAC
Insulation coordination	
Standards	DIN EN 50178 (secure separation)
EMC standards	EN 55011, EN 61000-6-1, 2, 3, 4
Rated voltage	300 V
Impulse withstand voltage	6 kV
Insulation voltage	4 kV _{eff} / 1 min.
Overvoltage category	III
Pollution degree	2
Clearance & creepage distances	≥ 5 mm (grout encapsulated)

Dimensions	Screw connection
Clamping range (nominal / min. / max.)	1.5 / 2.5 / 2.5
Length x width x height	92 / 15.3 / 95

Note * The peak current should be limited to 100 mA when under capacitive loads.

Ordering data

Type	Qty.	Order No.
PAS CMR 4.5...10 A DC	10	8742630000

Note

Accessories

Note Cross-connectors and markers - refer to WAVESERIES accessories

Trip amplifier for monitoring AC/DC circuits

E

WAVESERIES - Voltage monitoring

Relay output

- 3-way isolation
- Monitoring of single-phase systems up to 260 V AC/DC
- 4 input ranges per DIP switch can be selected
- 1 relay module with CO contact
- Switchable hysteresis
- Switch adjusted via potentiometer
- Reset input

VMR V AC / DC

Single-phase

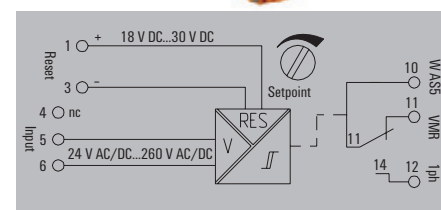
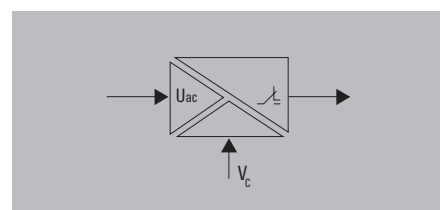

Technical data

Input	Output
Input voltage	24...70 / 70...140 / 140...210 / 210...260 V AC / DC
Input frequency	50...60 Hz
Max. voltage	260 V AC / DC
Output	
Max. switching voltage, AC	250 V
Switching current	8 A
Continuous current	3 A
Hysteresis	24...70 V AC, small = 5 V / large = 10 V, 70-260 VAC, small = 8 V / large = 16
Temperature coefficient	≤ 250 ppm/K
Step response time	< 300 ms
Repeat accuracy	< 0.3 % of set range
Status indicator	LED green = OK / LED yellow/red = alarm status
General data	
Supply voltage	from the measuring circuit
Reset input voltage, min./max.	18 V DC / 30 V DC
Pulse duration	≥ 700 ms
Configuration	DIP switch, Potentiometer, Alarm status reset via reset input or button
Default setting	DIP switches: ON = 1,2,5,8 / OFF = 3,4,6,7
Ambient temperature	-10 °C...55 °C
Storage temperature	-20 °C...70 °C
Approvals	CE; cULus; EAC
Insulation coordination	
Standards	DIN EN 50178
EMC standards	EN 55011, EN 61000-6, EN 61326
Rated voltage	input/output, input/reset input, reset input/output: 300 V
Impulse withstand voltage	Input/output, input/reset input, reset input/output: 4 kV
Insulation voltage	2 kV _{eff}
Overvoltage category	III
Pollution degree	2
Clearance & creepage distances	≥ 3 mm
Dimensions	
Clamping range (nominal / min. / max.)	2.5 / 0.5 / 2.5
Length x width x height	96.5 / 17.5 /
Note	

Ordering data

Type	Qty.	Order No.
WASS VMR 1ph	1	8705640000

Note

Accessories

Note	Markers - refer to Accessories.
------	---------------------------------

Table of setting options

Input	1	2	3	4	5	6	7	8
24 V AC/DC...70 V AC/DC	<input checked="" type="checkbox"/>	<input type="checkbox"/>	<input type="checkbox"/>	<input type="checkbox"/>	<input type="checkbox"/>	<input type="checkbox"/>	<input type="checkbox"/>	<input type="checkbox"/>
70 V AC/DC...140 V AC/DC	<input type="checkbox"/>	<input type="checkbox"/>	<input type="checkbox"/>	<input type="checkbox"/>	<input type="checkbox"/>	<input checked="" type="checkbox"/>	<input type="checkbox"/>	<input type="checkbox"/>
140 V AC/DC...210 V AC/DC	<input type="checkbox"/>	<input type="checkbox"/>	<input type="checkbox"/>	<input checked="" type="checkbox"/>	<input type="checkbox"/>	<input type="checkbox"/>	<input type="checkbox"/>	<input type="checkbox"/>
210 V AC/DC...260 V AC/DC	<input type="checkbox"/>	<input checked="" type="checkbox"/>	<input type="checkbox"/>	<input type="checkbox"/>	<input type="checkbox"/>	<input type="checkbox"/>	<input type="checkbox"/>	<input type="checkbox"/>
Trip								
High Trip	<input checked="" type="checkbox"/>	<input type="checkbox"/>	<input type="checkbox"/>	<input type="checkbox"/>	<input type="checkbox"/>	<input type="checkbox"/>	<input type="checkbox"/>	<input type="checkbox"/>
Low Trip	<input type="checkbox"/>	<input checked="" type="checkbox"/>	<input type="checkbox"/>	<input type="checkbox"/>	<input type="checkbox"/>	<input type="checkbox"/>	<input type="checkbox"/>	<input type="checkbox"/>
Memory								
Memory on	<input type="checkbox"/>	<input checked="" type="checkbox"/>	<input type="checkbox"/>	<input type="checkbox"/>	<input type="checkbox"/>	<input type="checkbox"/>	<input type="checkbox"/>	<input type="checkbox"/>
Memory out	<input checked="" type="checkbox"/>	<input type="checkbox"/>	<input type="checkbox"/>	<input type="checkbox"/>	<input type="checkbox"/>	<input type="checkbox"/>	<input type="checkbox"/>	<input type="checkbox"/>
Hysteresis								
Hysteresis small	<input type="checkbox"/>	<input checked="" type="checkbox"/>	<input type="checkbox"/>	<input type="checkbox"/>	<input type="checkbox"/>	<input type="checkbox"/>	<input type="checkbox"/>	<input type="checkbox"/>
Hysteresis large	<input checked="" type="checkbox"/>	<input type="checkbox"/>	<input type="checkbox"/>	<input type="checkbox"/>	<input type="checkbox"/>	<input type="checkbox"/>	<input type="checkbox"/>	<input type="checkbox"/>
Input voltage								
AC voltage	<input checked="" type="checkbox"/>	<input type="checkbox"/>	<input type="checkbox"/>	<input type="checkbox"/>	<input type="checkbox"/>	<input type="checkbox"/>	<input type="checkbox"/>	<input type="checkbox"/>
DC voltage	<input type="checkbox"/>	<input checked="" type="checkbox"/>	<input type="checkbox"/>	<input type="checkbox"/>	<input type="checkbox"/>	<input type="checkbox"/>	<input type="checkbox"/>	<input type="checkbox"/>

= on
 = out

Status indicator

- Set value not exceeded.
- ⊗ Alarm status.
- ⊗ Alarm status can be reset because set value has been exceeded.

Abb.1: Overvoltage monitoring
Alarm set to "high trip"
(Set permanently to closed-circuit principle.)



Abb.2: Undervoltage monitoring
Alarm set to "low trip"
(Set permanently to closed-circuit principle.)



Relay output

- 2-way isolation
- Monitoring of 1- and 3-phase systems from 80 to 400 V AC/DC
- Adjustable by DIP switches
- Monitoring of low and surge voltages
- Detects loss of phase
- 2 relay modules with CO contact

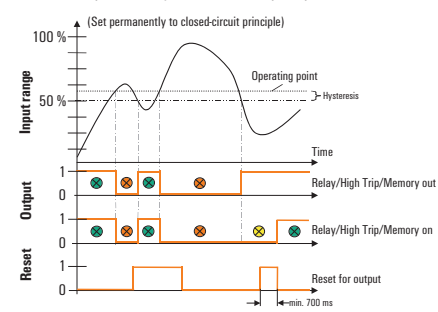
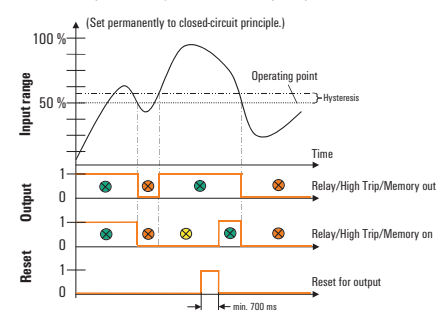
VMR V AC

Three-phase

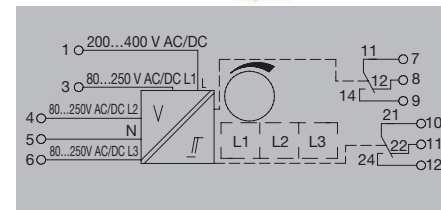
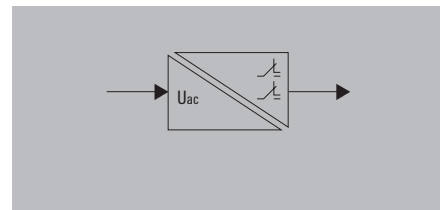

Technical data

Input

Input voltage
Input current

Output

Contact assembly
Max. switching voltage, AC
Continuous current
Hysteresis
Temperature coefficient
Step response time
Repeat accuracy
Status indicator
Green LED

General data

Configuration

Supply voltage
Default setting
Ambient temperature
Approvals

Insulation coordination

Standards
EMC standards
Rated voltage
Impulse withstand voltage
Insulation voltage
Overvoltage category
Pollution degree
Clearance & creepage distances

200...400 V AC/DC 1~, 80...250 V AC/DC 3~
< 10 mA DC, 15 mA AC

2 CO contacts
250 V
3 A
5% of final value
≤ 300 ppm/K
< 300 ms
< 0.3 % of set range
Green LED

DIP switch, Potentiometer, Alarm status reset via reset input or button

from the measuring circuit
DIP switches: ON = 1,2,4 / OFF = 3
0 °C...50 °C
CE; cULus; EAC

DIN EN 50178
EN 55011, EN 61000-6, EN 61326
600 V
6 kV
4 kV_{eff} / 1 min.
III
2
Output circuit: 1.8 mm; input circuit, output circuit 1/output circuit 2: 3 mm; input/output: 5.5 mm

Dimensions

Clamping range (nominal / min. / max.)
Length x width x height

Note

Screw connection

2.5 / 0.5 / 2.5
96.5 / 22.5 /

Ordering data

Screw connection

Type	Qty.	Order No.
WAS2 VMR 3ph	1	8705630000

Note

Accessories

Note

Markers - refer to Accessories.

Table of setting options

Input	1	2	3	4
3 phases 80 V AC/DC...250 V AC/DC		■		
1 phase 200 V AC/DC...400 V AC/DC			□	
Limit value				
Setting to upper switching point		■		
Setting to lower switching point			□	
Hysteresis				
Hysteresis, small			■	
Hysteresis, large				□
Fault tolerance				
Operating current method				■
Closed-circuit current method				□

■ = on
□ = off

Status indicator

● Voltage is in set range

Fig. 1: Overvoltage and undervoltage monitoring, example of setting

- 3-phase monitoring
- Setting limit value to upper operating point:
230 V Hysteresis 5% = -12.5 V
- Lower operating point 10% less 230 V - 25 V = 205 V
Hysteresis 5% = + 12.5 V
- The device operates with the operating current principle.
- All 3 phases monitored in parallel

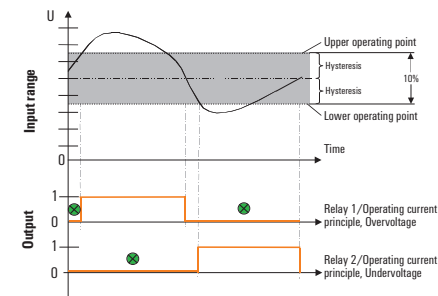
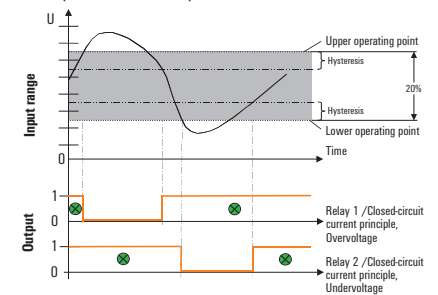

Fig. 2: Overvoltage and undervoltage monitoring, example of setting

- 3-phase monitoring
- Setting limit value to lower operating point:
150 V Hysteresis 5% = +12.5 V
- Upper operating point 20% greater 150 V + 50 V = 200 V
Hysteresis 5% = -12.5 V
- The device operates with the closed-circuit current principle.
- All 3 phases monitored in parallel



Indicators and configurable displays

Indicators and configurable displays	Overview	F.2
	Process value displays with LED display	F.4
	Process value displays with LCD display	F.20

Indicators and configurable displays

In industrial and process automation, displays provide a visual rendering of data and an digital presentation of electrical and non-electrical measurements. They provide essential diagnostics, logging and operational guidance when operating machines and facilities.

Displays make dialogue-based operations possible. They show measurements, error messages and also allow processes to be monitored. Displays can also feature digital and analogue outputs, interference-suppression functions, or the ability to calculate certain process variables internally. This turns a simple display into a high-quality process interface capable of independently controlling sub-processes.



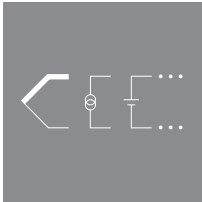

All-purpose

A fitting solution for any application – with a multitude of input ranges, external or input loop-powered supply, and analogue or digital outputs.

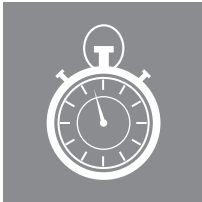

Security

No additional signal isolation is required since there is a high insulation voltage.



Saves time

Easy push-button configuration.



Protection

IP 65 protection allows for use in harsh industrial conditions.



	Flow rate or volume monitoring with LED display
	Process value indication with LCD display

Process value displays with LED display

Counters PTX800 SERIES

Panel-mounted totaliser/counter/rate monitors

The configurable monitors of the PTX800 SERIES are available in two designs:

- PTX800A for analogue (mA, Volts) inputs
- PTX800D with digital pulse inputs (NAMUR, NPN/PNP sensors, TTL, etc)

The eight-digit LED rate/total display can be changed via a button on the front of the unit. Both versions make use of output relays to close valves when the "total" setpoint is reached. They also have electrically-isolated analogue outputs for re-transmission.

The display can be globally scaled based on the flow quantity per second, minute, hour or day. The flow-quantity counter can be multiplied by factors of 0.001, 0.01, 0.1, 1, 10, 100 or 1000. This allows for best use of the display.

The PTX800A counter processes standardised analogue current and voltage signals. Linearisation and filtering functions are available for processing measurement signals. In addition, the counter has a 24 V DC power supply for loop-powered sensors.

The PTX800D can be connected on the input side to all standard initiators (NPN/PNP/Namur) and with other current/voltage transmitters. The monitor will accept any periodic signal type and can total the input pulses into a "total" display.

It can also calculate the resulting flow rate. External proximity switches can be supplied with 12 V DC directly from the PTX800D.

Typical application of PTX800

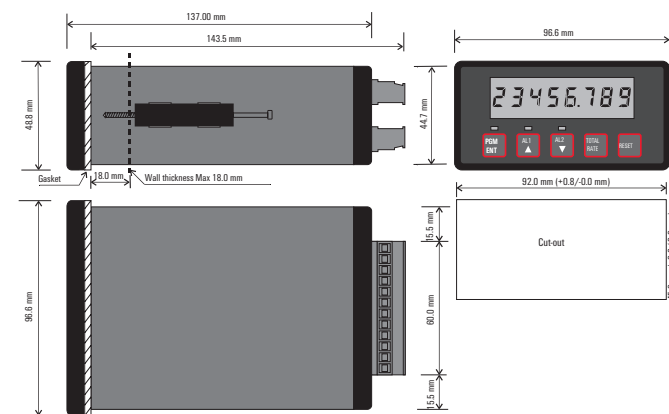
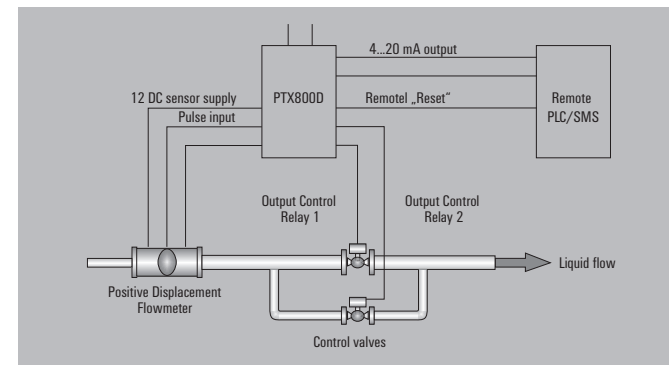

Technical Features

- Display of the flow quantity/rate
- Easily-readable eight-digit LED display
- Up to two outputs for alarm monitoring or control
- Optional analogue output
- Pulse output
- Reset function can be controlled locally or remotely, for fill-quantity monitoring (batching)
- The most recent measured value is stored in case of a power outage
- DC power supply
- LED display for values outside of range
- Complete electrical isolation
- DIN-standard 1/8 front panel with IP 65 protection
- Integrated power supply for initiators
- Changing the device configuration is possible without performing a new calibration
- No internal adjustments needed

Process value displays with LED display

Indicators and configurable displays

Common technical data

Display	
Type	Eight digits, red LED, 7.2 mm
Brightness	Adjustable to 14 levels of brightness
Display value	Percent or real-value displayed
Partial display	Display from 0 to 50,000 (five digits)
Time range, partial display	per sec., min., hour (PT800A also per day)
Total display	Display from 0 to 99,999,999 (8 digits)
Decimal point	Adjustable separately for partial and total display
Status indicator	Alarm 1/2; Status LED
Pulse output	
Type	Transistor output
Display value	One pulse per signal jump of the total display
Pulse duration	32 ms
Cut-off time	Minimum of 32 ms
Analogue output (optional)	
Type	Current or voltage output configurable with jumper
Display range	Dependent on the calibration (within 0 to 22 mA, or 0 to 11 V)
Resolution	1.6 µA or 0.8 mV / Bit
Load resistance, current	≤ 900 Ω
Load resistance, voltage	≥ 1 kΩ
Residual ripple	< 20 mV _{rms}
Alarm output (optional)	
Type	2 relay contacts (CO)
Switching current	3 A at 240 V AC, 5 A at 24 V DC / 110 V AC (resistive load)
Isolation	1.5 kV between ports
Input reset	
Type	Normally open
Function	Complete reset (display/alarm)
General information	
Supply voltage	24 V DC ±10 %
Power consumption	6 W at 24 V DC
Accuracy	< 0.05 %
Linearity	< 0.05 %
Repeat accuracy	± 0.02 % of signal range
Humidity	0...90 % (no condensation)
Temperature coefficient	< 0.02 % of signal range
Long-term drift	0.1 % / 10,000 h
Impulse withstand voltage	4 kV (1.2/50 µs)
Ambient temperature (operational)/storage temperature	0 °C...60 °C / -25 °C...70 °C

Connections

Terminal	Signal	
1	L+	Supply voltage
2	L-	
3	Signal +	Analogue output (optional)
4	Signal -	
5	0 V	Pulse output
6	Pulse	
7		Inputs
8		
9	Optional, depending on type	
10		
11		
12		Alarm channel 1 (optional)
13	NO contacts	
14	Common	Alarm channel 2 (optional)
15	NC contact	
16	NO contacts	Alarm channel 2 (optional)
17	Common	
18	NC contact	

F

Process value displays with LED display

PTX800 Series

Counter and totaliser with additional functionality and limit-value monitoring

- Installation in control panels
- Pluggable connection terminals
- Scalable impulse and frequency counters for digital input signals
- Suitable on input side for all standard initiators

PTX800D

Digital pulse input

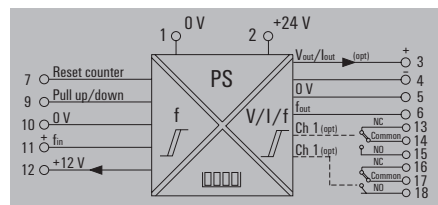
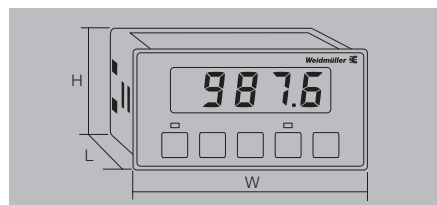

Technical data

Input	
Type	Digital pulse (NAMUR, PNP/NPN, TTL logic, optocoupler, voltage pulse, no-voltage contacts)
Input signal	0...10 Hz
Sensor supply	12 V DC to 25 mA
Input voltage	50 mV...250 V adjustable
Total display, display range	Configurable (≤ 10 pulse per signal jump)
Analogue output (optional)	
Type (analogue output)	Current of voltage output, configured with jumper
Input reset	
Pulse duration, min.	100 ms
Pulse output	
Pulse rate, max.	16 / s
General data	
Type	RO/AO version with 1 analogue output and 2 alarm outputs
EMC standards	DIN EN 61326
Approvals	CE, cULus, EAC

Type	Digital pulse (NAMUR, PNP/NPN, TTL logic, optocoupler, voltage pulse, no-voltage contacts)
Input signal	0...10 Hz
Sensor supply	12 V DC to 25 mA
Input voltage	50 mV...250 V adjustable
Total display, display range	Configurable (≤ 10 pulse per signal jump)
Type (analogue output)	Current of voltage output, configured with jumper
Pulse duration, min.	100 ms
Pulse rate, max.	16 / s
Type	RO/AO version with 1 analogue output and 2 alarm outputs
EMC standards	DIN EN 61326
Approvals	CE, cULus, EAC

Connections

Terminal	Signal	
7	Reset by connection to class 12	Reset
8	Setup configuration by connection to class 12	Configuration
9	Pull Up / Down	Inputs
10	Signal - / 0 V	
11	Signal +	
12	12 V DC	

Dimensions	
Clamping range (nominal / min. / max.)	1.5 / 0.5 / 2.5
Length x width x height	137 / 96.6 / 48.8
Note	

Screw connection	
Clamping range (nominal / min. / max.)	1.5 / 0.5 / 2.5
Length x width x height	137 / 96.6 / 48.8
Note	

Ordering data

with analogue/alarm output	PTX800D RO/AO	1	7940012323
without analogue / alarm output	PTX800D	1	7940011133

Type	Qty.	Order No.
with analogue/alarm output	1	7940012323
without analogue / alarm output	1	7940011133

Note	

Note	

Accessories

Note	

Note	

Process value displays with LED display

Indicators and configurable displays

PTX800 Series

Counter and totaliser with additional functionality and limit-value monitoring

- Installation in control panels
- Pluggable connection terminals
- Configurable for analogue current and voltage signals
- Linearisation and interference suppression
- Power supply for external sensors

PTX800A

Analogue current input / voltage input

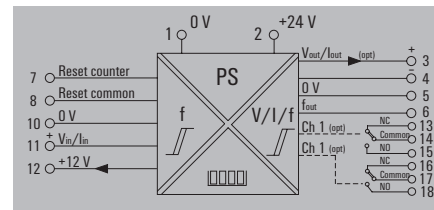
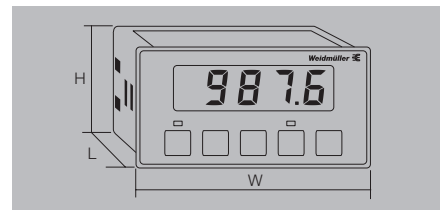

Technical data

Input	
Type	Conversion of linear/quadratic input signals into analogue signals
Input signal	-24...+24 mA / -11...+11 V
Sensor supply	24 V DC (up to 25 mA)
Resolution	0.6 μ A / 0.3 mV
Input resistance	22 Ω (current input); 1 M Ω (voltage input)
Total display, display range	0,001; 0,01; 0,1; 1; 10; 100; 1000
Analogue output (optional)	
Type (analogue output)	Current of voltage output, configured with jumper
Input reset	
Pulse duration, min.	250 ms
Pulse output	
Pulse rate, max.	15 / s
General data	
Type	RO/AO version with 1 analogue output and 2 alarm outputs
EMC standards	DIN EN 61326
Approvals	CE; cULus; EAC

Dimensions	
Clamping range (nominal / min. / max.)	1.5 / 0.5 / 2.5
Length x width x height	137 / 96.6 / 48.8
Note	

Connections

Terminal	Signal	
7	Reset by connection to class Kl. 8	Reset
8	Common	
9	Setup configuration by connection to class 8	Configuration
10	Signal - / 0 V	Inputs
11	Signal +	
12	24 V DC	

F

Dimensions	
Clamping range (nominal / min. / max.)	1.5 / 0.5 / 2.5
Length x width x height	137 / 96.6 / 48.8
Note	

Screw connection	
Clamping range (nominal / min. / max.)	1.5 / 0.5 / 2.5
Length x width x height	137 / 96.6 / 48.8
Note	

Ordering data

	with analogue/alarm output	PTX800A 4-20mA/RO/AO	1	7940014374
	without analogue / alarm output	PTX800A 4-20mA	1	7940010243

Type	Qty.	Order No.
with analogue/alarm output	1	7940014374
without analogue / alarm output	1	7940010243

Note	
-------------	--

Note	
-------------	--

Accessories

Note	
-------------	--

Note	
-------------	--

Indicators and configurable displays for analogue signals PMX420 SERIES

Universal, 4-digit, current/voltage displays

The current/voltage displays of the PMX420 SERIES are available as a pure display unit or optionally with analogue outputs/4 alarm outputs.

The basic model is suitable for displaying a wide range of bipolar mA or voltage signals. Inputs are isolated from the power supply. An integrated power source is available for supplying external sensors and transmitters.

The PMX420 Plus adds four alarm channels (each with its own status indicator and relay contact outputs) and a fully isolated analogue current/voltage output.

Device functions can be configured, specifically for the application, using the integrated keypad on the front panel. There are also several other handy features like maximum and minimum value recall, integrated linearisation, an acoustic alarm, a group alarm function, and the option for manual or automatic alarm reset.

Technical features:

- 4-digit LED display
- Suitable for current and voltage signals
- Bipolar inputs
- Integrated square root function
- Retrieval of min. and max. values
- Integral power supply for active sensors
- DC power supply
- Complete electrical isolation
- Four alarm channels and an analogue current/voltage output (PMX420 Plus)
- LED alarm status indication
- DIN-standard 1/8 front panel with IP 65 protection
- Decimal point can be adjusted to any position
- Configurable via front-panel keypad

Typical application of PMX420 Plus

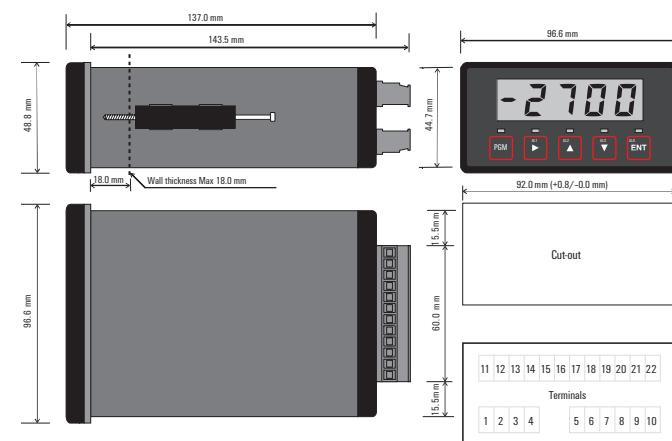
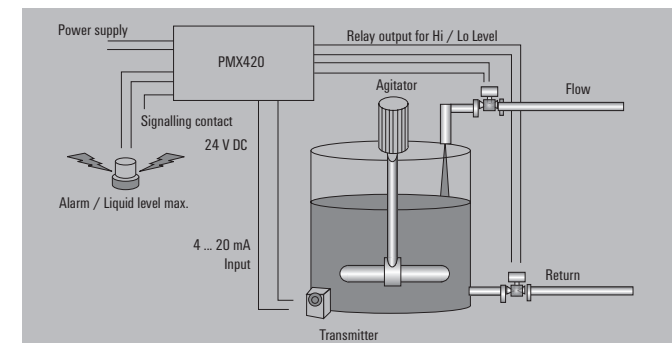

Process value displays with LED display

Indicators and configurable displays

Common technical data

Display	
Type	4 Digits, red LED, 14.2 mm
Display value	Percent or real-value displayed
Display range	9999 to +9999
Status indicator	Alarm channel 1-4; status LED
Input	
Type	Current or voltage input is programmable
Input current limits	-22...+22 mA (preset for 4...20 mA)
Input voltage limits	-11...+11 V
Input resistance	25 Ω (current input) or 1.5 MΩ (voltage input)
Resolution	4 µA / 2 mV
Sensor current	4...20 mA
Feed voltage	24 V DC ±1.5 V DC (bis 25 mA)
Attenuation factor	0...99; programmable digital filter
Functions	
Values	Linear or $\sqrt{\quad}$
General information	
Supply voltage	18...50 V DC, other voltages on request
Power input	8.5 W @ 24 V DC
Accuracy	Typically ± 0.1 % of signal range
Linearity	< 0.05 %
Repeat accuracy	±0.02 of signal range
Humidity	0...90 % (no condensation)
Temperature coefficient	< 0.02 % / °C at 100 %
Long-term drift	0.1 % / 10.000 h
Cut-off frequency (-3 dB)	5 Hz
Step response time	300 ms (10...90 %)
Impulse withstand voltage	4 kV (1,2/50 µs)
Isolation voltage	2 kV input / output / power supply
Data backup	> 10 years without power supply
Ambient temperature (operational)/storage temperature	0 °C...60 °C / -25 °C...+70 °C
EMC standard	DIN EN 61326
Approvals	CE, cULus

Connections

Terminal	Signal	
1	-	Supply voltage
2	+	High level
3	+	Supply voltage
4	-	Low level
5	Signal + sensor supply	Inputs
6	Configuration	
7	Signal + voltage input	
8	Signal + current input	
9	Signal 0 V	
10	Not used	
11	NC contact	Alarm channel 1
12	Common	(only PMX-420Plus)
13	NO contacts	
14	NC contact	Alarm channel 2
15	Common	(only PMX420Plus)
16	NO contacts	
17	NO contacts	Alarm channel 3
18	Common	(only PMX420Plus)
19	NO contacts	Alarm channel 4
20	Common	(only PMX420Plus)
21	Signal +	Analogue Output
22	Signal -	(only PMX420Plus)

F

Process value monitoring with LED display

PMX420 Series

- Universal, 4-character current/voltage display
- Display instrument for control panel installation
 - Pluggable connection terminals
 - 4-character, scalable display
 - Simple menu-driven configuration

PMX420Plus

Display with analogue output and 4 alarm channels

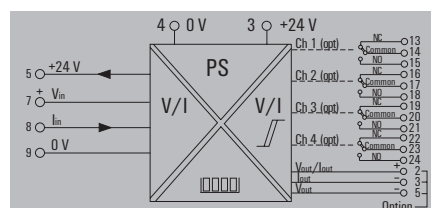
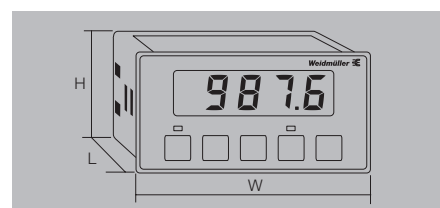

Technical data

Alarm	
Type	Adjustable output for current or voltage
Scaling	Variable
Output current	0...22 mA
Output voltage	0...11 V
Transmit function	direct or inverted
Load impedance, voltage/current	850 Ω @ 20 mA (current output) / < 500 Ω (voltage output)
Residual ripple	≤ 20 mV _{ms}
Alarm	
Type	Internal Alarm via LED or output signal to external controller
Number of channels	4
Type of contact	2 CO contact und 2 NO contacts
Switching current	5 A @ 240 V AC, 10 A @ 24 V DC
Insulation voltage	2 kV input / power supply
Leakage current quenching	internal

Connections

Terminal	Signal	
1	-	Supply voltage
2	+	High level
3	+	Supply voltage
4	-	Low level
5	Signal + sensor supply	Inputs
6	Configuration	
7	Signal + voltage input	
8	Signal + current input	
9	Signal 0 V	
10	Not used	
11	NC contact	Alarm channel 1
12	Common	
13	NO contacts	Alarm channel 2
14	NC contact	
15	Common	Alarm channel 3
16	NO contacts	
17	NO contacts	Alarm channel 4
18	Common	
19	NO contacts	Analogue Output
20	Common	
21	Signal +	
22	Signal -	

Dimensions	
Clamping range (nominal / min. / max.)	1.5 / 0.5 / 2.5
Length x width x height	137 / 96.6 / 48.8
Note	

Ordering data			
Type	Qty.	Order No.	
Voltage input/Current input	1	7940018957	
Note			

Accessories	
Note	

Process value monitoring with LED display

Indicators and configurable displays

PMX420 Series

- Universal, 4-character current/voltage display
- Display instrument for control panel installation
- Pluggable connection terminals
- 4-character, scalable display
- Simple menu-driven configuration

PMX420

Display

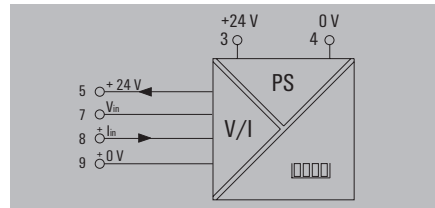
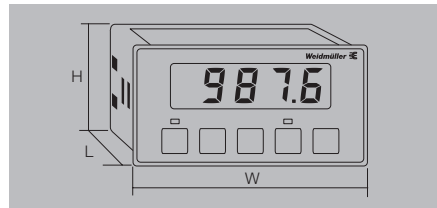

Technical data

Display	
Type	4-digit, red LED, 14.2 mm
Scaling	
Display range	-9999...9999
Status indicator	

Inputs	
Type	Adjustable input for current or voltage
Input current	±22...±22 mA (preset to 4...20 mA)
Input resistance	25 Ω (current input) or 1.5 MΩ (voltage input)
Resolution	4 μA / 2 mV
Sensor current	4...20 mA
Current output	
Transfer functions	

Power supply	
Supply voltage	18...50 V DC, other voltages on request

Input	
Attenuation factor	0...99, programmable digital filter

General data	
Sampling rate	
Linearity	< 0.05 %
Repeat accuracy	
Temperature coefficient	
Long-term drift	0.1 % / 10.000 h
Cut-off frequency (-3 dB)	5 Hz
Step response time	

Insulation coordination	
Rated voltage	
Overvoltage category	
Impulse withstand voltage	4 kV (1.2/50 μs)
Insulation voltage	2 kV input / power supply
Ambient temperature (operational)	0 °C...60 °C
Storage temperature	-25 °C...70 °C
Pollution degree	
Humidity	0...90 % (no condensation)

Dimensions	
Clamping range (nominal / min. / max.)	1.5 / 0.5 / 2.5
Length x width x height	137 / 96.6 / 48.8

Note	

Ordering data

Voltage input/Current input	
-----------------------------	--

Type	Qty.	Order No.
PMX420	1	7940018956

Note	

Accessories

Note	

Connections

Terminal	Signal	
1	-	Supply voltage
2	+	High level
3	+	Supply voltage
4	-	Low level
5	Signal + sensor supply	Inputs
6	Configuration	
7	Signal + voltage input	
8	Signal + current input	
9	Signal 0 V	
10	Not used	

F

Indicators and configurable displays for temperature

PMX400 SERIES

Four-digit temperature and frequency displays with analogue-value read-out and alarm monitoring

The PMX400 SERIES consists of two modules:

- Temperature display
- Frequency display / tachometer

A variety of temperature or frequency signals can be processed. On the output side, optional analogue signals are available, as well as either two or four relay contacts for alarm monitoring. The PMX400 HZX frequency display module offers, as default, two open-collector outputs as the relay contacts. The outputs are designated for the alarm function. An integrated power supply can be used for supplying external sensors and input devices.

Technical features:

- Four-digit digital LED display
- Up to four alarm channels and an analogue current/voltage output
- Retrieval of min. and max. values
- Integral power supply for active sensors
- DC power supply
- Complete electrical isolation
- LED alarm status indication
- DIN-standard 1/8 front panel with IP 65 protection
- Decimal point can be adjusted to any position
- Configurable via front-panel keypad

Typical application of PMX400

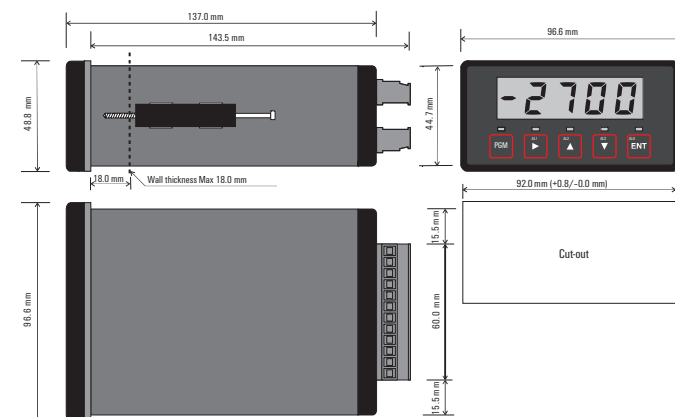
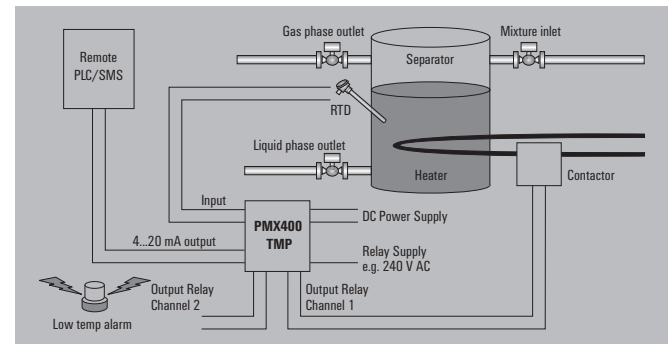

Process value displays with LED display

Indicators and configurable displays

Common technical data

Display	
Type	Four-digit, red LED, 14.2 mm
Display value	Percent or real-value displayed
Display range	-9999 to +9999
Status indicator	Alarm channel 1-4; Status LED
Output	
Type	Current or voltage output
Scaling	Variable
Output signal limits	0...20 mA or 0...11 V
Load resistance	≤ 850 Ω (current), ≥ 1 MΩ (voltage)
Residual ripple	< 20 mV _{rms}
Transmit function	direct or reverse
General information	
Accuracy	Typically ± 0.1 % of signal range
Linearity	≥ 0.05 %
Repeat accuracy	± 0.02 % of signal range
Humidity	0...90 % (no condensation)
Temperature coefficient	≤ 0.02 % / °C
Long-term drift	0.1 % / 10,000 h
Cut-off frequency (-3 dB)	5 Hz
Impulse withstand voltage	4 kV (1.2/50 μs)
Isolation voltage	1 kV input / output / power supply
Data backup	≥ 100 years (without power supply)
Ambient temperature (operational)/storage temperature	0 °C...60 °C / -25 °C...75 °C
EMC standard	DIN EN 61326
Approvals	CE, cULus

Connections

Terminal	Signal		
1	-	Supply voltage	
2	+		
3	Signal +		
4	Signal - current		
5		Optional, depending on type	
6			
7			
8			
9			
10			
11			
12			
13	NO contacts		Alarm channel 1 (only for 4RO version)
14	Common		
15	NC contact		Alarm channel 2 (only for 4RO version)
16	NO contacts		
17	Common		
18	NC contact		
19		Depending on the individual module	
20			
21			
22			
23			
24			

F

Process value displays with LED display

PMX400 Series

- Temperature measuring and monitoring (PT100, thermocouple, mV)
- Automatic sensor detection
- Automatic compensation for PT100 measurement leads
- Cold-junction compensation for thermocouple inputs
- Display instrument for control panel installation

PMX400TMP

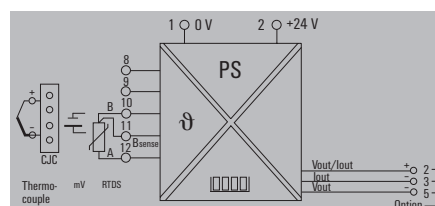
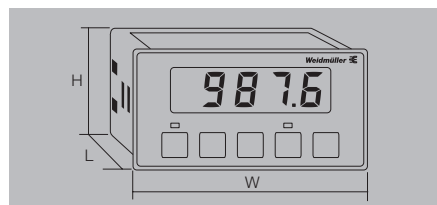

Technical data

Display	
Display value	Percentage or real value display
Input	
Type	Thermocouple, PT100 RTD or mV
Input signal	Configurable for 10 ranges
cold junction compensation	automatic
Cable-length compensation	automatic
General data	
Supply voltage	20...28 V DC
Power consumption	6 W @ 24 V DC
Step response time	300 ms (10...90 %)
Sampling rate	5x pro s
Attenuation factor	0...99, programmable digital filter
Type	4-digit, red LED, 14.2 mm
	Voltage input/ current input
Insulation voltage	1 kV input / output / power supply
EMC standards	DIN EN 61326
Approvals	CE, cULus, EAC

Connections

Terminal	Signal	
1	-	Supply voltage
2	+	
6	Connections for changing setup	Configuration
7		
8		Thermocouple inputs
9	Cold-junction compensation	
10		
11		RTD inputs
12	Not used	
8	Not used	
9		mV inputs
10	B	
11	B-Sense	
12	A	
8	Not used	
9	Not used	
10	mV Signal -	
11	mV Signal +	
12	Not used	

Thermocouple (type J, K, N, T, E, B, S, R), RTD or mV signals

Input Type	Max. display range	
	highest	lowest
J	870 °C (1598 °F)	-50 °C (-58 °F)
K	1372 °C (2502 °F)	
N	1300 °C (2372 °F)	
T	400 °C (752 °F)	
E	700 °C (1292 °F)	
B	1800 °C (3272 °F)	0 °C (32 °F)
S	1768 °C (3214 °F)	-50 °C (-58 °F)
R	1768 °C (3214 °F)	-50 °C (-58 °F)
RTD	820 °C (1508 °F)	-220 °C (-364 °F)
mV	200 mV	-200 mV

Dimensions	Screw connection
Clamping range (nominal / min. / max.)	1.5 / 0.5 / 2.5
Length x width x height	137 / 96.6 / 48.8
Note	

Ordering data

Type	Qty.	Order No.
without analogue / alarm output PMX400TMP	1	7940017862

Note	

Accessories

Note	

Process value displays with LED display

Indicators and configurable displays

PMX400 Series

- Frequency measuring and monitoring (3-wire NPN/PNP, NPN/PNP Open Collector, TTL logic, solid-state switch, potential-free contacts)
- Integrated power supply for external sensors
- Two outputs for monitoring limit-values
- De-bouncing of switched input pulses

PMX400HZX

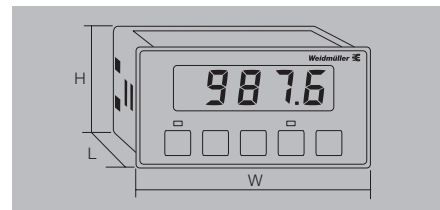

Technical data

Display	
Display value	Percentage or real value display
Input	
Type	Adjustable frequencies
Input signal	Configurable for 4 ranges
Sensor supply	12 V DC to 25 mA
Input voltage	
Alarm (channel 1/2)	
Type	Channel 1/2: transistor output channel 3/4: relay contact (CO)
Rated switching current	200 mA
Rated switching voltage	50 V DC
Alarm (channel 3/4)	
Type	Channel 1/2: transistor output channel 3/4: relay contact (CO)
Switching current	Channel 3/4: 3 A @ 240 V AC / 24 V DC (resistive load)
General data	
Supply voltage	24 V DC ± 10 %
Power consumption	6 W @ 24 V DC
Step response time	< 220 ms (10...90 %)
Attenuation factor	0...99, programmable digital filter
Type	RO/AO version with 1 analogue output and 2 alarm outputs
Insulation voltage	1 kV input / output / power supply
EMC standards	DIN EN 61326
Approvals	CE, cULus, EAC

Dimensions	
Clamping range (nominal / min. / max.)	1.5 / 0.5 / 2.5
Length x width x height	137 / 96.6 / 48.8
Note	

Ordering data

with analogue/alarm output	PMX400HZX RO/AO	1	7940011979
without analogue / alarm output	PMX400HZX	1	7940015595

Note

Accessories

Note

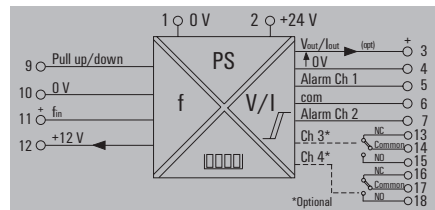

Connections

Terminal	Signal	Description
1	-	Supply voltage
2	+	
3	Signal +	Analogue output
4	Signal -	(only for AO version)
5	Common	Alarm channel 1 and 2
6	Channel 1	(only for 4RO version)
7	Channel 2	
8	Configuration	
9	Pull up / pull down	Inputs/Configuration
10	Signal -	(Set-up: 12/8 connection)
11	Signal +	
12	12 V DC	
13	Common	Alarm channel 3
14	NC contact	(only for 4RO version)
15	NO contacts	
16	Common	Alarm channel 4
17	NC contact	(only for 4RO version)
18	NO contacts	

Input range	Offset	Resolution
0...9.999 Hz	0...9.998 Hz	0.001 Hz
0...99.99 Hz	0...99.98 Hz	0.01 Hz
0...999.9 Hz	0...999.8 Hz	0.1 Hz
0...9999 Hz	0...9998 Hz	1 Hz

F

Process value displays with LED display

Universal auto-manual stations AMS400A

Universal auto-manual stations

The AMS400A modules are interface devices which are used between controllers / PLCs and valves / actuators in the field. They implement auto-manual transfer operations for automatically controlled processes.

Typical applications are:

- Manual start-up of sensitive processes before handover to automatic control
- Manual over-ride in case of controller failure or malfunction.

The AMS400A offers three different I/O configurations, which serve as interfaces between:

- Analogue control equipment and analogue control devices
- Digital control equipment and analogue control devices
- Digital control equipment and digital control devices

In AA (analogue-analogue) mode, it is possible for a remote source to switch between manual and automatic operations using digital inputs. Ramp rates and additional handover. Two options are available for the method of returning to automatic control, in order to ensure a bumpless transfer.

Typical application of AMS400A

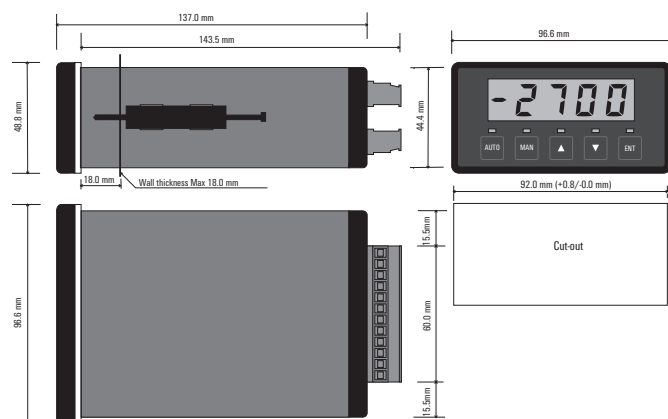
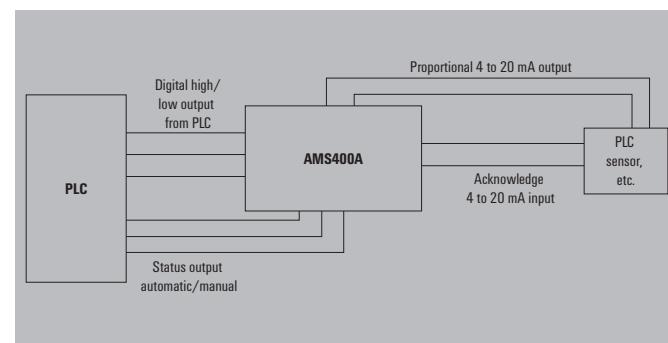

Process value displays with LED display

Indicators and configurable displays

AMS400A

- Universal interface device
- Display instrument for control panel installation
- 1/8 DIN standard front
- IP 65 fully insulated
- Pluggable connection terminals

AMS400A

Universal interface device

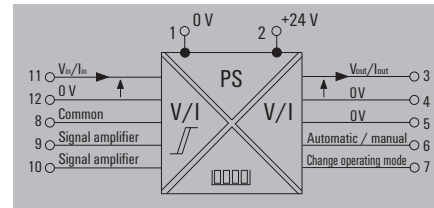
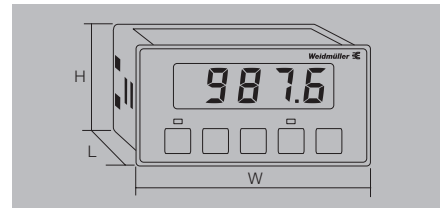

Technical data

Display	
Type	4-digit, red LED, 14.2 mm
Display value	Percentage or real value display
Display range	-9999...9999
Input	
Type	Current input or digital input (pulse-controlled or no-voltage contact)
Input signal	0...24 mA / 0...12 V DC
Input resistance	50 Ω (mA) / 10 MΩ (V)
Sampling rate	5x per sec. (current input)
Pulse width, min.	64 ms (digital input)
Output	
Type	Analogue and digital output
Output analogue	Current or voltage, configured with jumper
Output current	0...24 mA
Output voltage	0...18 V
Last resistor, max.	900 Ω @ 20 mA
Alarm (RO version only)	
Type	Status relay
Number of channels	2
Type of contact	CO contact
Ratings	3 A @ 240 V AC or 5 A @ 24 V DC
General data	
Supply voltage	24 V DC ± 10 %, other voltages on request
Power consumption	6 W @ 24 V DC
Accuracy	Typically ± 0.1 % of signal range
Repeat accuracy	± 0.02 % of signal range
Temperature coefficient	≤ 0.02 % / °C
Cut-off frequency (-3 dB)	5 Hz
Step response time	300 ms (10...90 %)
Impulse withstand voltage	4 kV (1.2/50 μs)
Insulation voltage	1 kV input / output / power supply
Ambient temperature / Storage temperature	/ 0 °C...60 °C / -25 °C...70 °C
EMC standards	DIN EN 61326
Approvals	CE; cULus; EAC
Dimensions	
Clamping range (nominal / min. / max.)	1.5 / 0.5 / 2.5
Length x width x height	137 / 96.6 / 48.8
Note	

Connections

Terminal	Signal	
1	-	Supply voltage
2	+	
3	Signal +	Analogue Output
4	Signal -	
5	Signal - 0 V	Status outputs
6	Automatic / manual	
7	Change operating mode	
8	Common	Digital inputs
9	Signal amplifier	
10	Signal reduction	
11	Signal +	Analogue inputs
12	Signal -	

F

Ordering data

Analogue output

Type	Qty.	Order No.
AMS400A 4-20mA/AO	1	7940011895

Note

Accessories

Note

Process value displays with LED display

Indicators with scalable displays

DI350

3½-digit LED display, auxiliary powered

The DI350 is a pair of inexpensive 3½-digit displays - one for analogue current (4-20 mA) and the other for voltage (0-10 V) signals, for use in industrial applications.

An integrated regulated power supply can be used to supply two-wire transmitters.

The decimal point can be moved to any of the positions (1.XXX, 1X.XX, 1XX.X or 1XXX) so that it can display values in any range.

The bright seven-segment LEDs are easily visible even in weak lighting. The special filtering properties of the front face give it a wide viewing angle.

The DIN-standard 1/8 front panel with IP 65 protection ensures reliable operation in wet areas. The connection uses pluggable screw-connection elements.

The DI350 models are hazardous area approved cuLus Ex (Class 1 Div. 2, Groups A, B, C & D)

Typical application of DI350

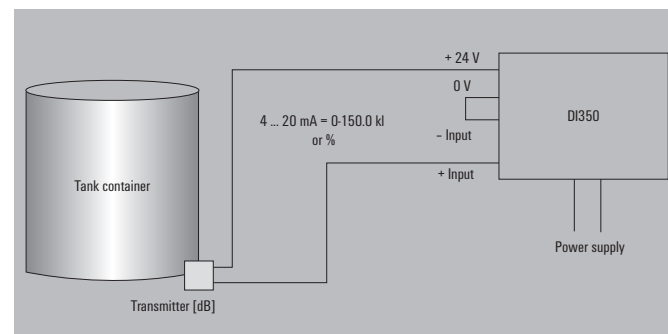

Wiring diagramm DI350

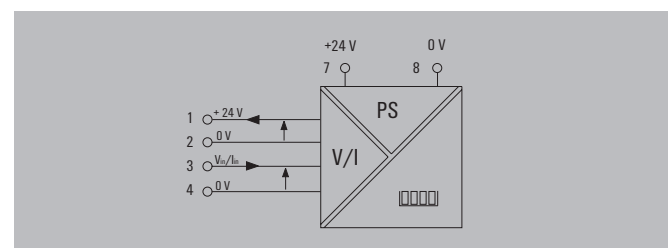

Connections

Terminal	Signal	
1	24 V DC power supply sensor	Inputs
2	0 V DC power supply sensor	
3	Input signal +	
4	Input signal -	
5		
6	Not used	
7	L -	Supply voltage
8	L +	

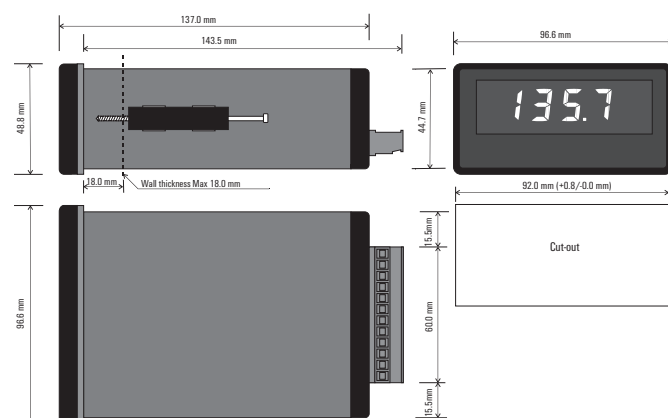

Process value displays with LED display

DI350

- Display instrument for control panel installation
- 1/8 DIN standard front
- 3½ digits
- IP 65 fully insulated
- Pluggable connection terminals

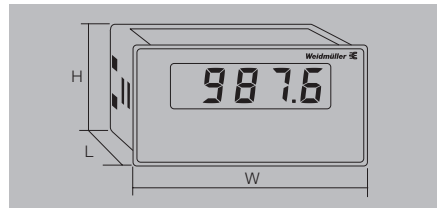

Technical data

Input
Input signal
Input resistance
Supply voltage
Display
Type
Display range
Display value
Format
Settings
Offset
Range of adjustment
General data
Supply voltage
Power consumption
Linearity
Humidity
Temperature coefficient
Long-term drift
Step response time
Impulse withstand voltage
Insulation voltage
Ambient temperature / Storage temperature
EMC standards
Approvals

DI350

Display with voltage input



- Integrated power supply for external sensors
- Linearity with an accuracy of 0.1 % of the measuring range
- Complete galvanic isolation

Input signal	0...10 V
Input resistance	1 MΩ
Supply voltage	24 V DC (up to 25 mA)
Type	3.5 digits, red LED, 14.2 mm
Display range	-1999...1999
Display value	Percentage or real value display
Format	1-line / decimal point: 1.000, 100.0, 10.00
Offset	± 1200 digital steps
Range of adjustment	20 - 2100 digital steps
Supply voltage	24 V DC (12...35 V DC)
Power consumption	6 W @ 24 V DC
Linearity	< 0.1 % typ.
Humidity	0...90 % (no condensation)
Temperature coefficient	≤ 0.02 % / °C
Long-term drift	0.1 % / 10.000 h
Step response time	200 ms (10...90 %)
Impulse withstand voltage	4 kV (1.2/50 μs)
Insulation voltage	1 kV input / power supply
Ambient temperature / Storage temperature	/ 0 °C...60 °C / -25 °C...70 °C
EMC standards	DIN EN 61326
Approvals	CE; cULus; cULusEX; EAC

DI350

Display with current input



- Integrated power supply for external sensors
- Linearity with an accuracy of 0.1 % of the measuring range
- Complete galvanic isolation

Input signal	4...20 mA
Input resistance	22 Ω
Supply voltage	24 V DC (up to 25 mA)
Type	3.5 digits, red LED, 14.2 mm
Display range	-1999...1999
Display value	Percentage or real value display
Format	1-line / decimal point: 1.000, 100.0, 10.00
Offset	± 1200 digital steps
Range of adjustment	20 - 2100 digital steps
Supply voltage	24 V DC (12...35 V DC)
Power consumption	6 W @ 24 V DC
Linearity	< 0.1 % typ.
Humidity	0...90 % (no condensation)
Temperature coefficient	≤ 0.02 % / °C
Long-term drift	0.1 % / 10.000 h
Step response time	200 ms (10...90 %)
Impulse withstand voltage	4 kV (1.2/50 μs)
Insulation voltage	1 kV input / power supply
Ambient temperature / Storage temperature	/ 0 °C...60 °C / -25 °C...70 °C
EMC standards	DIN EN 61326
Approvals	CE; cULus; cULusEX; EAC

Indicators and configurable displays

F

Dimensions

Clamping range (nominal / min. / max.)
Length x width x height

Note

Screw connection

1.5 / 0.5 / 2.5
137 / 96.6 / 48.8

Note

Screw connection

1.5 / 0.5 / 2.5
137 / 96.6 / 48.8

Note

Ordering data

Voltage input/Current input

Type	Qty.	Order No.
DI350 0-10V/0-100.0	1	7940011570

Note

Type	Qty.	Order No.
DI350 4-20mA/0-100.0	1	7940010185

Note

Accessories

Note

Note

Note

Indicators and configurable displays

LPD350

3½-digit digital display, loop powered

The LPD350 is a compact, cost effective, 3½ digit digital indicator designed specifically for current loop signals. The decimal point can be moved to any position (1.XXX, 1X.XX, 1XX.X or 1XXX) so that it can display values in a range of ± 1999 .

The LPD350 uses a liquid crystal display which can be read even under poor lighting conditions.

No additional wiring is needed for a power supply. The user can simply break the loop and connect to the LPD350.

The housing has a DIN-standard 1/8 front panel with IP 65 protection. The connection uses pluggable screw-connection elements.

Technical features:

- Large 3½-digit digital LCD display
- 4...20 mA input
- Loop-powered two-wire design (125 Ω loop load)
- Direct or reverse-action display
- Linearity is ± 0.1 % of the corresponding signal range
- DIN-standard front-panel with IP 65 protection
- Pluggable screw-connection mechanism
- Hazardous area approved cuLus Ex (Class 1 Div. 2, Groups A, B, C & D)

Typical application of LPD350

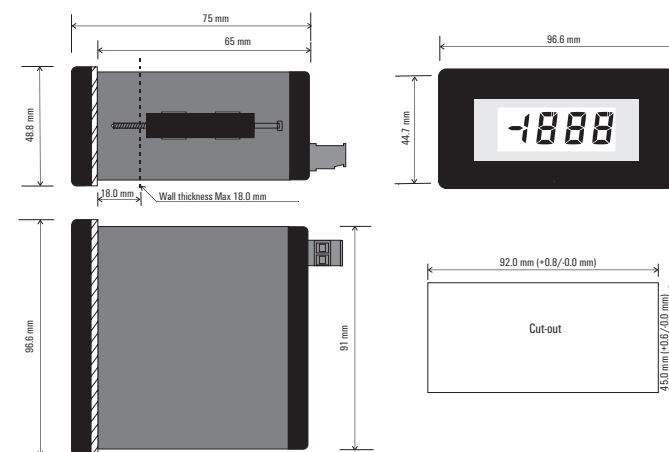
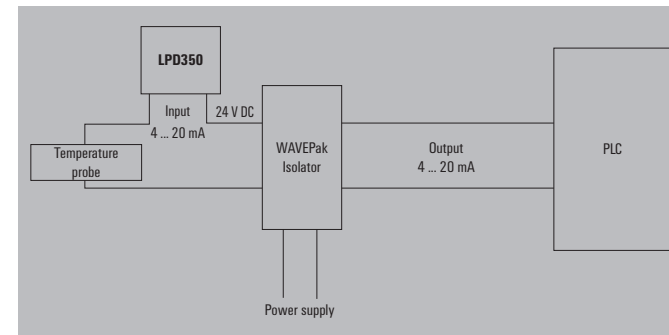

Process value displays with LCD display

Indicators and configurable displays

LPD350

- Display instrument for control panel installation
- 1/8 DIN standard front
- 3½ digits
- IP 65 fully insulated
- Pluggable connection terminals

LPD350

Current input

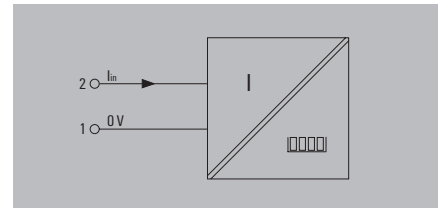
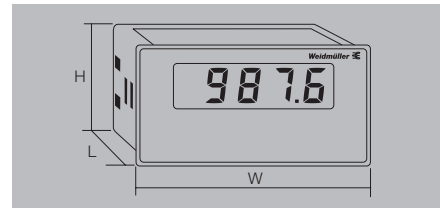

Technical data

Input	
Input current	4...20 mA
Voltage drop	2.5 V @ 20 mA
Input resistance	125 Ω
Input current, max.	100 mA constant / 500 mA for 10 s
Input current, max. when wired incorrectly	500 mA constant
Display	
Type	3.5 digits, black LCD with clear background, 12.7 mm
Display range	-1999...1999
Format	Single-line
Settings	
Offset	± 1999 digital steps in two switching ranges
Range of adjustment	0...3998 in three switching ranges
General data	
Accuracy	± 0.05 % from signal range ± 1 digital step
Repeat accuracy	± 0.05 % of signal range
Temperature coefficient	Offset ± 0.1 digital steps per °C adjustment range ± 0.1 digital steps per °C
Step response time	200 ms (10...90 %)
Sampling rate	2.5 x pro s
Ambient temperature / Storage temperature	/ -20 °C...70 °C / -25 °C...85 °C
EMC standards	DIN EN 61326
Approvals	CE; cULus; cULusEX; EAC

Input current	4...20 mA
Voltage drop	2.5 V @ 20 mA
Input resistance	125 Ω
Input current, max.	100 mA constant / 500 mA for 10 s
Input current, max. when wired incorrectly	500 mA constant
Type	3.5 digits, black LCD with clear background, 12.7 mm
Display range	-1999...1999
Format	Single-line
Offset	± 1999 digital steps in two switching ranges
Range of adjustment	0...3998 in three switching ranges
Accuracy	± 0.05 % from signal range ± 1 digital step
Repeat accuracy	± 0.05 % of signal range
Temperature coefficient	Offset ± 0.1 digital steps per °C adjustment range ± 0.1 digital steps per °C
Step response time	200 ms (10...90 %)
Sampling rate	2.5 x pro s
Ambient temperature / Storage temperature	/ -20 °C...70 °C / -25 °C...85 °C
EMC standards	DIN EN 61326
Approvals	CE; cULus; cULusEX; EAC

Connections

Terminal	Signal
1	Input -
2	Input +

F

Dimensions

Clamping range (nominal / min. / max.)	1.5 / 0.5 / 2.5
Length x width x height	75 / 96.6 / 48.8

Screw connection

Clamping range (nominal / min. / max.)	1.5 / 0.5 / 2.5
Length x width x height	75 / 96.6 / 48.8

Ordering data

Current input	
---------------	--

Type	Qty.	Order No.
LPD350 4-20mA/0-100.0	1	7940010163

Note

--

Accessories

Note

--

Configurable IP 67 field-mounted LCD indicator LPD405F

4½-digit display, loop powered

The display is loop powered by the 4...20 mA current loop with no external supply required. The twenty-mm LCD displays can be read even under poor light conditions.

A sheet of perforated self-adhesive labels is included. They include standard engineering units and can be used for all label needs.

The electronic subassembly is housed in a rugged, glass reinforced polycarbonate, IP 67 case. This housing is suitable for any industrial environment.

Optionally available is a pipe mounting bracket which can be used for horizontal and vertical mounting.

Technical features:

- Big 20 mm LCD display
- 4...20 mA inputs (two-wire loop-powered)
- Integrated signal linearisation ($\sqrt{\quad}$, $x^{3/2}$, $x^{5/2}$ or user-defined)
- Min./max. value display feature
- IP 67 protection
- Pipe mount bracket option
- Hazardous area approved cULus Ex (Class 1 Div. 2, Groups A, B, C & D)

Typical application of LPD450F

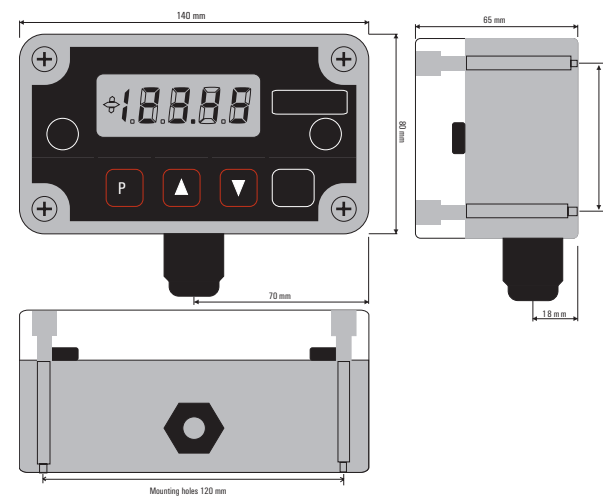
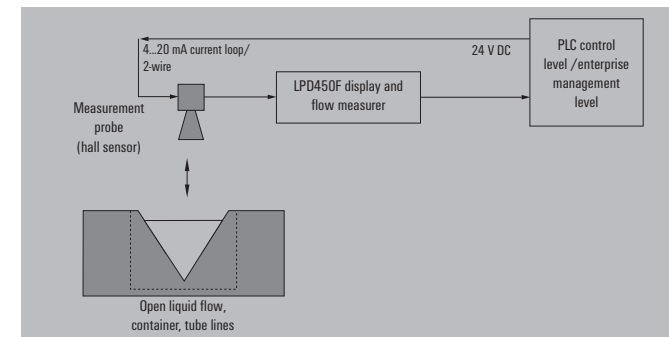

Process value displays with LCD display

Indicators and configurable displays

LPD450F

- Display instrument for outdoor use
- 4½ Digits
- IP 67 fully insulated
- Optionally available with fixing clips for pipe mounting

LPD450F

Current input

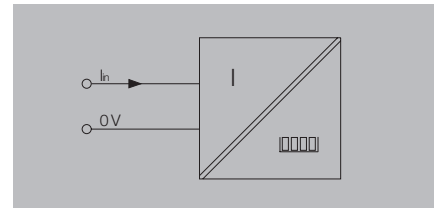
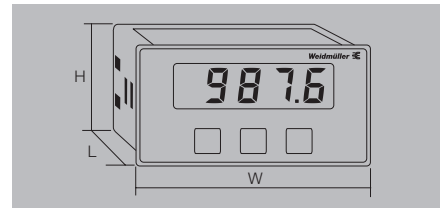

Technical data

Input
Input current
Transmit function
Display
Type
Display value
Display range
Decimal point
General data
Supply voltage
Voltage drop
Accuracy
Repeat accuracy
Temperature coefficient
Humidity
Step response time
Sampling rate
Change of display
Ambient temperature / Storage temperature
EMC standards
Approvals

4...20 mA
$\sqrt{\quad}$, $x^{0.2}$, $x^{0.7}$ or programmable (2-21 steps)
4.5-character, black LCD with clear background, 20 mm
Percentage or real value display
±19.999 (0.00...100.00 factory setting)
18888, 1.8888, 18.888, 188.88, 1888.8
Loop powered, via 4...20 mA input
< 4.3 V
± 0.05 % from signal range ± 1 digital step
± 0.01 % of signal range
Offset ± 0.01 % / °C
adjustment range ± 0.1 digital steps or 0.01 % / °C
10...90 % (no condensation)
Programmable in 99 steps from 1...30 sec.
16 x pro s
2 x per sec.
/ 0 °C...60 °C / -25 °C...70 °C
DIN EN 61326
CE; cULus; cULusEX; EAC

Mounting sketch

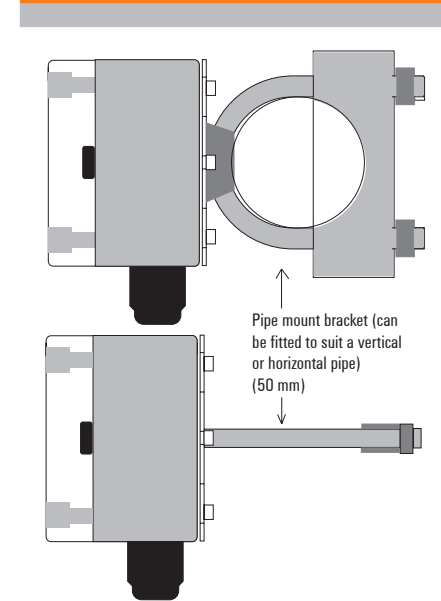

F

Dimensions

Clamping range (nominal / min. / max.)
Length x width x height
Note

Screw connection

1.5 / 0.5 / 2.5
65 / 140 / 80

Ordering data

Current input

Type	Qty.	Order No.
LPD450F 4-20mA	1	7940010236

Note

--

Accessories

Note

Fixing clip
Pipe Mount Kit - 7940010667

Accessories Analogue Signal Conditioning

Accessories Analogue Signal Conditioning	Accessories Analogue Signal Conditioning - Overview	G.2
	USB configuration adapter	G.4
	CH20M DIN rail bus	G.6
	ACT20 power-feed modules for rail bus	G.8
	ACT20X/ACT20C/ACT20P - Accessories	G.10
	MICROSERIES/ACT20M - Accessories	G.11
	MCZ/WAVE - Accessories	G.12
	Calibrators	G.14

G

Accessories Analogue Signal Conditioning

Configure, calibrate, mount, mark, (cross-) connect.

A comprehensive line of accessories is available for the analogue signal converter product family. The line includes configuration adapters for software-programmable products, interface modules, calibrators and mounting accessories (such as cross-connectors, end plates and terminal connectors) – all naturally in the top Weidmüller quality that you've come to expect.



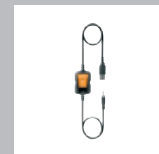

USB configuration interface



CH20M DIN rail bus



Power supply modules for rail bus



ACT20X/ACT20P - Accessories

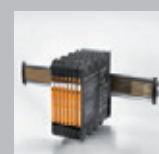

**MICROSERIES ACT20M
Accessories**



MCZ/Wave Accessories



Calibrators

USB configuration adapter

CBX200

CBX200 USB



The CBX200 USB is a USB2.0/RS232-interface converter with galvanic isolation. It has additional functionality for controlling and supplying the connected RS232 device. The CBX200 USB makes it possible to configure the intrinsically safe ACT20X product line and the WAVE TTA signal converter.
The CBX200 USB is not compatible with the CBX100 USB.

Technical data

Input	
Type	USB 2.0 (USB type A plug)
Input current	≤ 100 mA
Input resistance	22 kΩ
Input voltage	1.6 ... 5.6 V
Output	
Type	RS232 (4-pole 2.5-mm jack plug)
Output voltage	3.3 V regulated
Output current	3 A
Level on interfaces	1.8...5.6 V (automatically adapted)
Baud rate	≤ 115 kBd
Activation signal	9...15 V typ. 12 V / 4 mA
Insulation coordination	
Insulation voltage	2.5 kV (input / output)

Table for selecting a configuration adapter

Product	CBX100	CBX200
ACT20X		X
WAVE TTA	X	X
ITX+	X	

Pin assignments for jack plug



DTR*	Vcc
0	3.3 V
1	0 V

Control input	RTS*	RS232 interface
12 V	1	active
12 V	0	active
0 V	1	active
0 V	0	not active

* RTS and DTR are internal control signals

Installation notes

The power supply to the device comes from the USB port via a USB type-A plug. The output-side of the RS232 interface uses a four-pole 2.5-mm jack plug to connect. This jack plug is also capable of activating the RS232 interface when needed with a 12-V control voltage. With the assistance of the DTM, the USB interface is diverted to a COM interface. The RS232 interface can be activated with an RTS signal (RTS = 1 → output activated) via the diverted COM interface. The jack plug is also capable of supplying the RS232 node with a regulated voltage of 3.3 V at 4 mA current. The DTR signal (DTR = 0 → supply activated) is used for control. It is also possible to query the status using the DSR signal (DSR = 0 → output activated).

The "W-Manager" software, the "TTA Set" and the DTM library can all be downloaded free of charge from www.weidmueller.com.

Note

Ordering data

Type	Qty.	Order No.
CBX200 USB	1	8978580000

Note

Accessories

Note

CH20M DIN rail bus

CH20M DIN rail bus

Quick and safe power supply through the mounting rail.

This customer-friendly infrastructure solution brings power, signals and data to the rail in a quick and reliable manner. The DIN rail bus can replace the tedious individual wiring process with a flexible and uninterrupted system solution. As a result, the wiring overhead and the error rate are both reduced. The uninterrupted system bus is securely integrated within the 35 mm standard mounting rail. Whether 7.5 mm or 15 mm high, the custom-fit rail profiles are easy to install on all TS 35 standard rails in accordance with DIN EN 60715.

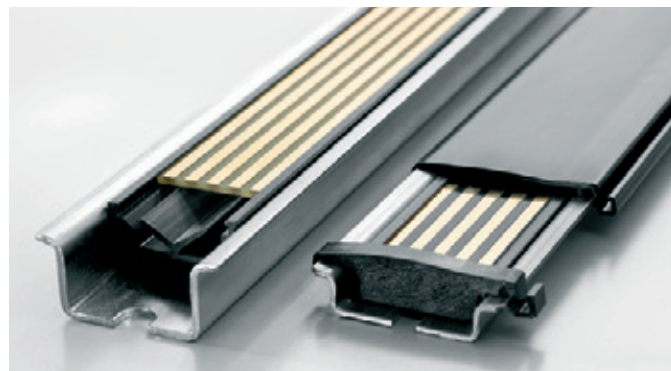

The resistant gold-plated contacts ensure a permanent and reliable contact. The ACT20M modules are simply snapped onto the mounting rail and are automatically in contact with the DIN rail bus.

The supply to the 24 V power supply can be from either one of the modules (up to 400 mA) or a separate power supply terminal (up to 4 A). This is sufficient for up to 120 modules. The ACT20-Feed-In-Basic provides a simple and compact (6 mm width) power supply terminal solution. The ACT20-Feed-In-Pro is a more powerful 22.5 mm wide solution. This makes a backup power supply that includes error messaging possible.



CH20M DIN rail bus

Rail bus accessories

CH20M BUS-PROFIL TS35x7.5/1000

Support section for bus circuit board



- Support section for TS 35 x 7.5
- Length: 250, 500 or 750 mm

Ordering data

Type	Qty.	Order No.
CH20M BUS-PROFIL TS35x7.5/250	10	1248150000
CH20M BUS-PROFIL TS35x7.5/500	10	1248160000
CH20M BUS-PROFIL TS35x7.5/750	5	1248170000

CH20M BUS-PROFIL TS35x15/1000

Support section for bus circuit board



- Support section for TS 35 x 15
- Length: 250, 500 or 750 mm

Ordering data

Type	Qty.	Order No.
CH20M BUS-PROFIL TS35x15/250	5	1248180000
CH20M BUS-PROFIL TS35x15/500	5	1248190000
CH20M BUS-PROFIL TS35x15/750	5	1248210000

CH20M BUS 4.50/05 AU/1000

Bus PCB



- Bus circuit board for use on TS 35 x 7.5 and TS 35 x 15
- Length: 250, 500 or 750 mm
- Five conductor paths, gold-plated
- Electrical rating: 63 V AC, 5 A/conductor path

Ordering data

Type	Qty.	Order No.
CH20M BUS 4.50/05 AU/250	10	1248220000
CH20M BUS 4.50/05 AU/500	10	1248230000
CH20M BUS 4.50/05 AU/750	5	1248240000

CH20M BUS-ADP TS35/1000

Cover plate



- Cover plate for DIN rail bus
- Length: 250, 500 or 750 mm

Ordering data

Type	Qty.	Order No.
CH20M BUS-ADP TS35/250	10	1248250000
CH20M BUS-ADP TS35/500	10	1248260000
CH20M BUS-ADP TS35/750	5	1248270000

CH20M BUS-AP LI TS35x7.5 & 15

End plate



- End plate for DIN rail bus
- Fits on TS 35 x 7.5 and TS 35 x 15
- left

Ordering data

Type	Qty.	Order No.
CH20M BUS-AP LI TS35x7.5 & 15	50	1193160000

CH20M BUS-AP RE TS35x7.5 & 15

End plate



- End plate for DIN rail bus
- Fits on TS 35 x 7.5 and TS 35 x 15
- right

Ordering data

Type	Qty.	Order No.
CH20M BUS-AP RE TS35x7.5 & 15	50	1193170000

SET CH20M BUS 250MM TS 35X15

Set

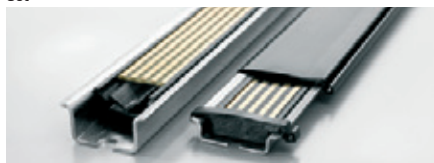

- SET consists of one each of
CH20M BUS 4.50/05 AU/250
CH20M BUS-ADP TS 35/250
CH20M BUS-AP LI TS 35X7.5 & 15
CH20M BUS-AP RE TS 35X7.5 & 15
CH20M BUS-PROFIL TS 35X15/250

Ordering data

Type	Qty.	Order No.
SET CH20M BUS 250MM TS 35X15	1	1335150000

SET CH20M BUS 250MM TS 35X7.5

Set

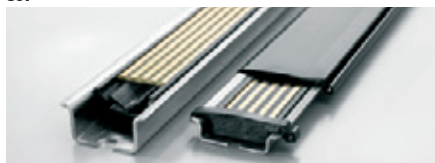

- SET consists of one each of
CH20M BUS 4.50/05 AU/250
CH20M BUS-ADP TS 35/250
CH20M BUS-AP LI TS 35X7.5 & 15
CH20M BUS-AP RE TS 35X7.5 & 15
CH20M BUS-PROFIL TS 35X7.5/250

Ordering data

Type	Qty.	Order No.
SET CH20M BUS 250MM TS 35X7.5	1	1335140000

TS 35x7.5 / TS 35x15

DIN rail

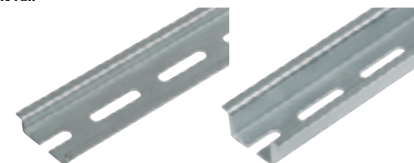

- DIN rail with slot
- Passivated galvanised steel

Ordering data

Type	Qty.	Order No.
TS 35x7.5/LL 1M/ST/ZN	10	0514510000
TS 35x15/LL 1M/ST/ZN	10	0236510000

Accessories
Analogue Signal Conditioning

G

ACT20 power-feed modules for rail bus

Power-feed module for the CH20M DIN rail bus

4 A supply with backup supply and error analysis

The power-feed unit ACT20-FEED-IN-PRO-S supplies the devices on the CH20M DIN rail bus with 24 V DC. At the same time, the FEED-IN device reads the group error contact – optionally provided by the installed devices – from the CH20M rail bus and sends a message through the status relay to the external controller. Optionally, two power supplies can be connected for the primary and secondary supplies (backup). An installation in Zone 2 / Division 2 is also possible. Three LEDs show the status of the power supply and the error status.



Weidmüller offers a compact and narrow 6 mm feed-in module as an alternative. This wires the terminal level directly to the DIN rail bus. Up to 80 modules can be fed with a maximum available current of 2.5 A.

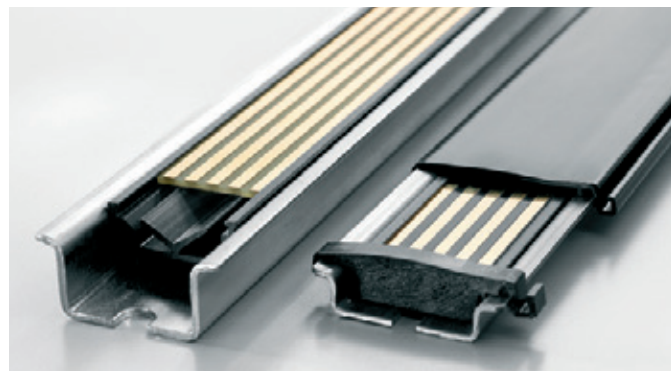

The FEED-IN-PRO can supply a maximum of 4 A to feed up to 120 devices mounted on a CH20M rail bus. Quick identification of errors on the DIN rail bus is through the internal status relay. The FEED-IN-PRO device immediately recognises and displays when a power supply has failed. The supply is then switched automatically to the redundant power supply.

ACT20 power-feed unit

ACT20 power-feed module

- Distributes the supply onto the busbar
- Compatible with Weidmüller CH20 DIN rail bus
- Optional connection for backup supply
- Approved for use in Ex-Zone 2 /Div. 2
- Monitoring of the supply voltage
- Alarm alerts via the status relay

ACT20-Feed-In-PRO-S

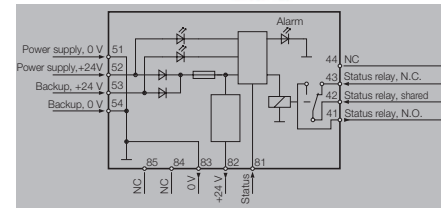

ACT20-Feed-In-BASIC-S

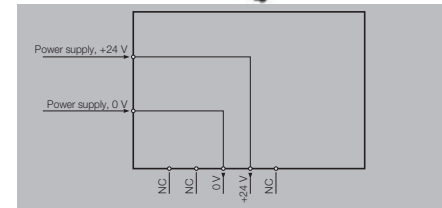

Accessories
Analogue Signal Conditioning

Technical data

Input	ACT20-Feed-In-PRO-S	ACT20-Feed-In-BASIC-S
Supply voltage	21.6...26.4 V DC	21.6...26.4 V DC
Input current	Max. 4 A	0.5...2.5 A DC
Trigger level for the power supply	21.6...26.4 V DC	
	Fault < 21 V DC	
Output, power supply		
Output voltage	Input voltage -0.5 V DC / 4 A	Corresponds to the input voltage
Output power	96 W	
Output current	Max. 4 A	Equivalent to input current
Output, status relay in safe zone		
Max. switching voltage, AC / Max. switching voltage, DC	250 V / 30 V	250 V / 30 V
Continuous current	2 A AC / DC	
AC power, max.	500 VA / 60 W	
General data		
Degree of efficiency	0,976	100 %
Ambient temperature		-20 °C...60 °C
Power consumption	< 2 W	
Protection degree	IP 20	IP 20
Weight	140	70
Humidity	95 %, no condensation	95 %, no condensation
Approvals	cULus; DEKRAATEX; DETNORVER; EAC; FMEX; GOSTME25; IECEXDEK	cULus; DETNORVER; EAC; FMEX; GI; GOSTME25; IECEXKEM; KEMAATEX

G

Dimensions	Screw connection	Screw connection
Clamping range (nominal / min. / max.)	2.5 / 0.5 / 2.5	2.5 / 0.5 / 2.5
Length x width x height	/ 22.5 / 117.2	/ 6.1 / 112.5
Note		

Ordering data

Type	Qty.	Order No.	Type	Qty.	Order No.
ACT20-FEED-IN-PRO-S	1	8965500000	ACT20-FEED-IN-BASIC-S	1	1282490000

Note		
------	--	--

Accessories

Note	DIN mounting rail, see Accessories	DIN mounting rail, see Accessories
------	------------------------------------	------------------------------------

ACT20X/ACT20C/ACT20P - Accessories

ACT20X/ACT20C/ACT20P



Connection terminals

Colour of housing	Release lever colour	Connection number	Printing	Type	Order No.			
black	blue	65/66/67/68	white	BHZ 5.00/04/90LH BK/BL PRT 65	1086480000			
		55/56/57/58	white	BHZ 5.00/04/90LH BK/BL PRT 55	1086470000			
		45/46/47/48	white	BHZ 5.00/04/90LH BK/BL PRT 45	1086460000			
		61/62/63/64	white	BHZ 5.00/04/90LH BK/BL PRT 61	1086420000			
		51/52/53/54	white	BHZ 5.00/04/90LH BK/BL PRT 51	1086410000			
		41/42/43/44	white	BHZ 5.00/04/90LH BK/BL PRT 41	1086400000			
	black	black	65/66/67/68	white	BHZ 5.00/04/90LH BK/BK PRT 65	1086240000		
			55/56/57/58	white	BHZ 5.00/04/90LH BK/BK PRT 55	1086230000		
			45/46/47/48	white	BHZ 5.00/04/90LH BK/BK PRT 45	1086220000		
			61/62/63/64	white	BHZ 5.00/04/90LH BK/BK PRT 61	1086180000		
			51/52/53/54	white	BHZ 5.00/04/90LH BK/BK PRT 51	1086170000		
			41/42/43/44	white	BHZ 5.00/04/90LH BK/BK PRT 41	1086160000		
			black	blue	35/36/37/38	white	BHZ 5.00/04/90LH BK/BL PRT 35	1086450000
					25/26/27/28	white	BHZ 5.00/04/90LH BK/BL PRT 25	1086440000
15/16/17/18	white	BHZ 5.00/04/90LH BK/BL PRT 15			1086430000			
31/32/33/34	white	BHZ 5.00/04/90LH BK/BL PRT 31			1086390000			
21/22/23/24	white	BHZ 5.00/04/90LH BK/BL PRT 21			1086380000			
11/12/13/14	white	BHZ 5.00/04/90LH BK/BL PRT 11			1086370000			
black	black	11/12		white	BHZ 5.00/02/90LH BK/BL PRT 11	1086250000		
		21/22		white	BHZ 5.00/02/90LH BK/BL PRT 21	1086260000		
		35/36/37/38		white	BHZ 5.00/04/90LH BK/BK PRT 35	1086210000		
		25/26/27/28		white	BHZ 5.00/04/90LH BK/BK PRT 25	1086200000		
		15/16/17/18		white	BHZ 5.00/04/90LH BK/BK PRT 15	1086190000		
		31/32/33/34		white	BHZ 5.00/04/90LH BK/BK PRT 31	1086150000		
		21/22/23/24		white	BHZ 5.00/04/90LH BK/BK PRT 21	1086140000		
		11/12/13/14		white	BHZ 5.00/04/90LH BK/BK PRT 11	1086130000		
41/42	white	BHZ 5.00/02/90LH BK/BK PRT 41	1086040000					

Cold-junction compensation terminals (optional for the ACT20X temperature modules)

1-channel	Release lever colour	Connection number	Printing	Order No.
black	blue	11/12/13/14	white	1160640000
2-channel				
black	blue	11/12/13/14	white	1160650000



Markers

Type	Version	Dimensions	Qty.	Order No.
ESG 66/20BHZ500/04	Individual markers	6.6 x 20 mm	200	1082540000
ESG 8/13,5/43,3 SAI AV	MultiCard (24 individual markers per MultiCard)	8 x 13.5 mm	5	1912130000

ACT20M



Ordering data markers

	Type	Qty.	Order No.
ACT20M marker	MS 5/7.5 MC NEUTRAL	320	1877680000
Note	The ACT20M voltage supply is cross-connected using the CH20M rail bus. Details are available on pages C.14 and G.6		

ACT20P



Ordering data markers

	Type	Order No.
ACT20P/X/C marker	ESG 8/13.5/43.3 SAI AU	1912130000
Note		

MCZ/WAVE - Accessories

Accessories MCZ



Ordering data end plates

Type	Qty.	Order No.
End plate	50	8389030000



Ordering data cross-connection

	No. of poles	Type	Qty.	Order No.
Plug-in cross-connection, yellow	2	ZQV 4N / 2 GE	20	1758250000
Plug-in cross-connection, yellow	3	ZQV 4N / 3 GE	20	1762630000
Plug-in cross-connection, yellow	4	ZQV 4N / 4 GE	20	1762620000
Plug-in cross-connection, yellow	10	ZQV 4N / 10 GE	20	1758260000



Ordering data markers

Type	Qty.	Order No.
Multicard connector marker	600	1828450000

WAVE Accessories



Ordering data cross-connection

	No. of poles	Type	Qty.	Order No.
Plug-in cross-connection, black	2	ZQV 2,5N/2 sw	60	1718080000
Plug-in cross-connection, red	2	ZQV 2,5N/2 rt	60	1717900000
Plug-in cross-connection, blue	2	ZQV 2,5N/2 bl	60	1717990000
Plug-in cross-connection, yellow	2	ZQV 2,5N/2 ge	60	1693800000



Ordering data markers

Type	Qty.	Order No.
Multicard connector marker	920	1635000000
Multicard connector marker	480	1609880000
Multicard connector marker	600	1828450000

Screw-connect connector strip for the WAVESERIES



3-pole

Type	Printing	Order No.
BLZ 5.08/3 SN OR BEDR.	1, 2, 3	2242030000
BLZ 5.08/3 SN OR BEDR.	4, 5, 6	2242050000
BLZ 5.08/3 SN OR BEDR.	7, 8, 9	2242060000
BLZ 5.08/3 SN OR BEDR.	10, 11, 12	2242070000

2-pole

Type	Printing	Order No.
BLZ 5.08/02/180 SN OR BX	without labelling	1526460000
BLZ 5.08/02/180 SN OR PRT	1, 2	2246070000
BLZ 5.08/02/180 SN OR PRT	3, 4	2246080000
BLZ 5.08/02/180 SN OR PRT	5, 6	2246090000
BLZ 5.08/02/180 SN OR PRT	7, 8	2246100000



Calibrators

Portacal 1000EU

Calibration device for current and voltage signals

The Portacal 1000EU is a calibration device which is controlled by a microprocessor. It is used for current and voltage signals. It has three output modes for simulating signals:

- **Voltage source:** for the simulation of externally-supplied voltage transmitters
- **Current source:** for the simulation of externally-supplied current sensors
- **Current sink mode:** simulates the outputs of a two-wire (loop-powered) transmitter.

Commonly used calibration functions can be invoked for each mode by pressing a button. Up to 9 storage locations per mode are available to save the individual values.

Furthermore, the Portacal 1000EU can be programmed in a way that all modes can be cycled automatically. The corresponding values are controlled continually for a pre-defined time by means of a value storage. The following values can be checked and parameterised:

- Voltage outputs
- Current outputs
- Two-wire transmitter outputs

The Portacal 1000EU provides the necessary voltage supply for the sensor in order to check a two-wire transmitter.

Technical features:

- Complete diagnosis tool for current and voltage supply
- Measuring and simulating of voltage and current signals
- Simulation of function of signal transmitter, which can be auxiliary-powered or process-powered (two-wire type)
- Continually adjustable step and ramping function
- Accuracy < 0.05 % in all signal domains
- Light and portable
- Supply via NiMH rechargeable battery or comparable battery
- Signal tone at the press of a button

Typical application of Portacal 1000EU

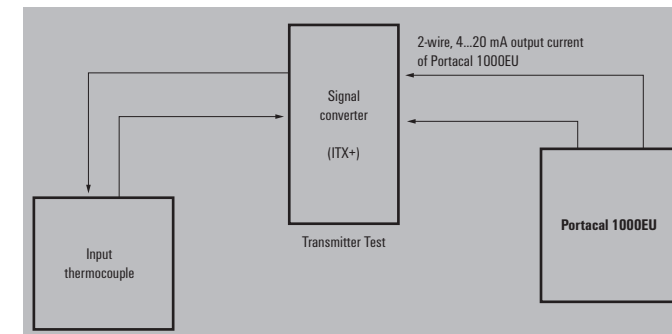

PORTACAL 1000EU

Instrument Calibrator

Technical data

Output voltage mode	
Output voltage	0...13 V
Resolution	0.01 V
Load current	0...10 mA
Accuracy	±5 mV
Residual ripple	< 1 mV
Internal storage	Nine user-defined voltages
Output current mode	
Output current	0...26 mA
Resolution	0.01 mA
Load resistance	600 Ω @ 20 mA (power source) 100 Ω (current sink)
max. input voltage current sink	9...45 V DC
Accuracy	±5 µA
Residual ripple	< 1 µA
Internal storage	Nine user-defined currents
Input voltage mode	
Input voltage	0...13 V
Input resistance	200 kΩ
Accuracy	±5 µA or ±1 digital step
Input current mode	
Input current	0...26 mA
Input resistance	47 Ω
Accuracy	±5 µA or ±1 digital step
Loop powered mode	
Type	Mode for loop-powered signal-converters
Input current	0...26 mA
Feed voltage	16 V ±10 %
Accuracy	±5 µA or ±1 digital step
Auto step/ramp mode	
Step	Output of each value within a certain time period
Ramp	Output via a programmed ramp function
Number of recorded values	2...9
Time interval	10...4200 s
Display	
Type	Four-digit display with LCD, 12 mm
Status indicator	Five LEDs for output mode, signal amplification and reduction
Display value	Percent or real-value displayed
Keyboard	
Type	16 buttons with acoustic signal
Calibration	Adjustable fixed values: 0, 2, 4, 8, 10, 12, 16, 18, 20 mA 0, 1, 2, 4, 5, 6, 8, 9, 10 V Nine freely-definable values 1 / 0.1 / 0.01 mA or V
Memory	
Decimals	
General data	
Supply voltage	Battery, 4x type „AA“
Temperature coefficient	< 0.01 % / °C at 100 %
Ambient temperature (operational)/storage temperature	0 °C...60 °C / -25 °C...+70 °C
Type of connection	Sockets
EMC standard	DIN EN 61326
Approvals	CE, cULus
Dimensions	
Length x width x height	44 x 100 x 180 mm
Note	

Ordering data

Type	Qty.	Order No.
PORTACAL 1000EU	1	1439640000
2 x 1 m test cable sw/rt with banana plug/terminal		

Accessories

Note	
-------------	--

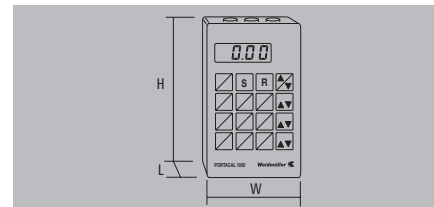

G

Portacal 275

Hand-held signal source and loop calibrator

The Portacal 275 is a precise hand-held signal source for current and voltage signals. It can be used in four modes which allows the calibration of standard current/voltage transmitters.

The operating mode "voltage source" simulates auxiliary-powered transmitters with proportional voltage outputs. The mode "current source" allows emulation of transmitters with proportional current outputs. The "mv source" mode simulates a variety of other analogue signals from many different applications. The "current sink" mode simulates the outputs of a two-wire (loop powered) transmitter.

The Portacal 275 is equipped with a scalable potentiometer (0 to 100 %) that can be adjusted in steps to an accuracy of 0.1 %. Together with the output-range switch, the potentiometer allows for a quick and precise adjustment of the signal value. A typical accuracy of ± 0.25 % is possible. An integrated test point, for connecting external measurement devices, allows for a higher accuracy of ± 0.1 %.

Technical features:

- Light and portable device
- Simulates loop-powered transmitter operation
- LED for indication of source/sink operating mode
- Current ranges: 0 to 20 mA / 4 to 20 mA / Voltage ranges: 0 to 5 V / 1 to 5 V / 0 to 200 mV
- 0.1 % accurate current source
- Test points for current output monitoring
- Switch select 0 %, 100 % or variable output
- Signal outputs can be adjusted with spindle potentiometer for high accuracy
- Powered from two 9 V block batteries

Portacal 275

Calibration device for current and voltage signals

Portacal 275

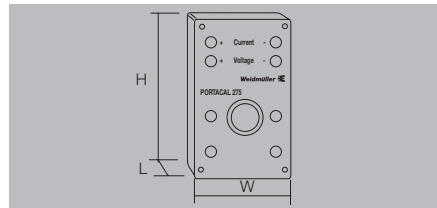

Technical data

Output of voltage mode

Output voltage
Resolution
Output resistance
Accuracy

0...5 V / 1...5 V; 0...200 mV / 40...200 mV
0.01 V
250 Ω @ V / 10 Ω @ mV
< 0.2% (0% and 100%)

Output current mode

Output current
Resolution
Last resistor, max.

0...20 mA
0.01 mA
700 Ω (current source)
(V_{out} - 4) / 0.02 Ω (current sink)

Output voltage, max. @ current sink
Accuracy
Residual ripple

4...45 V DC
< 0.1% (0% and 100%)
< 1 μA

Settings

Range of adjustment

0...20 mA / 0...200 mA (current source), 0...5 V (voltage source) or as current sink selectable with toggle switch

Output, variable
Output, fixed

0...100 % with precision potentiometer
0 or 100 % with toggle switch

General data

Temperature coefficient
Accuracy
Supply voltage

Ambient temperature
Storage temperature
Type of connection
EMC standards
Approvals

typ. 40 ppm @ °C
0.25 % of signal range
Batteries, 2 x 9-V blocks 6...22 mA (current source)
2 mA (current sink)
0 °C...60 °C
-25 °C...70 °C
Socket
DIN EN 61326
CE; cULus; EAC

Dimensions

Length x width x height

31 / 62 / 112

Note

Including two one-metre-long test leads sw/rt with banana plug/terminal and one bridge lead

Ordering data

Type	Qty.	Order No.
P275	1	7940010202

Note

Accessories

Note

Wiring diagram

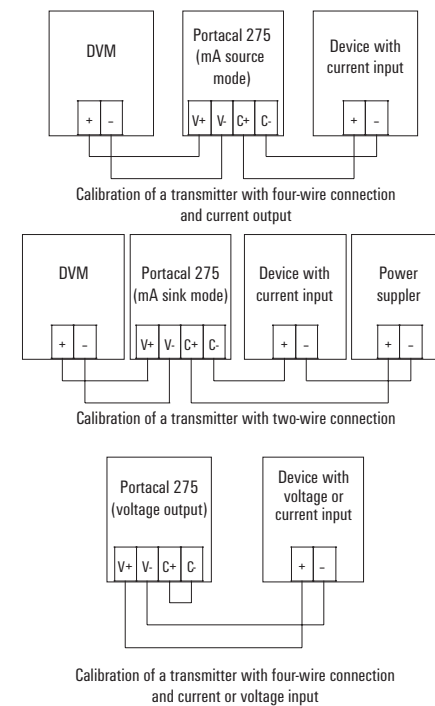

G

Technical appendix/Glossary

Technical appendix/Glossary	Dimensioned drawings	W.2
	Introduction	W.4
	Technical data	W.6
	FDT/DTM - The standard solution for device configuration	W.10
	EX basics	W.12
	ATEX	W.18
	Electrical data	W.20
	General technical information	W.22
	Glossary	W.23

Dimensioned drawings

ACT20M - Dimensioned drawings

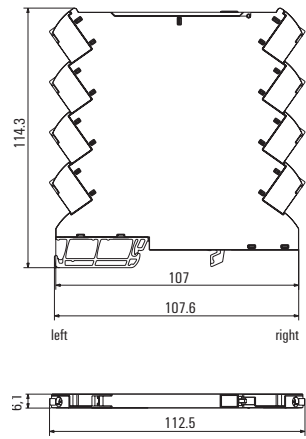

MICROSERIES

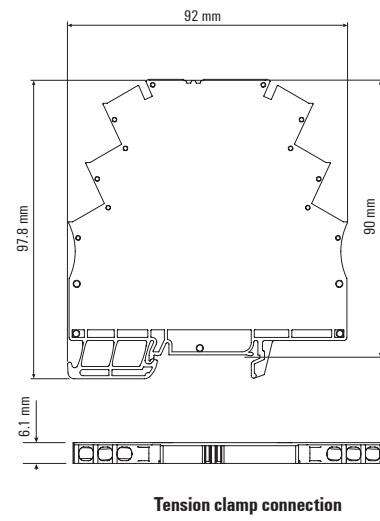
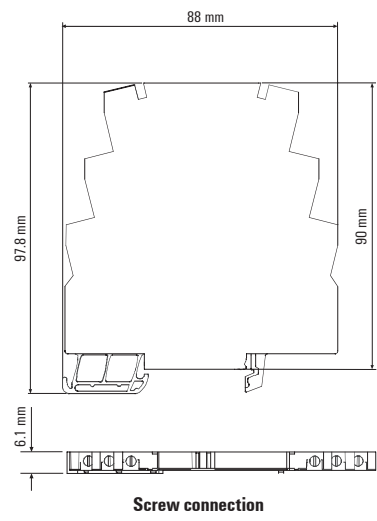

ACT20X/ACT20C/ACT20P

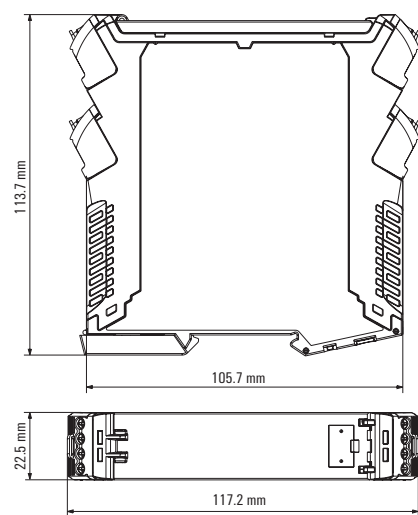

ACT20X HUI-SA0-LP-S

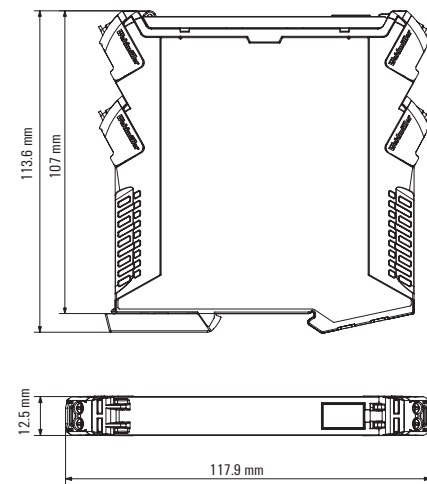

Dimensioned drawings

WAVEBOX S 22,5

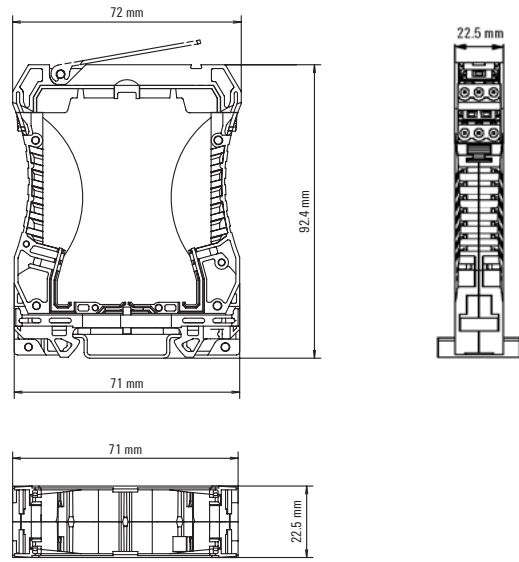

WAVEBOX L 22,5

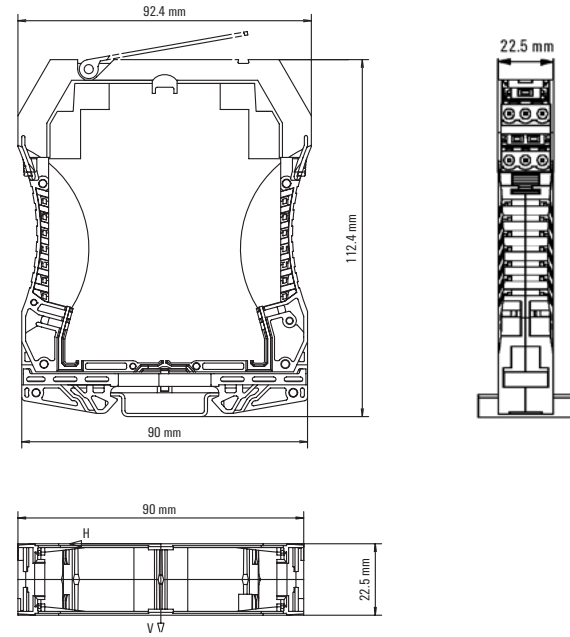

WAVEBOX 12,5

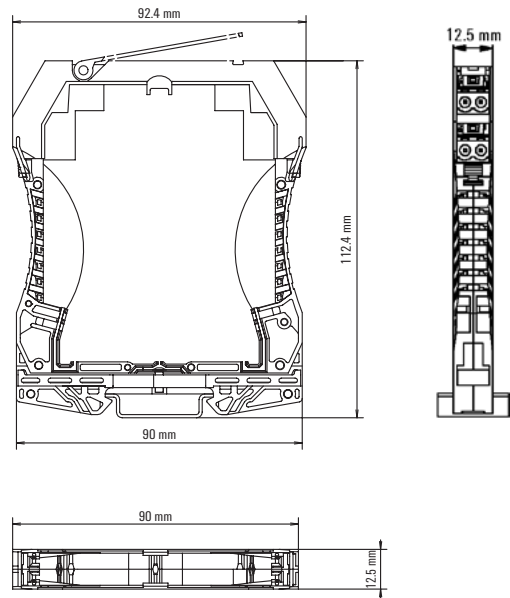

WAVEBOX 17,5

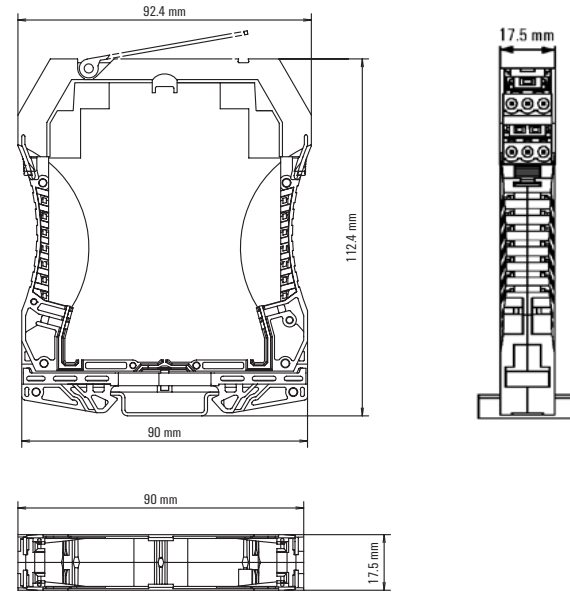

Technical appendix/Glossary

W

Different types of analogue signalling

The working environment can be measured in many different forms, e.g. in terms of temperature, humidity or air pressure. The values of these physical variables change constantly. Components that monitor the status and changes of a given environment and provide alerts of any changes must be able to continuously display the changes taking place.

In industrial and process automation, the outputs received from field sensors, switches and transmitters provides measurement and status data which becomes the analogue and digital inputs (AI and DI) for the control system. Similarly, control signals are passed from the control system to field control equipment such as analog and digital valves and actuators.

If automation processes are expected to reach certain statuses or keep them constant, then analogue signal conditioning is required. It is also important in areas where this has already been part of long established practice, e. g. in process engineering or the chemicals industry.

In process engineering, standardised electrical signals are normally used. Currents of 0 ... 20 mA, 4 ... 20 mA or voltages of 0 ... 10 V have become established as the output variables for sensors recording various different physical parameters.

Weidmüller takes account of the growing preference for automation – including and the resulting need for analogue signal conditioning – and offers a wide range of products tailor-made to the requirements involved in handling sensor signals. Units for the common signals (0 ... 20 mA, 4 ... 20 mA, 0 ... 10 V) generate an output signal as a proportional value of the variable input signal. "Protective separation", e.g. of the sensor circuit from the evaluation circuit, is also taken into account. "Protective separation" prevents mutual interference among several sensor circuits, e.g. as in the case of earth loops in interlinked measuring circuits.

The wide range of Weidmüller products completely covers the functions involved in signal conversion, signal separation and signal monitoring. The products can thus handle nearly all applications in industrial measuring technology, and safeguard elementary functions between field signals and further processing systems. The mechanical properties of the products are built up around a consistent concept.

Signal converters can be used with other Weidmüller products and combined with each other. They are designed to entail a minimum wiring workload and maintenance in both electrical and mechanical terms.

The product range contains the following functions:

- DC/DC converters
- Current converters
- Voltage converters
- Temperature converters for resistance thermometers (RTDs) and thermocouples
- Frequency converters
- Potentiometer transducers
- AC transducers
- Bridge transducers (strain gauges)
- Threshold monitoring modules
- AD/DA converters

The products are available as pure signal converters, or with 2-port or 3-port isolation and a choice of passive or output loop powered or auxiliary powered, depending on the application requirements.

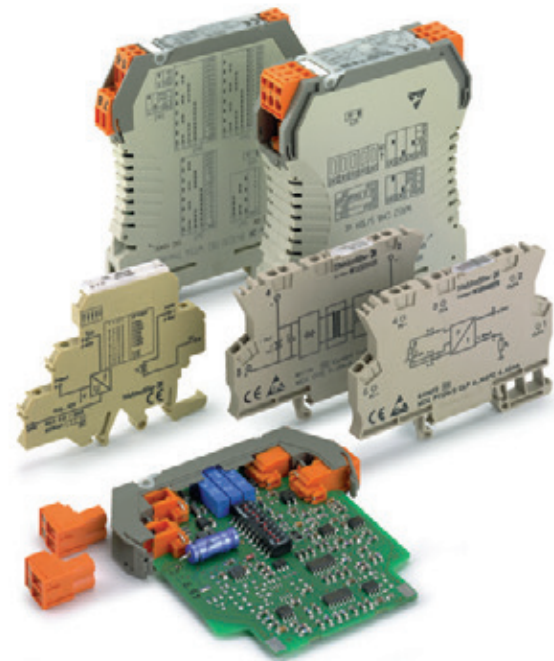

2-way isolation separates the signals from each other electrically and decouples the measuring circuits. Potential differences – caused by long line lengths and common reference points – are eliminated. Furthermore, the electrical separation protects against irreparable damage caused by overvoltages as well as inductive and capacitive interference.

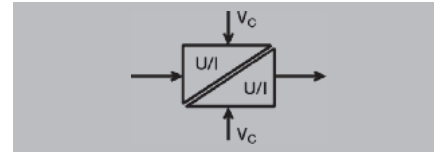

3-way isolation decouples the supply voltage from the input and output circuits as well and enables the function to operate with just one operating voltage.

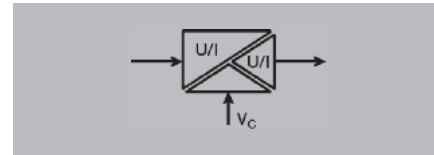

The **passive separator** offers an extra, decisive advantage – it requires no additional voltage supply. The power supply to the module is achieved via the input or output circuit and is transmitted to the input/output. This current loop feed is characterised by a very low consumption.

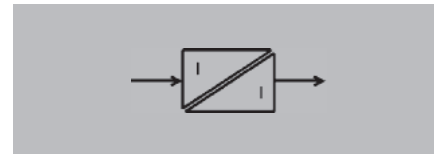

A number of products are available for temperature measurements. For example, **PT100** signals in 2-, 3- and 4-wire systems are converted into standard 0...20 mA, 4...20 mA and 0...10 V signals.

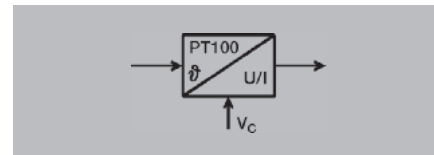

The modules for connecting conventional **thermoelements** are fitted with cold trap compensation as standard. Furthermore, they amplify and linearise the voltage signal provided by the thermocouple. This guarantees accurate analogue signal conditioning while eliminating sources of interference or error.

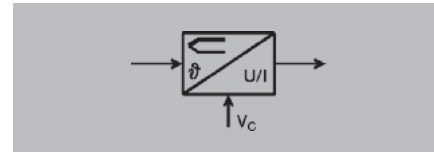

Frequency converters convert frequencies into standard analogue signals. Downstream controls can therefore directly process pulse strings for measuring rpm or speed.

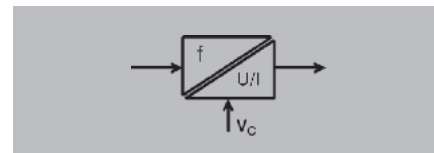

AD or DA converters are required for bringing together the analogue signal forms mapping the local conditions and the digital processing in the process monitoring system. Weidmüller can supply such components for the customary 0...20 mA, 4...20 mA and 0...10 V input and output signals. 8-bit processors are available on the digital side.

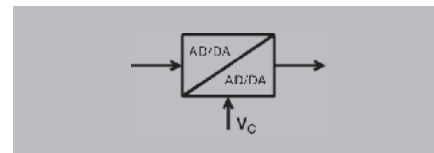

Current-monitoring modules can be used to control DC and AC currents up to 60 amps. A switching operation is triggered when the set current values are not met or exceeded. Components with analogue outputs monitor the current load continuously via downstream controls.

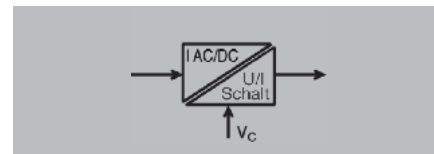

Voltage monitoring modules can be used to monitor AC and DC voltages. Adjustable switching thresholds can be used to reliably detect and notify in the event of fluctuations caused by switching operations or mains overloads.

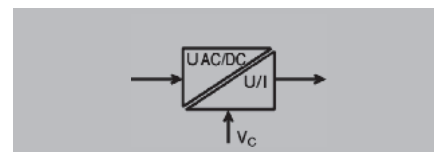

Technical data



Common Mode Noise Elimination

- Generally, signals emitted by sensors have low levels and are thus susceptible to capacitive and inductive interference, such as those generated by motors, frequency changers and other change processes. This noise contents the measuring value and frequently destroys expensive analog I/O cards in the control electronics. Through the utilisation of analogue signal isolators this interference, which usually actions both signal lines in common mode (push push), is effectively eliminated through the zero potential input.

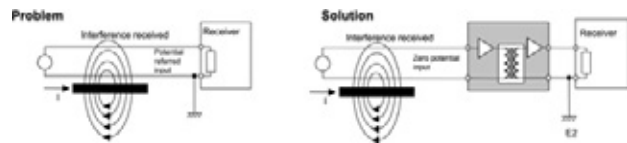

Active Isolator / Passive Isolator

- Active isolators draw their power supply from a separate supply terminal to ensure that they can operate perfectly. Depending upon the applications the input, output and additionally the power supply are isolated from each other. Only one supply is required for 3-port isolation. However, it is isolated from the input and output circuits. Thus even in the event of a short circuit, surge voltage or reverse polarity, the downstream control electronics cannot be damaged. Isolating the signals between the input and output can be conducted either optically or by transformer barrier depending upon the transfer rate. Active isolators are non interacting, i.e. a change in the load does not exert any influence on an input circuit.
- Passive isolators generate the current required for the supply from the measuring signal. The current required internally is so small that transfer problems do not occur here.
- The feed can be effected from either the input or the output side. Isolation is by transformer barrier. The advan-

tages are: cessation of network influences, outstanding accuracy, low signal delay and low potential requirement. Passive isolators are not non interacting; a change in load in the output circuit will influence the input circuit.

Ground Loops

- The voltage supply's secondary side is earthed for the purpose of setting up fast and secure ground loop monitoring. If an analogue signal is fed in from a separate voltage supply or if the sensing device itself is earthed, then transient currents will flow between the ground potentials across the interconnected ground connectors, which in turn corrupts the measuring signal. Analogue signal isolating amplifiers prevent this form of measuring signal corruption and influence.

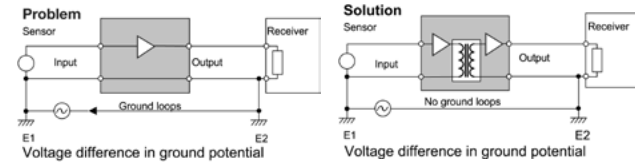

2-port Isolation

- The simplest form of analogue signal isolator is that of 2-port isolation. It serves to isolate the input circuit from the output circuit as well as the two auxiliary voltages from each other. Depending upon the isolator design and the observed isolation data one refers here to base isolation (galvanic isolation) or safe separation. ① For current signals, 4...20 mA input current loop fed modules are available. An additional auxiliary voltage for the input circuit is not required here. ② By connecting the input and output side voltage supplies, the 2-port isolation can be converted to operate as a simple signal converter. This is of particular interest where isolation is not required for an application, but a signal conversion has to be performed.

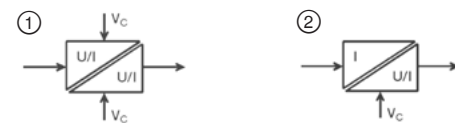

3-port Isolation

- 3-port isolation is the most universal form of signal isolator
- An optical coupler or transformer isolates the input from the output circuit. Together with the clearance and creepage distances it serves to define the isolation level. For example, the input signal is converted by means of pulse-width modulation into a frequency signal and demodulated again on the output side to form an analogue value. An amplifier then generates a standardised analogue signal. A galvanic isolated DC/DC converter feeds the input and output circuit with a potential free supply voltage. It also determines the isolation level through its data, air and creepage distances. In the case of these three isolation paths (input/output, input/auxiliary voltage, output/auxiliary voltage) one refers to 3-port isolation.

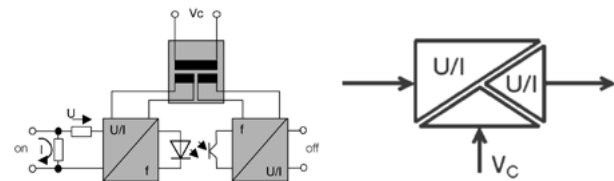

Temperature Signal Measuring Method

- Measurement using resistors (RTD)
When measuring with temperature-dependent resistors a current of approx. 1.5 mA is passed through the resistor from a constant current source in the signal converter.

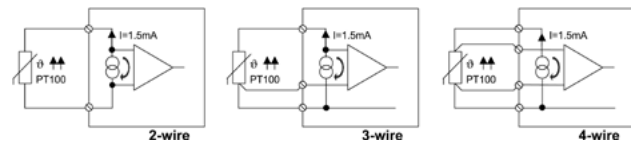

An operational amplifier is used to measure the potential drop at the resistor (2-wire circuit). In order to take account of lead length, the voltage drop is measured at the return conductor and calculated with double the value (3-wire circuit). This simulates the wire resistances from the feed and return lines. Accurate measurements are achieved by separately measuring the voltage drop at the feed and return lines (4-wire circuit). The values for the supply lines are calculated against the measured value.

Temperature Signal Measuring Method

- Measurements using thermocouples
When conducting measurements using thermocouples the voltage that is generated when two differently alloyed metals come into contact with each other is measured. A differential amplifier is then used to recondition the signal. The easiest (and the most cost-effective) method of subsequent processing is conducted by means of an amplifier circuit, which converts these signals into standard signals. High-end components process the measuring signal using a microprocessor, which simultaneously reconditions the signal (filtering, linearisation)

Cold Junction Compensation For Thermocouples

- Recording temperatures by using thermocouples encounters the problem of a thermal voltage forming at the clamping terminals on the signal converter on account of the different materials in the conductors and bus bar. This voltage then counteracts the thermal element's voltage.

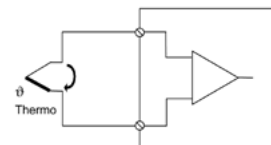

In order to compensate for the error to the measured value which arises here, the temperature is measured at the clamping terminal. The microprocessor in the signal converter reads the value measured there and calculates it against the measured value. This procedure is known as cold junction compensation.

$$\frac{\text{Voltage at the measuring point } (V_{\text{meas}}) + \text{Voltage at the terminal } (V_{\text{terminal}})}{= \text{Voltage at the thermocouple } (V_{\text{thermo}})} \Rightarrow \text{Temperature at the thermocouple } (T_{\text{thermo}})$$

Linearisation

- Temperature-dependent components do not normally have linear characteristic curves. To ensure that further processing can take place with the necessary accuracy, these characteristic curves have to be linearised to some extent. The graph showing measurements of thermocouples, in particular, reveals significant deviations at some points from the "ideal graph". As a consequence, the signal which has been measured is worked up by microprocessor.

W

Technical data

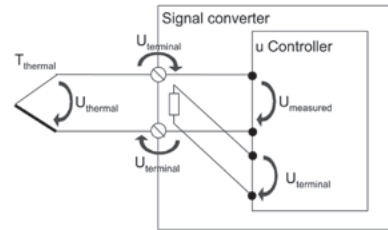

The microprocessor compares the value measured with the characteristic curve for the thermocouple in its memory and calculates the corresponding value on the "ideal characteristic curve". At the output, it supplies the latter to an amplifier, which produces the analogue value in linear form. The output stage converts this into a standardised value or into a switching output with a switching threshold.

The linearisation of PT100-elements can be undertaken via simple amplifier stages. The first stage corrects the peak value of the graph of the measurements. The deviation at the end of the graph resulting from this is corrected by a second stage. The under- and overshooting generated in this way is very slight and is covered by the tolerance for the module.

The secondary winding supplies the measuring electronics with a proportional current signal. Because of power loss this method of measuring current is limited to smaller currents up to 5 A. These converters react sensitively to peak loads and therefore have to be fused on the primary winding side.

Measuring Current Using A Hall-type Sensor

- Hall-type sensor principle: Hall-type sensors also measure the magnetic flux B and supply a proportional voltage at the measured output, which is then reconditioned to form a standard signal by an amplifier circuit.
- Components with Hall-type sensors are ideally suited to measuring higher currents, as any possible high residual currents from motors or peak loads cannot damage the component. Additionally, they are also ideal for measuring direct and alternating currents of various curve shapes.

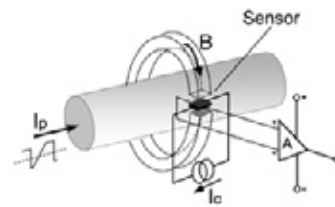

Current Measurement Using A Measuring Transformer

- Transformer principle: Each conductor through which current flows is surrounded by a magnetic field H, the intensity of which is proportional to the current. The field, which is bundled in a magnetic core, generates a magnetic flux B, through which suitable sensors are used to measure current.

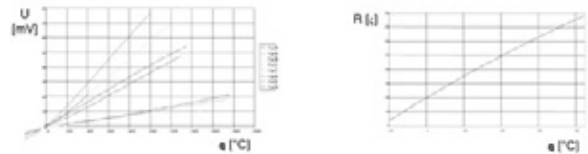

Converters with transformer-type couplings are used to establish the most cost effective measurement method for simple sinusoidal currents. The current to be measured flows directly through the measuring transformer's primary winding.

Root Mean Square Measurement / Crest Factor

- The root mean square value (r.m.s) of a sinusoidal shaped alternating current is the value, which in an ohmic resistor converts the same (effective) output as that of an equal sized direct current.
- Non sinusoidal shaped signals can only be measured with "True RMS" capable devices and/or further processed.
- True RMS = True root mean square
- Root mean square measurement is required where the (effective) output content of alternating voltages or currents are to be measured or evaluated.
- The crest factor indicates the ratio of the crest factor to the root mean square value.

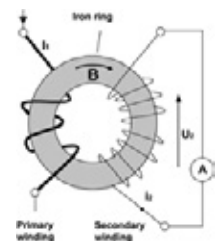

Load / Load Resistor

- The load is a load resistor on the output side of a measuring transducer or isolating amplifier. The load is usually less than 500 Ω at the current outputs. Voltage outputs are normally under a load greater than 1 KΩ.

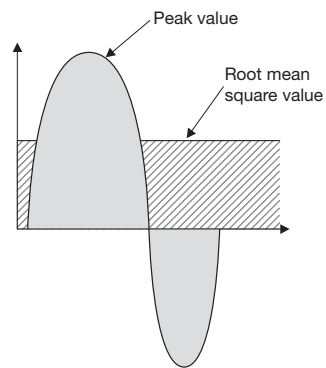

Galvanic Isolation / Safe Separation

- Galvanic isolation is understood to mean an electrical isolation between the input and output circuit and the circuit's supply voltage. It can be set up either optically using an opto coupler or with a transformer. The isolation serves to safeguard the measuring circuit against damage and to eliminate ground loops, which could cause the measured signal to be corrupted.
- Safe separation is specified under the German DIN VDE 0106 Section 101 standard. This fundamental safety standard is intended to safeguard persons against hazardous body currents and describes the basic requirements for safe separation in electrical operating equipment. Thus, for instance, the voltage supply of 50 V AC/ 75 V DC as under 50178 may not be exceeded. If this voltage is exceeded a reinforced or double insulated and thus an increase in the clearance and creepage distances is stipulated.

Cut-off Frequency

- Cut-off frequencies indicate the dynamic transfer characteristic of an isolation amplifier.
- The given frequency is the (-3dB-) limit, at which a distinct change occurs to the signal.
- An increased cut-off frequency leads to a transmission of higher-frequency alternating components, which corrupts the required signal.

Hysteresis

- Hysteresis indicates the percentage difference between the input and output points of a switching contact. It should not be lower than a given minimum value, as otherwise a specified chase can no longer be implemented.

Broken-wire Detection

- When measuring transformers with broken wire detection the input signal is monitored permanently. In the event of a fault (broken wire) the output signal exceeds its rated range. The downstream control circuit can then analyse the fault case.

Response Time

- Response time refers to the change in output signal for an input signal jump (10 ... 90 %). It is directly related to the cut-off frequency (inversely proportional).

Accuracy / Temperature Coefficient

- Accuracy describes the capability of a measuring device to deliver a measured value as accurately as possible. It relates to the end value and is given for ambient temperature (23 °C). Example:
An RTD is given with an accuracy of 1 %. The measuring range is set to 0 – 200 °C. The expected effective error of: $200 \cdot 1 \% = \pm 2K$ applies across the entire measurement range.
- Temperature coefficient describes the deviations in accuracy of the measuring devices dependent on the ambient temperature. It is given as a % or in parts per million / Kelvin (ppm /K). Example:
An RTD with an accuracy of 1 % and a measuring range of 0 – 200 °C has a temperature coefficient of 250 ppm / K. If the device is operated at +40 °C, it will then contribute the following to an expected absolute error: $(([40 \text{ °C} - 23 \text{ °C}] \cdot 250 \text{ ppm/K}) + 1 \%) \cdot 200K = \pm 2,85K$ across the entire measurement range.

FDT/DTM – The standard solution for device configuration

Field Device Tool (FDT)

FDT technology specifies and standardises the integration of communicating devices from different manufacturers. It makes use of a superimposed device management program. The key feature is its independence from the communication protocol and software used by the device and the host system. FDT allows access to any device from any host using any protocol.

Device Type Manager (DTM)

Device manufacturers make available a Device Type Manager (DTM) software driver for each device or device group. The DTM specifies all device-specific information, functions and rules (such as the device structure, communication capabilities, internal dependencies and the human-machine interface (HMI)). DTMs define functions for access to device parameters, troubleshooting, configuration and operation of devices. DTMs are available which can be simple GUIs for setting device parameters or more complex applications that are capable of carrying out calculations for diagnostic or maintenance purposes.

There are several different types of DTMs:

- **Device DTM**
This is a “normal” field device that uses communication channels to communicate with the connected physical device.
- **Communication DTM**
This is a communications device that provides communication using communication channels. Communication channels provide access to the communications infrastructure (such as PC interface cards or modems). They are used by device DTMs or gateway DTMs for communication services.
- **Gateway DTM**
This is a gateway device. It allows data to be exchanged between two communication channels. For example, this could be a gateway between PROFIBUS-DP and PROFIBUS-PA.

The DTM is loaded and started up within a FDT container program or “frame” application.



FDT frame application

Frame applications can be used as a tool to configure devices, plan projects, operate consoles or administer facilities. The FDT frame application provides a PC software environment with the following functions:

- User administration
- DTM administration
- Data management
- Network configuration
- Navigation

Weidmüller offers their WI-Manager FDT frame program to the user for no cost. This certified software is compatible and works together with all certified DTMs. This screenshot shows the WI-Manager with an opened DTM for the ACT20X series.

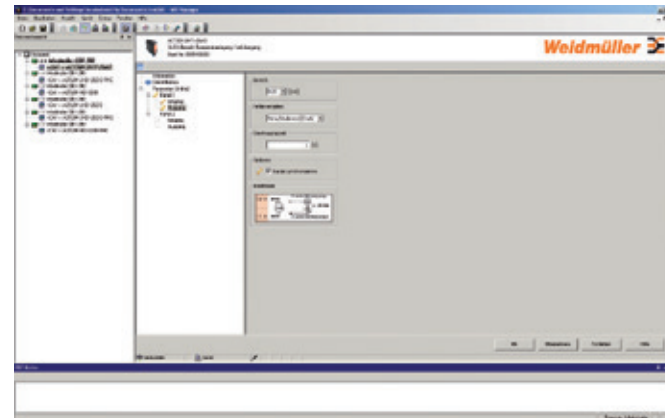

Download at www.weidmueller.com/



FDT User Group

The FDT User Group is an alliance of users and manufacturers interested in defining the specifications and moving the FDT/DTM technology forward. Weidmüller is a member of this group along with most process automation manufacturers and work towards advancing this standard further.

More details are available at <http://www.fdtgroup.org/>

Safety in hazardous areas

When operating electrical devices within hazardous areas, you must comply with the requirements regulating their use in such zones. Explosive atmospheres may be created from mixtures of flammable gases, mists, vapours or dusts. If their concentration is high enough in the surrounding air, any source of ignition or spark could trigger an explosion. Such explosions can cause death, serious injuries and significant property damages.

There are basically two strategies for reducing the risk of explosion. Firstly, no dangerous materials should be released into the air that could create an explosive atmosphere. Secondly, there should be no mechanism present that could create a spark.

Many explosions in the past could have been avoided if only the international regulation governing the use of equipment in hazardous areas had been observed.

But what are the most important global regulations regarding the use of devices in hazardous areas?

In North America, the US National Electric Code (NEC) regulations (Articles 500 to 505 and the Canadian CEC (Canadian Electrical Code) Articles 18-000, -090, -100, -200 and -300 are all valid.

In Europe, both EU directives ATEX 95 (94/9/EG) and ATEX 137 (1992/92/EC) are relevant. They describe preparation (ATEX 95) and usage (ATEX 137) for facilities in potential Ex zones. Throughout the rest of the world, there is a mixture of national regulations (in Eastern Europe) and international IECEx conformity declarations (in Asia) that must be followed. In certain Asian countries, the European ATEX directives have been accepted and applied.

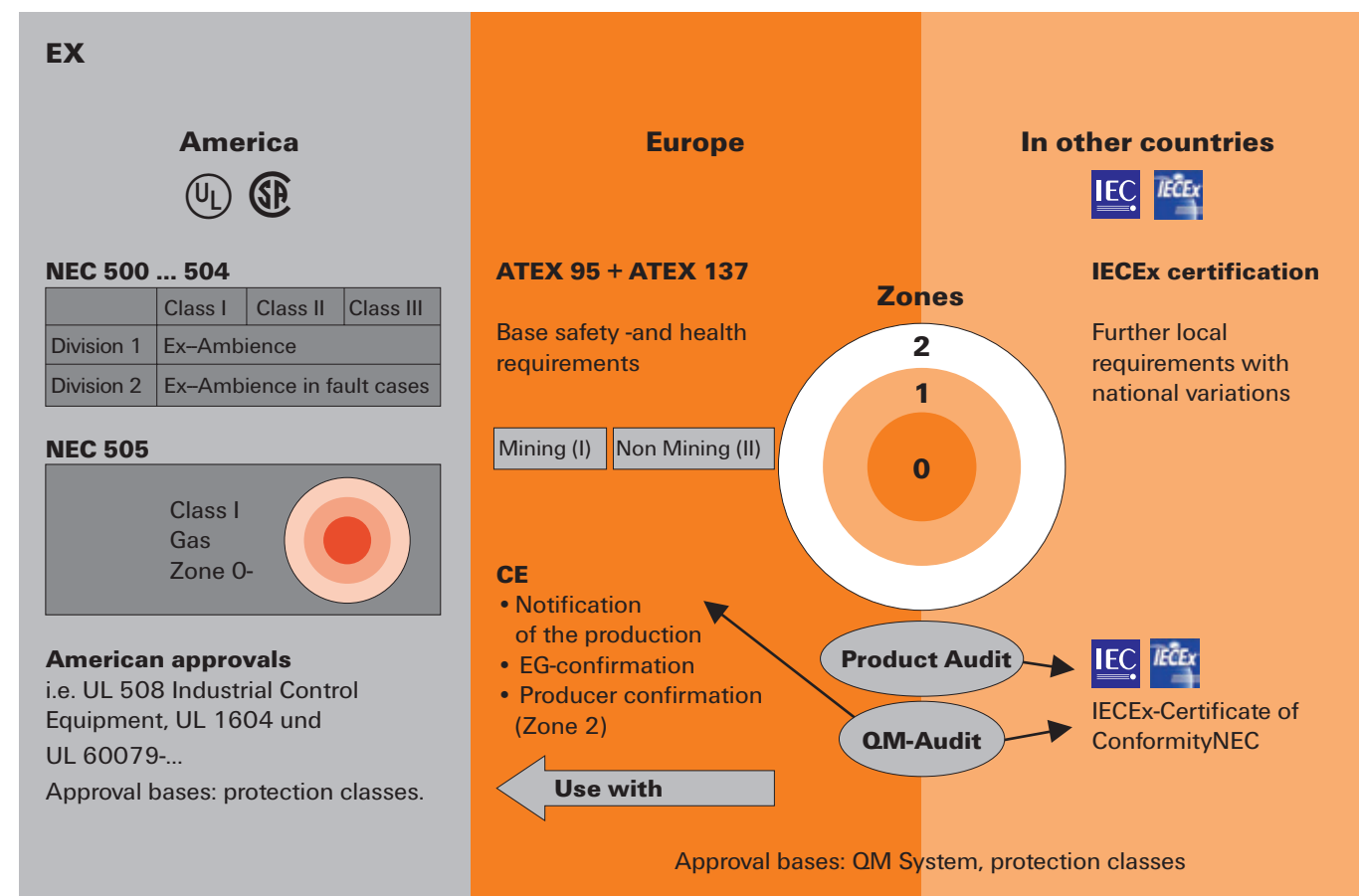

A brief overview of regulations used throughout the world and their basic content.

The European ATEX Regulation applies to facilities and their usage in hazardous areas.

The term "ATEX" derives from the French phrase "Atmosphères Explosive". The regulation currently includes two directives from the European Union concerning explosion protection. These are the ATEX operational directive 1999/92/EG (ATEX 137) and the ATEX product directive 94/9/EG (ATEX 95). The ATEX 137 operational directive specifies the minimum requirements for improving the protection of health and security of workers in environments at risk of explosions. The ATEX 95 product directive specifies the rules for introducing products on the market that will be used in zones where there is risk of explosion. This directive is the first to include non-electric devices within its jurisdiction.

The purpose of the directive is to protect personnel who work in hazardous areas. Appendix II of the directive contains the basic health and safety requirements. These must be followed by the manufacturer and compliance must be proven by declarations of conformity. Since June 30, 2003, all devices, components and protective systems brought to the market must be in compliance with the ATEX 95 product directive.

The ATEX 95 directive classifies devices and components for the Ex zone into two main groups:

Group I

- => Devices for use in mining, for underground and above-ground operations
 - Coal dust
 - Methane
 - Harsh operating conditions

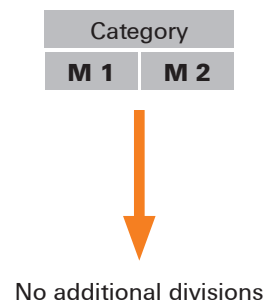

Group II

- => Devices for use in the other hazardous areas

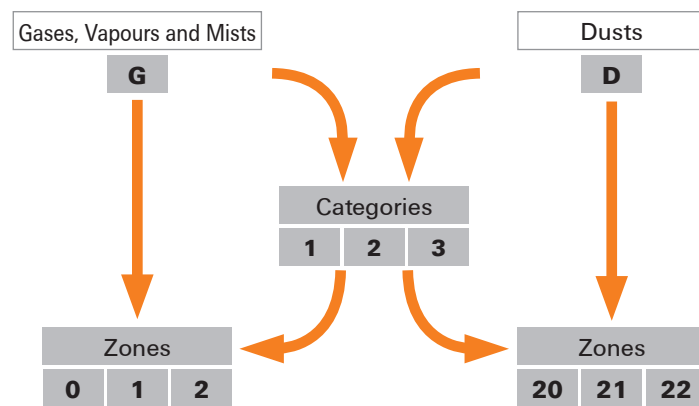

For applications in the oil, gas and chemical industries, it is particularly important to follow the Group-II "G" requirements concerning electrical or electronic devices and components.

W

Safety in hazardous areas

Group II "G" divides the Ex zone into three zones with different safety requirements.

- Zone 0** This zone applies to dangerous explosive atmospheres where the risk is present often or over long time periods.
 => > 50 % of the operational time, or more than 1.000 hours per year.
- Zone 1** This zone applies to situation where explosive atmospheres may occasionally be present during normal operations.
 => Occasionally, less than 10 hours per year.
- Zone 2** This zone applies to situation where explosive atmospheres are normally not present or only briefly present during normal operations.
 => Max. 30 min/year.

Hazardous areas

	Zone 0	Zone 1	Zone 2	Safe zone
Explosion risk	Continual, long-term, often	Occasionally	Rarely	None
Spark source	None	Rarely and short-term	Occasionally	Continual, long-term, often

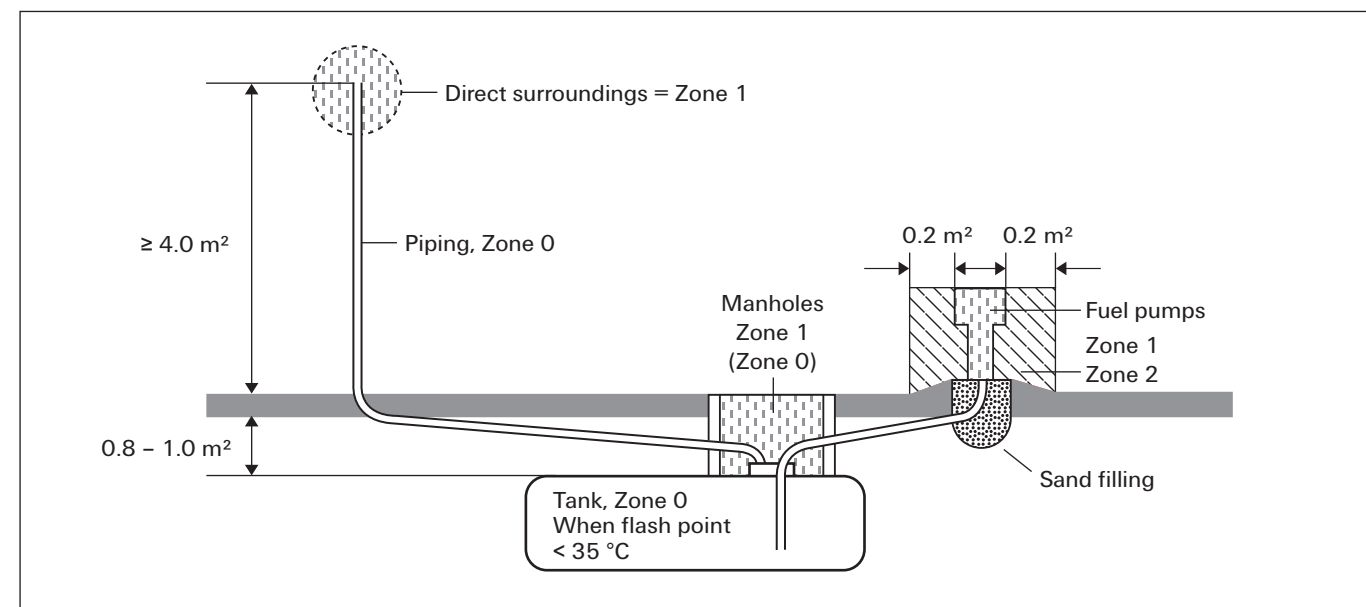

Typical division of zones at a fuelling station

In which operations are ATEX-certified electronic devices (such as signal converters, isolation amplifier, Namur switches and switching amplifiers) used?

ATEX-certified devices are used within industrial facilities and production halls where there is the possibility that explosive gases or dusts may be released.

Transportation and production applications which require the use of such certified devices are listed below:

- Off-shore oil and gas drilling
- Tanker ships which carry oil, gas or chemicals
- Ships which carry potentially explosive materials
- Refineries and other oil or gas production plants
- Transportation and filling stations for oil and gas
- Petro-chemicals

What are the differences between standard devices and intrinsically safe devices?

For electronic devices that are being used in Zone 0(20) or 1(21), none of the components or electrical circuitry are permitted to generate unallowable high temperatures or sparks, whether during normal operations or during malfunctions. In other words: "All of the circuits in intrinsically safe electrical devices (Ex i) are safe and are not capable of igniting explosive atmospheres".

What is the device category?

The device Group II (hazardous areas not including underground or above-ground mining operations) is divided into device categories 1, 2 and 3. They have the following safety levels:

Surroundings	Device category	Occurrence and duration of explosive atmosphere	Ignitable materials	Safety levels Permitted errors	Groups and zones Comparison
Group II	1	Constantly occurring Long-term Regularly	Gases, vapours, mist, dust	Very high safety level 2 different protection classes or 2 independent errors	Group II Zone 0 (gas) Zone 20 (dust)
Group II	2	Occurrence probable over a limited time period	Gases, vapours, mist, dust	High safety level 1 protection class For which no more than one error may occur	Gruppe II Zone 1 (gas) Zone 21 (dust)
Group II	3	Occurrence improbable Only for short periods	Gases, vapours, mist, dust	Normal I safety level Required protective measures	Group II Zone 2 (gas) Zone 22 (dust)

Safety in hazardous areas

Which explosion protection categories are most commonly used?

- Pressure-resistant encapsulation (Ex d) in compliance with EN60079-1:**
 Components that are capable of triggering an explosion are enclosed in a housing that is capable of withstanding the explosion. Openings in the housing are designed to prevent the explosion from being transmitted externally.
- Increased safety (Ex e) in compliance with EN60079-1:**
 This explosion protection category is normally applied to transformers, motors, batteries, terminal blocks, electrical lines and cables. It is not suitable for the protection of electronic components and spark-generating components (such as switches, relays or surge protection). Additional measures and an increased safety level are implemented in order to prevent any sparks, electrical arcing or unallowable high temperatures which could trigger ignitions. Increased safety is made possible by housing that prevents dusts from penetrating within.
- Explosion protection methods (Ex n):**
 This explosion protection category may only be used in the hazardous areas 2/22. Here there is no danger of an explosion from the electrical equipment during normal operations or during defined malfunctions. This includes all electrical devices and components that have no spark-forming contacts and that have a water-proof or dust-proof housing. Larger creepage and clearance distances are not required as long as the maximum rated voltage of 60 V AC / 70 V DC is maintained.
- Intrinsic safety (Ex i) in compliance with EN60079-11:**
 Power supply to electrical equipment is carried out through a safety barrier which functions to limit the current and voltage so that the minimum power and temperature levels for creating an explosive mixture are not reached. Intrinsic safety for electrical and electronic devices is specified so that their circulating or stored power (even in event of malfunction) is never strong enough to trigger an explosion in an explosive atmosphere. You must also remember that not only the electrical device but also all other components connected to the circuit may be exposed to the explosive atmosphere. All switching circuits in intrinsically safe devices must be designed so that they are also intrinsically safe.

These devices are divided into the category groups <ia> and <ib> which differ in the number of occurring malfunctions.

Category <ia>

=> Switching circuits within category <ia> electrical devices must not be able to cause a spark even if two independent malfunctions take place.

Category <ib>

=> Switching circuits in electrical devices must not be able to cause a spark when a malfunction.

Electrical devices for use in explosive gas, vapour and mist atmospheres – in accordance with CENELEC

Explosion protection type	Identification	Protective design
Pressure-resistant encapsulation	Ex d	Encloses the explosion and prevents fire from spreading
Increased safety	Ex e	No spark formation or hot surfaces
Method of explosion protection	Ex n	No spark formation or hot surfaces
Intrinsic safety	Ex i	Limited energy for preventing spark formation or overheated surface temperatures

CENELEC classification of gases, dusts and the maximum permitted surface temperatures of devices and components

Gas group	Temperature classes					
	T1	T2	T3	T4	T5	T6
I	Methane	-	-	-	-	-
IIA	Ammonia	Ethyl alcohol	Benzene,	Acetaldehyde	-	-
	Methane	Cyclohexane	Kerosene	-	-	-
	Ethane	n-Butane	-	-	-	-
	Propane	n-Hexane	-	-	-	-
IIB	Lighting gases, Acrylonitrile	Ethylene, Ethylene oxide	Ethylene glycol, Hydrogen sulphide	Ethyl ether	-	-
	IIC	Hydrogen	Ethine (Acetylen)	-	-	Hydrocarbons

IEC (group II) Classification	Max. surface temperature	Comment
T1	450 °C (842 °F)	The temperature is relevant to all parts of the devices that can come into contact with potentially explosive materials.
T2	300 °C (572 °F)	
T3	200 °C (392 °F)	
T4	135 °C (275 °F)	
T5	100 °C (212 °F)	
T6	85 °C (185 °F)	
Tx	Max. surface temperature undefined	Valid for the closed tank systems used on container ships where the individual contents cannot be monitored in event of a fire. It is the responsibility of the operator to assess each temperature class.

What labelling is considered proper?

An example of device labelling:

CE 0539		II	2	G	Ex ia	IIA	T4
↓	↓	↓	↓	↓	↓	↓	↓
Certification authority ex. DEMKO	European Commission mark for Ex devices	Device group "Surface"	Device category zone 1	Gas	Protection explosion type: intrinsically safe category <ia>	Gas group	Surface temperature: max 135 °C

ATEX directives

Since July 1, 2003, all new facilities in hazardous areas must be certified according to ATEX Directive 94/9/EG or ATEX 95 (ATEX: ATmosphère EXplosive = explosive atmosphere). This directive is one of the "New-Approach" directives. It is valid in all European Union countries, as well as Iceland, Lichtenstein and Norway. In these countries, the directive refers to the sale and commissioning of products which have been designed particularly for high explosion risk environments (where explosive atmospheres exist due to gases, vapours, mists, or dusts). It now also covers the mining sector and purely mechanical devices.

Class of protection

Type of protection	Code	CENELEC EN	IEC	Product category explosion protect.
General requirements	-	60079-0	60079-0	-
Oil immersion	o	60079-6	60079-6	2
Pressurised apparatus	p	60079-2	60079-2	2
Powder filling	q	60079-5	60079-5	2
Flameproof enclosure	d	60079-1	60079-1	2
Increased safety	e	60079-7	60079-7	2
Intrinsic safety	ia	60079-11	60079-11	1
Intrinsic safety	ib	60079-11	60079-11	2
Intrinsic safety	ic	60079-11	60079-11	3
Typ n (Ex n)	n	60079-15	60079-15	3
Encapsulation	m	60079-18	60079-18	2

Classification for potentially hazardous areas

CENELEC classification IEC60079-10	Presence of potentially explosive atmosphere	Product-category	US classification NEC 500	Combustible media
Zone 0	permanent, long-term	1G	Class I, Div 1	gases, vapours
Zone 20	or frequently	1D	Class II, Div 1	dust
Zone 1	occasionally	2G	Class I, Div 1	gases, vapours
Zone 20		2D	Class II, Div 1	dust
Zone 2	rarely and	3G	Class I, Div 2	gases, vapours
Zone 22	briefly	3D	Class II, Div 2	dust

Explosion groups

Gas (e.g.)	CENELEC	NEC 500
Propane	IIA	D
Ethylene	IIB	C
Hydrogen	IIC	B
Acetylene	IIC	A
Methane (mining)	I	mining (MSHA)

Temperature classes

Max. surface temperatur (°C)	Temperature class CENELEC	Temperature class NEC 500-3
450	T1	T1
300	T2	T2
280	-	T2A
260	-	T2B
230	-	T2C
215	-	T2D
200	T3	T3
180	-	T3A
165	-	T3B
160	-	T3C
135	T4	T4
120	-	T4A
100	T5	T5
85	T6	T6

Labelling for ATEX approval of a signal converter

II 3 G Ex nAnCnL IIC T4

- II** = Device group 2: devices for use in hazardous areas (except for mines and above-ground mining facilities that are exposed to flammable dusts or methane)
- 3** = Device category 3: the danger occurs rarely or only for short periods. The requirement is for normal security, suitable for use in zone 2.
- G** = Intended for the gas zone
- Ex** = Explosion protection
- nA** = Non-sparking equipment
- nC** = Enclosed facility (suitable protection)
- nL** = Equipment with limited power
- IIC** = Explosion groups: typical gas for C is hydrogen
- T4** = Temperature class: The max. permitted surface temperature for T4 is 135 °C

Zone 2 a zone for which, during normal operations, there is at most, only a short-term occurrence of dangerous hazardous atmospheres (mixtures of air and flammables gases, vapours or mists).

II (1) G [Ex ia] IIC/IIB/IIA

- II** = Device group 2: devices for use in hazardous areas (except for mines and above-ground mining facilities that are exposed to flammable dusts or methane)
- (1)** = Device category (1): Equipment from category 1 can be connected to this signal converter. The signal converter must be operated in the safe zone or in zone 2 (II 3 G ...).
- G** = Intended for the gas zone.
- [Ex ia]** = Explosion protection type: protected with intrinsic safety. This signal converter, as accompanying equipment, is intended to be used for the connection of intrinsically safe circuits.
- IIC/IIB/IIA** = Explosion groups – typical gases: propane for A, Ethylene for B, and hydrogen for C.

II (1) D [Ex iaD]

- II** = Device group 2: devices for use in hazardous areas (except for mines and above-ground mining facilities that are exposed to flammable dusts or methane)
- (1)** = Device category (1): Equipment from category 1 can be connected to this signal converter. The signal converter must be operated in the safe zone or in zone 2 (II 3 G ...).
- D** = Designed for the dust zone.
- [Ex iaD]** = Explosion protection type: protected with intrinsic safety. This signal converter, as accompanying equipment, is intended to be used for the connection of intrinsically safe circuits.



W

Design of clearance and creepage distances in electrical equipment – influencing factors

Rated impulse withstand voltage

The rated impulse withstand voltage is derived from:

- **Voltage conductor – earth**
(the rated voltage of the network, taking into account all networks)
- **Surge category**

Table 1: Rated impulse withstand voltages for electrical equipment

Rated voltage of power supplies system *) in V		Rated impulse withstand voltage in kV			
Three-phase systems	Single-phase systems with neutral point	Electrical equipment at the supplies point of the installation (Surge category IV)	Electrical equipment as part of the permanent installation (Surge category III)	Electrical equipment to be connected to the permanent installation (Surge category II)	Specially protected electrical equipment (Surge category I)
	120 to 240	4.00	2.50	1.50	0.80
230/400					
277/480		6.00	4.00	2.50	1.50
400/690		8.00	6.00	4.00	2.50
1000		Values depend on the particular project of, if no values are available, the values of the preceding line apply.			

*) to IEC 38

Surge categories

are stipulated in accordance with the German standard DIN VDE 0110-1 (for electrical equipment fed directly from the low-voltage network).

Surge category I

- Equipment that is intended to be connected to the permanent electrical installation of a building. Measures to limit transient surges to the specific level are taken outside the equipment, either in the permanent installation or between the permanent installation and the equipment.

Surge category II

- Equipment to be connected to the permanent electrical installation of a building, e.g. household appliances, portable tools, etc.

Surge category III

- Equipment that is part of the permanent electrical installation and other equipment where a higher degree of availability is expected, e.g. distribution boards, circuit-breakers, wiring systems (including cables, busbars, junction boxes, switches, power sockets) in the permanent installation, and equipment for industrial use and some other equipment, e.g. stationary motors with permanent connections to the permanent installation.

Surge category IV

- Equipment for use at or near the power supplies in the electrical installations of buildings, between the principal distribution and the mains, e.g. electricity meters, circuit-breakers and centralised ripple controllers.

Pollution severity categories

Pollution severity category 1

- No pollution, or only dry, non-conductive pollution that has no influence.

Pollution severity category 2

- Non-conductive pollution only; occasional condensation may cause temporary conductivity.

Pollution severity category 3

- Conductive pollution, or dry, non-conductive pollution that is liable to be rendered conductive through condensation.

Pollution severity category 4

- Contamination results in constant conductivity, e.g. caused by conductive dust, rain or snow.

Unless explicitly stated otherwise, the measurement of clearance and creepage distances and the resulting rating data for electromechanical components is based on pollution severity 2 and surge category III, taking account of all network types.

Derating curve (current-carrying capacity curve)

The **derating curve** shows which currents may flow continuously and simultaneously via all possible connections when the component is subjected to various ambient temperatures below its upper limit temperature.

The **upper limit temperature** of a component is the rated value determined by the materials used. The total of the ambient temperature plus the temperature rise caused by the current load (power loss at volume resistance) may not exceed the upper limit temperature of the component, otherwise it will be damaged or even completely ruined.

The current-carrying capacity is hence not a constant value, but rather decreases as the component ambient temperature increases. Furthermore, the current-carrying capacity is influenced by the geometry of the component, the number of poles and the conductor(s) connected to it.

The current-carrying capacity is determined empirically according to DIN IEC 60512-3. To do this, the resulting component temperatures t_{b1} , t_{b2} and the ambient temperatures t_{u1} , t_{u2} are measured for three different currents I_1 , I_2 .

The values are entered on a graph with a system of linear coordinates to illustrate the relationships between the currents, the ambient temperatures and the temperature rise in the component.

Base curve

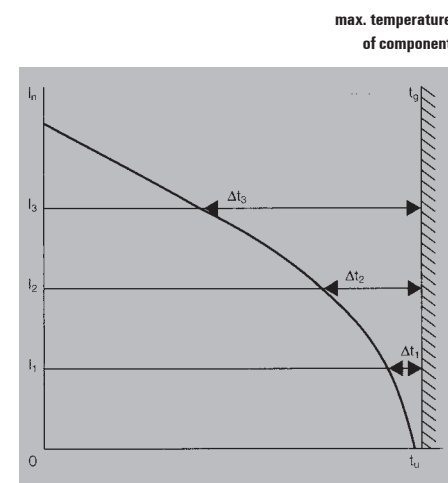

t_b = maximum temperature of component
 t_u = ambient temperature
 I_n = current

The **loading currents** are plotted on the y-axis, the **component ambient temperatures** on the x-axis.

A line drawn perpendicular to the x-axis at the upper limit temperature t_b of the component completes the system of coordinates.

The associated average values of the temperature rise in the component, $\Delta t_1 = t_{b1} - t_{u1}$, $\Delta t_2 = t_{b2} - t_{u2}$, are plotted for every current I_1 , I_2 to the left of the perpendicular line.

The points generated in this way are joined to form a roughly parabolic curve.

As it is practically impossible to choose components with the maximum permissible volume resistances for the measurements, the base curve must be reduced.

Derating curve

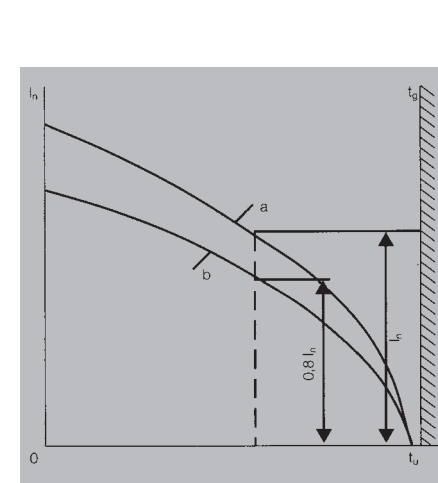

t_b = maximum temperature of component
 t_u = ambient temperature
 I_n = current
 a = base curve
 b = reduced base curve (derating curve)

Reducing the currents to 80 % results in the **“derating curve”** in which the maximum permissible volume resistances and the measuring uncertainties in the temperature measurements are taken into account in such a way that they are suitable for practical applications, as experience has shown. If the derating curve exceeds the currents in the low ambient temperature zone, which is given by the current-carrying capacity of the conductor cross-sections to be connected, then the derating curve should be limited to the smaller current in this zone.

General technical information

IP class of protection to DIN EN 60529

The class of protection is indicated by a code consisting of the two letters IP and two digits representing the class of protection.

Example: **I P 6 5**
 | |
 2nd digit: protection from liquids
 1st digit: protection from solid bod

Protection against intrusion of external particle matter (1st digit)

Digit		
0		No protection
1		Protection against ingress of large solid bodies with diameter > 50 mm. (Protection to prevent dangerous parts being touched with the back of the hand.)
2		Protection against ingress of large solid bodies with diameter > 12.5 mm. (Protection to prevent dangerous parts being touched with the fingers.)
3		Protection against ingress of large solid bodies with diameter > 2.5 mm. (Protection to prevent dangerous parts being touched with a tool.)
4		Protection against ingress of large solid bodies with diameter > 1 mm. (Protection to prevent dangerous parts being touched with a piece of wire.)
5		Protection against harmful deposits of dust, which cannot enter in an amount sufficient to interfere with satisfactory operation.
6		Complete protection against ingress of dust.

Protection against penetration of liquids (2nd digit)

Digit		
0		No protection
1		Protection against drops of condensed water falling vertically.
2		Protection against drops of liquid falling at an angle of 15° with respect to the vertical.
3		Protection against drops of liquid falling at an angle of 60° with respect to the vertical.
4		Protection against liquids splashed from any direction.
5		Protection against water jets projected by a nozzle from any direction.
6		Protection against water from heavy sea on ships' decks.
7		Protection against immersion in water under defined conditions of pressure and time.
8		Protection against indefinite immersion in water under defined conditions of pressure (which must be agreed between manufacturer and user and must be more adverse than number 7).

Glossary

1-9

2-way isolation	The input and output signals are separated electrically from each other and decoupled. Potential differences caused by long wire lengths and common reference points are eliminated.
3-way isolation	Also decouples the power supply to the input and output circuit and enables supply with only one operating voltage.

A

A/D converter	Converts standardised analogue current and voltage signals into an 8-bit, 12-bit or 16-bit digital signal. It may be necessary to convert analogue signals into digital signals when you need the analogue signal from the surroundings to work with the typical digital processing requirements of process monitoring.
AC	Alternating current
Accuracy	Describes the ability of an analogue signal isolating converter to transmit a measured value as precisely as possible. It is specified in the percent deviation from the measuring range end value at room temperature.
Active sensor	In an active sensor, an electrical signal is generated from the measurement itself, for example dynamometric or piezo-electric. Thus no auxiliary power source is required. Because of their physical operating principals (since energy cannot be sent during the static and quasi-static states), only a change in the measured variable can be detected.
Actuator	The actuator is a sensor counterpart – it converts electrical current into another form of energy.
Alarm contact	A switching contact that activates when a disturbance occurs (for example, an overload or short circuit).
Ambient temperature	DIN EN 60204-1 uses this term to refer to the temperature of the surrounding air or medium at which the equipment can be properly and safely operated. This is a part of the surrounding physical and operational conditions. Failure to maintain this temperature level can invalidate the product warranty.
Analogue signal	A signal is designated as an analogue signal if it transmits parameter information that is infinitely variable between a minimum and maximum value (this includes instantaneous values such as current, voltage or temperature). This applies to practically all real-world processes or states. It is theoretically possible to register any small signal changes (there is a very large dynamic range).

W

ATEX	<p>The ATEX directive from 23.4.1994 is valid within the EU and the EFTA Western European nations. It applies to devices, machinery components, controllers and protective systems that are to be used in hazardous areas. This directive harmonises the different national regulations from the EU member nations concerning the proper and intended use of machines and facilities in hazardous areas.</p> <p>ATEX is derived from the phrase "ATmosphere EXplosive". It stipulates that operators should prevent explosions and ensure protection.</p> <p>Regarding explosion protection in a potentially explosive atmosphere, the ATEX directive 94/9/EC has precedence over machinery directives and must be followed. The directive describes the following steps:</p> <ul style="list-style-type: none"> • Describe how often a potentially explosive atmosphere occurs and where it occurs. • These areas are then divided into zones according to the specifications. • Make sure that only properly categorised equipment is present within each different zone. As soon as an area is classified as being dangerous, steps must be taken to limit the potential ignition sources that are present there.
-------------	--

C

Calibration device	A special instrument used for the calibration and configuration of analogue signal conditioning devices. The calibration device produces highly precise standardised signals. It is equipped with a load indicator for quick loop diagnostics.
CE	Abbreviation for C ommunauté E uropéenne (the European Community). Manufacturers use the CE label to confirm that their products comply with the corresponding EC directives and the "essential requirements" therein.
Cold-junction compensation	Thermocouples require a temperature reference point to compensate for unwanted "cold junctions". The usual method for achieving this is by measuring the temperature at the reference junction with a temperature sensor that can be read immediately. The interfering voltage can then be compensated for in the measurement results. This process is referred to as cold-junction compensation (CJC).
Common-mode interference	Interfering currents and voltages that can occur on the connecting cables between electrical devices and facility components. These can then spread with similar phase and current direction to the feed line and the return line.
Counter	A counter can be used for measuring flow or for counting events. Analogue or digital input signals (pulses) may also be processed. Integrated functions such as linearisation, interference suppression, hysteresis configuration and reference values expand the range of use of a counter. Switching contacts are available on the output side for monitoring threshold.

W

Creepage and clearance distances

The safety gaps between two current-carrying wires. The creepage distance is the shortest path along an insulating surface between two live components. The clearance distance is the shortest path in the air between two points of reference.

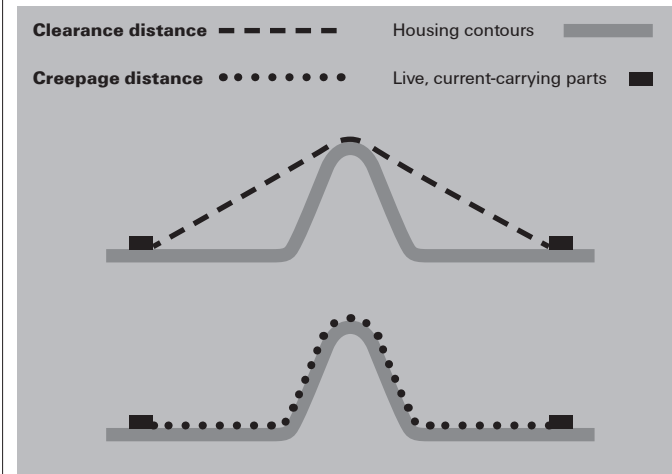

D

D/A converter

D/A converters convert standardised digital signals (for example, with an 8-bit structure) into analogue current and voltage signals. It may be necessary to convert digital signals into analogue signals when you need the analogue signal from the surroundings to work with the typical digital processing requirements of process monitoring.

DC

Direct current

Derating

The continuous current level reduction in relation to an ambient temperature increase, represented as a derating curve (a load reduction curve).

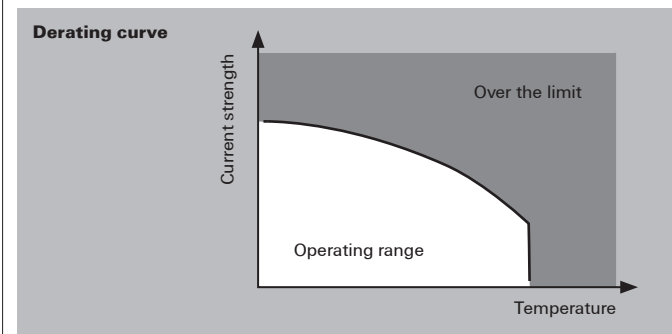

W

Device categories	The device category determines which equipment can be used in which zone. There are six device categories. The categories 1 G, 2 G and 3 G are classifications for gas explosion protection (G = Gas). Equipment with 1 G is suitable for zones 0, 1 and 2. Equipment with 2 G is suitable for zones 1 and 2. Equipment with 3 G is suitable for zone 2. The categories 1 D, 2 D and 3 D are classifications for dust explosion protection (D = Dust). Equipment with 1 D is suitable for zones 20, 21 and 22. Equipment with 2 D is suitable for zones 21 and 22. Equipment with 3 D is suitable for zone 22.
Device groups	Equipment is divided into groups I and II. Group I concerns underground mining while group II concerns explosion protection for gas and dust in all other applications.
DTM	DTMs (D evice T ype M anager) are software drivers that are vendor- and device-neutral. DTMs define functions for access to device parameters, troubleshooting, configuration and operation of devices. The DTM specifies all device-specific information, functions and rules (such as the device structure, communication capabilities, internal dependencies and the human-machine interface (HMI)). Device manufacturers make available a Device Type Manager (DTM) software driver for each device or device group.

E

EIA-232/ RS232	The term EIA-232 (originally RS232) refers to a serial interface standard developed by a U.S. standards committee (now known as the EIA – Electronic Industries Alliance) in the early 1960s. EIA-232 specifies the connection between the data terminal equipment (DTE) and the modem (data communication equipment or DCE). It defines timing, voltage level, plug and protocol details. EIA-232 defines a voltage interface. The information bits are encoded using electrical voltage. The data lines (TxD and RxD) use a negative logic whereby a voltage level between -3 V and -15 V (ANSI/EIA/TIA-232-F-1997) represents a logical one and a voltage level between +3 V and +15 V represents a logical zero. Signal levels between -3 V and +3 V are undefined.
EIA-422/ RS422	EIA-422 (also known as RS422) is an interface standard for cable-based differential, serial data transmission. In contrast to the asymmetric serial interface specified by the EIA-232 standard, the EIA-422 interface is designed for symmetric transmissions. This means that two sets of twisted pair wires are required to carry the positive and negative signals from the sender to the receiver. This minimises common-mode interferences and also increases the data rates in comparison to the asymmetric EIA-232 interface. EIA-422 can be used to establish a full-duplex, point-to-point connection. Multi-drop networks with one sender and up to ten receivers are also possible. The sender and receiver in multi-drop networks can only be operated in half-duplex (in one direction). Because of the high data rate (up to several MBit/s), a wire pair on the EIA-422 interface must be terminated with a terminating resistor (normally 120 ohm).

EIA-485/ RS485	EIA-485, also referred to as RS485, is an interface standard for digital, cable-based, differential, serial data transmissions. EIA-485 uses a wire pair for transmitting inverted and non-inverted levels for a single-bit data signal. The original data signal is reconstructed by the receiver as the difference between the two voltage levels. This has the advantage of increasing the resistance to interference, since common-mode interference then has no effect on the transmission. The EIA-485 interface operates with a voltage differential of +/-200 mV, so that the voltage interface has a differential related to half of the operational voltage. It normally uses a single wire pair and is operated in half-duplex. However full-duplex operations are possible with two wire pairs. This connection has multi-point capabilities; up to 32 nodes can be connected to an EIA-485 bus. Standard cable lengths run up to 1.2 km in length and support transmission speeds up to 10 MBit/s. The wire pairs must be terminated with resistors (typically 120 Ohm) because of the cable length and high data rates.
Electrical equipment	All of the electrical and electronic components and circuits within an enclosure.
Explosion groups	Depending on the ignition protection, explosion-protected equipment intended for gases, vapours and mists are divided into three explosion groups (IIA-IIB-IIC). The explosion group provides a measure of the explosive break-through capability of gases (in an explosive atmosphere). The requirements for the equipment increase in strictness from II A to II C.
Explosion protection types	<p>The ignition protection type is a term used in explosion protection that refers to the various types of protective construction designed into the product. Ignition protection types are formulated to minimise the risk that an ignition source will be present in an explosive atmosphere.</p> <p>The following ignition protection types are specified:</p> <ul style="list-style-type: none"> • For electrical equipment in a gas <ul style="list-style-type: none"> • Intrinsic safety Ex i • Pressure-resistant Ex d encapsulation • Increased safety Ex e • Pressurization encapsulation Ex p • Oil immersion Ex o • Moulded encapsulation Ex m • Sand encapsulation Ex q • Ignition protection type for zone 2 Ex n • Special ignition protection type Ex s • For electrical equipment in dust <ul style="list-style-type: none"> • Pressurization encapsulation Ex pD • Intrinsic safety Ex iD • Moulded encapsulation Ex mD • Protection provided by housing Ex tD

Explosive atmospheres	This is defined as a mixture of flammable materials and oxygen. An ignition leads to a explosive burning process throughout the entire mixture. Usually the oxygen is supplied by the surrounding air. Flammable materials may be gases, liquids, vapours, mists or dusts. Explosion protection considers this to be normal atmospheric conditions. The explosiveness of the mixture depends of the flammability of the materials and the concentration of air or oxygen.
------------------------------	---

F

Flammability rating	Flammability class specification according to the American UL 94 specification. Duration of burning, annealing time and the burning drop formation are all taken into account. The highest category is V-0.
Frequency converter	Converts frequencies into analogue signals (or vice versa). In-line control systems can then directly process pulse strings from speed or rotational measurements.

G

Galvanic isolation	Potential-free isolation between electrical components. Normally, the inputs circuit, output circuit and power supply are designed so that they are electrically isolated from each other. The isolation can be achieved using optical means (an optocoupler) or by using a transformer. The electrical isolation of measurement signals ensures that the differences in earth potentials and common-mode interference are suppressed
GOST-R	The Russian certification for products, materials and technical facilities.

H

Hall sensor current measurement	Hall sensors can measure the magnetic field of a conducting wire. They then generate a proportional voltage on the measurement output (the Hall voltage). This can be converted to a standardised signal by means of an amplifier circuit. Such a measurement is well suited for measuring high DC and AC currents with frequencies up to 1 kHz. Start-up currents and current peaks cannot damage a Hall sensor.
--	---

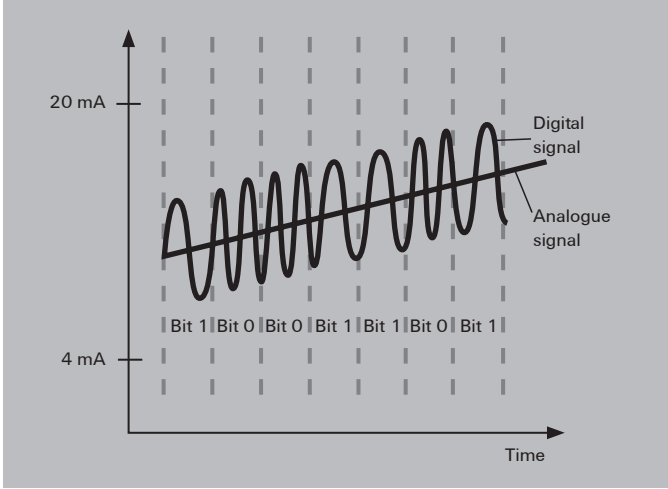
<p>HART®</p>	<p>HART® (Highway Addressable Remote Transducer) is a communications protocol for bus-addressed field devices used in process automation. In HART®-based communications, field devices and controllers are connected together over 4–20 mA current loops. This analogue signal is superimposed with a digital signal by using the FSK process (Frequency Shift Keying). The process allows additional measurements, configuration and device data to be transmitted without influencing the analogue signal. Ex isolators can also be used in hazardous areas.</p> 
<p>Hazardous area</p>	<p>According to the ATEX directive, an hazardous area is where the extent of the explosive atmosphere mandates that extra measures must be taken to safeguard health and protect surrounding machinery. Hazardous areas are classified according to the frequency and duration of the occurrence of the explosive atmosphere (refer to the sub-divided zones).</p>
<p>Hysteresis</p>	<p>Specifies the percent difference between the switch-on and switch-off points of a switching contact. The hysteresis must not fall below a minimal value. Otherwise it would no longer be possible to carry out specific switching during the monitoring of threshold.</p>

<p>IECEX</p>	<p>An international directive regarding the creation of declarations of conformity by the manufacturers of facilities, devices and components that are intended for use in explosion risk zones. This directive is valid throughout the globe but is only currently used in some Asian nations.</p>
<p>Impulse withstand voltage</p>	<p>The high pulse voltage of a specified form and polarity that does not lead to an insulation breakthrough or flashover, under the specific conditions defined in EN 60664-1.</p>

Initiator PNP/NPN switched	Two wires in a three-wire sensor are responsible for keeping the supply activated. The third connecting wire is used for transferring commands (NO/NC contact). Initiators with NPN outputs switch the load in active mode towards the minus potential. Proximity switches with PNP outputs switch toward the plus potential.
Insulation voltage	For electronics components with electrical isolation, this is the maximum AC test voltage that can be applied for a specified time interval (5 s / 60 s) without causing a break-through.
Intrinsic safety "i"	Electrical equipment for hazardous areas with the ignition protection type "Intrinsic safety Ex i" Intrinsic safety is divided into ignition protection types "ia" or "ib" The ignition protection type "intrinsic safety" is a protective strategy that requires a complex analysis of electronic devices. So it is not only important to protect intrinsically safe current from the other unsafe circuits. It is also important to limit the open-circuit voltage, short-circuit current, power, stored energy and the surface temperature of components that will be exposed to the explosive atmosphere. Intrinsically safe circuits are circuits where a spark or thermal effect (as may occur under the testing conditions specified by EN 60079-1 1) is not capable of igniting an explosive atmosphere (of sub-groups IIA, IIB or IIC) or a dust-air mixture. The testing conditions cover normal operations and certain error conditions as specified in the standard.
IP protection classes	Equipment is assigned an IP protection class to indicate which environmental conditions it can be used in.
Isolation amplifier (active isolator)	An isolation amplifier is used to provide electrical isolation for analogue standard signals. They are designed with 2-way or 3-way isolation. The isolation of the potentials eliminates interference on the measurement signal that can be caused by earth loops or common-mode noise. The active isolator makes use of a separate voltage source for its power supply. It functions without feedback; a change on the output side load does not influence the input circuit.

L

Leakage current	The current on the load side of an optocoupler that flows towards the output circuit while in a closed state.
Limiting frequency	The limiting frequency of an analogue signal isolating converter is that frequency where the output signal is reduced to $1/\sqrt{2}$ of the value of the input signal (approx. 70.7 % = -3 dB).
Line break monitoring	Analogue measuring transducer with wire-break detection capability that permanently monitors the input signal. In the event of a fault (a wire break), the output signal jumps up to a defined value over the nominal range so that a controller wired further down the circuit can evaluate the error.

W

Linearisation	Temperature-dependent components normally do not have a linear characteristic curve. Their characteristic curves must be linearised so that they can be evaluated as precisely as possible. The measurement curves of thermocouples and temperature-dependent resistors (NTC/ PTC), in particular, exhibit significant deviation from an "ideal curve". In the linearisation process, the measurement signal is processed by a microprocessor and an ideal characteristic curve is generated which can then be analysed or processed further.
Load cell	A load cell is a special type of force sensor used in weighing systems (i.e., with scales). They are calibrated in grams (g), kilograms (kg) or tons (t). Load cells usually have a spring mechanism used as a force sensor. The spring is a specially shaped piece of metal whose shape changes slightly when under the influence of weight. This elastic deformation is recorded by strain gauges and converted into an electrical signal. Weights can be recorded ranging from a few hundred grams to several thousand tons.
Load resistance (load)	This is the load resistance on the output side of a measuring transducer or transmitter. For analogue current outputs, the load is 500–600 ohms maximum. Voltage outputs normally have a load of at least 10 kOhm.

M

Measurement isolating transformer	Converts electric and non-electric input signals into standard analogue signals. At the same time it provides electrical isolation between the input and output (2-way isolation) or between the input, output and supply (3-way isolation). Measurement isolators are typically used to record temperatures (RTD, thermocouples) or for measuring current, voltage, power, frequency, resistance and conductivity.
Measuring bridge	Sensors based on Wheatstone bridge circuitry can capture force, pressure and torque. Relatively small length changes under 10 – 4 mm can be recorded using DMS strain gauges in the form of resistance changes. A typical application is for capturing measurements in load cells.

N

Namur sensor	NAMUR-compliant sensors (The standardization commission for measuring and control technology in the German chemical industry) operate with a load-independent current. They have four modes so that an analogue evaluative unit can detect a sensor malfunction. 1) Current of 0 mA => wire break, circuit is open 2) Current of approx. 20 % of the max. value => Sensor ready, activated 3) Current of approx. 60 % of the max. value => Sensor ready, not activated 4) Current at max. value => short circuit, max. current NAMUR sensors are suited for use in hazardous areas.
NEC 500 – 505	The relevant directives for the classification of explosion protection in the USA. NEC 500 regulates the standard Ex classifications (class – division – model). The NEC 505 defines the zone model based on the European and IEC classifications.

W

Nominal switching current – load side	The permitted load current of a relay contact or semiconductor contact when in continuous operations.
Nominal switching voltage – load side	The switching voltage that a relay contact or semiconductor contact uses in relation to its application.

O

Output-current loop-powered	Output loop powered 2-wire transmitters have a 4 – 20 mA output. The transmitter is supplied with power via the current loop on the output side. A typical loop consists of a regulated DC power supply, the 2-wire transmitter and a receiving device.
Overvoltage category	<p>The overvoltage categories are described in DIN EN 60664-1. The category dictates the insulation clearance gaps required. Category III is the default specification (EN 50178).</p> <ul style="list-style-type: none"> • Overvoltage category I Devices that are intended to be connected to the permanent electrical building installation. The measures for limiting transient surge voltages to the proper level are taken outside of the device. The protective mechanisms can either be in the permanent installation or between the permanent installation and the device. • Overvoltage category II Devices that are intended to be connected to the permanent electrical building installation (such household appliances or portable tools). • Overvoltage category III Devices that are a part of the permanent installation and other devices where a higher degree of availability is required. This includes the distributor panels, power switches, distribution systems (including cable, busbars, distributor boxes, switches and outlets) that are part of the permanent installation, devices intended for industrial use, and devices that are continually connected to the permanent installation (such as stationary motors). • Overvoltage category IV Devices that are intended to be used on or near the power feed in a building's electrical installation – ranging from the main distribution to the mains power system. This includes electrical meters, surge protection switches and ripple control equipment.

P

Passive isolator/ input loop powered	<p>Generates its power supply from the input signal (0/4–20 mA). The amount of current needed internally is so small that the measurement signal is not influenced. Transformers are used to provide the isolation between the input and the output.</p> <p>The advantages include: eliminates the influence of the mains power system, highly accurate, minimal signal delay, and minimal power used. Passive isolators do not function free from feedback; so a load change on the output circuit will automatically effect the input circuit as well.</p>
Passive sensor	<p>Contains passive components whose parameters can be changed by the measured variables. A primary electronic mechanism converts these parameters into electric signals. An auxiliary external power source is needed for the passive sensor. Passive sensors can be used to determine both static and semi-static measured variables. For this reason, the majority of sensors have a passive construction. Examples of this type include load cells and resistance thermometers.</p>
Pollution severity level	<p>The pollution severity level specifies the conditions of the immediate surroundings. It is defined in DIN EN 50178, Section 5.2.15.2. The pollution (contamination) severity level should be used to determine the required creepage distance for the insulation. Pollution degree 2 is the default specification.</p> <ul style="list-style-type: none"> • Pollution severity level 1 There is no contamination or only dry occurrences of non-conductive pollution. This pollution has no influence. • Pollution severity level 2 There is only non-conductive pollution. Temporary occurrences of conductivity caused by condensation may also occur. • Pollution severity level 3 Conductive pollution or dry, non-conductive pollution that can become conductive due to condensation is likely to occur. • Pollution severity level 4 The contamination leads to continual conductivity which can be caused by such contaminants as conductive dust, rain or snow.

R

Rated voltage	<p>Specified by the insulation coordination – the rated voltage is the voltage level at which the product can be safely operated, in relation to the corresponding pollution severity level and the surge voltage category.</p>
Relative humidity	<p>The relationship between the actual moisture and the maximum possible quantity of water in the air. Expressed as a percentage.</p>

W

RoHS	The EC directive 2002/95/EC – concerning the restriction of the use of certain hazardous substances in electrical and electronic equipment – regulates the use of hazardous materials within devices and components. This directive, and its various implementations into national laws, are referred to by the abbreviation RoHS (Restriction of Hazardous Substances).
RTD/ PT100/ 1000	<p>RTD sensors are temperature probes that operate based on the resistance changes which take in metal as the temperature changes. They are resistance thermometers based on PTC resistors. The electrical changes in resistance of a platinum wire or platinum film is often used for measuring temperatures ranging from -200 °C to 850 °C. The platinum temperature sensors are characterised by their nominal resistance R0 at a temperature of 0 °C. The standard types include:</p> <ul style="list-style-type: none"> • PT100 (R0= 100 Ohm) • PT1000 (R0= 1 kOhm) <p>A two-wire, three-wire or four-wire electrical connection can be used to electrically connect the PT/RTD sensor to the evaluative electronics. A three-wire or four-wire method eliminates any errors caused by the inherent resistance of the sensor connecting wires.</p> <p>In the three-wire method, one end is equipped with two pigtail connectors. In the four-wire method, both ends are equipped with two pigtail connectors.</p>

S

Self-heating	Self-heating refers to the temperature increase in an operating device caused by the internal power loss.
Sensor	A sensor is a physical component capable of capturing certain physical or chemical properties (such as thermal radiation, temperature, humidity, pressure, noise, brightness or acceleration) as a measurement. It may also be able to analyse the quality of the composition of the material surroundings. These values are captured using physical or chemical phenomena and then converted into another form (usually electrical signals) so they can be post-processed.
Signal distributorsplitter	A signal isolator that accepts an analogue input signal and delivers at least two signals on the output side. This permits the signal to be transmitted to a PLC/DCS system and to a separate display. A signal multiplier is designed either as an active isolator with an external power feed or as an output loop powered version.
SIL	<p>Safety Integrity Level.</p> <p>The components must meet the requirements of IEC 61508 in order to reduce risk. This standard provides general requirements for avoiding and minimising device and equipment outages. It stipulates organization and technical requirements concerning device development and operation. Four safety levels are defined (from SIL1 for minimal risk to SIL4 for very high risk) for classifying facilities and risk-reduction measures. Risk-reduction measures must be more reliable when the classified risk level is higher.</p>
Status indicator	An LED that displays the operational status, such as operational (yellow), switching (green), and alarm/malfunction (red).
Step response time	This is the time delay in the output signal change when there is a signal jump ranging from 10 to 90 % on the input side. The step response time is inversely proportional to the limiting frequency
Storage temperature	The permitted ambient temperature, related to a specific relative humidity level, for which the product should be stored while in a current-free state.

Switching threshold	The switch-on or switch-off point.
----------------------------	------------------------------------

T

Temperature classes	Explosion-protected equipment that is to be installed into the Ex zone is subdivided into six temperature classes (T1 to T6). These temperature classes define the maximum surface temperature permitted for the equipment. The definition is based on an ambient temperature of +40 °C. This temperature may not be exceeded on any part of the equipment at any point in time. In all cases, the maximum surface temperature must be lower than the ignition temperature of the surrounding medium. The requirements placed on the equipment become stricter from class T1 to T6.
----------------------------	---

Temperature coefficient	The temperature coefficient describes the relative change of a physical variable based on the temperature change relative to a reference temperature (room temperature). It directly influences the precision of an analogue signal converter. The coefficient is specified in ppm/K of the corresponding measuring range end value.
--------------------------------	--

Thermocouple	<p>A thermocouple is a component made of two different materials which are connected to each other at one end. An electrical voltage is created (based on the principle of the Seebeck effect) along a wire that connects the unattached ends when there is a temperature differential.</p> <p>The juncture point and the unattached ends must have different temperatures for a voltage to be generated.</p>
---------------------	---

The following thermocouples are used for industrial applications:

Thermal pair	Short name	Type	Temperature range in °C
Nickel/Chrome-Nickel/Al	NiCr-Ni/Al	K	-200 ... +1372
Iron-constantan	Fe-CuNi	J	-200 ... +1200
Copper-constantan	Cu-CuNi	T	-200 ... +400
Nickel/Chrome constantan	NiCr-CuNi	E	-200 ... +1000
Platinum/10 % Rhodium-Platinum	Pt10Rh-Pt	S	-50 ... +1760
Platinum/13 % Rhodium-Platinum	Pt13Rh-Pt	R	-50 ... +1760
Nickel/Chrome-Nickel/Magnesium	NiCr-NiMg	N	-200 ... +1300
Platinum/30 % Rhodium - Platinum/6 % Rhodium	Pt30Rh - Pt6Rh	B	0 ... +1820

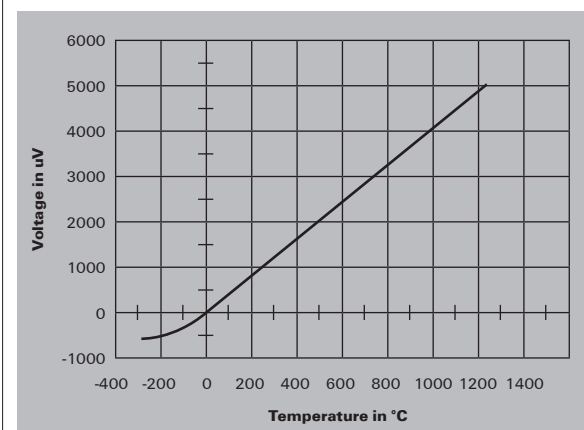

W

Threshold monitoring	The limiting values of physical variables must be continually monitored for industrial processes. This includes fill levels, temperatures, speed, positions, weights and frequencies. Specialised threshold monitoring components are used for this purpose. The sensor signals are captured on the input side, evaluated electronically and converted. The corresponding threshold (min/max) are then made available via the digital switching outputs (relays or transistors) to the external devices. Potentiometers can be used to customise each switching point and its minimum/maximum threshold as well as the switching hysteresis.
Transformer-based current measurement	Signal converters with transformer coupling are used for taking cost-effective measurements of sinusoidal currents (50/60 Hz). The current being measured flows directly through the primary coil of the measurement transformer. It is then stepped down and electronically processed in the converter.
True RMS value	True RMS is the measure of the active component of alternating current and voltages. The root mean square (RMS) is a measure of the magnitude of varying quantities (such as alternating current and voltage). It is a constant value that relates to the power consumed by a resistive load in a specified time period. The RMS is dependent on the amplitude and the curve slope. Non-sinusoidal signals can only be measured and processed with "true RMS"-compliant devices.
TTY	The TTY interface is a serial interface. This interface is often referred to as a 20-mA-current interface since a constant DC current of 20 mA flows through it during the idle state. In contrast to RS232, the data transmission for the asymmetric signal connection is not controlled by voltage changes but by a load-independent line current (typically 20 mA for High and 0 mA for Low). Thus there is no significant length-dependent voltage loss to take into consideration. Here the cable lengths can run up to several kilometres. TTY interfaces are currently used mostly where dedicated connections are required: for exchanging data between electronic scales, for large industrial displays, or for log printers.
Type of contact	A contact is called normally open (NO) or a make contact if it is open when the armature is dropped out (no current in coil) and closed when the armature is picked up (current flowing in coil). A contact is called a break contact or normally closed (NC) contact if it interrupts the circuit when the armature is picked up. A combination of NC and NO is called a changeover (CO) contact. A relay may have one or more of such contacts: NC – Normally Closed = break contact (11, 12: NC contact) NO – Normally Open = make contact (13, 14: NO contact) CO – Change Over contact (11, 12, 14: CO contact (11 is the shared (root) contact))

Z

Zone division	<p>Hazardous areas are divided into zones. These divisions take into account the various risks from explosive atmospheres. The corresponding explosion protection can then be implemented economically and safely in accordance with the particular conditions of the zone. The zone definitions in the ATEX directive provide comprehensive regulations for the European Community.</p> <p>IEC 60079-10 is valid for gases and vapours. A similar classification is used for facilities in the USA which are covered by the US standard NEC 505.</p> <p>IEC 61241-3 covers the division into zones according to the dust level.</p> <p>Explosion risk areas are classified into zones according to likelihood of explosive atmospheres occurring and their persistence:</p> <p>Zone 0: this zone has an explosive atmosphere that is a mixture of air and flammable gases, vapours or mists. The mixture is present frequently or over long periods.</p> <p>Zone 1: an explosive atmosphere may occasionally occur in this zone under normal operating conditions.</p> <p>Zone 2: an explosive atmosphere is not likely to occur in this zone or may only occur briefly.</p> <p>Zone 20: this zone has an explosive atmosphere that is a flammable mixture of air and dust. The mixture is present often or over long periods.</p> <p>Zone 21: an explosive atmosphere, in the form of a flammable dust/air mixture, may occasionally occur in this zone under normal operating conditions.</p> <p>Zone 22: an explosive atmosphere, in the form of a flammable dust/air mixture, is not likely to occur in this zone or may only occur briefly.</p>
----------------------	---

W

Index

Contents

Index

Index	Index Type	X.2
	Index Order No.	X.4

X

Type	Order No.	Page
------	-----------	------

ACT20C-AI-AD-MTCP	1334490000	D.7
ACT20C-CMT-10-AD-RC-S	1510240000	D.12
ACT20C-CMT-60-AD-RC-S	1510420000	D.12
ACT20C-GTW-100-MTCP-S	1510370000	D.11
ACT20C-LBT-10	1510340000	D.13
ACT20-FEED-IN-BASIC-S	1282490000	C.29
ACT20-FEED-IN-BASIC-S	1282490000	G.9
ACT20-FEED-IN-PRO-S	8965500000	C.29
ACT20-FEED-IN-PRO-S	8965500000	G.9
ACT20M-2CI-2CD-ILP-S	1176080000	C.18
ACT20M-2CI-2CD-OLP-S	1176050000	C.19
ACT20M-AI-2AO-S	1176020000	C.11
ACT20M-AI-AD-E-S	1176010000	C.15
ACT20M-AI-AD-S	1176000000	C.14
ACT20M-BAI-2AO-S	1375470000	C.12
ACT20M-BAI-AD-S	1375450000	C.16
ACT20M-CI-2CD-S	1175990000	C.10
ACT20M-CI-CD-ILP-S	1176070000	C.18
ACT20M-CI-CD-OLP-S	1176040000	C.19
ACT20M-CI-CD-S	1175980000	C.13
ACT20M-RT-CI-CD-OLP-S	1435590000	C.20
ACT20M-RTI-AD-E-S	1375520000	C.23
ACT20M-RTI-AD-S	1375510000	C.22
ACT20M-RTI-CD-FOIP-S	1435610000	C.21
ACT20M-TCI-AD-E-S	1375600000	C.25
ACT20M-TCI-AD-S	1375480000	C.24
ACT20M-UI-AD-S	1176030000	C.17
ACT20P-2CI-2CD-12	7760054117	D.18
ACT20P-2CI-2CD-12	7760054117	D.28
ACT20P-AI-AD-DC-S	1477420000	D.18
ACT20P-AI-AD-DC-S	1477420000	D.25
ACT20P-BRIDGE-S	1067250000	D.18
ACT20P-BRIDGE-S	1067250000	D.37
ACT20P-CI-2CD	7760054115	D.18
ACT20P-CI-2CD	7760054115	D.26
ACT20P-CI-CD	7760054114	D.18
ACT20P-CI-CD	7760054114	D.27
ACT20P-CMT-10-AD-RC-S	1510470000	D.18
ACT20P-CMT-10-AD-RC-S	1510470000	D.33
ACT20P-CMT-30-AD-RC-S	1510540000	D.18
ACT20P-CMT-30-AD-RC-S	1510540000	D.33
ACT20P-CMT-60-AD-RC-S	1510440000	D.18
ACT20P-CMT-60-AD-RC-S	1510440000	D.33
ACT20P-CMT-60-RC-S	1510390000	D.33
ACT20P-PRO-DCDC-II-S	1481970000	D.18
ACT20P-PRO-DCDC-II-S	1481970000	D.21
ACT20P-UI-2RCD-DC-S	7940045760	D.18
ACT20P-UI-2RCD-DC-S	7940045760	D.31
ACT20P-UI-AD-DO-LP-S	1453210000	D.18
ACT20P-UI-AD-DO-LP-S	1453210000	D.23
ACT20X-2HAI-2SAO-S	8965440000	B.7
ACT20X-2HDI-2SDO-RNC-S	8965380000	B.17
ACT20X-2HDI-2SDO-RNO-S	8965370000	B.17
ACT20X-2HDI-2SDO-S	8965390000	B.19
ACT20X-2HTI-2SAO-S	8965480000	B.11
ACT20X-2SAI-2HAO-S	8965460000	B.9
ACT20X-2SDI-2HDO-S	8965420000	B.21
ACT20X-C.I.C.HTI-S PRT 11	1160640000	G.10
ACT20X-C.I.C.HTI-S PRT 21	1160650000	G.10
ACT20X-HAI-SAO-S	8965430000	B.7
ACT20X-HDI-SDO-RNC-S	8965350000	B.17
ACT20X-HDI-SDO-RNO-S	8965340000	B.17
ACT20X-HDI-SDO-S	8965360000	B.19
ACT20X-HTI-SAO-S	8965470000	B.11
ACT20X-HUI-SAO-LP-S	1318220000	B.15
ACT20X-HUI-SAO-S	8965490000	B.13
ACT20X-SAI-HAO-S	8965450000	B.9
ACT20X-SDI-HDO-H-S	8965410000	B.23
ACT20X-SDI-HDO-L-S	8965400000	B.21
AMS400A 4-20mA/AO	7940011895	F.17
AP MCZ 1.5	8389030000	G.12

B

BHZ 5.00/02/90LH BK/BK PRT 41	1086040000	G.10
BHZ 5.00/02/90LH BK/BL PRT 11	1086250000	G.10
BHZ 5.00/02/90LH BK/BL PRT 21	1086260000	G.10
BHZ 5.00/04/90LH BK/BK PRT 11	1086130000	G.10
BHZ 5.00/04/90LH BK/BK PRT 15	1086190000	G.10
BHZ 5.00/04/90LH BK/BK PRT 21	1086140000	G.10
BHZ 5.00/04/90LH BK/BK PRT 25	1086200000	G.10
BHZ 5.00/04/90LH BK/BK PRT 31	1086150000	G.10
BHZ 5.00/04/90LH BK/BK PRT 35	1086210000	G.10
BHZ 5.00/04/90LH BK/BK PRT 41	1086160000	G.10
BHZ 5.00/04/90LH BK/BK PRT 45	1086220000	G.10
BHZ 5.00/04/90LH BK/BK PRT 51	1086170000	G.10
BHZ 5.00/04/90LH BK/BK PRT 55	1086230000	G.10
BHZ 5.00/04/90LH BK/BK PRT 61	1086180000	G.10
BHZ 5.00/04/90LH BK/BK PRT 65	1086240000	G.10
BHZ 5.00/04/90LH BK/BL PRT 11	1086370000	G.10
BHZ 5.00/04/90LH BK/BL PRT 15	1086430000	G.10
BHZ 5.00/04/90LH BK/BL PRT 21	1086380000	G.10
BHZ 5.00/04/90LH BK/BL PRT 25	1086440000	G.10
BHZ 5.00/04/90LH BK/BL PRT 31	1086390000	G.10
BHZ 5.00/04/90LH BK/BL PRT 35	1086450000	G.10
BHZ 5.00/04/90LH BK/BL PRT 41	1086400000	G.10
BHZ 5.00/04/90LH BK/BL PRT 45	1086460000	G.10

Type	Order No.	Page
------	-----------	------

BHZ 5.00/04/90LH BK/BL PRT 51	1086410000	G.10
BHZ 5.00/04/90LH BK/BL PRT 55	1086470000	G.10
BHZ 5.00/04/90LH BK/BL PRT 61	1086420000	G.10
BHZ 5.00/04/90LH BK/BL PRT 65	1086480000	G.10
BLZ 5.08/02/180 SN OR BK	1526460000	G.13
BLZ 5.08/02/180 SN OR PRT	2246070000	G.13
BLZ 5.08/02/180 SN OR PRT	2246080000	G.13
BLZ 5.08/02/180 SN OR PRT	2246090000	G.13
BLZ 5.08/02/180 SN OR PRT	2246100000	G.13
BLZ 5.08/03/180 SN OR PRT	2242030000	G.13
BLZ 5.08/03/180 SN OR PRT	2242050000	G.13
BLZ 5.08/03/180 SN OR PRT	2242060000	G.13
BLZ 5.08/03/180 SN OR PRT	2242070000	G.13

C

CBX200 USB	8978580000	G.4
CH20M BUS 4.50/05 AU/250	1248220000	C.27
CH20M BUS 4.50/05 AU/250	1248220000	D.15
CH20M BUS 4.50/05 AU/250	1248220000	G.7
CH20M BUS 4.50/05 AU/500	1248230000	C.27
CH20M BUS 4.50/05 AU/500	1248230000	D.15
CH20M BUS 4.50/05 AU/500	1248230000	G.7
CH20M BUS 4.50/05 AU/750	1248240000	C.27
CH20M BUS 4.50/05 AU/750	1248240000	D.15
CH20M BUS 4.50/05 AU/750	1248240000	G.7
CH20M BUS-ADP TS 35/250	1248250000	C.27
CH20M BUS-ADP TS 35/250	1248250000	D.15
CH20M BUS-ADP TS 35/250	1248250000	G.7
CH20M BUS-ADP TS 35/500	1248260000	C.27
CH20M BUS-ADP TS 35/500	1248260000	D.15
CH20M BUS-ADP TS 35/500	1248260000	G.7
CH20M BUS-ADP TS 35/750	1248270000	C.27
CH20M BUS-ADP TS 35/750	1248270000	D.15
CH20M BUS-ADP TS 35/750	1248270000	G.7
CH20M BUS-AP LI TS 35X7.5 & amp; 15	1193160000	C.27
CH20M BUS-AP LI TS 35X7.5 & amp; 15	1193160000	D.15
CH20M BUS-AP LI TS 35X7.5 & amp; 15	1193160000	G.7
CH20M BUS-AP RE TS 35X7.5 & 15	1193170000	C.27
CH20M BUS-AP RE TS 35X7.5 & 15	1193170000	D.15
CH20M BUS-AP RE TS 35X7.5 & 15	1193170000	G.7
CH20M BUS-PROFIL TS 35X15/250	1248180000	C.27
CH20M BUS-PROFIL TS 35X15/250	1248180000	D.15
CH20M BUS-PROFIL TS 35X15/250	1248180000	G.7
CH20M BUS-PROFIL TS 35X15/500	1248190000	C.27
CH20M BUS-PROFIL TS 35X15/500	1248190000	D.15
CH20M BUS-PROFIL TS 35X15/500	1248190000	G.7
CH20M BUS-PROFIL TS 35X15/750	1248210000	C.27
CH20M BUS-PROFIL TS 35X15/750	1248210000	D.15
CH20M BUS-PROFIL TS 35X15/750	1248210000	G.7
CH20M BUS-PROFIL TS 35X7.5/250	1248150000	C.27
CH20M BUS-PROFIL TS 35X7.5/250	1248150000	D.15
CH20M BUS-PROFIL TS 35X7.5/250	1248150000	G.7
CH20M BUS-PROFIL TS 35X7.5/500	1248160000	C.27
CH20M BUS-PROFIL TS 35X7.5/500	1248160000	D.15
CH20M BUS-PROFIL TS 35X7.5/500	1248160000	G.7
CH20M BUS-PROFIL TS 35X7.5/750	1248170000	C.27
CH20M BUS-PROFIL TS 35X7.5/750	1248170000	D.15
CH20M BUS-PROFIL TS 35X7.5/750	1248170000	G.7

D

DI350 0-10V/0-100.0	7940011570	F.19
DI350 4-20mA/0-100.0	7940010185	F.19

E

ESG 6 6/20 BHZ 5.00/04	1082540000	G.10
ESG 8/13.5/43.3 SAI AU	1912130000	G.10
ESG 8/13.5/43.3 SAI AU	1912130000	G.11

L

LPD350 4-20mA/0-100.0	7940010163	F.21
LPD450F 4-20mA	7940010236	F.23

M

MCZ CCC 0-20mA/0-20mA	8411190000	C.30
MCZ CCC 0-20mA/0-20mA	8411190000	C.32
MCZ CFC 0-20mA	8461480000	C.30
MCZ CFC 0-20mA	8461480000	C.34
MCZ PT100/3 CLP 0...100C	8425720000	C.30
MCZ PT100/3 CLP 0...100C	8425720000	C.33
MCZ PT100/3 CLP 0...120C	8483680000	C.30
MCZ PT100/3 CLP 0...120C	8483680000	C.33
MCZ PT100/3 CLP 0...150C	8604420000	C.30
MCZ PT100/3 CLP 0...150C	8604420000	C.33
MCZ PT100/3 CLP 0...200C	8473010000	C.30
MCZ PT100/3 CLP 0...200C	8473010000	C.33
MCZ PT100/3 CLP 0...300C	8473020000	C.30
MCZ PT100/3 CLP 0...300C	8473020000	C.33
MCZ PT100/3 CLP -40C...100C	8604430000	C.30
MCZ PT100/3 CLP -40C...100C	8604430000	C.33
MCZ PT100/3 CLP -50C...+150C	8473000000	C.30
MCZ PT100/3 CLP -50C...+150C	8473000000	C.33
MCZ SC 0-10V	8260280000	C.30
MCZ SC 0-10V	8260280000	C.35
MCZ SC 0-20MA	8227350000	C.30

Type	Order No.	Page
------	-----------	------

MCZ SC 0-20MA	8227350000	C.35
MCZ VFC 0-10V	8461470000	C.30
MCZ VFC 0-10V	8461470000	C.34
MF 5/7.5 MC NE WS	1877680000	G.11

P

P275	7940010202	G.17
PAS CMR 0.5...2.5 A DC	8742610000	E.6
PAS CMR 2.0...5.0 A DC	8742620000	E.6
PAS CMR 4.5...10 A DC	8742630000	E.7
PMX400HZX	7940015595	F.15
PMX400HZX RO/AO	7940011979	F.15
PMX400TMP	7940017862	F.14
PMX420	7940018956	F.11
PMX420Plus	7940018957	F.10
PORTACAL 1000EU	1439640000	G.15
PTX800A 4-20mA	7940010243	F.7
PTX800A 4-20mA/RO/AO	7940014374	F.7
PTX800D	7940011133	F.6
PTX800D RO/AO	7940012323	F.6

S

SET CH20M BUS 250MM TS 35X15	1335150000	C.27
SET CH20M BUS 250MM TS 35X15	1335150000	D.15
SET CH20M BUS 250MM TS 35X15	1335150000	G.7
SET CH20M BUS 250MM TS 35X7.5	1335140000	C.27
SET CH20M BUS 250MM TS 35X7.5	1335140000	D.15
SET CH20M BUS 250MM TS 35X7.5	1335140000	G.7

T

TS 35X15/LL 1M/ST/ZN	0236510000	C.27
TS 35X15/LL 1M/ST/ZN	0236510000	D.15
TS 35X15/LL 1M/ST/ZN	0236510000	G.7
TS 35X7.5/LL 1M/ST/ZN	0514510000	C.27
TS 35X7.5/LL 1M/ST/ZN	0514510000	D.15
TS 35X7.5/LL 1M/ST/ZN	0514510000	G.7

W

WAS1 CMA 1/5/10A ac	8523400000	D.72
WAS1 CMA LP 1/5/10A ac	8528650000	D.72
WAS1 CMA LP 1/5/10A EX	8975590000	D.73
WAS2 CMR 1/5/10A ac	8516560000	E.5
WAS2 VMA V ac	8581220000	D.74
WAS2 VMR 3ph	8705630000	E.9
WAS4 CCC DC 4-20/0-20MA	8445010000	D.54
WAS4 CCC DC 4-20/4-20MA	8444980000	D.54
WAS4 CVC DC 4-20/0-10V	8445040000	D.55
WAS4 PRO Freq	8581180000	D.71
WAS5 CCC 0-20/4-20mA	8540250000	D.48
WAS5 CCC 0-20/0-20mA	8540180000	D.48
WAS5 CCC 20LP	8581160000	D.56
WAS5 CCC 20LP EX	8975640000	D.57
WAS5 CCC 4-20/0-20MA	8540200000	D.50
WAS5 CCC HF 0-20/0-20MA	8447160000	D.44
WAS5 CCC HF 4-20/0-20MA	8447250000	D.45
WAS5 CCC LP 0-20/0-20mA	8444950000	D.59
WAS5 CCC LP 0-20/0-20mA	8463580000	D.59
WAS5 CVC 0-20mA/0-10V	8540270000	D.49
WAS5 CVC 4-20mA/0-10V	8540230000	D.50
WAS5 CVC HF 0-20/0-10V	8447220000	D.44
WAS5 CVC HF 4-20/0-10V	8447280000	D.45
WAS5 DC/Alarm	8543820000	E.4
WAS5 OLP	8543720000	D.58

Type	Order No.	Page
WAZ5 VVC 0-10V/0-10V	8540340000	0.52
WAZ5 VVC HF 0-10/0-10V	8447390000	0.47
WAZ6 TTA	8939690000	0.42
WAZ6 TTA EX	8964320000	0.43
WDS2 RS232/RS485/422	8615700000	0.77
WDS2 RS232/TTY	8615690000	0.78
WS 10/5 MC NE WS	1635000000	6.12
WS 10/6 MC NE WS	1828450000	6.12
WS 10/6 MC NE WS	1828450000	6.12
WS 15/5 MC NE WS	1609880000	6.12
WTS4 THERMO	8432300000	0.69
WT24 PT100/2 C 0/4-20mA	8432220000	0.67
WT24 PT100/2 V 0-10V	8432190000	0.67
WT24 PT100/3 C 0/4-20mA	8432160000	0.66
WT24 PT100/3 V 0-10V	8432130000	0.66
WT24 PT100/4 C 0/4-20mA	8432280000	0.65
WT24 PT100/4 V 0-10V	8432250000	0.65
WT24 THERMO	8432310000	0.69

Z

ZDV 2.5N/2 BL	1717990000	6.12
ZDV 2.5N/2 GE	1693800000	6.12
ZDV 2.5N/2 RT	1717900000	6.12
ZDV 2.5N/2 SW	1718080000	6.12
ZDV 4N/10 GE	1758260000	6.12
ZDV 4N/2 GE	1758250000	6.12
ZDV 4N/3 GE	1762630000	6.12
ZDV 4N/4 GE	1762620000	6.12

Order No.	Type	Page
-----------	------	------

1060000000

1067250000	ACT20P-BRIDGE-S	D.18
1067250000	ACT20P-BRIDGE-S	D.37

1080000000

1082540000	ESG 6.6/20 BHZ 5.00/04	G.10
1086040000	BHZ 5.00/02/90LH BK/BK PRT 41	G.10
1086130000	BHZ 5.00/04/90LH BK/BK PRT 11	G.10
1086140000	BHZ 5.00/04/90LH BK/BK PRT 21	G.10
1086150000	BHZ 5.00/04/90LH BK/BK PRT 31	G.10
1086160000	BHZ 5.00/04/90LH BK/BK PRT 41	G.10
1086170000	BHZ 5.00/04/90LH BK/BK PRT 51	G.10
1086180000	BHZ 5.00/04/90LH BK/BK PRT 61	G.10
1086190000	BHZ 5.00/04/90LH BK/BK PRT 15	G.10
1086200000	BHZ 5.00/04/90LH BK/BK PRT 25	G.10
1086210000	BHZ 5.00/04/90LH BK/BK PRT 35	G.10
1086220000	BHZ 5.00/04/90LH BK/BK PRT 45	G.10
1086230000	BHZ 5.00/04/90LH BK/BK PRT 55	G.10
1086240000	BHZ 5.00/04/90LH BK/BK PRT 65	G.10
1086250000	BHZ 5.00/02/90LH BK/BL PRT 11	G.10
1086260000	BHZ 5.00/02/90LH BK/BL PRT 21	G.10
1086370000	BHZ 5.00/04/90LH BK/BL PRT 11	G.10
1086380000	BHZ 5.00/04/90LH BK/BL PRT 21	G.10
1086390000	BHZ 5.00/04/90LH BK/BL PRT 31	G.10
1086400000	BHZ 5.00/04/90LH BK/BL PRT 41	G.10
1086410000	BHZ 5.00/04/90LH BK/BL PRT 51	G.10
1086420000	BHZ 5.00/04/90LH BK/BL PRT 61	G.10
1086430000	BHZ 5.00/04/90LH BK/BL PRT 15	G.10
1086440000	BHZ 5.00/04/90LH BK/BL PRT 25	G.10
1086450000	BHZ 5.00/04/90LH BK/BL PRT 35	G.10
1086460000	BHZ 5.00/04/90LH BK/BL PRT 45	G.10
1086470000	BHZ 5.00/04/90LH BK/BL PRT 55	G.10
1086480000	BHZ 5.00/04/90LH BK/BL PRT 65	G.10

1160000000

1160640000	ACT20X-CJC-HT1-S PRT 11	G.10
1160650000	ACT20X-CJC-HT1-S PRT 21	G.10

1170000000

1175980000	ACT20M-CI-CO-S	C.13
1175990000	ACT20M-CI-2CO-S	C.10
1176000000	ACT20M-AI-AD-S	C.14
1176010000	ACT20M-AI-AD-E-S	C.15
1176020000	ACT20M-AI-2AG-S	C.11
1176030000	ACT20M-UI-AD-S	C.17
1176040000	ACT20M-CI-CO-OLP-S	C.19
1176050000	ACT20M-2CI-2CO-OLP-S	C.19
1176070000	ACT20M-CI-CO-ILP-S	C.18
1176080000	ACT20M-2CI-2CO-ILP-S	C.18

1190000000

1193160000	CH20M BUS-AP LI TS 35X7.5 & amp; 15	C.27
1193160000	CH20M BUS-AP LI TS 35X7.5 & amp; 15	D.15
1193160000	CH20M BUS-AP LI TS 35X7.5 & amp; 15	G.7
1193170000	CH20M BUS-AP RE TS 35X7.5 & 15	C.27
1193170000	CH20M BUS-AP RE TS 35X7.5 & 15	D.15
1193170000	CH20M BUS-AP RE TS 35X7.5 & 15	G.7

1240000000

1248150000	CH20M BUS-PROFIL TS 35X7.5/250	C.27
1248150000	CH20M BUS-PROFIL TS 35X7.5/250	D.15
1248150000	CH20M BUS-PROFIL TS 35X7.5/250	G.7
1248160000	CH20M BUS-PROFIL TS 35X7.5/500	C.27
1248160000	CH20M BUS-PROFIL TS 35X7.5/500	D.15
1248160000	CH20M BUS-PROFIL TS 35X7.5/500	G.7
1248170000	CH20M BUS-PROFIL TS 35X7.5/750	C.27
1248170000	CH20M BUS-PROFIL TS 35X7.5/750	D.15
1248170000	CH20M BUS-PROFIL TS 35X7.5/750	G.7
1248180000	CH20M BUS-PROFIL TS 35X15/250	C.27
1248180000	CH20M BUS-PROFIL TS 35X15/250	D.15
1248180000	CH20M BUS-PROFIL TS 35X15/250	G.7
1248190000	CH20M BUS-PROFIL TS 35X15/500	C.27
1248190000	CH20M BUS-PROFIL TS 35X15/500	D.15
1248190000	CH20M BUS-PROFIL TS 35X15/500	G.7
1248210000	CH20M BUS-PROFIL TS 35X15/750	C.27
1248210000	CH20M BUS-PROFIL TS 35X15/750	D.15
1248210000	CH20M BUS-PROFIL TS 35X15/750	G.7
1248220000	CH20M BUS 4.50/05 AU/250	C.27
1248220000	CH20M BUS 4.50/05 AU/250	D.15
1248220000	CH20M BUS 4.50/05 AU/250	G.7
1248230000	CH20M BUS 4.50/05 AU/500	C.27
1248230000	CH20M BUS 4.50/05 AU/500	D.15
1248230000	CH20M BUS 4.50/05 AU/500	G.7
1248240000	CH20M BUS 4.50/05 AU/750	C.27
1248240000	CH20M BUS 4.50/05 AU/750	D.15
1248240000	CH20M BUS 4.50/05 AU/750	G.7
1248250000	CH20M BUS-ADP TS 35/250	C.27
1248250000	CH20M BUS-ADP TS 35/250	D.15
1248250000	CH20M BUS-ADP TS 35/250	G.7
1248260000	CH20M BUS-ADP TS 35/500	C.27
1248260000	CH20M BUS-ADP TS 35/500	D.15
1248260000	CH20M BUS-ADP TS 35/500	G.7
1248270000	CH20M BUS-ADP TS 35/750	C.27

Order No.	Type	Page
-----------	------	------

1248270000	CH20M BUS-ADP TS 35/750	D.15
1248270000	CH20M BUS-ADP TS 35/750	G.7

1280000000

1282490000	ACT20-FEED-IN-BASIC-S	C.29
1282490000	ACT20-FEED-IN-BASIC-S	G.9

1310000000

1318220000	ACT20X-HUI-SA0-LP-S	B.15
------------	---------------------	------

1330000000

1334490000	ACT20C-AI-AD-MTCP	D.7
1335140000	SET CH20M BUS 250MM TS 35X7.5	C.27
1335140000	SET CH20M BUS 250MM TS 35X7.5	D.15
1335140000	SET CH20M BUS 250MM TS 35X7.5	G.7
1335150000	SET CH20M BUS 250MM TS 35X15	C.27
1335150000	SET CH20M BUS 250MM TS 35X15	D.15
1335150000	SET CH20M BUS 250MM TS 35X15	G.7

1370000000

1375450000	ACT20M-BAI-AG-S	C.16
1375470000	ACT20M-BAI-2AD-S	C.12
1375480000	ACT20M-TCI-AD-S	C.24
1375500000	ACT20M-TCI-AD-E-S	C.25
1375510000	ACT20M-RTI-AD-S	C.22
1375520000	ACT20M-RTI-AD-E-S	C.23

1430000000

1435590000	ACT20M-RTCI-CO-OLP-S	C.20
1435610000	ACT20M-RTI-CO-EOLP-S	C.21
1439640000	PORTACAL 1000EU	G.15

1450000000

1453210000	ACT20P-UI-AD-DO-LP-S	D.18
1453210000	ACT20P-UI-AD-DO-LP-S	D.23

1470000000

1477420000	ACT20P-AI-AD-DC-S	D.18
1477420000	ACT20P-AI-AD-DC-S	D.25

1480000000

1481970000	ACT20P-PRO DCDC II-S	D.18
1481970000	ACT20P-PRO DCDC II-S	D.21

1510000000

1510240000	ACT20C-CMT-10-AG-RC-S	D.12
1510340000	ACT20C-LBT-10	D.13
1510370000	ACT20C-GTW-100-MTCP-S	D.11
1510390000	ACT20P-CMT-60-RC-S	D.33
1510420000	ACT20C-CMT-60-AG-RC-S	D.12
1510440000	ACT20P-CMT-60-AG-RC-S	D.18
1510440000	ACT20P-CMT-60-AG-RC-S	D.33
1510470000	ACT20P-CMT-10-AG-RC-S	D.18
1510470000	ACT20P-CMT-10-AG-RC-S	D.33
1510540000	ACT20P-CMT-30-AG-RC-S	D.18
1510540000	ACT20P-CMT-30-AG-RC-S	D.33

1520000000

1526460000	BLZ 5.08/02/180 SN OR BK	G.13
------------	--------------------------	------

1600000000

1609880000	WS 15/5 MC NE WS	G.12
1635000000	WS 10/5 MC NE WS	G.12
1693800000	ZUV 2.5N/2 GE	G.12

1710000000

1717900000	ZUV 2.5N/2 RT	G.12
1717900000	ZUV 2.5N/2 BL	G.12
1718080000	ZUV 2.5N/2 SW	G.12

1750000000

1758250000	ZUV 4N/2 GE	G.12
1758260000	ZUV 4N/10 GE	G.12

1760000000

1762620000	ZUV 4N/4 GE	G.12
1762630000	ZUV 4N/3 GE	G.12

1820000000

1828450000	WS 10/6 MC NE WS	G.12
1828450000	WS 10/6 MC NE WS	G.12

Order No.	Type	Page
-----------	------	------

1870000000

1877680000	MF 5/7.5 MC NE WS	G.11
------------	-------------------	------

1910000000

1912130000	ESG 8/13.5/43.3 SAI AU	G.10
1912130000	ESG 8/13.5/43.3 SAI AU	G.11

2240000000

2242030000	BLZ 5.08/03/180 SN OR PRT	G.13
2242050000	BLZ 5.08/03/180 SN OR PRT	G.13
2242060000	BLZ 5.08/03/180 SN OR PRT	G.13
2242070000	BLZ 5.08/03/180 SN OR PRT	G.13
2246070000	BLZ 5.08/02/180 SN OR PRT	G.13
2246080000	BLZ 5.08/02/180 SN OR PRT	G.13
2246090000	BLZ 5.08/02/180 SN OR PRT	G.13
2246100000	BLZ 5.08/02/180 SN OR PRT	G.13

7760000000

7760054114	ACT20P-CI-CO	D.18
7760054114	ACT20P-CI-CO	D.27
7760054115	ACT20P-CI-2CO	D.18
7760054115	ACT20P-CI-2CO	D.26
7760054117	ACT20P-2CI-2CO-12	D.18
7760054117	ACT20P-2CI-2CO-12	D.28

7940000000

7940010163	LPD350 4-20mA/0-100.0	F.21
7940010185	DI350 4-20mA/0-100.0	F.19
7940010202	P275	G.17
7940010236	LPD450F 4-20mA	F.23
7940010243	PTX800A 4-20mA	F.7
7940011133	PTX800D	F.8
7940011570	DI350 0-10V/0-100.0	F.19
7940011895	AMS400A 4-20mA/AO	F.17
7940011979	PMX400HZX RO/AO	F.15
7940012323	PTX800D RO/AO	F.6
7940014374	PTX800A 4-20mA/RO/AO	F.7
7940015595	PMX400HZX	F.15
7940017862	PMX400TMP	F.14
7940018956	PMX420	F.11
7940018957	PMX420Plus	F.10
7940045760	ACT20P-UI-2RCD-DC-S	D.18
7940045760	ACT20P-UI-2RCD-DC-S	D.31

8220000000

8227350000	MCZ SC 0-20MA	C.30
8227350000	MCZ SC 0-20MA	C.35

8260000000

8260280000	MCZ SC 0-10V	C.30
8260280000	MCZ SC 0-10V	C.35

8380000000

8389030000	AP MCZ1.5	G.12
------------	-----------	------

8410000000

Order No.	Type	Page
8447340000	WASS VCC HF 0-10/4-20mA	0.46
8447370000	WASS VVC HF 0-10/0-10V	0.47
8447380000	WAZ5 VVC HF 0-10/0-10V	0.47

8460000000

8461470000	MCZ VFC 0-10V	C.30
8461470000	MCZ VFC 0-10V	C.34
8461480000	MCZ CFC 0-20MA	C.30
8461480000	MCZ CFC 0-20MA	C.34
8463580000	WASS CCC LP 0-20/0-20mA	0.59
8463590000	WAZ5 CCC LP 0-20/0-20mA	0.59

8470000000

8473000000	MCZ PT100/3 CLP -50C...+150C	C.30
8473000000	MCZ PT100/3 CLP -50C...+150C	C.33
8473010000	MCZ PT100/3 CLP 0...200C	C.30
8473010000	MCZ PT100/3 CLP 0...200C	C.33
8473020000	MCZ PT100/3 CLP 0...300C	C.30
8473020000	MCZ PT100/3 CLP 0...300C	C.33

8480000000

8483680000	MCZ PT100/3 CLP 0...120C	C.30
8483680000	MCZ PT100/3 CLP 0...120C	C.33

8510000000

8516560000	WAS2 CMR 1/5/10A ac	E.5
8516570000	WAZ2 CMR 1/5/10A ac	E.5

8520000000

8523400000	WAS1 CMA 1/5/10A ac	0.72
8523410000	WAZ1 CMA 1/5/10A ac	0.72
8528650000	WAS1 CMA LP 1/5/10A ac	0.72
8528660000	WAZ1 CMA LP 1/5/10A ac	0.72

8540000000

8540180000	WAS5 CCC 0-20/0-20mA	0.48
8540190000	WAZ5 CCC 0-20/0-20mA	0.48
8540200000	WAS5 CCC 4-20/0-20MA	0.50
8540230000	WAS5 CVC 4-20mA/0-10V	0.50
8540250000	WAS5 CCC 0-20/4-20mA	0.48
8540270000	WAS5 CVC 0-20mA/0-10V	0.49
8540290000	WAS5 VCC 0-10V/4-20MA	0.51
8540300000	WAZ5 VCC 0-10V/4-20MA	0.51
8540310000	WAS5 VCC 0-10V/0-20MA	0.51
8540320000	WAZ5 VCC 0-10V/0-20MA	0.51
8540330000	WAS5 VVC 0-10V/0-10V	0.52
8540340000	WAZ5 VVC 0-10V/0-10V	0.52
8543720000	WAS5 OLP	0.58
8543730000	WAZ5 OLP	0.58
8543820000	WAS5 DC/Alarm	E.4
8543880000	WAZ5 DC/Alarm	E.4

8560000000

8560700000	WAS5 PRO RTD	0.60
8560710000	WAZ5 PRO RTD	0.60
8560720000	WAS5 PRO Thermo	0.68
8560730000	WAZ5 PRO Thermo	0.68
8561610000	WAS5 VVC HF +/-10V/+/-10V	0.47

8580000000

8581160000	WAS5 CCC 20LP	0.56
8581170000	WAZ5 CCC 20LP	0.56
8581180000	WAS4 PRO Freq	0.71
8581190000	WAZ4 PRO Freq	0.71
8581220000	WAS2 VMA V ac	0.74
8581230000	WAZ2 VMA V ac	0.74

8600000000

8604420000	MCZ PT100/3 CLP 0...150C	C.30
8604420000	MCZ PT100/3 CLP 0...150C	C.33
8604430000	MCZ PT100/3 CLP -40C...100C	C.30
8604430000	MCZ PT100/3 CLP -40C...100C	C.33

8610000000

8615690000	WDS2 RS232/TTY	0.78
8615700000	WDS2 RS232/RS485/422	0.77

8630000000

8638950000	WAS5 PRO RTD Cu	0.64
------------	-----------------	------

8670000000

8679490000	WAS5 PRO RTD 1000	0.62
------------	-------------------	------

8700000000

8705630000	WAS2 VMR 3ph	E.9
8705640000	WAS5 VMR 1ph	E.8

Order No.	Type	Page
8742610000	PAS CMR 0,5...2,5 A DC	E.6
8742620000	PAS CMR 2,0...5,0 A DC	E.6
8742630000	PAS CMR 4,5...10 A DC	E.7

8930000000

8939670000	WAS6 TTA	0.42
8939680000	WAZ6 TTA	0.42

8960000000

8964310000	WAS6 TTA EX	0.43
8964320000	WAZ6 TTA EX	0.43
8965340000	ACT20X-HDI-SDO-RND-S	B.17
8965350000	ACT20X-HDI-SDO-RNC-S	B.17
8965360000	ACT20X-HDI-SDO-S	B.19
8965370000	ACT20X-2HDI-2SDO-RND-S	B.17
8965380000	ACT20X-2HDI-2SDO-RNC-S	B.17
8965390000	ACT20X-2HDI-2SDO-S	B.19
8965400000	ACT20X-SDI-HDO-L-S	B.21
8965410000	ACT20X-SDI-HDO-H-S	B.23
8965420000	ACT20X-2SDI-2HDO-S	B.21
8965430000	ACT20X-HAI-SAO-S	B.7
8965440000	ACT20X-2HAI-2SAO-S	B.7
8965450000	ACT20X-SAI-HAO-S	B.9
8965460000	ACT20X-2SAI-2HAO-S	B.9
8965470000	ACT20X-HTI-SAO-S	B.11
8965480000	ACT20X-2HTI-2SAO-S	B.11
8965490000	ACT20X-HUI-SAO-S	B.13
8965500000	ACT20-FEED-IN-PRO-S	C.29
8965500000	ACT20-FEED-IN-PRO-S	G.9

8970000000

8975590000	WAS1 CMA LP 1/5/10A EX	D.73
8975640000	WAS5 CCC 20LP EX	D.57
8978580000	CBX200 USB	G.4

0230000000

0238510000	TS 35X15/LL 1M/ST/ZN	C.27
0238510000	TS 35X15/LL 1M/ST/ZN	D.15
0238510000	TS 35X15/LL 1M/ST/ZN	G.7

0510000000

0514510000	TS 35X7 5/LL 1M/ST/ZN	C.27
0514510000	TS 35X7 5/LL 1M/ST/ZN	D.15
0514510000	TS 35X7 5/LL 1M/ST/ZN	G.7

Index / Order No.

X

We cannot guarantee that there are no mistakes in the publications or software provided by us to the customer for the purpose of making orders. We try our best to quickly correct errors in our printed media.

X

All orders are based on our general terms of delivery, which can be reviewed on the websites of our group companies where you place your order. On demand we can also send the general terms of delivery to you.

Weidmüller – Your partner in Industrial Connectivity

As experienced experts we support our customers and partners around the world with products, solutions and services in the industrial environment of power, signal and data. We are at home in their industries and markets and know the technological challenges of tomorrow. We are therefore continuously developing innovative, sustainable and useful solutions for their individual needs. Together we set standards in Industrial Connectivity.

Weidmüller Interface GmbH & Co. KG
Klingenbergstraße 16
32758 Detmold, Germany
T +49 5231 14-0
F +49 5231 14-292083
info@weidmueller.com
www.weidmueller.com

Your local Weidmüller partner can
be found on our website:
www.weidmueller.com/countries

Made in Germany



Order number: 2028820000/11/2015/SMDM

X-ON Electronics

Largest Supplier of Electrical and Electronic Components

Click to view similar products for [Measuring Tools](#) category:

Click to view products by [Weidmuller](#) manufacturer:

Other Similar products are found below :

[G336](#) [M225203-01](#) [G426](#) [G1333](#) [G1327](#) [G1154](#) [G1150](#) [G1152](#) [G1157](#) [G1153](#) [G1155](#) [G1009](#) [1051-03](#) [121010D](#) [121050D](#) [25541](#) [8255](#)
[NF-221200130](#) [20323](#) [20329](#) [20363](#) [20365](#) [20515](#) [20516](#) [G800](#) [G1229](#) [5205000](#) [5206000](#) [5223000](#) [6921000](#) [YT-30061](#) [W002900](#)
[W061008](#) [W061009](#) [W061010](#) [W062004](#) [W066005](#) [W066006](#) [15225](#) [15228](#) [16135](#) [16456](#) [17215](#) [17218](#) [17221](#) [17670](#) [17672](#) [17677](#)
[17953](#) [18115](#)