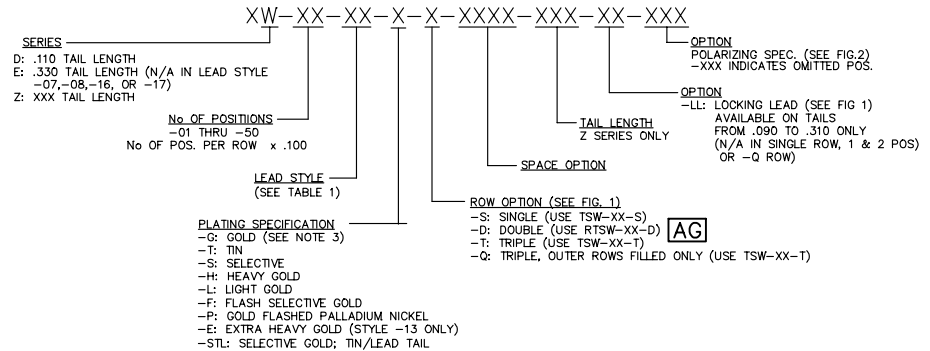

TABLE 1			
LEAD STYLE		TERMINAL	'L' OVERALL LENGTH (REF)
SERIES D&Z	SERIES E		
07	N/A	T-1S6-07-X-2	.430
08	N/A	T-1S6-08-X-2	.530
09	09	T-1S6-09-X-2	.730
10	10	T-1S6-10-X-2	.830
11	11	T-1S6-11-X-2	.930
12	12	T-1S6-12-X-2	1.030
13	13	T-1S6-13-X-2	1.230
14	14	T-1S6-14-X-2	1.430
15	15	T-1S6-15-X-2	.630
16	N/A	T-1S6-16-X-2	.445
17	N/A	T-1S6-17-X-2	.480
19	19	T-1S6-19-X-2	1.330
20	20	T-1S6-20-X-2	1.130

UNLESS OTHERWISE NOTED TOLERANCES ARE:

ONE PLACE DECIMALS ±.1	THREE PLACE DECIMALS ± .005	ANGLES ± 2°
TWO PLACE DECIMALS ±.01	FOUR PLACE DECIMALS ± .0020	

TITLE: **LOW COST BOARD SPACERS** DWG NO: XW-XX-XX-X-X-XXXX-XXX-XX-XXX  
SHEET 1 OF 2



DO NOT SCALE FROM THIS PRINT

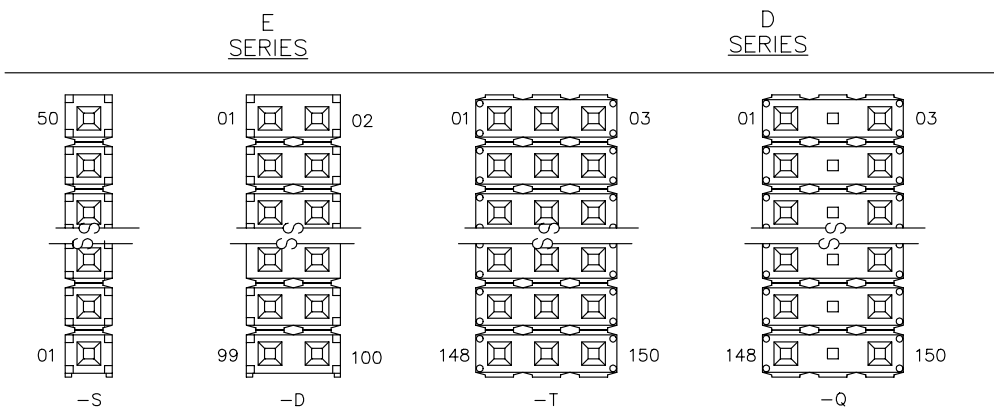
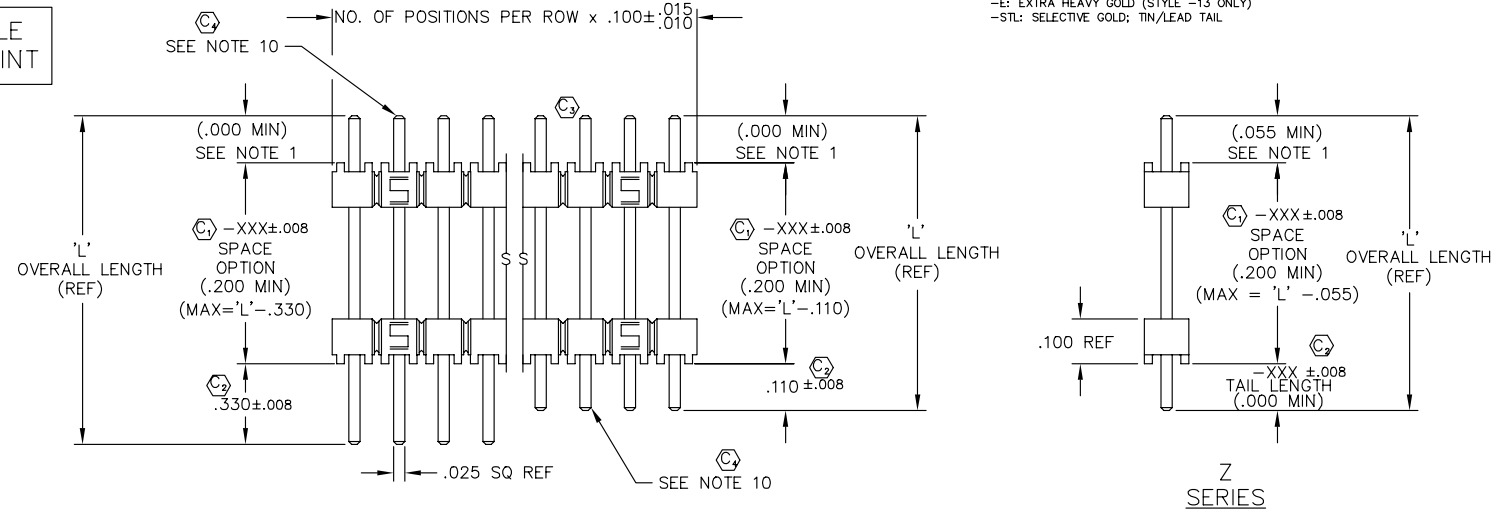

- NOTES:
- HEIGHT VARIATION BETWEEN ANY TWO PINS SHALL BE .010 MAX.
  - S PLATING: PLATED AREA WILL BE ON THE LONGER TAIL.
  - G PLATING: HEAVY GOLD ON LONGER TAIL
  - L PLATING: GOLD ON LONGER TAIL
  - H PLATING: HEAVY GOLD ON LONGER TAIL
  - F PLATING: FLASH SELECTIVE GOLD ON LONGER TAIL
  - P PLATING: GOLD FLASHED PALLADIUM NICKEL ON LONGER TAIL
  - E PLATING: EXTRA HEAVY GOLD ON LONGER TAIL
  - (C) REPRESENTS A CRITICAL DIMENSION.
  - F, -S, -L, -P GOLD TO BE ON LONGER TAIL.  
 -G, -H, -E, HEAVY GOLD TO BE ON LONGER TAIL.
  - CRIMPED TAILS OF .090 TO BE TOLERANCED +.008/-.000.
  - TSW-50-D TO BE USED IF RTSW-50-D IS NOT AVAILABLE

**PROPRIETARY NOTE**  
 THIS DOCUMENT CONTAINS INFORMATION CONFIDENTIAL AND PROPRIETARY TO SAMTEC INC AND SHALL NOT BE REPRODUCED OR TRANSFERRED TO OTHER DOCUMENTS OR DISCLOSED TO OTHERS OR USED FOR ANY PURPOSE OTHER THAN THAT FOR WHICH IT WAS OBTAINED WITHOUT THE EXPRESSED WRITTEN CONSENT OF SAMTEC INC.

FIGURE 2  
 NUMBER POSITIONS WITH .330, .110, OR ZW TAIL DOWN

**MATERIAL:**  
 BODIES:  
 SINGLE & DOUBLE ROW STRAIGHT:  
 VALOX DR-48 or  
 DUPONT CRASTIN SK652FR  
 ALL OTHER BODY STYLES:  
 VALOX 420 SEC  
 GLASS FILLED POLYESTER  
 COLOR:BLACK  
 TERMINALS:  
 PHOSPHOR BRONZE, ALLOY  
 NO. 510, 3/4 HARD,  
 TENSILE RANGE 95-105 KSI

EXISPROD\ASSEMBLY\100  
 XW-ASM

**samtec**

520 PARK EAST BLVD. NEW ALBANY, INDIANA 47150  
 PHONE (812) 944-6733 P.O. BOX 1147  
 CODE 55322

MADE BY: WILLIAMS 8-13-84

XW-XX-XX-X-X-XXXX-XXX-XX-XXX  
 SHEET 1 OF 2

DIMENSIONS ARE IN INCHES		UNLESS OTHERWISE NOTED	TOLERANCES ARE:
ONE PLACE DECIMALS ±.1	THREE PLACE DECIMALS ± .005	ANGLES ± 2°	
TWO PLACE DECIMALS ±.01	FOUR PLACE DECIMALS ± .0020		

TITLE:  
**LOW COST BOARD SPACERS**

DWG NO:  
XW-XX-XX-X-X-XXXX-XXX-XX-XXX  
SHEET 2 OF 2

CRIMP SHORTER TAIL  
(OPPOSITE GOLD CONTACT AREA)

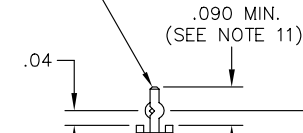

SEE CRIMP DETAIL

RTSW-XX-D

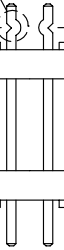

TSW-50-T

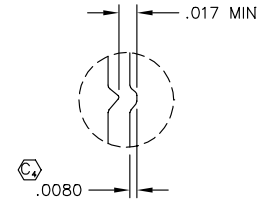
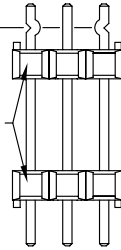

CRIMP DETAIL  
SCALE: 2x  
[TYP- ALL CRIMPS]

FIG. 1  
LOCKING LEAD OPTION

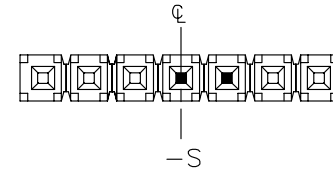
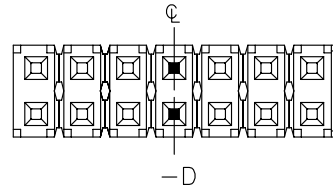
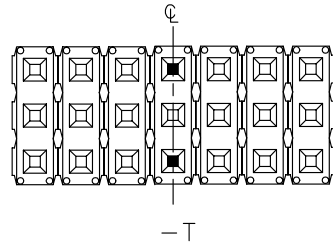

■ = CRIMP LOCATION  
ODD POSITIONS

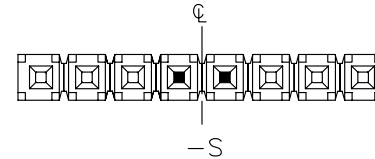
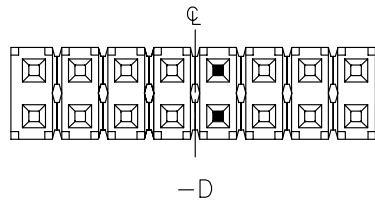
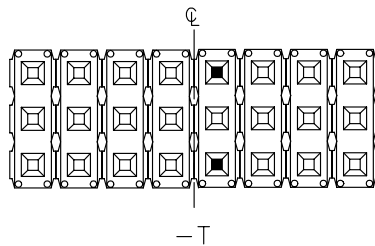

■ = CRIMP LOCATION  
EVEN POSITIONS

**PROPRIETARY NOTE**  
THIS DOCUMENT CONTAINS INFORMATION CONFIDENTIAL AND PROPRIETARY TO SAMTEC INC. AND SHALL NOT BE REPRODUCED OR TRANSFERRED TO OTHER DOCUMENTS OR DISCLOSED TO OTHERS OR USED FOR ANY PURPOSE OTHER THAN THAT FOR WHICH IT WAS OBTAINED WITHOUT THE EXPRESSED WRITTEN CONSENT OF SAMTEC INC.

**samtec**

EXISPROD\ASSEMBLY\100  
XW-ASM2

520 PARK EAST BLVD. NEW ALBANY, INDIANA 47150  
PHONE (812) 944-6733 P.O. BOX 1147  
CODE 55322

MADE BY: WILLIAMS 8-13-84

XW-XX-XX-X-X-XXXX-XXX-XX-XXX  
SHEET 2 OF 2

## X-ON Electronics

Largest Supplier of Electrical and Electronic Components

*Click to view similar products for [Headers & Wire Housings](#) category:*

*Click to view products by [Samtec](#) manufacturer:*

Other Similar products are found below :

[95000-104TRLF](#) [10135584-644402LF](#) [DF62W-EP2022PCA](#) [95000-106TRLF](#) [DF62W-2022SCA](#) [DF62W-EP2022PC](#) [2203348](#) [DF62W-2022SC](#) [1084018](#) [1029039](#) [1084017](#) [802-10-012-10-002000](#) [1112640](#) [1112639](#) [000-34000](#) [0009482033](#) [0009507031](#) [57102-S06-03LF](#) [57202-S52-04LF](#) [PCN6-15S-2.5E](#) [0039019024](#) [58102-G61-06LF](#) [582553-1](#) [0009485154](#) [0009508121](#) [0022285053](#) [0050291907](#) [018731A](#) [LY20-4P-DT1-P1E-BR](#) [02.125.8002.8](#) [60101931](#) [60598-1 \(Cut Strip\)](#) [M1625-3R/100](#) [61062-3](#) [61082-181009](#) [636-1427](#) [638009-1](#) [641938-9](#) [641991-4](#) [644168-1](#) [647662-1](#) [65039-019ELF](#) [65817-002LF](#) [65817-015LF](#) [65863-015LF](#) [66207-023LF](#) [67016-026LF](#) [67046-001LF](#) [67095-007LF](#) [67230-005LF](#)