

Description

The AP2125 series are 300mA, positive voltage regulator ICs fabricated by CMOS process.

Each of these ICs is equipped with a voltage reference, an error amplifier, a resistor network for setting output voltage, a chip enable circuit, a current limit circuit and OTSD (over temperature shut down) circuit to prevent the IC from over current and over temperature.

The AP2125 series have features of high ripple rejection, low dropout voltage, low noise, high output voltage accuracy and low current consumption which make them ideal for use in various battery-powered apparatus.

The AP2125 have 1.8V, 2.5V, 2.8V, 3.0V, 3.3V, 4.15V and 4.2V fixed voltage versions.

These ICs are available in tiny SC-70-5 packages as well as industry standard SOT-23-3 and SOT-23-5 packages.

Features

- Excellent Ripple Rejection: 70dB Typical (1.8V Version)
- Low Dropout Voltage: 65mV ($I_{OUT}=100mA$, 3.3V Version)
- Low Standby Current: 0.01 μA Typical
- Low Quiescent Current: 60 μA Typical
- Extremely Low Noise: 50 μV_{rms} Typical
- Maximum Output Current: 300mA (Min.)
- High Output Voltage Accuracy: $\pm 2\%$
- Compatible with Low ESR Ceramic Capacitor
- Excellent Line/Load Regulation
- **Totally Lead-Free & Fully RoHS Compliant (Notes 1 & 2)**
- **Halogen and Antimony Free. "Green" Device (Note 3)**

- Notes:
1. No purposely added lead. Fully EU Directive 2002/95/EC (RoHS) & 2011/65/EU (RoHS 2) compliant.
 2. See http://www.diodes.com/quality/lead_free.html for more information about Diodes Incorporated's definitions of Halogen- and Antimony-free, "Green" and Lead-free.
 3. Halogen- and Antimony-free "Green" products are defined as those which contain <900ppm bromine, <900ppm chlorine (<1500ppm total Br + Cl) and <1000ppm antimony compounds.

Pin Assignments

(Top View)

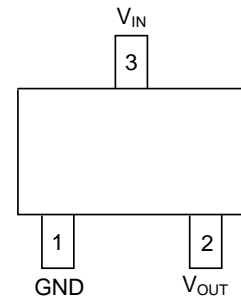

SOT-23-3

(Top View)

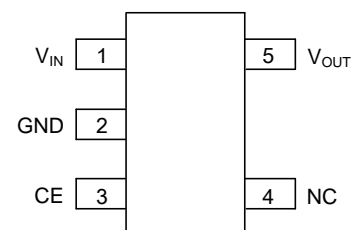

SOT-23-5/SC-70-5

Applications

- CDMA/GSM Cellular Handsets
- Battery-powered Equipments
- Laptops, Palmtops, Notebook Computers
- Hand-held Instruments
- PCMCIA Cards
- Portable Information Appliances

Typical Applications Circuit

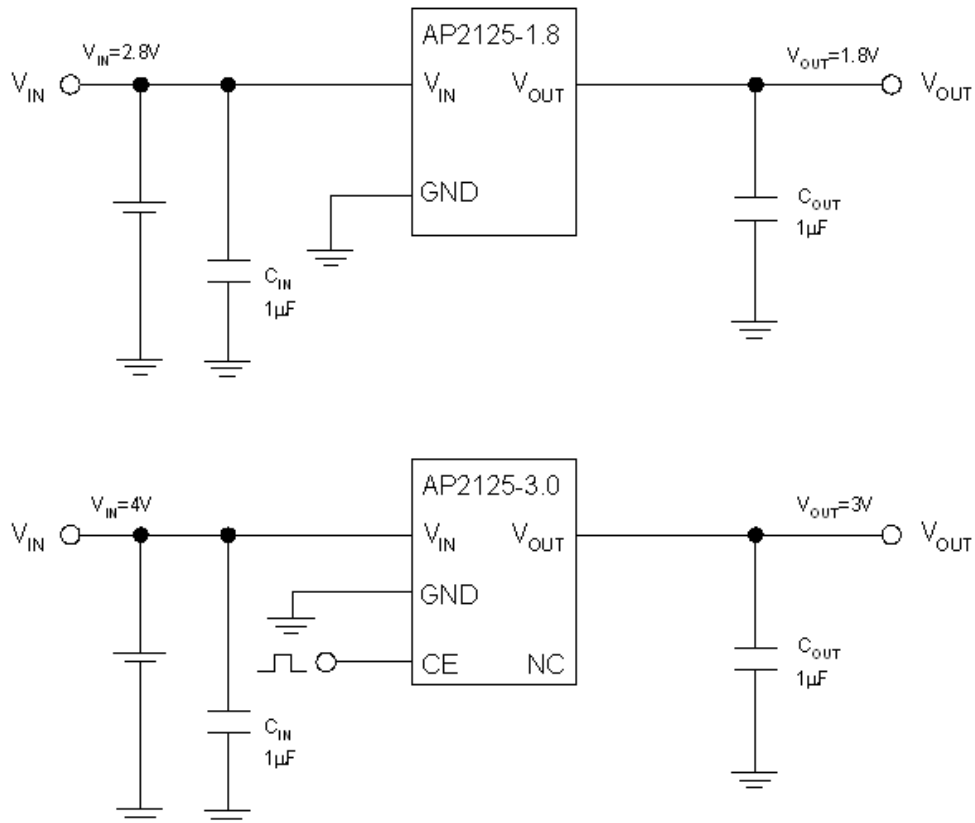

Pin Descriptions

| Pin Number | | Pin Name | Function |
|------------|------------------|------------------|---|
| SOT-23-3 | SOT-23-5/SC-70-5 | | |
| 3 | 1 | V _{IN} | Input voltage |
| 1 | 2 | GND | Ground |
| – | 3 | CE | Active high enable input pin. Logic high=enable, logic low = shutdown |
| – | 4 | NC | No connection |
| 2 | 5 | V _{OUT} | Regulated output voltage |

Functional Block Diagram

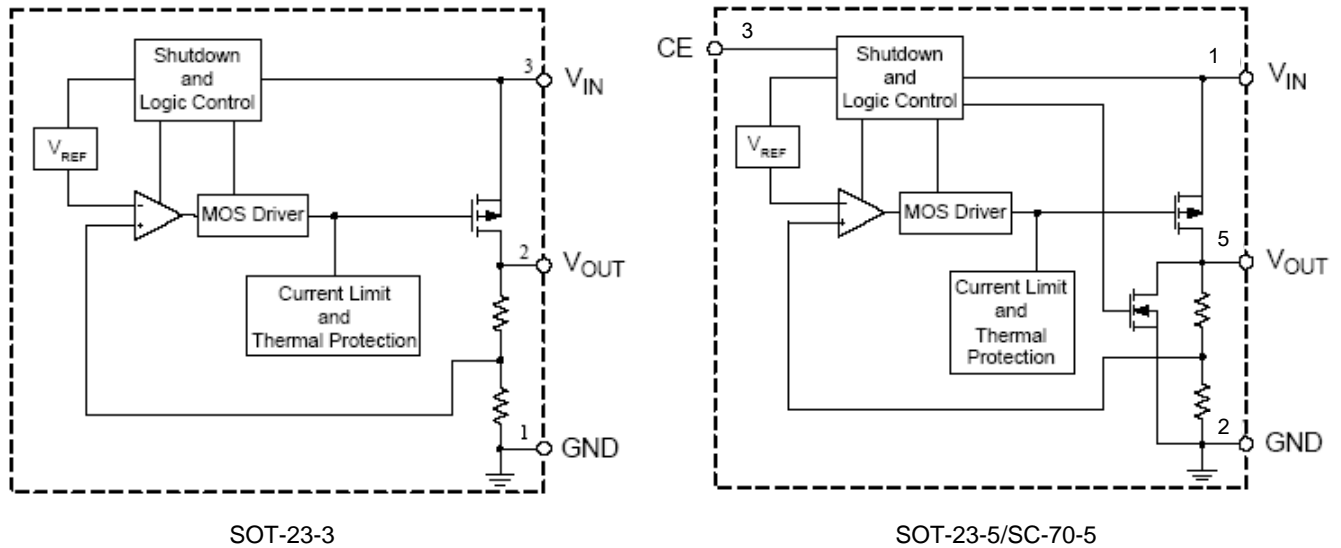

Absolute Maximum Ratings (Note 4)

| Symbol | Parameter | Value | Unit |
|---------------|-------------------------------------|------------------------|------|
| V_{IN} | Input Voltage | 6.5 | V |
| V_{CE} | Enable Input Voltage | -0.3 to $V_{IN} + 0.3$ | V |
| I_{OUT} | Output Current | 450 | mA |
| T_J | Junction Temperature | +150 | °C |
| T_{STG} | Storage Temperature Range | -65 to +150 | °C |
| T_{LEAD} | Lead Temperature (Soldering, 10sec) | +260 | °C |
| θ_{JA} | Thermal Resistance | SOT-23-3 | 200 |
| | | SOT-23-5 | 200 |
| | | SC-70-5 | 300 |
| ESD | ESD (Human Body Model) | 6000 | V |
| ESD | ESD (Machine Model) | 400 | V |

Note 4: Stresses greater than those listed under "Absolute Maximum Ratings" may cause permanent damage to the device. These are stress ratings only, and functional operation of the device at these or any other conditions beyond those indicated under "Recommended Operating Conditions" is not implied. Exposure to "Absolute Maximum Ratings" for extended periods may affect device reliability.

Recommended Operating Conditions

| Symbol | Parameter | Min | Max | Unit |
|----------|-------------------------------------|------------------|-----|------|
| V_{IN} | Input Voltage | $V_{OUT} + 0.5V$ | 6 | V |
| T_A | Operating Ambient Temperature Range | -40 | +85 | °C |

Electrical Characteristics

AP2125-1.8 Electrical Characteristics (@ $V_{IN} = 2.8V$, $T_A = +25^\circ C$, $C_{IN} = 1\mu F$, $C_{OUT} = 1\mu F$, **Bold** typeface applies over $-40^\circ C \leq T_J \leq +85^\circ C$, unless otherwise specified.)

| Symbol | Parameter | Conditions | Min | Typ | Max | Unit | |
|-------------------------------------|--|--|-------------|-----------------------------|-------|-----------------|----|
| V_{OUT} | Output Voltage | $V_{IN} = 2.8V$ $1mA \leq I_{OUT} \leq 30mA$ | 1.764 | 1.8 | 1.836 | V | |
| V_{IN} | Input Voltage | – | – | – | 6 | V | |
| $I_{OUT(MAX)}$ | Maximum Output Current | $V_{IN} - V_{OUT} = 1V$, $V_{OUT} = 1.76V$ | 300 | 360 | – | mA | |
| V_{RLOAD} | Load Regulation | $V_{IN} = 2.8V$ $1mA \leq I_{OUT} \leq 300mA$ | – | 6 | 15 | mV | |
| V_{RLINE} | Line Regulation | $2.8V \leq V_{IN} \leq 6V$ $I_{OUT} = 30mA$ | – | 1 | 15 | mV | |
| V_{DROP} | Dropout Voltage | $I_{OUT} = 10mA$ | – | 10 | 12 | mV | |
| | | $I_{OUT} = 100mA$ | – | 100 | 120 | | |
| | | $I_{OUT} = 300mA$ | – | 300 | 360 | | |
| I_Q | Quiescent Current | $V_{IN} = 2.8V$, $I_{OUT} = 0mA$ | – | 60 | 90 | μA | |
| I_{STD} | Standby Current | $V_{IN} = 2.8V$ V_{CE} in OFF mode | – | 0.01 | 1.0 | μA | |
| PSRR | Power Supply Rejection Ratio | Ripple 0.5Vp-p, $V_{IN} = 2.8V$ | $f = 100Hz$ | – | 70 | – | dB |
| | | | $f = 1KHz$ | – | 70 | – | dB |
| $(\Delta V_{OUT}/V_{OUT})/\Delta T$ | Output Voltage Temperature Coefficient | $I_{OUT} = 30mA$ | – | ± 100 | – | ppm/ $^\circ C$ | |
| I_{SHORT} | Short Current Limit | $V_{OUT} = 0V$ | – | 50 | – | mA | |
| V_{NOISE} | RMS Output Noise | $10Hz \leq f \leq 100kHz$ | – | 50 | – | μV_{rms} | |
| – | CE "High" Voltage | CE input voltage "High" | 1.5 | – | – | V | |
| – | CE "Low" Voltage | CE input voltage "Low" | – | – | 0.4 | V | |
| – | Thermal Shutdown | – | – | +160 | – | $^\circ C$ | |
| – | Thermal Shutdown Hysteresis | – | – | +25 | – | $^\circ C$ | |

Electrical Characteristics (Cont.)

AP2125-2.5 Electrical Characteristics (@ $V_{IN} = 3.5V$, $T_A = +25^{\circ}C$, $C_{IN} = 1\mu F$, $C_{OUT} = 1\mu F$, **Bold** typeface applies over $-40^{\circ}C \leq T_J \leq +85^{\circ}C$, unless otherwise specified.)

| Symbol | Parameter | Conditions | Min | Typ | Max | Unit | |
|-------------------------------------|--|--|-------------|-----------------------------|------|------------------|----|
| V_{OUT} | Output Voltage | $V_{IN} = 3.5V$ $1mA \leq I_{OUT} \leq 30mA$ | 2.45 | 2.5 | 2.55 | V | |
| V_{IN} | Input Voltage | – | – | – | 6 | V | |
| $I_{OUT(MAX)}$ | Maximum Output Current | $V_{IN} - V_{OUT} = 1V$, $V_{OUT} = 2.45V$ | 300 | 360 | – | mA | |
| V_{RLOAD} | Load Regulation | $V_{IN} = 3.5V$ $1mA \leq I_{OUT} \leq 300mA$ | – | 10 | 15 | mV | |
| V_{RLINE} | Line Regulation | $3.5V \leq V_{IN} \leq 6V$ $I_{OUT} = 30mA$ | – | 1 | 15 | mV | |
| V_{DROP} | Dropout Voltage | $I_{OUT} = 10mA$ | – | 6.5 | 10 | mV | |
| | | $I_{OUT} = 100mA$ | – | 65 | 100 | | |
| | | $I_{OUT} = 300mA$ | – | 200 | 300 | | |
| I_Q | Quiescent Current | $V_{IN} = 3.5V$, $I_{OUT} = 0mA$ | – | 60 | 90 | μA | |
| I_{STD} | Standby Current | $V_{IN} = 3.5V$ V_{CE} in OFF mode | – | 0.01 | 1.0 | μA | |
| PSRR | Power Supply Rejection Ratio | Ripple 0.5Vp-p, $V_{IN} = 3.5V$ | $f = 100Hz$ | – | 65 | – | dB |
| | | | $f = 1KHz$ | – | 65 | – | dB |
| $(\Delta V_{OUT}/V_{OUT})/\Delta T$ | Output Voltage Temperature Coefficient | $I_{OUT} = 30mA$ | – | ± 100 | – | ppm/ $^{\circ}C$ | |
| I_{SHORT} | Short Current Limit | $V_{OUT} = 0V$ | – | 50 | – | mA | |
| V_{NOISE} | RMS Output Noise | $10Hz \leq f \leq 100kHz$ | – | 50 | – | μV_{rms} | |
| – | CE "High" Voltage | CE input voltage "High" | 1.5 | – | – | V | |
| – | CE "Low" Voltage | CE input voltage "Low" | – | – | 0.4 | V | |
| – | Thermal Shutdown | – | – | +160 | – | $^{\circ}C$ | |
| – | Thermal Shutdown Hysteresis | – | – | +25 | – | $^{\circ}C$ | |

Electrical Characteristics (Cont.)

AP2125-2.8 Electrical Characteristics (@ $V_{IN} = 3.8V$, $T_A = +25^\circ C$, $C_{IN} = 1\mu F$, $C_{OUT} = 1\mu F$, **Bold** typeface applies over $-40^\circ C \leq T_J \leq +85^\circ C$, unless otherwise specified.)

| Symbol | Parameter | Conditions | Min | Typ | Max | Unit | |
|-------------------------------------|--|--|-------------|-----------------------------|-------|-----------------|----|
| V_{OUT} | Output Voltage | $V_{IN} = 3.8V$ $1mA \leq I_{OUT} \leq 30mA$ | 2.744 | 2.8 | 2.856 | V | |
| V_{IN} | Input Voltage | – | – | – | 6 | V | |
| $I_{OUT(MAX)}$ | Maximum Output Current | $V_{IN} - V_{OUT} = 1V$, $V_{OUT} = 2.74V$ | 300 | 360 | – | mA | |
| V_{RLOAD} | Load Regulation | $V_{IN} = 3.8V$ $1mA \leq I_{OUT} \leq 300mA$ | – | 11 | 15 | mV | |
| V_{RLINE} | Line Regulation | $3.8V \leq V_{IN} \leq 6V$ $I_{OUT} = 30mA$ | – | 1 | 15 | mV | |
| V_{DROP} | Dropout Voltage | $I_{OUT} = 10mA$ | – | 6.5 | 10 | mV | |
| | | $I_{OUT} = 100mA$ | – | 65 | 100 | | |
| | | $I_{OUT} = 300mA$ | – | 200 | 300 | | |
| I_Q | Quiescent Current | $V_{IN} = 3.8V$, $I_{OUT} = 0mA$ | – | 60 | 90 | μA | |
| I_{STD} | Standby Current | $V_{IN} = 3.8V$ V_{CE} in OFF mode | – | 0.01 | 1.0 | μA | |
| PSRR | Power Supply Rejection Ratio | Ripple 0.5Vp-p, $V_{IN} = 3.8V$ | $f = 100Hz$ | – | 65 | – | dB |
| | | | $f = 1KHz$ | – | 65 | – | dB |
| $(\Delta V_{OUT}/V_{OUT})/\Delta T$ | Output Voltage Temperature Coefficient | $I_{OUT} = 30mA$ | – | ± 100 | – | ppm/ $^\circ C$ | |
| I_{SHORT} | Short Current Limit | $V_{OUT} = 0V$ | – | 50 | – | mA | |
| V_{NOISE} | RMS Output Noise | $10Hz \leq f \leq 100kHz$ | – | 50 | – | μV_{rms} | |
| – | CE "High" Voltage | CE input voltage "High" | 1.5 | – | – | V | |
| – | CE "Low" Voltage | CE input voltage "Low" | – | – | 0.4 | V | |
| – | Thermal Shutdown | – | – | +160 | – | $^\circ C$ | |
| – | Thermal Shutdown Hysteresis | – | – | +25 | – | $^\circ C$ | |

Electrical Characteristics (Cont.)

AP2125-3.0 Electrical Characteristics (@ $V_{IN} = 4.0V$, $T_A = +25^\circ C$, $C_{IN} = 1\mu F$, $C_{OUT} = 1\mu F$, **Bold** typeface applies over $-40^\circ C \leq T_J \leq +85^\circ C$, unless otherwise specified.)

| Symbol | Parameter | Conditions | Min | Typ | Max | Unit | |
|-------------------------------------|--|--|-------------|-----------------------------|------|-----------------|----|
| V_{OUT} | Output Voltage | $V_{IN} = 4.0V$ $1mA \leq I_{OUT} \leq 30mA$ | 2.94 | 3.0 | 3.06 | V | |
| V_{IN} | Input Voltage | – | – | – | 6 | V | |
| $I_{OUT(MAX)}$ | Maximum Output Current | $V_{IN} - V_{OUT} = 1V$, $V_{OUT} = 2.94V$ | 300 | 360 | – | mA | |
| V_{RLOAD} | Load Regulation | $V_{IN} = 4.0V$ $1mA \leq I_{OUT} \leq 300mA$ | – | 12 | 15 | mV | |
| V_{RLINE} | Line Regulation | $4.0V \leq V_{IN} \leq 6V$ $I_{OUT} = 30mA$ | – | 1 | 15 | mV | |
| V_{DROP} | Dropout Voltage | $I_{OUT} = 10mA$ | – | 6.5 | 10 | mV | |
| | | $I_{OUT} = 100mA$ | – | 65 | 100 | | |
| | | $I_{OUT} = 300mA$ | – | 200 | 300 | | |
| I_Q | Quiescent Current | $V_{IN} = 4.0V$, $I_{OUT} = 0mA$ | – | 60 | 90 | μA | |
| I_{STD} | Standby Current | $V_{IN} = 4.0V$ V_{CE} in OFF mode | – | 0.01 | 1.0 | μA | |
| PSRR | Power Supply Rejection Ratio | Ripple 0.5Vp-p, $V_{IN} = 4.0V$ | $f = 100Hz$ | – | 65 | – | dB |
| | | | $f = 1KHz$ | – | 65 | – | dB |
| $(\Delta V_{OUT}/V_{OUT})/\Delta T$ | Output Voltage Temperature Coefficient | $I_{OUT} = 30mA$ | – | ± 100 | – | ppm/ $^\circ C$ | |
| I_{SHORT} | Short Current Limit | $V_{OUT} = 0V$ | – | 50 | – | mA | |
| V_{NOISE} | RMS Output Noise | $10Hz \leq f \leq 100kHz$ | – | 50 | – | μV_{rms} | |
| – | CE "High" Voltage | CE input voltage "High" | 1.5 | – | – | V | |
| – | CE "Low" Voltage | CE input voltage "Low" | – | – | 0.4 | V | |
| – | Thermal Shutdown | – | – | +160 | – | $^\circ C$ | |
| – | Thermal Shutdown Hysteresis | – | – | +25 | – | $^\circ C$ | |

Electrical Characteristics (Cont.)

AP2125-3.3 Electrical Characteristics (@ $V_{IN} = 4.3V$, $T_A = +25^\circ C$, $C_{IN} = 1\mu F$, $C_{OUT} = 1\mu F$, **Bold** typeface applies over $-40^\circ C \leq T_J \leq +85^\circ C$, unless otherwise specified.)

| Symbol | Parameter | Conditions | Min | Typ | Max | Unit | |
|-------------------------------------|--|--|-------------|-----------------------------|-------|-----------------|----|
| V_{OUT} | Output Voltage | $V_{IN} = 4.3V$ $1mA \leq I_{OUT} \leq 30mA$ | 3.234 | 3.3 | 3.366 | V | |
| V_{IN} | Input Voltage | – | – | – | 6 | V | |
| $I_{OUT(MAX)}$ | Maximum Output Current | $V_{IN} - V_{OUT} = 1V$, $V_{OUT} = 3.23V$ | 300 | 360 | – | mA | |
| V_{RLOAD} | Load Regulation | $V_{IN} = 4.3V$ $1mA \leq I_{OUT} \leq 300mA$ | – | 13 | 15 | mV | |
| V_{RLINE} | Line Regulation | $4.3V \leq V_{IN} \leq 6V$ $I_{OUT} = 30mA$ | – | 1 | 15 | mV | |
| V_{DROP} | Dropout Voltage | $I_{OUT} = 10mA$ | – | 6.5 | 10 | mV | |
| | | $I_{OUT} = 100mA$ | – | 65 | 100 | | |
| | | $I_{OUT} = 300mA$ | – | 200 | 300 | | |
| I_Q | Quiescent Current | $V_{IN} = 4.3V$, $I_{OUT} = 0mA$ | – | 60 | 90 | μA | |
| I_{STD} | Standby Current | $V_{IN} = 4.3V$ V_{CE} in OFF mode | – | 0.01 | 1.0 | μA | |
| PSRR | Power Supply Rejection Ratio | Ripple 0.5Vp-p, $V_{IN} = 4.3V$ | $f = 100Hz$ | – | 65 | – | dB |
| | | | $f = 1KHz$ | – | 65 | – | dB |
| $(\Delta V_{OUT}/V_{OUT})/\Delta T$ | Output Voltage Temperature Coefficient | $I_{OUT} = 30mA$ | – | ± 100 | – | ppm/ $^\circ C$ | |
| I_{SHORT} | Short Current Limit | $V_{OUT} = 0V$ | – | 50 | – | mA | |
| V_{NOISE} | RMS Output Noise | $10Hz \leq f \leq 100kHz$ | – | 50 | – | μV_{rms} | |
| – | CE "High" Voltage | CE input voltage "High" | 1.5 | – | – | V | |
| – | CE "Low" Voltage | CE input voltage "Low" | – | – | 0.4 | V | |
| – | Thermal Shutdown | – | – | +160 | – | $^\circ C$ | |
| – | Thermal Shutdown Hysteresis | – | – | +25 | – | $^\circ C$ | |

Electrical Characteristics (Cont.)

AP2125-4.15 Electrical Characteristics (@ $V_{IN} = 5.15V$, $T_A = +25^\circ C$, $C_{IN} = 1\mu F$, $C_{OUT} = 1\mu F$, **Bold** typeface applies over $-40^\circ C \leq T_J \leq +85^\circ C$, unless otherwise specified.)

| Symbol | Parameter | Conditions | Min | Typ | Max | Unit | |
|-------------------------------------|--|---|-----------|-----------------------------|-------|-----------------|----|
| V_{OUT} | Output Voltage | $V_{IN} = 5.15V$ $1mA \leq I_{OUT} \leq 30mA$ | 4.067 | 4.15 | 4.233 | V | |
| V_{IN} | Input Voltage | – | – | – | 6 | V | |
| $I_{OUT(MAX)}$ | Maximum Output Current | $V_{IN} - V_{OUT} = 1V$, $V_{OUT} = 4.06V$ | 300 | 360 | – | mA | |
| V_{RLOAD} | Load Regulation | $V_{IN} = 5.15V$ $1mA \leq I_{OUT} \leq 300mA$ | – | 13 | 15 | mV | |
| V_{RLINE} | Line Regulation | $5.15V \leq V_{IN} \leq 6V$ $I_{OUT} = 30mA$ | – | 1 | 15 | mV | |
| V_{DROP} | Dropout Voltage | $I_{OUT} = 10mA$ | – | 6.5 | 10 | mV | |
| | | $I_{OUT} = 100mA$ | – | 65 | 100 | | |
| | | $I_{OUT} = 300mA$ | – | 200 | 300 | | |
| I_Q | Quiescent Current | $V_{IN} = 5.15V$, $I_{OUT} = 0mA$ | – | 60 | 90 | μA | |
| I_{STD} | Standby Current | $V_{IN} = 5.15V$ V_{CE} in OFF mode | – | 0.01 | 1.0 | μA | |
| PSRR | Power Supply Rejection Ratio | Ripple 0.5Vp-p, $V_{IN} = 5.15V$ | f = 100Hz | – | 65 | – | dB |
| | | | f = 1KHz | – | 65 | – | dB |
| $(\Delta V_{OUT}/V_{OUT})/\Delta T$ | Output Voltage Temperature Coefficient | $I_{OUT} = 30mA$ | – | ± 100 | – | ppm/ $^\circ C$ | |
| I_{SHORT} | Short Current Limit | $V_{OUT} = 0V$ | – | 50 | – | mA | |
| V_{NOISE} | RMS Output Noise | $10Hz \leq f \leq 100kHz$ | – | 50 | – | μV_{rms} | |
| – | CE "High" Voltage | CE input voltage "High" | 1.5 | – | – | V | |
| – | CE "Low" Voltage | CE input voltage "Low" | – | – | 0.4 | V | |
| – | Thermal Shutdown | – | – | +160 | – | $^\circ C$ | |
| – | Thermal Shutdown Hysteresis | – | – | +25 | – | $^\circ C$ | |

Electrical Characteristics (Cont.)

AP2125-4.2 Electrical Characteristics (@ $V_{IN} = 5.2V$, $T_A = +25^\circ C$, $C_{IN} = 1\mu F$, $C_{OUT} = 1\mu F$, **Bold** typeface applies over $-40^\circ C \leq T_J \leq +85^\circ C$, unless otherwise specified.)

| Symbol | Parameter | Conditions | Min | Typ | Max | Unit | |
|-------------------------------------|--|--|-------------|-----------------------------|-------|-----------------|----|
| V_{OUT} | Output Voltage | $V_{IN} = 5.2V$ $1mA \leq I_{OUT} \leq 30mA$ | 4.116 | 4.2 | 4.284 | V | |
| V_{IN} | Input Voltage | – | – | – | 6 | V | |
| $I_{OUT(MAX)}$ | Maximum Output Current | $V_{IN} - V_{OUT} = 1V$, $V_{OUT} = 4.12V$ | 300 | 360 | – | mA | |
| V_{RLOAD} | Load Regulation | $V_{IN} = 5.2V$ $1mA \leq I_{OUT} \leq 300mA$ | – | 13 | 15 | mV | |
| V_{RLINE} | Line Regulation | $5.2V \leq V_{IN} \leq 6V$ $I_{OUT} = 30mA$ | – | 1 | 15 | mV | |
| V_{DROP} | Dropout Voltage | $I_{OUT} = 10mA$ | – | 6.5 | 10 | mV | |
| | | $I_{OUT} = 100mA$ | – | 65 | 100 | | |
| | | $I_{OUT} = 300mA$ | – | 200 | 300 | | |
| I_Q | Quiescent Current | $V_{IN} = 5.2V$, $I_{OUT} = 0mA$ | – | 60 | 90 | μA | |
| I_{STD} | Standby Current | $V_{IN} = 5.2V$ V_{CE} in OFF mode | – | 0.01 | 1.0 | μA | |
| PSRR | Power Supply Rejection Ratio | Ripple 0.5Vp-p, $V_{IN} = 5.2V$ | $f = 100Hz$ | – | 65 | – | dB |
| | | | $f = 1KHz$ | – | 65 | – | dB |
| $(\Delta V_{OUT}/V_{OUT})/\Delta T$ | Output Voltage Temperature Coefficient | $I_{OUT} = 30mA$ | – | ± 100 | – | ppm/ $^\circ C$ | |
| I_{SHORT} | Short Current Limit | $V_{OUT} = 0V$ | – | 50 | – | mA | |
| V_{NOISE} | RMS Output Noise | $10Hz \leq f \leq 100kHz$ | – | 50 | – | μV_{rms} | |
| – | CE "High" Voltage | CE input voltage "High" | 1.5 | – | – | V | |
| – | CE "Low" Voltage | CE input voltage "Low" | – | – | 0.4 | V | |
| – | Thermal Shutdown | – | – | +160 | – | $^\circ C$ | |
| – | Thermal Shutdown Hysteresis | – | – | +25 | – | $^\circ C$ | |

Performance Characteristics

Output Voltage vs. Output Current

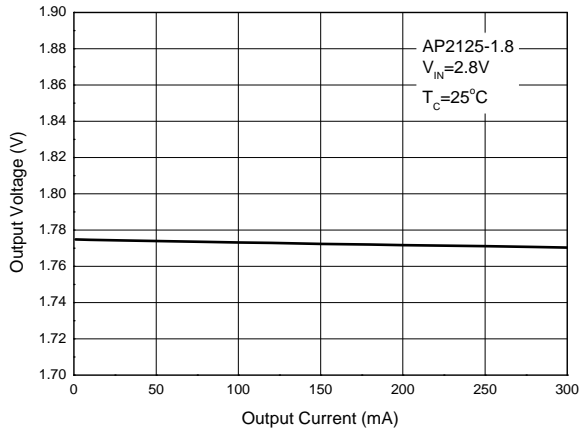

Output Voltage vs. Output Current

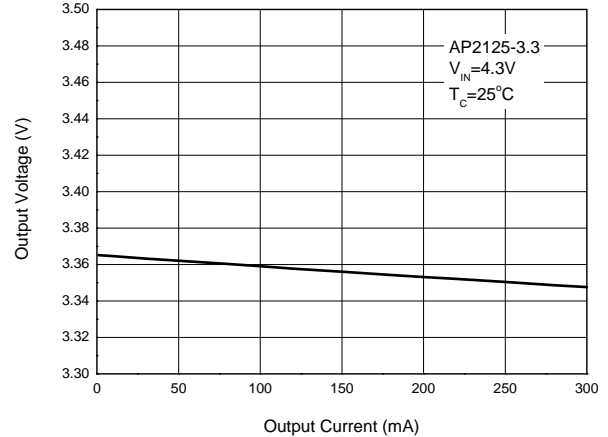

Dropout Voltage vs. Output Current

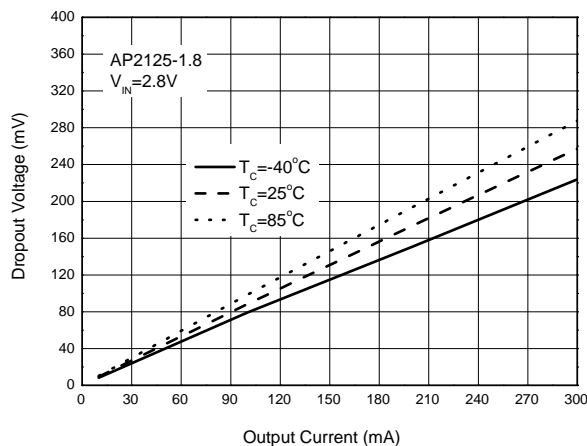

Dropout Voltage vs. Output Current

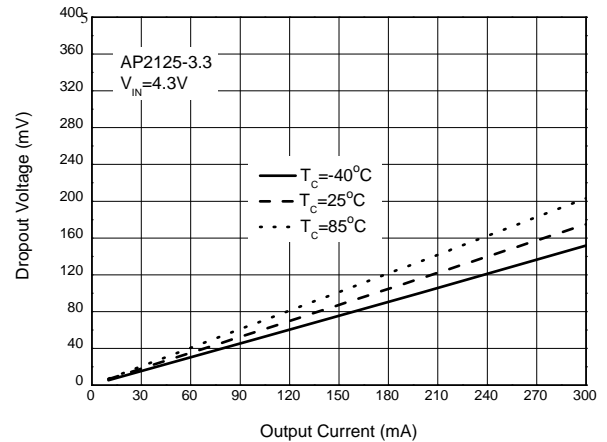

Dropout Voltage vs. Case Temperature

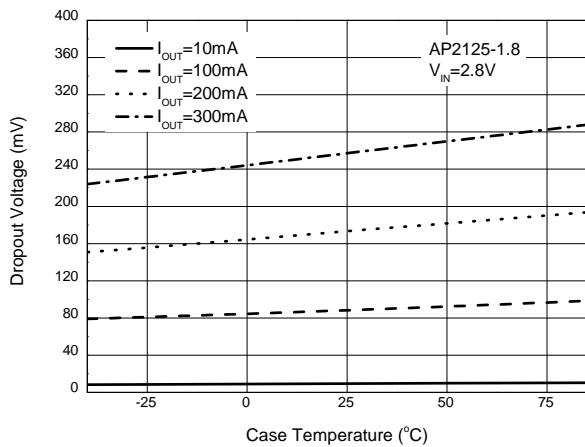

Dropout Voltage vs. Case Temperature

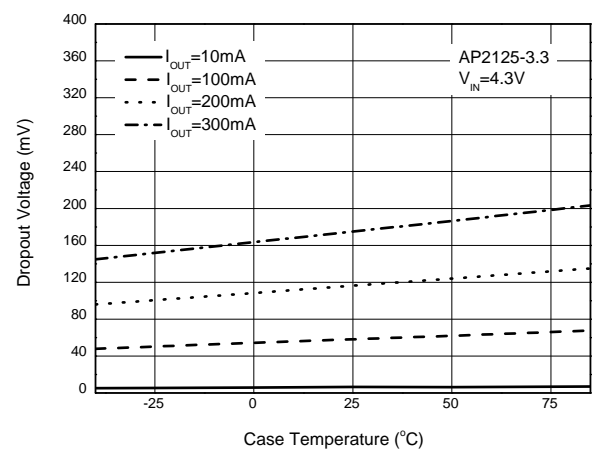

Performance Characteristics (Cont.)

Current Limit

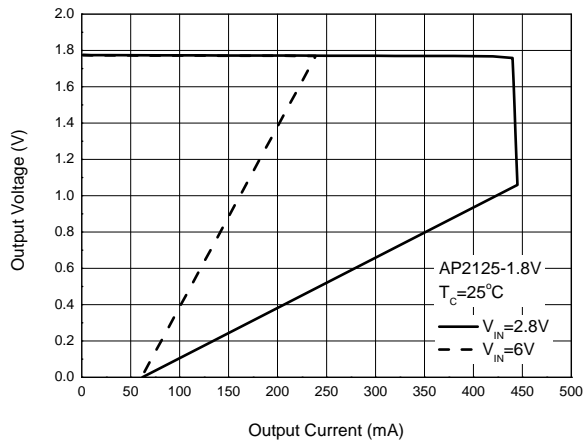

Current Limit

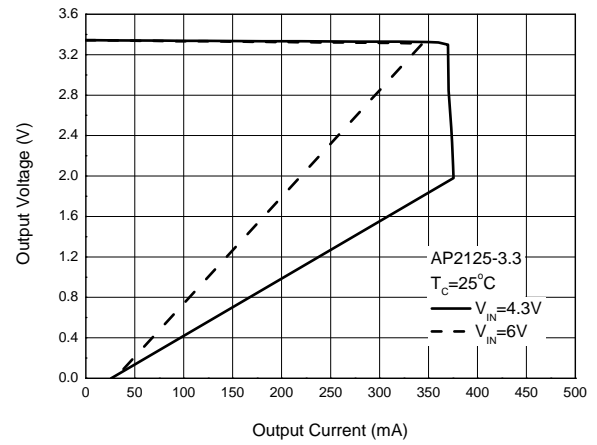

Current Limit

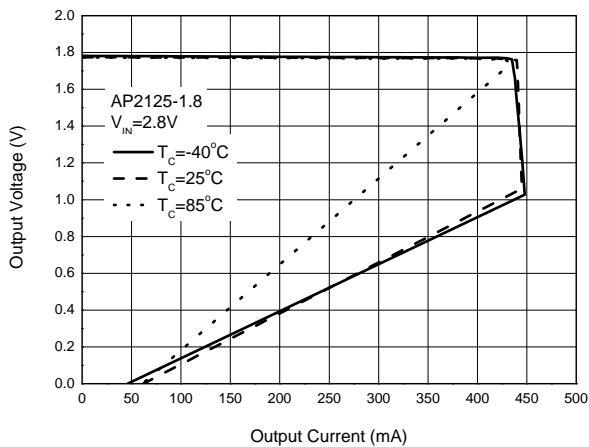

Current Limit

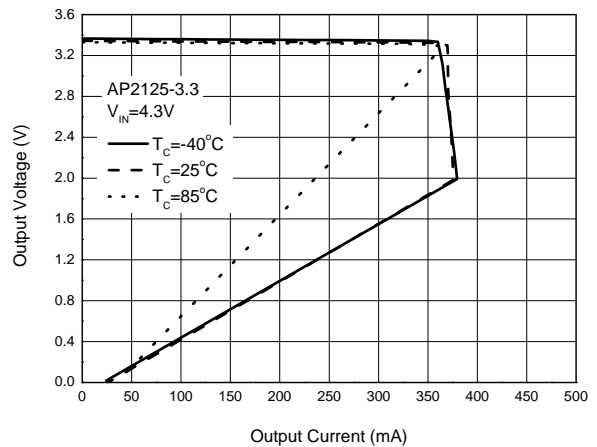

Output Voltage vs. Input Voltage

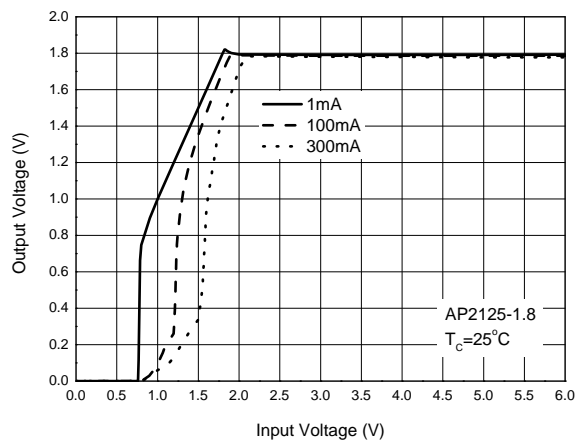

Output Voltage vs. Input Voltage

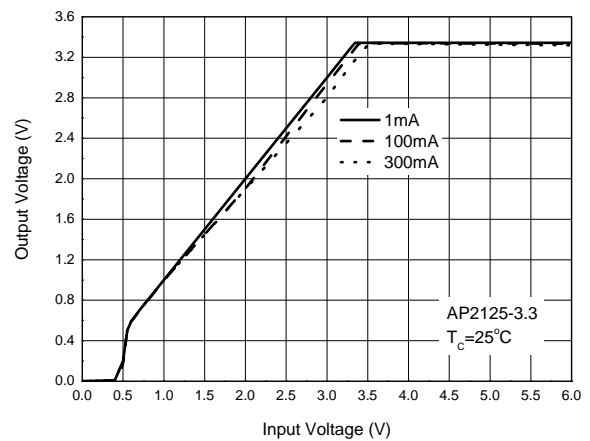

Performance Characteristics (Cont.)

Output Voltage vs. Input Voltage

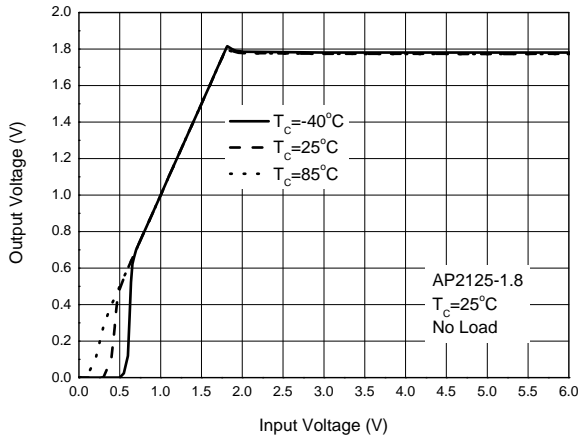

Output Voltage vs. Input Voltage

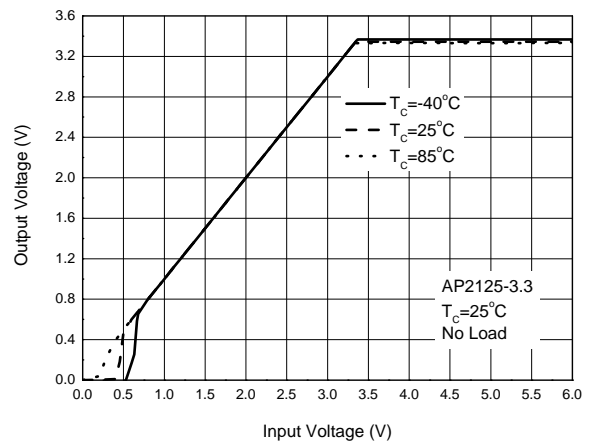

Output Voltage vs. Case Temperature

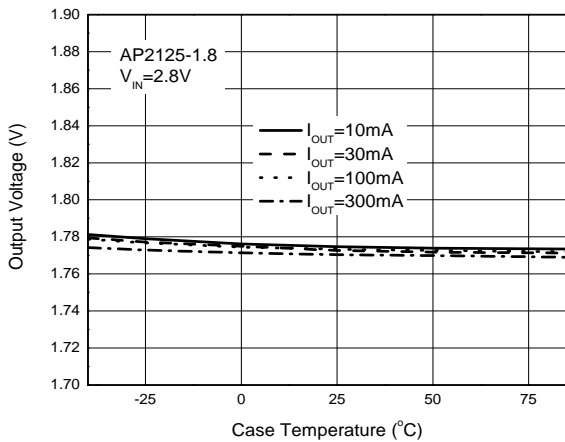

Output Voltage vs. Case Temperature

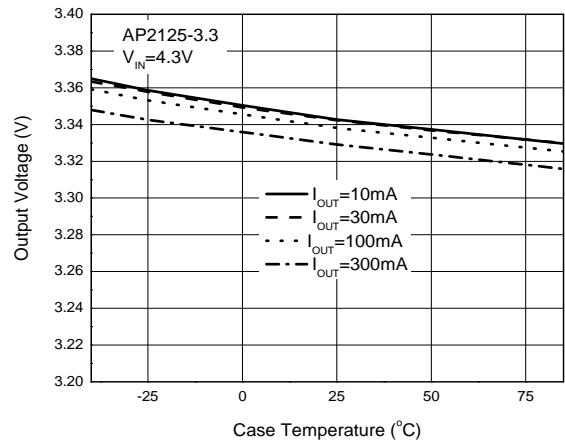

Supply Current vs. Input Voltage

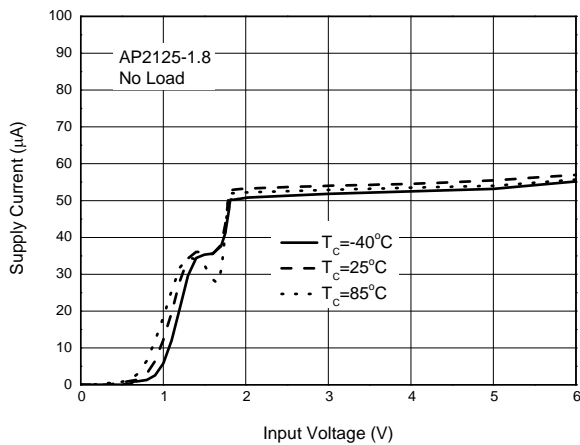

Supply Current vs. Input Voltage

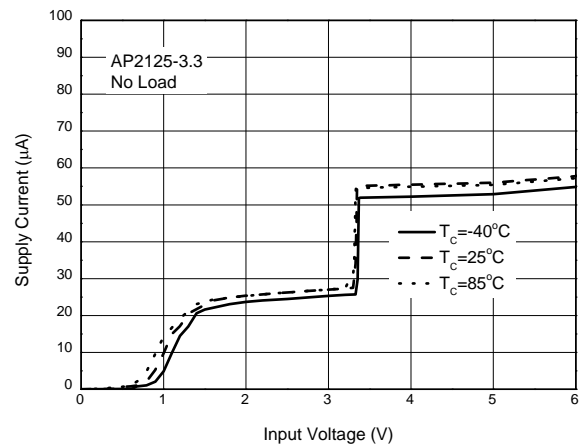

Performance Characteristics (Cont.)

Supply Current vs. Case Temperature

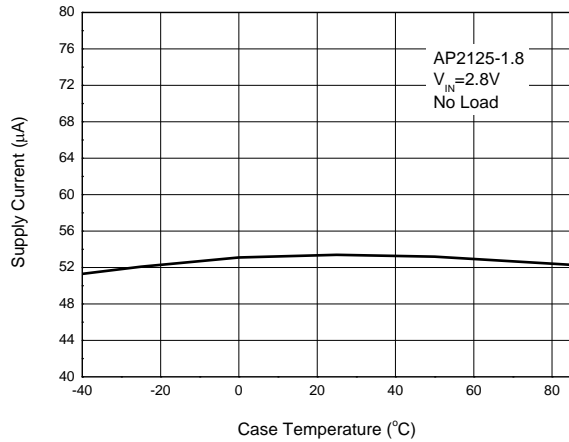

Supply Current vs. Case Temperature

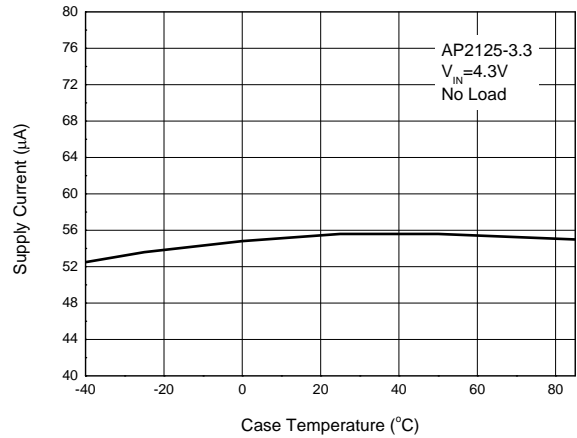

Supply Current vs. Output Current

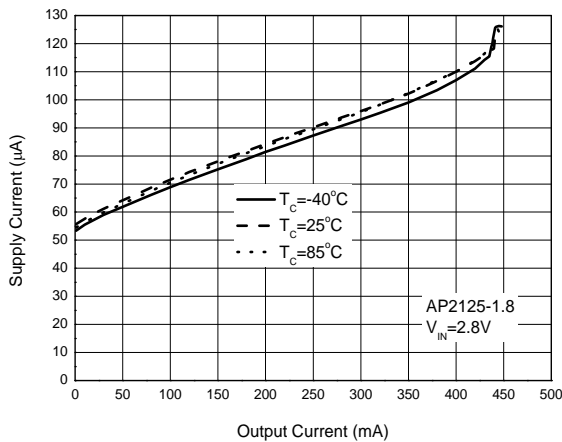

Supply Current vs. Output Current

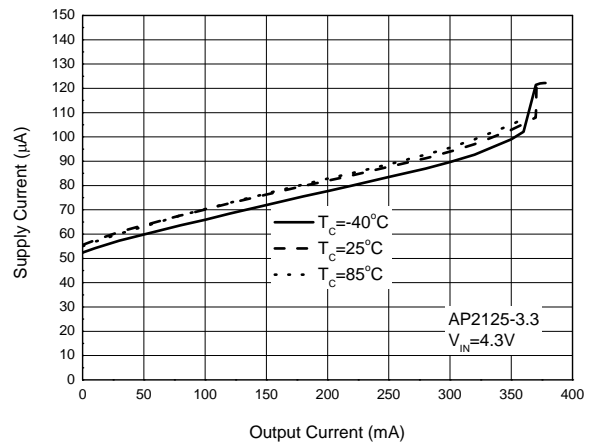

Supply Current vs. Output Current

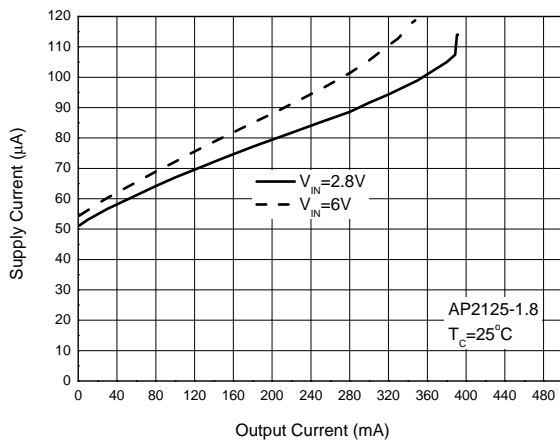

Supply Current vs. Output Current

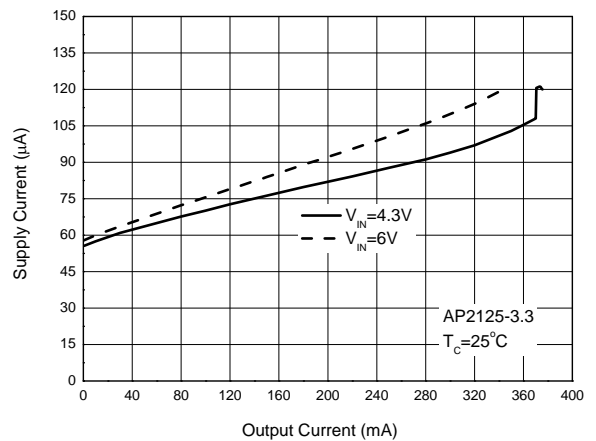

Performance Characteristics (Cont.)

Line Transient

(Conditions: $I_{OUT} = 30\text{mA}$, $C_{OUT} = 1\mu\text{F}$, $V_{IN} = 2.8\text{V to } 3.8\text{V}$)

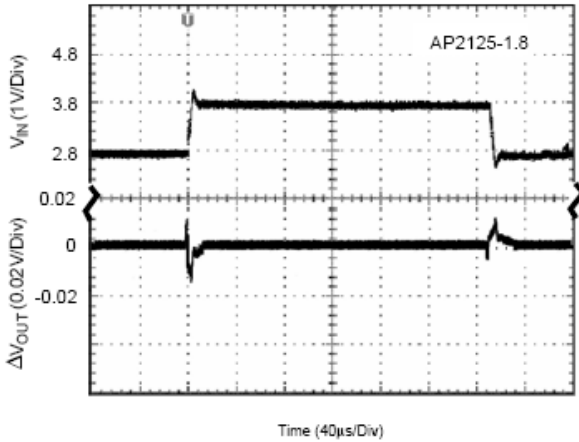

Load Transient

(Conditions: $I_{OUT} = 10 \text{ to } 100\text{mA}$, $C_{IN} = 1\mu\text{F}$, $C_{OUT} = 1\mu\text{F}$, $V_{IN} = 2.8\text{V}$)

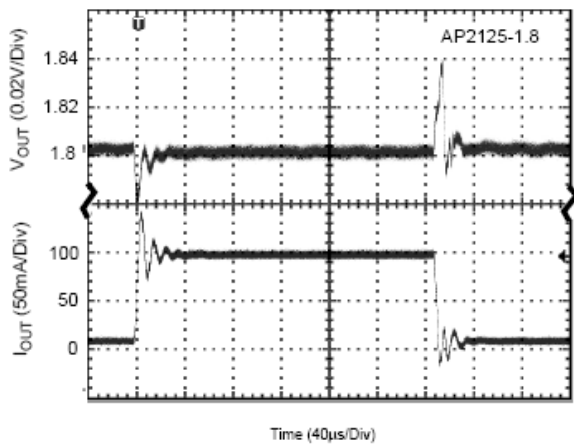

Enable Input Response and Auto-discharge

(Conditions: $V_{CE} = 0 \text{ to } 3\text{V}$, $C_{IN} = 1\mu\text{F}$, $C_{OUT} = 1\mu\text{F}$, $V_{IN} = 3\text{V}$, no Load)

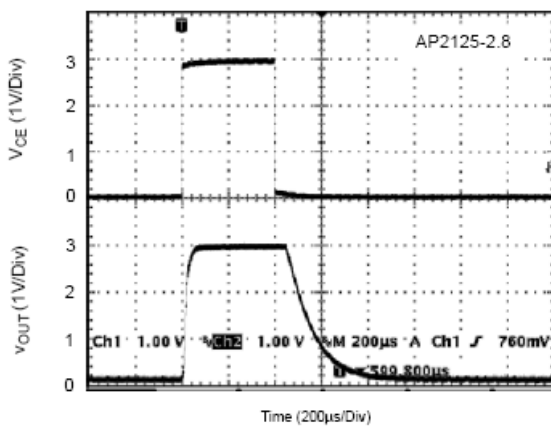

Line Transient

(Conditions: $I_{OUT} = 30\text{mA}$, $C_{OUT} = 1\mu\text{F}$, $V_{IN} = 4\text{V to } 5\text{V}$)

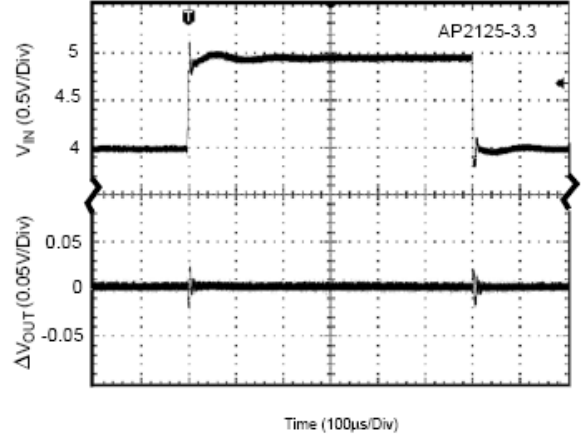

Load Transient

(Conditions: $I_{OUT} = 10 \text{ to } 100\text{mA}$, $C_{IN} = 1\mu\text{F}$, $C_{OUT} = 1\mu\text{F}$, $V_{IN} = 4.3\text{V}$)

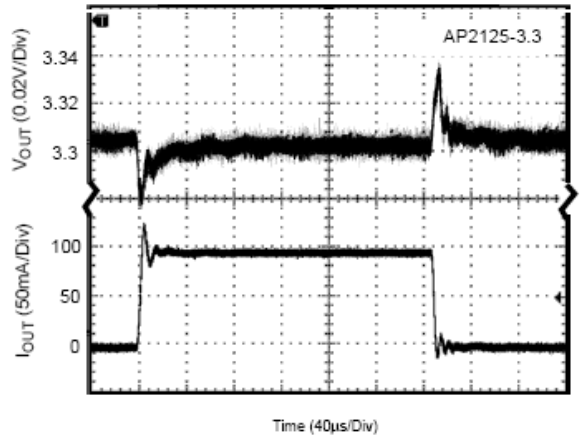

ESR vs. Output Current

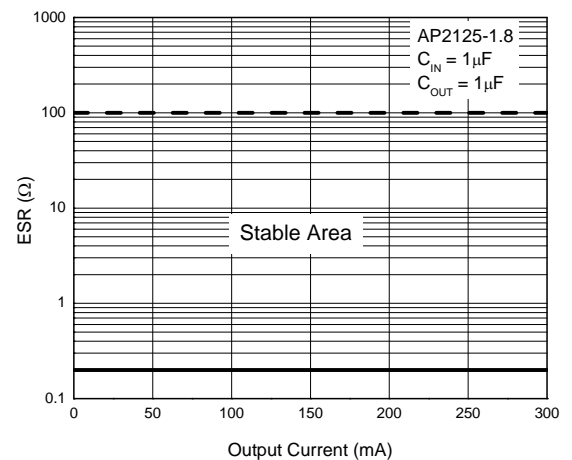

Performance Characteristics (Cont.)

PSRR

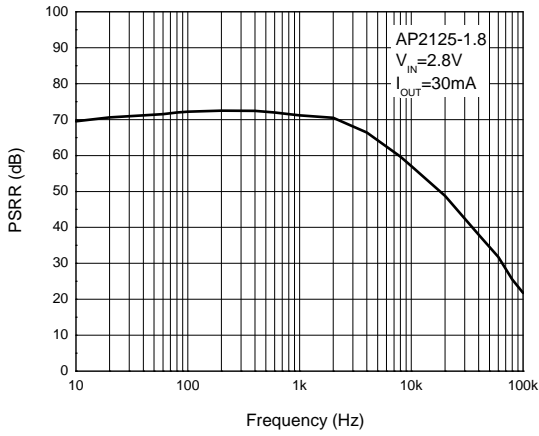

PSRR

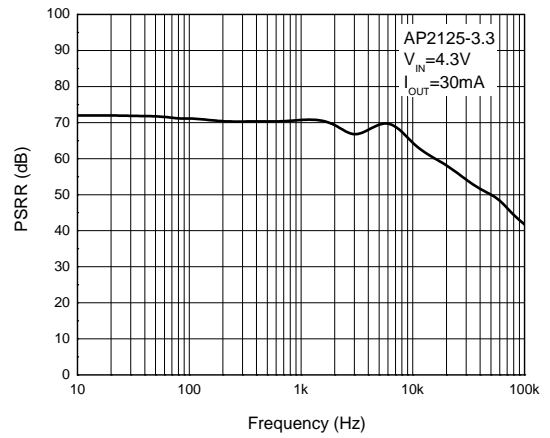

Power Dissipation vs. Ambient Temperature

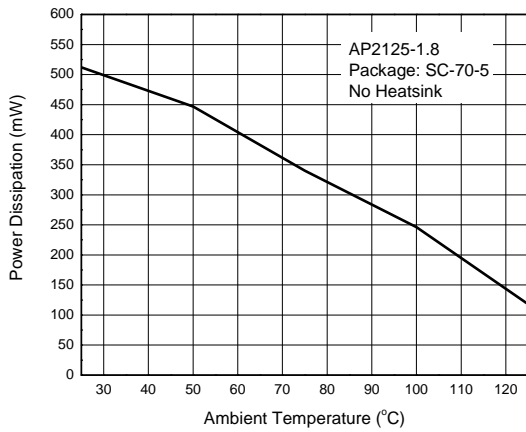

Power Dissipation vs. Ambient Temperature

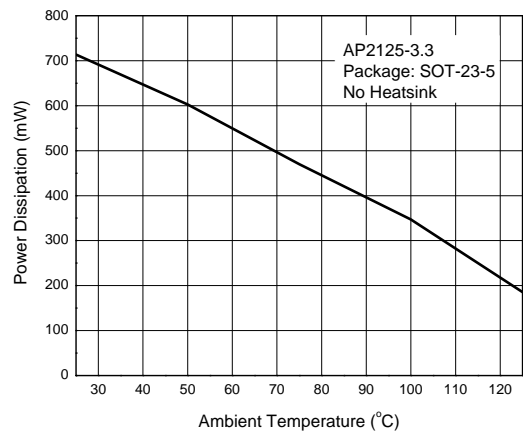

Ordering Information

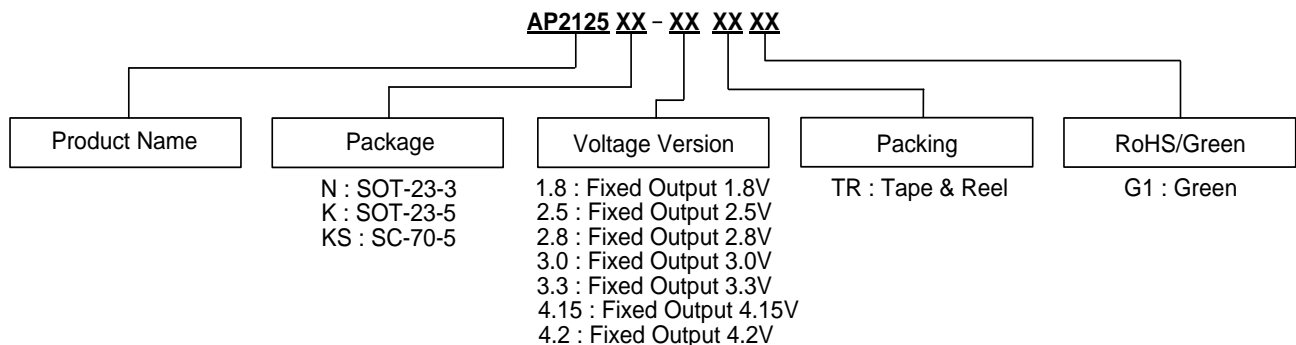

| Package | Temperature Range | Part Number | Marking ID | Packing |
|----------|-------------------|------------------|------------|------------------|
| SOT-23-3 | -40 to +85°C | AP2125N-1.8TRG1 | GJ2 | 3000/Tape & Reel |
| | | AP2125N-2.5TRG1 | GJ4 | 3000/Tape & Reel |
| | | AP2125N-2.8TRG1 | GJ5 | 3000/Tape & Reel |
| | | AP2125N-3.0TRG1 | GJ6 | 3000/Tape & Reel |
| | | AP2125N-3.3TRG1 | GJ7 | 3000/Tape & Reel |
| | | AP2125N-4.2TRG1 | GJ3 | 3000/Tape & Reel |
| SOT-23-5 | -40 to +85°C | AP2125K-1.8TRG1 | GCB | 3000/Tape & Reel |
| | | AP2125K-2.5TRG1 | GCD | 3000/Tape & Reel |
| | | AP2125K-2.8TRG1 | GCE | 3000/Tape & Reel |
| | | AP2125K-3.0TRG1 | GCF | 3000/Tape & Reel |
| | | AP2125K-3.3TRG1 | GCG | 3000/Tape & Reel |
| | | AP2125K-4.15TRG1 | GCJ | 3000/Tape & Reel |
| SC-70-5 | -40 to +85°C | AP2125KS-1.8TRG1 | B6 | 3000/Tape & Reel |
| | | AP2125KS-2.5TRG1 | C5 | 3000/Tape & Reel |
| | | AP2125KS-2.8TRG1 | B7 | 3000/Tape & Reel |
| | | AP2125KS-3.0TRG1 | C6 | 3000/Tape & Reel |
| | | AP2125KS-3.3TRG1 | B8 | 3000/Tape & Reel |
| | | AP2125KS-4.2TRG1 | C4 | 3000/Tape & Reel |

Marking Information

(1) SOT-23-3

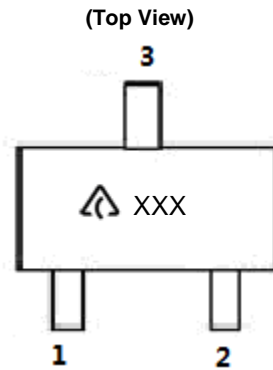

 : Logo
 XXX: Marking ID
 (See Ordering Information)

(2) SOT-23-5

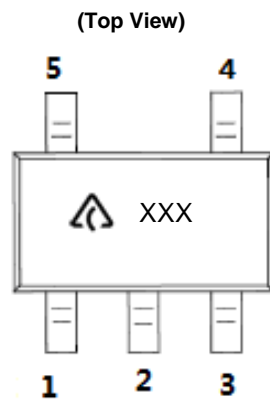

 : Logo
 XXX: Marking ID
 (See Ordering Information)

(3) SC-70-5

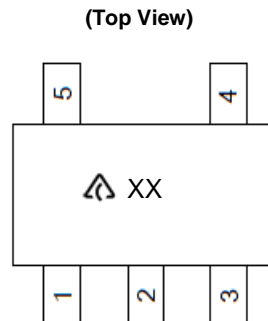

 : Logo
 XX: Marking ID
 (See Ordering Information)

Package Outline Dimensions (All dimensions in mm(inch).)

(1) Package Type: SOT-23-3

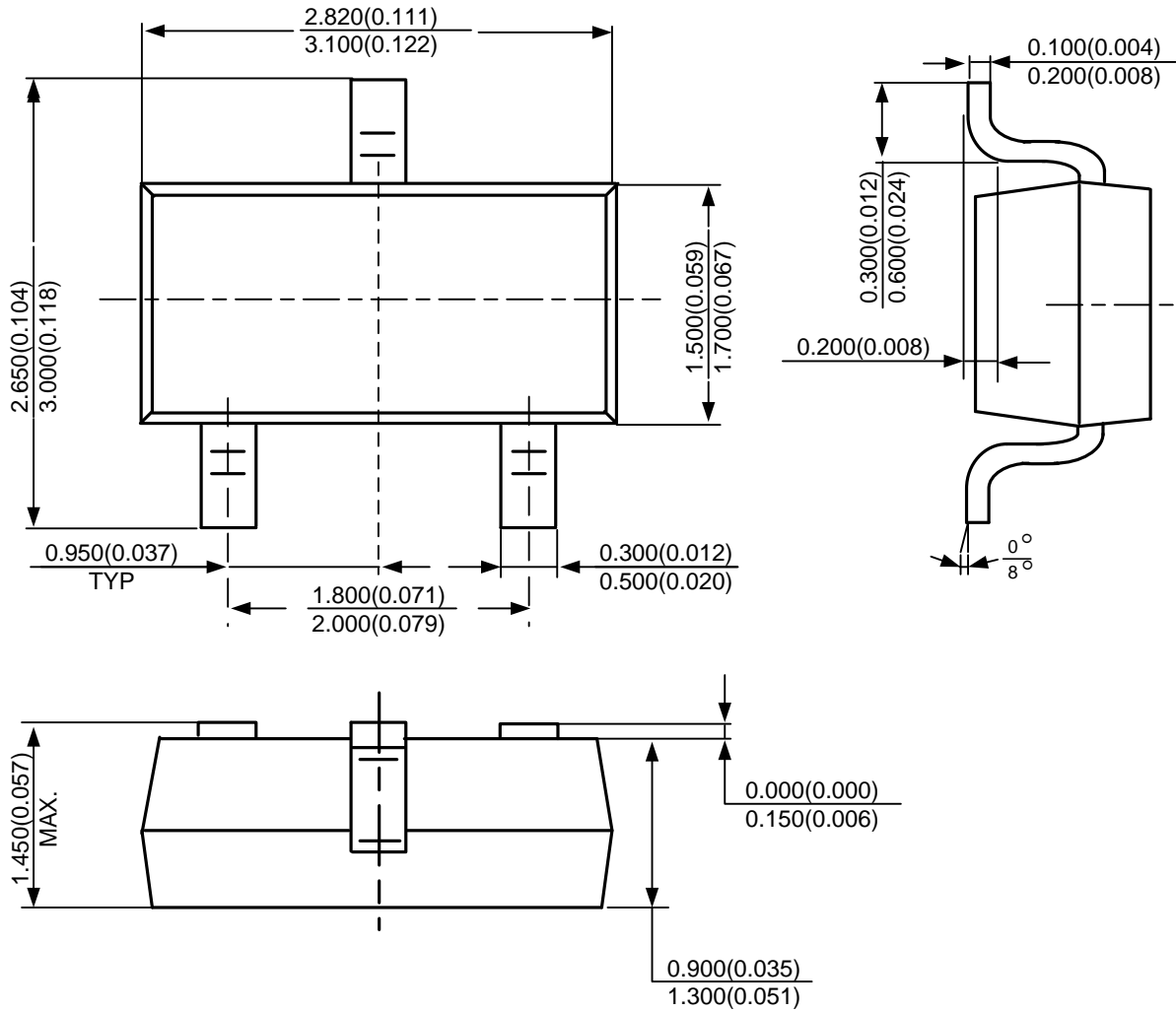

Package Outline Dimensions (Cont. All dimensions in mm(inch).)

(2) Package Type: SOT-23-5

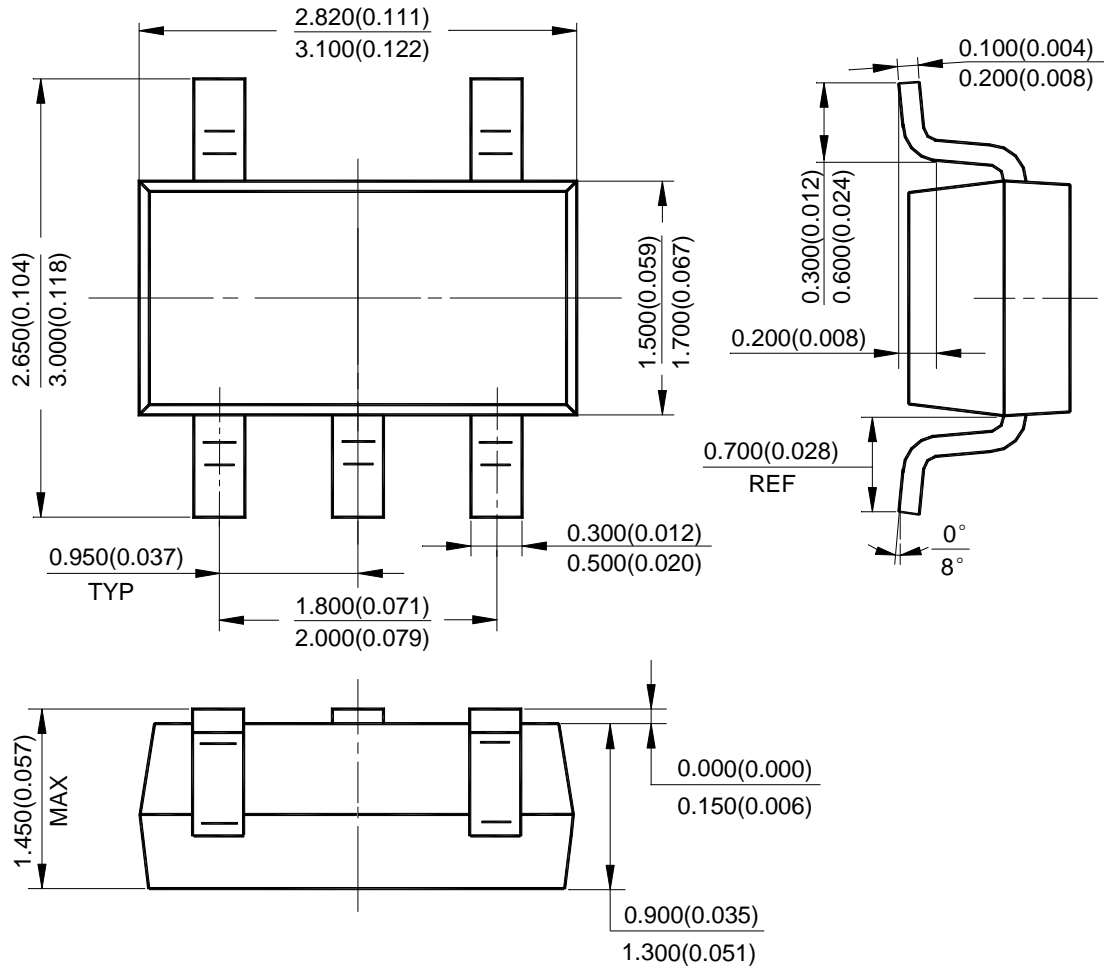

Package Outline Dimensions (Cont. All dimensions in mm(inch).)

(3) Package Type: SC-70-5

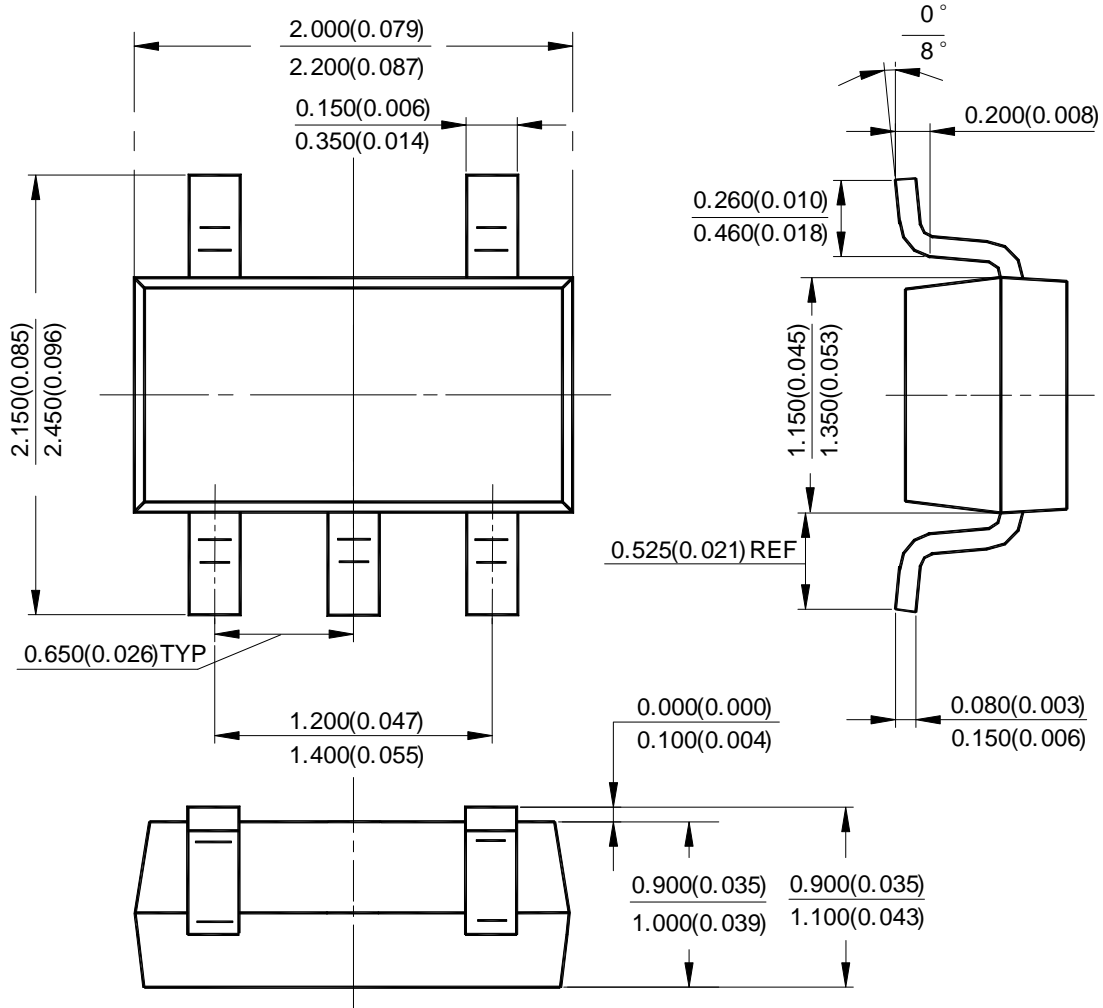

Suggested Pad Layout

(1) Package Type: SOT-23-3

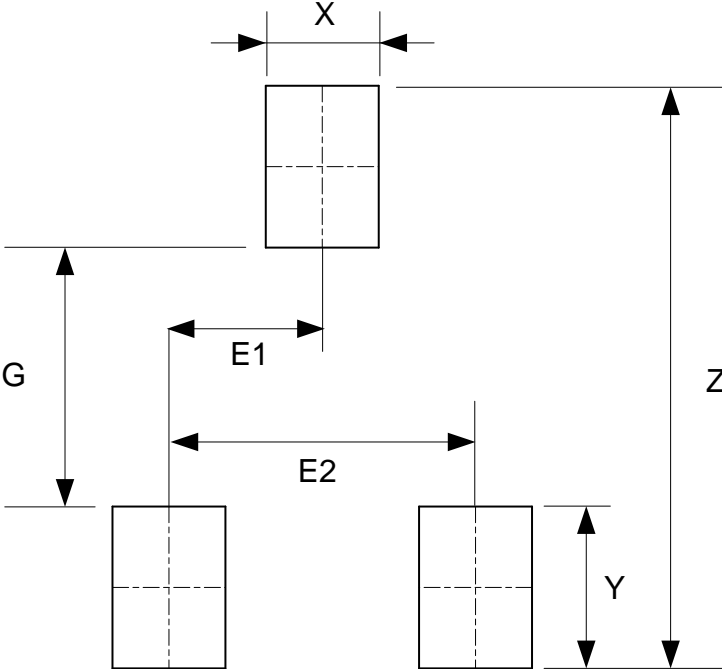

| Dimensions | Z (mm)/(inch) | G (mm)/(inch) | X (mm)/(inch) | Y (mm)/(inch) | E1 (mm)/(inch) | E2 (mm)/(inch) |
|------------|------------------|------------------|------------------|------------------|-------------------|-------------------|
| Value | 3.600/0.142 | 1.600/0.063 | 0.700/0.028 | 1.000/0.039 | 0.950/0.037 | 1.900/0.075 |

Suggested Pad Layout (Cont.)

(2) Package Type: SOT-23-5

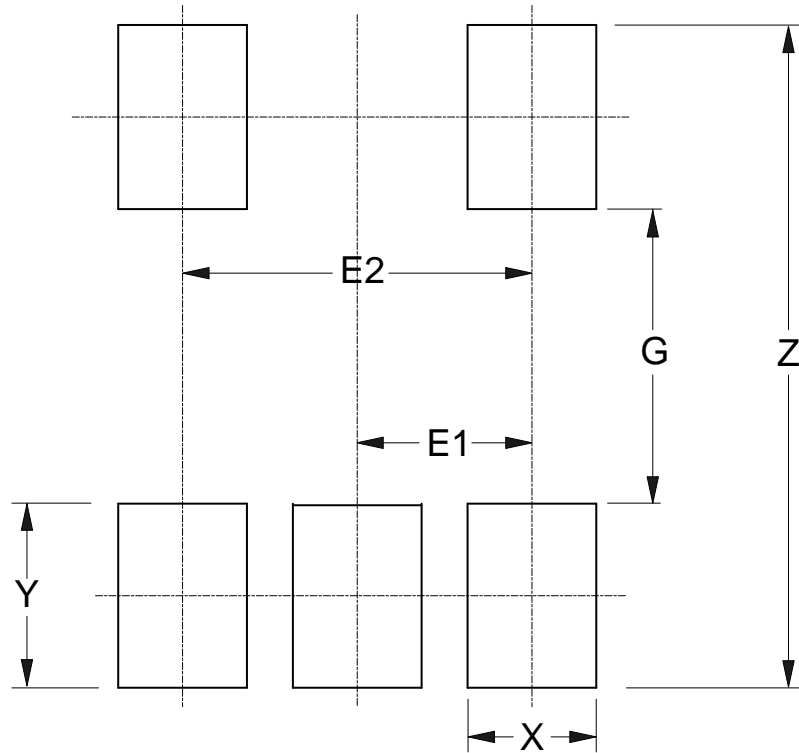

| Dimensions | Z (mm)/(inch) | G (mm)/(inch) | X (mm)/(inch) | Y (mm)/(inch) | E1 (mm)/(inch) | E2 (mm)/(inch) |
|------------|------------------|------------------|------------------|------------------|-------------------|-------------------|
| Value | 3.600/0.142 | 1.600/0.063 | 0.700/0.028 | 1.000/0.039 | 0.950/0.037 | 1.900/0.075 |

Suggested Pad Layout (Cont.)

(3) Package Type: SC-70-5

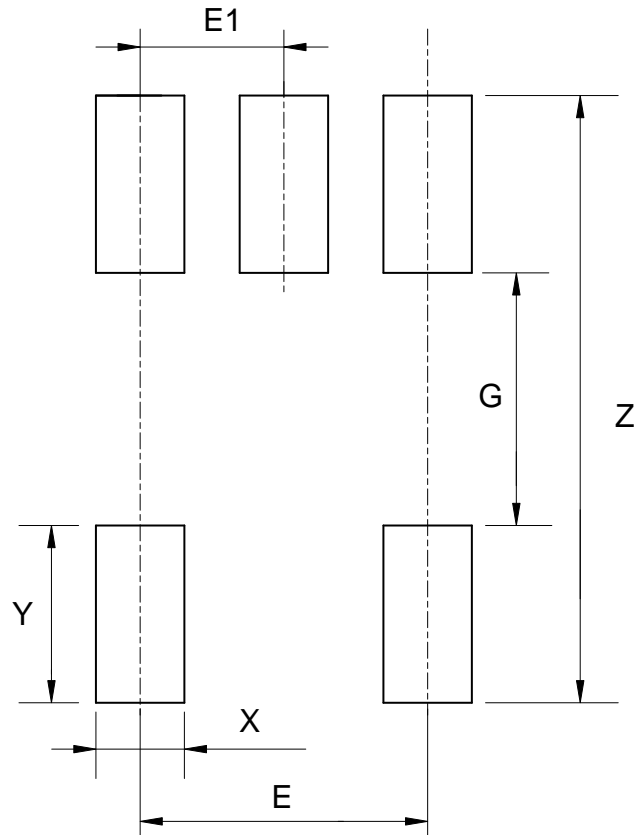

| Dimensions | Z (mm)/(inch) | G (mm)/(inch) | X (mm)/(inch) | Y (mm)/(inch) | E (mm)/(inch) | E1 (mm)/(inch) |
|------------|------------------|------------------|------------------|------------------|------------------|-------------------|
| Value | 2.740/0.108 | 1.140/0.045 | 0.400/0.016 | 0.800/0.031 | 1.300/0.051 | 0.650/0.026 |

IMPORTANT NOTICE

DIODES INCORPORATED MAKES NO WARRANTY OF ANY KIND, EXPRESS OR IMPLIED, WITH REGARDS TO THIS DOCUMENT, INCLUDING, BUT NOT LIMITED TO, THE IMPLIED WARRANTIES OF MERCHANTABILITY AND FITNESS FOR A PARTICULAR PURPOSE (AND THEIR EQUIVALENTS UNDER THE LAWS OF ANY JURISDICTION).

Diodes Incorporated and its subsidiaries reserve the right to make modifications, enhancements, improvements, corrections or other changes without further notice to this document and any product described herein. Diodes Incorporated does not assume any liability arising out of the application or use of this document or any product described herein; neither does Diodes Incorporated convey any license under its patent or trademark rights, nor the rights of others. Any Customer or user of this document or products described herein in such applications shall assume all risks of such use and will agree to hold Diodes Incorporated and all the companies whose products are represented on Diodes Incorporated website, harmless against all damages.

Diodes Incorporated does not warrant or accept any liability whatsoever in respect of any products purchased through unauthorized sales channel. Should Customers purchase or use Diodes Incorporated products for any unintended or unauthorized application, Customers shall indemnify and hold Diodes Incorporated and its representatives harmless against all claims, damages, expenses, and attorney fees arising out of, directly or indirectly, any claim of personal injury or death associated with such unintended or unauthorized application.

Products described herein may be covered by one or more United States, international or foreign patents pending. Product names and markings noted herein may also be covered by one or more United States, international or foreign trademarks.

This document is written in English but may be translated into multiple languages for reference. Only the English version of this document is the final and determinative format released by Diodes Incorporated.

LIFE SUPPORT

Diodes Incorporated products are specifically not authorized for use as critical components in life support devices or systems without the express written approval of the Chief Executive Officer of Diodes Incorporated. As used herein:

A. Life support devices or systems are devices or systems which:

1. are intended to implant into the body, or
2. support or sustain life and whose failure to perform when properly used in accordance with instructions for use provided in the labeling can be reasonably expected to result in significant injury to the user.

B. A critical component is any component in a life support device or system whose failure to perform can be reasonably expected to cause the failure of the life support device or to affect its safety or effectiveness.

Customers represent that they have all necessary expertise in the safety and regulatory ramifications of their life support devices or systems, and acknowledge and agree that they are solely responsible for all legal, regulatory and safety-related requirements concerning their products and any use of Diodes Incorporated products in such safety-critical, life support devices or systems, notwithstanding any devices- or systems-related information or support that may be provided by Diodes Incorporated. Further, Customers must fully indemnify Diodes Incorporated and its representatives against any damages arising out of the use of Diodes Incorporated products in such safety-critical, life support devices or systems.

Copyright © 2016, Diodes Incorporated

www.diodes.com

X-ON Electronics

Largest Supplier of Electrical and Electronic Components

Click to view similar products for [LDO Voltage Regulators](#) category:

Click to view products by [Diodes Incorporated](#) manufacturer:

Other Similar products are found below :

[M38D29FFHP#U1](#) [702103A](#) [717726C](#) [742457H](#) [MP20051DN-LF-Z](#) [R5F111PGGFB#30](#) [AP7363-SP-13](#) [NCP103AMX285TCG](#)
[NCV8664CST33T3G](#) [NCV8752AMX28TCG](#) [L9454](#) [AP7362-HA-7](#) [LX13043CLD](#) [TCR3DF185,LM\(CT](#) [TCR3DF24,LM\(CT](#)
[TCR3DF285,LM\(CT](#) [TCR3DF31,LM\(CT](#) [TCR3DF45,LM\(CT](#) [TLF4949EJ](#) [MP2013GQ-33-Z](#) [L9708](#) [L970813TR](#) [030014BB](#) [059985X](#)
[NCP121AMX173TCG](#) [NCP4687DH15T1G](#) [NCV8703MX30TCG](#) [701326R](#) [702087BB](#) [755078E](#) [TCR2EN28,LF\(S](#) [LM1117DT-1.8/NO](#)
[LT1086CM#TRPBF](#) [AZ1085S2-1.5TRE1](#) [MAX15101EWL+T](#) [NCV8170AXV250T2G](#) [SCD337BTG](#) [TCR3DF27,LM\(CT](#)
[TCR3DF19,LM\(CT](#) [TCR3DF125,LM\(CT](#) [TCR2EN18,LF\(S](#) [MAX15103EWL+T](#) [TS2937CZ-5.0 C0](#) [MAX8878EUK30-T](#) [MAX663CPA](#)
[NCV4269CPD50R2G](#) [NCV8716MT30TBG](#) [AZ1117IH-1.2TRG1](#) [MP2013GQ-P](#) [AP2112R5A-3.3TRG1](#)