

MLX90380 - Triaxis[®] Resolver

Datasheet

1. Features and Benefits

- Triaxis[®] Hall Technology
- Sine and Cosine Analog Outputs
- Output Refresh Rate 4 μ s
- 3.3V and 5V Operating Supply Voltage
- Operating Temperature Range from -40°C to 150°C
- Selectable Magnetic Field Axis (X/Y - X/Z - Z/Y)
- Selectable Sensitivity Range (10mT ... 70mT)
- End-of-Shaft / Through-Shaft Operation
- Ratiometric Outputs
- Programming Through the Connector
- RoHS Compliant Packages:
 - Single Die – SOIC-8
 - Dual Die Fully Redundant – TSSOP-16

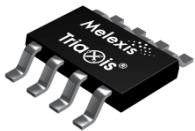

SOIC-8

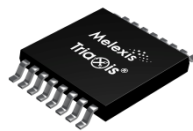

TSSOP-16

2. Application Examples

- Absolute Rotary Position Sensor
- Brushless Motor Control
 - Permanent Magnet Synchronous Motor
 - Brushless DC Motor (BLDC)
- Field-oriented Motor Control

3. Description

The MLX90380 is a monolithic contactless sensor IC sensitive to the flux density applied orthogonally and parallel to the IC surface.

High-speed dual analog outputs allow the MLX90380 to deliver accurate sine/cosine signals when used with a rotating permanent magnet.

With a wide range of operating temperature, supply voltage and magnetic flux density, the MLX90380 can resolve the angular position of a rotating axis over 360 degrees in many industrial and automotive applications.

Selectable magnetic axes ensure compatibility with end-of-shaft and through-shaft configurations.

Sensitivity and filter bandwidth can be programmed through the 4 application pins to optimally use the ADC input range of the companion MCU.



Figure 1: End of Shaft

Figure 2: Through Shaft

Contents

1. Features and Benefits	1
2. Application Examples	1
3. Description	1
4. Ordering Information	4
5. Functional Diagram	6
6. Glossary of Terms	6
7. Detailed General Description	7
8. Intrinsic Magnetic Axis	8
8.1. X/Y magnetic axis	9
8.2. X/Z magnetic axis	9
8.3. Z/Y magnetic axis	10
9. Pin Definitions and Descriptions	10
9.1. Pin Definition for SOIC-8.....	10
9.2. Pin Definition for TSSOP-16.....	11
10. Absolute Maximum Ratings	12
11. General Electrical Specifications	12
12. Magnetic Specifications	14
12.1. Sensitivity Temperature Coefficient Characteristic	16
12.2. Output Offset Temperature Drift Characteristic.....	16
12.2.1. Output Offset Temperature Drift Characteristic.....	17
12.2.2. Output Offset Temperature Drift Characteristic vs. Sensitivity	18
13. Recommended Application Diagrams	19
13.1. MLX90380 in SOIC-8 Package	19
13.1.1. Application Diagram VDD3V3	19
13.1.2. Application Diagram VDD5V	19
13.2. MLX90380 in TSSOP-16 Package.....	20
13.2.1. Application Diagram VDD3V3	20
13.2.2. Application Diagram VDD5V	21
14. Package Information	22
14.1. SOIC-8 Package Dimensions	22
14.2. SOIC-8 Pin out and Marking	22
14.3. SOIC-8 IMC Positioning.....	23

14.4. TSSOP-16 Package Dimensions	24
14.5. TSSOP-16 Pin out and Marking	25
14.6. TSSOP-16 IMC positioning	25
15. Standard Information	27
16. ESD Precautions.....	27
17. Contact.....	28
18. Disclaimer.....	28

4. Ordering Information ⁽¹⁾

Product Code	Temperature Code	Package Code	Option Code	Packing Form Code
MLX90380	L (-40°C to 150°C)	DC	BAB-003	RE
MLX90380	L (-40°C to 150°C)	DC	BAB-005	RE
MLX90380	L (-40°C to 150°C)	DC	BAB-023	RE
MLX90380	L (-40°C to 150°C)	DC	BAB-025	RE
MLX90380	L (-40°C to 150°C)	DC	BAB-043	RE
MLX90380	L (-40°C to 150°C)	DC	BAB-045	RE
MLX90380	L (-40°C to 150°C)	DC	BAB-103	RE
MLX90380	L (-40°C to 150°C)	DC	BAB-105	RE
MLX90380	L (-40°C to 150°C)	DC	BAB-123	RE
MLX90380	L (-40°C to 150°C)	DC	BAB-125	RE
MLX90380	L (-40°C to 150°C)	DC	BAB-143	RE
MLX90380	L (-40°C to 150°C)	DC	BAB-145	RE
MLX90380	L (-40°C to 150°C)	DC	BAB-506	RE
MLX90380	L (-40°C to 150°C)	GO	BAB-003	RE
MLX90380	L (-40°C to 150°C)	GO	BAB-005	RE
MLX90380	L (-40°C to 150°C)	GO	BAB-023	RE
MLX90380	L (-40°C to 150°C)	GO	BAB-025	RE
MLX90380	L (-40°C to 150°C)	GO	BAB-043	RE
MLX90380	L (-40°C to 150°C)	GO	BAB-045	RE
MLX90380	L (-40°C to 150°C)	GO	BAB-103	RE
MLX90380	L (-40°C to 150°C)	GO	BAB-105	RE
MLX90380	L (-40°C to 150°C)	GO	BAB-123	RE
MLX90380	L (-40°C to 150°C)	GO	BAB-125	RE
MLX90380	L (-40°C to 150°C)	GO	BAB-143	RE
MLX90380	L (-40°C to 150°C)	GO	BAB-145	RE

Table 1: Ordering Codes available. All option codes of Table 2 can be made.

¹ Other option codes and packing forms are available upon request. Every combination in Table 2 can be made pending on yearly volume. Please contact your sales representative to see what combinations are available.

Legend:

Temperature Code:	L: from -40°C to 150°C
Package Code:	DC: for SOIC-8 package GO: for TSSOP-16 package (dual die)
Option Code:	<p>BAX-123</p> <p>Sensitivity Temperature Coefficient:</p> <p>BAA-xxx: SmCo magnet BAB-xxx: NdFeB magnet BAC-xxx: Ferrite magnet</p> <p>Sensitivity:</p> <p>BAX-xx0: 40mT magnetic range⁽²⁾ BAX-xx1: 10mT magnetic range⁽²⁾ for 3.3V operating supply voltage only BAX-xx2: 20mT magnetic range⁽²⁾ BAX-xx3: 30mT magnetic range⁽²⁾ BAX-xx4: 50mT magnetic range⁽²⁾ BAX-xx5: 60mT magnetic range⁽²⁾ BAX-xx6: 70mT magnetic range⁽²⁾ BAX-xx7: 15mT magnetic range⁽²⁾ for 5V operating supply voltage only</p> <p>Magnetic axis:</p> <p>BAX-x0x: X/Y magnetic axis – equal sensitivity⁽³⁾ BAX-x1x: X/Z magnetic axis – equal sensitivity⁽³⁾ BAX-x2x: Z/Y magnetic axis – equal sensitivity⁽³⁾ BAX-x3x: X/Z magnetic axis – sensitivity mismatch⁽⁴⁾ BAX-x4x: Z/Y magnetic axis – sensitivity mismatch⁽⁴⁾</p> <p>Operating voltage and Bandwidth:</p> <p>BAX-0xx: 3.3V operating supply voltage – low BW BAX-1xx: 5V operating supply voltage – low BW BAX-2xx: 3.3V operating supply voltage – medium BW BAX-3xx: 5V operating supply voltage – medium BW BAX-4xx: 3.3V operating supply voltage – high BW BAX-5xx: 5V operating supply voltage – high BW</p>
Packing Form:	RE: for Reel
Ordering Example:	MLX90380LDC-BAA-000-RE: SOIC-8 150, SmCo magnet, 3.3V operating supply voltage, Low bandwidth, X/Y magnetic axis, 40mT full scale magnetic range, Reel

Table 2: Order code Description

² The magnetic range is the in-plane (X or Y) flux density, that results in a $\pm 40\%$ VDD output swing with a V_{OQ} of 50%VDD with $T_A=25^\circ\text{C}$, $V_{DD}=V_{DDNOM}$

³ Magnetic axis for: two pole magnet end of shaft / on axis and multi-pole magnet off-axis / through-shaft application.

⁴ Magnetic axis for: two pole magnet off-axis / through-shaft application. The magnetic flux norm for the Z axis is double the magnetic flux norm for the X or Y axis: $B_{xy}/B_z = 50\%$.

7. Detailed General Description

The MLX90380 is a monolithic sensor IC sensitive to the flux density applied orthogonally and parallel to the IC surface. High-speed dual analog outputs allow the MLX90380 to deliver accurate, contact-less, true 360Deg. sine/cosine signals when used with a rotating permanent magnet.

OUT₁ and OUT₂ output voltages are proportional to the applied magnetic field along 2 axes. Those 2 axes are specified by the option code. For example, option code BAA-000 is a chip where B_x and B_y components of the magnetic field are such that OUT₁=Voq₁+S₁×B_x and OUT₂=Voq₂+S₂×B_y.



Figure 4: Output characteristics

Customers can order pre-programmed devices. End of line calibration is optional to achieve higher position accuracy.

8. Intrinsic Magnetic Axis



Figure 5: Axis configuration

Figure 5 gives the axis convention. Thus, take for example an IC in Z/Y configuration. Then, OUT1 will give Bz & OUT2 will give By.

The following sections list a detailed explanation of the intrinsic axis. It explains clock wise and counter clock wise behavior of the angle calculation.

CW – Clockwise turn: The magnet needs to turn in the CW direction to get a positive slope of the angle calculated by ATAN.

CCW – Counterclockwise turn: The magnet needs to turn in the CCW direction to get a positive slope of the angle calculated by ATAN.

The CW - CCW rotation direction can be modified by changing the COS / SIN assignment to SIN / COS with an angle correction of 90 Deg.

$$\alpha = ATAN\left(\frac{SIN}{COS}\right)$$

The convention of preprogrammed parts is such that OUT2 is seen as SIN and OUT1 as COS.

8.1. X/Y magnetic axis



Figure 6: X/Y Magnetic Axis

8.2. X/Z magnetic axis



Figure 7: X/Z Magnetic Axis

8.3. Z/Y magnetic axis



Figure 8: Z/Y Magnetic Axis

9. Pin Definitions and Descriptions

9.1. Pin Definition for SOIC-8

Pin #	Name	Description
1	VSS	Supply Ground
2	NC	Not Used
3	TEST	Test Pin
4	NC	Not Used
5	OUT2	Analog Output SIN
6	VDD5V	Supply 5V
7	VDD3V3	Supply 3V3
8	OUT1	Analog Output COS

Table 4: Pin Definition SOIC-8

For optimal EMC behavior connect the test pin and unused pins (Not Used) to the Ground.

Important: for 5V-mode applications, leave the VDD3V3 floating. Check the section 13 “Recommended Application Diagrams” for more details.

9.2. Pin Definition for TSSOP-16

Pin #	Name	Description
1	VSS_A	Supply Ground Die A
2	NC	Not Used
3	NC	Not Used
4	TEST_A	Test Pin Die A
5	OUT2_B	Analog Output SIN Die B
6	VDD5V_B	Supply 5V Die B
7	VDD3V3_B	Supply 3V3 Die B
8	OUT1_B	Analog Output COS Die B
9	VSS_B	Supply Ground Die B
10	NC	Not Used
11	TEST_B	Test Pin Die B
12	NC	Not Used
13	OUT2_A	Analog Output SIN Die A
14	VDD5V_A	Supply 5V Die A
15	VDD3V3_A	Supply 3V3 Die A
16	OUT1_A	Analog Output COS Die A

Table 5: Pin Definition TSSOP-16

For optimal EMC behavior connect the test pin and unused pins (Not Used) to the Ground.

Important: for 5V applications, leave the VDD3V3 floating. Check the section “Recommended Application Diagrams” for more details.

10. Absolute Maximum Ratings

Parameter	Symbol	Min.	Max.	Unit	Condition
Supply Voltage (5V)	V _{DD5V}	-16	24	V	
Supply Voltage (3.3V)	V _{DD3V3}	-0.3	7	V	
Supply Current ⁽⁵⁾	I _{DD}	-10	10	mA	Excluding external load on OUT1&2.
Negative Output Voltage	V _{OUT}	-0.3	-	V	
Positive Output Voltage (5V Application Diagram)	V _{OUT}	-	18	V	
Positive Output Voltage (3.3V Application Diagram)	V _{OUT}	-	17	V	
Output Current	I _{OUT}	-20	20	mA	
Operating Temperature Range	T _A	-40	150	°C	
Maximum Junction Temperature	T _J	-	165	°C	
Storage Temperature Range	T _S	-55	165	°C	
ESD Sensitivity (Human Body Model) AEC-Q100-002 standard	ESD _{HBM}	-	2	kV	Valid for SOIC-8. TSSOP-16 cross die ESD limit is 1.5kV.
ESD Sensitivity (Charged Device Model) AEC-Q100-011 standard	ESD _{CDM}	-	500	V	
Maximum Flux Density	B	-1	1	T	

Table 6: Absolute Maximum Ratings

Exceeding the absolute maximum ratings may cause permanent damage. Exposure to absolute maximum-rated conditions for extended periods may affect device reliability.

11. General Electrical Specifications

Operating Characteristics, V_{DD}=3.135V to 3.6V or V_{DD}=4.5V to 5.5V (depending on the option code), T_A = -40°C to 150°C (unless otherwise specified)

Electrical Parameter	Symbol	Min.	Typ.	Max.	Unit	Condition
Supply Voltage (operating)	V _{DD3V3}	3.135	3.3	3.6	V	SOIC-8 and TSSOP-16 packages
Supply Voltage (operating)	V _{DD5V}	4.5	5	5.5	V	SOIC-8 and TSSOP-16 packages
Supply Current	I _{DD}	5	-	9	mA	Excluding external load on OUT1&2 3.135 ≤ V _{DD} ≤ 3.6
		6	-	10	mA	4.5 ≤ V _{DD} ≤ 5.5

⁵ Note I_{DD} may exceed 10mA with a pull-down on OUT1&2.

Electrical Parameter	Symbol	Min.	Typ.	Max.	Unit	Condition
Power On Reset Voltage Rising	VPOR_H	2.4	2.75	3	V	OUT HiZ → operating mode
		2.9	3.4	3.9	V	Application Diagram VDD3V3 Application Diagram VDD5V
Power On Reset Voltage Falling	VPOR_L	2.1	2.4	2.7	V	Operating mode → OUT HiZ
		2.5	3.05	3.5	V	Application Diagram VDD3V3 Application Diagram VDD5V
Programming Voltage (PTC)	MT7V	6.1	6.5	7	V	Rising Entry Level on VDD
Load Current Range	IOUT	-1	-	1	mA	
Load Resistance Range ⁽⁶⁾	RL	10	-	∞	kΩ	Connected between OUT and GND
		5	-	∞	kΩ	Application Diagram VDD3V3 Application Diagram VDD5V
Load Capacitor Range	CL	1.5	2.2	10	nF	Connected between OUT and GND
Output Voltage Range	Vo	5	-	95	%VDD	Linearity better than 1.5%
		10	-	90	%VDD	Linearity better than 0.5%
Output Resistance	ROUT	-	25	-	Ω	IOUT= ±1mA
Power-On Time ⁽⁷⁾	ton	-	-	200	μs	High bandwidth programming VPOR_H ≤ VDD ≤ VDD5V_Max VPOR_H ≤ VDD ≤ VDD3V3_Max
Chopping Frequency	FCHOP	0.9	1	1.1	MHz	
Output Update Period	Ts	-	4	-	μs	Each field component takes 2μs, measured sequentially
Output Noise Voltage ⁽⁸⁾	Vnrms	-	-	3.1	mV	RMS noise, B=0mT, VDD = typical value S=1 %VDD/mT (50mV/mT at VDD=5V)
		-	-	4.6	mV	Low bandwidth programming
		-	-	10	mV	Medium bandwidth programming High bandwidth programming
Nyquist Frequency	Fnyq	-	125	-	kHz	
Tracking Delay ⁽⁹⁾		-	12	17.5	μs	High bandwidth
		-	29.5	38	μs	Medium bandwidth
		-	74	85.5	μs	Low bandwidth

Table 7 General Electrical Specifications

⁶ A Pull down enables EEPROM error detection when the output goes in HiZ mode.

⁷ Lower bandwidth programming increases the Power-On Time by the tracking delay (see footnote 9).

⁸ Higher sensitivity programming may increase the output noise voltage.

⁹ Tracking Delay is defined as the time delay between a rotating magnetic stimuli and the change on both outputs, SIN and COS. This delay includes the sample and hold filter which can be programmed by the customer according to the following equation: $V_o = V_i/n + n z^{-1} V_o/n$ with $\text{Bandwidth} = 1/(2\pi n T_s)$ and $n=1, 2, \dots, 16$.

12. Magnetic Specifications⁽¹⁰⁾

Operating Characteristics, VDD=3.135V to 3.6V or VDD=4.5V to 5.5V (depending on the option code), T_A = -40°C to 150°C (unless otherwise specified).

Magnetic Parameter	Symbol	Min.	Typ.	Max.	Unit	Condition
Full Scale Magnetic Range (programmable)	Bfs	10	-	70	mT	
Magnetic Flux Density	Bz	-	-	140	mT	
Sensitivity ⁽¹¹⁾	S	-	1 ⁽¹²⁾	-	%VDD/mT	xx0: 40mT magnetic range
		-	4 ⁽¹²⁾	-	%VDD/mT	xx1: 10mT magnetic range ⁽¹³⁾
		-	2 ⁽¹²⁾	-	%VDD/mT	xx2: 20mT magnetic range
		-	1.33 ⁽¹²⁾	-	%VDD/mT	xx3: 30mT magnetic range
		-	0.8 ⁽¹²⁾	-	%VDD/mT	xx4: 50mT magnetic range
		-	0.66 ⁽¹²⁾	-	%VDD/mT	xx5: 60mT magnetic range
		-	0.57 ⁽¹²⁾	-	%VDD/mT	xx6: 70mT magnetic range
		-	2.66 ⁽¹²⁾	-	%VDD/mT	xx7: 15mT magnetic range ⁽¹⁴⁾
Sensitivity Accuracy		-5	-	5	%	X/Y magnetic axis
		-8	-	8	%	Z magnetic axis T _A =25°C, V _{DD} =V _{DDNOM} , S=1%VDD/mT
Sensitivity Temperature Coefficient ⁽¹⁵⁾	TCS	-	350	-	ppm/°C	First Order approximation SmCo
		-	1100	-	ppm/°C	NdFeB
		-	2000	-	ppm/°C	Ferrite
Sensitivity Temperature Coefficient Drift	TCSdrift	-500	-	500	ppm/°C	Temperature drift around programmed TCS
Sensitivity Ratiometry		-2.5	-	2.5	% / V	
Linearity		-0.5	-	0.5	%	V _{DD} =5V, output voltage within [0.5V;4.5V]
		-0.5	-	0.5	%	V _{DD} =3.3V, output voltage within [0.33V;2.97V]
		-1.5	-	1.5	%	V _{DD} =5V, output voltage within [0.25V;4.75V]
		-1.5	-	1.5	%	V _{DD} =3.3V, output voltage in [0.165V;3.135V]
Sensitivity Mismatch		-5	-	5	%	X vs. Y, with/without gain adjustment
		-	-20	-	%	Z vs. X, Z vs. Y, without gain adjustment
		-5	-	5	%	Z vs. X, Z vs. Y, with gain adjustment

¹⁰ Please refer to the [User_Interface_description_MLX90380_PSF_sample.xls.pdf](#) for customer programmable parameters.

¹¹ Sensitivity and associated magnetic full scale range are factory programmed (see Option Codes).

¹² For option code x3x and x4x the sensitivity for the Z axis is half of the sensitivity for the X or Y axis. The given figure is for the X or Y axis.

¹³ for 3.3V operating supply voltage only

¹⁴ for 5V operating supply voltage only

¹⁵ See section 12.1 for second order behavior.

Magnetic Parameter	Symbol	Min.	Typ.	Max.	Unit	Condition
Output Offset Level	Voq	47.5	50	52.5	%VDD	B=0mT, T _A =25°C
Output Offset Temperature Drift ⁽¹⁶⁾		-1.5 -2.2	0	1.5 2.2	%VDD %VDD	V _{DD} =5V V _{DD} =3.3V B=0mT, S=1 %VDD/mT
Output Offset Ratiometry		-2.5	-	2.5	%	B=0mT (dV _{OQ} / V _{OQ}) - (dV _{DD} / V _{DD}) -10% < dV _{DD} /V _{DD} < 10%
Magnetic Angular Speed		0	-	25000	rpm	
Signal Phase Shift	PHI	-	1.8	-	Degree	At 25000 rpm, high bandwidth programming
Output Update Rate		-	1.6	-	Sample/ Degree	At 25000 rpm, high bandwidth programming
Total Angular Error without Correction ⁽¹⁷⁾		-10 -15	-	10 15	Degree Degree	T=25°C -40°C ≤ T ≤ 150°C
Total Angular Error with Dynamic Compensation ⁽¹⁸⁾		-1	-	1	Degree	

Table 8: Magnetic Specifications

¹⁶ See section 12.2 for the full Output Offset Temperature Drift Characteristics

¹⁷ Total angle error with an external homogeneous magnetic field stimulus. System design and manufacturing (magnet eccentricity and off-axis) may degrade the accuracy.

¹⁸ This system error budget is explained in more detail in a separate application note. It is dependent on the magnetic system and the correction algorithm of the ECU. A very popular method to reduce total angle error is offset and amplitude correction (e.g. min/max COS/SIN scaling by the system ECU after one full magnet revolution). The total angle error refers only to the linearity error associated to the MLX90380. The linearity error associated to the magnetic and mechanical (off-axis, eccentricity) design is not included and should be considered as an additional contribution. The total error can be reduced either statically (room temperature compensation) or dynamically (continuous compensation) through the off-chip signal processing performing the angular computation i.e. $\arctan(\text{OUT2}/\text{OUT1})$. The compensation is applied prior to computing the arctangent function: offset, gain and phase correction can be applied.

12.1. Sensitivity Temperature Coefficient Characteristic

The sensitivity temperature coefficient of the MLX90380 is a first order sensitivity compensation to counter the degrading of the magnets field strength over temperature. The TCS is foreseen with a target TCS of SmCo, NdFeB and Ferrite. The actual TCS of the sensor will show a small 2nd order on the target as illustrated in the figure below.



Figure 9: Target TCS vs. 2nd order TCS

12.2. Output Offset Temperature Drift Characteristic

In the Magnetic Specifications, the Output Offset Temperature Drift of the MLX90380 is specified for B=0mT, VDD=VDDNOM, S=1 %VDD/mT $-40^{\circ}\text{C} \leq T \leq 150^{\circ}\text{C}$. The charts below list the Output Offset Temperature Drift characteristics for the full magnetic range.

12.2.1. Output Offset Temperature Drift Characteristic



Figure 10: Output Offset Temperature Drift per Magnet Type

12.2.2. Output Offset Temperature Drift Characteristic vs. Sensitivity

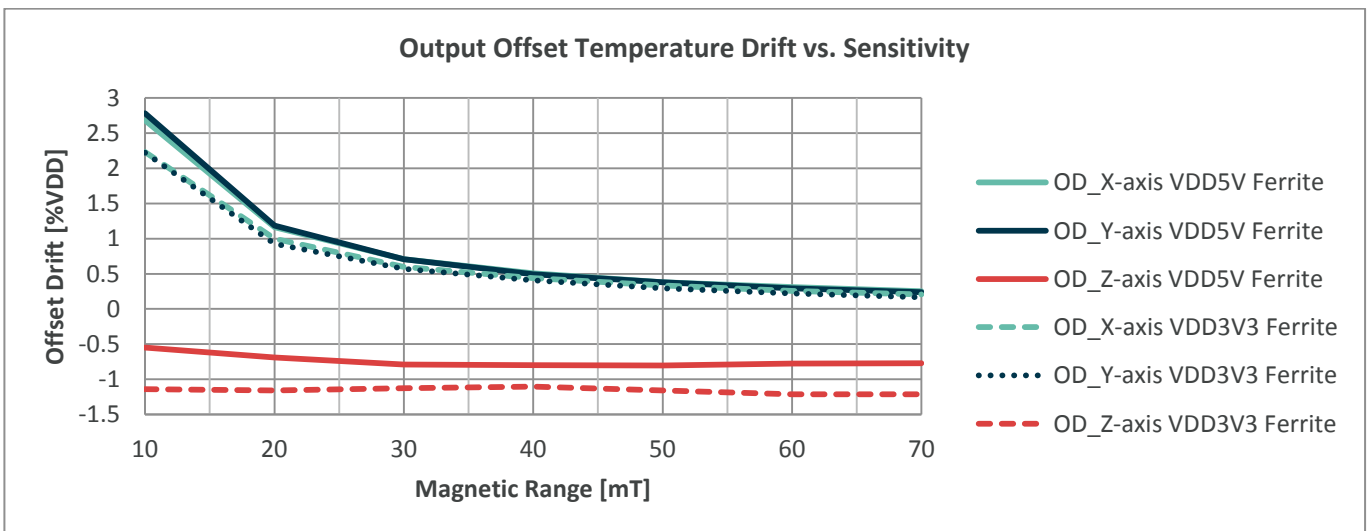
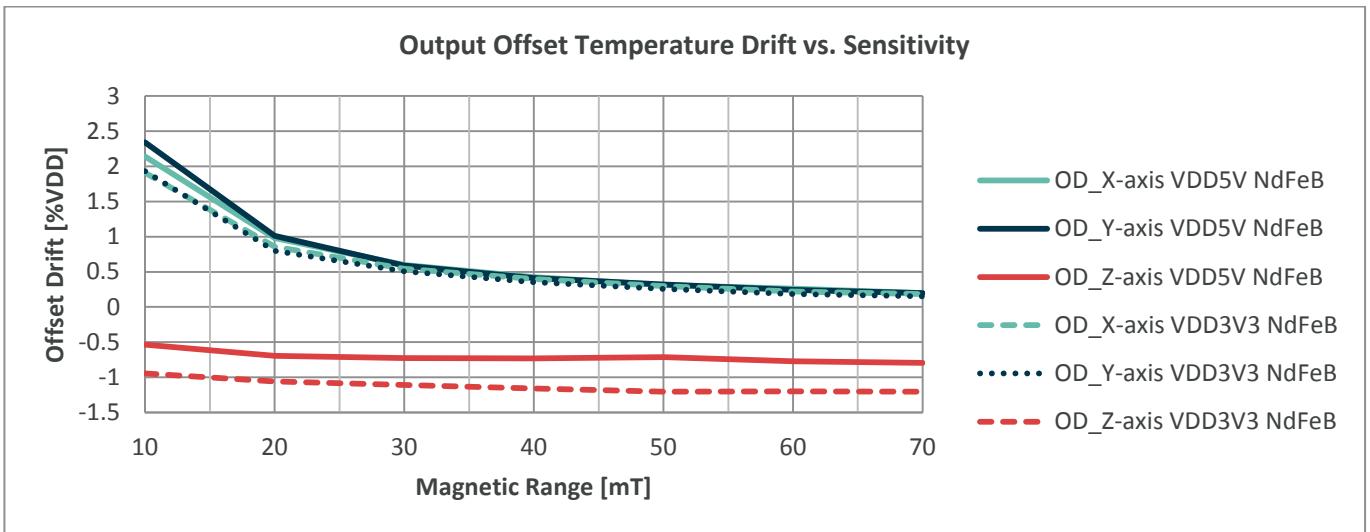
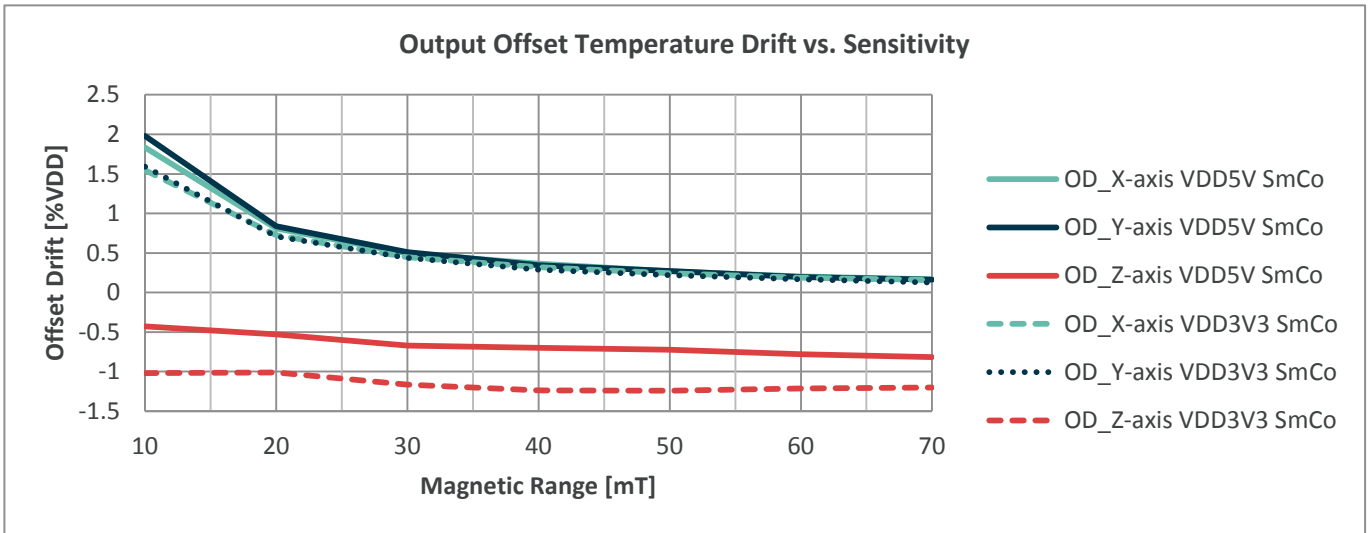

Figure 11: Output Offset Temperature Drift vs Sensitive Range per Magnet Type

13. Recommended Application Diagrams

13.1. MLX90380 in SOIC-8 Package

13.1.1. Application Diagram VDD3V3



Figure 12: Application Diagram VDD3V3

13.1.2. Application Diagram VDD5V



Figure 13: Application Diagram VDD5V

13.2. MLX90380 in TSSOP-16 Package

13.2.1. Application Diagram VDD3V3

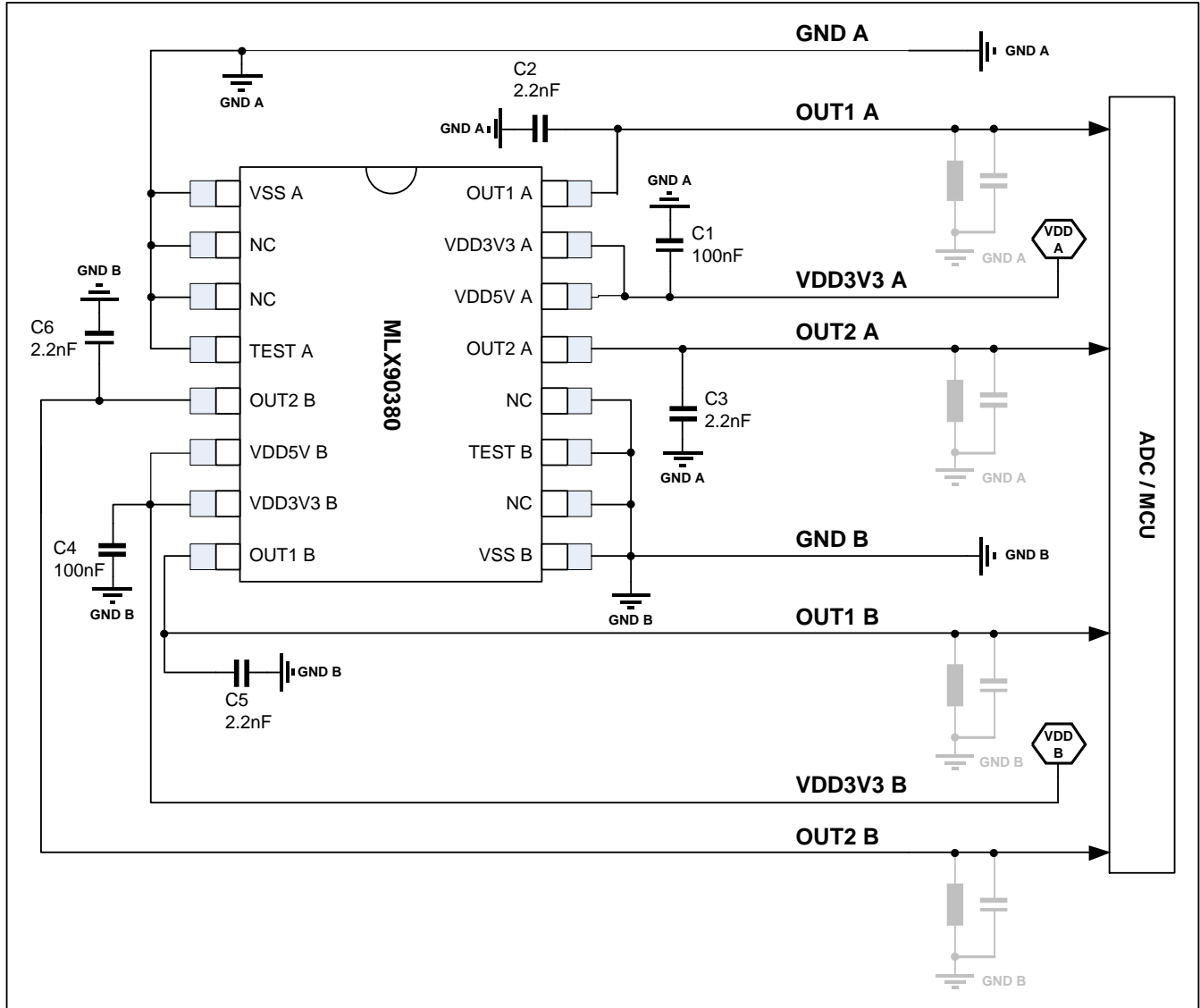

Figure 14: Application Diagram VDD3V3

13.2.2. Application Diagram VDD5V



Figure 15: Application Diagram VDD5V

14. Package Information

14.1. SOIC-8 Package Dimensions



Figure 16: SOIC-8 Package Dimensions

14.2. SOIC-8 Pin out and Marking

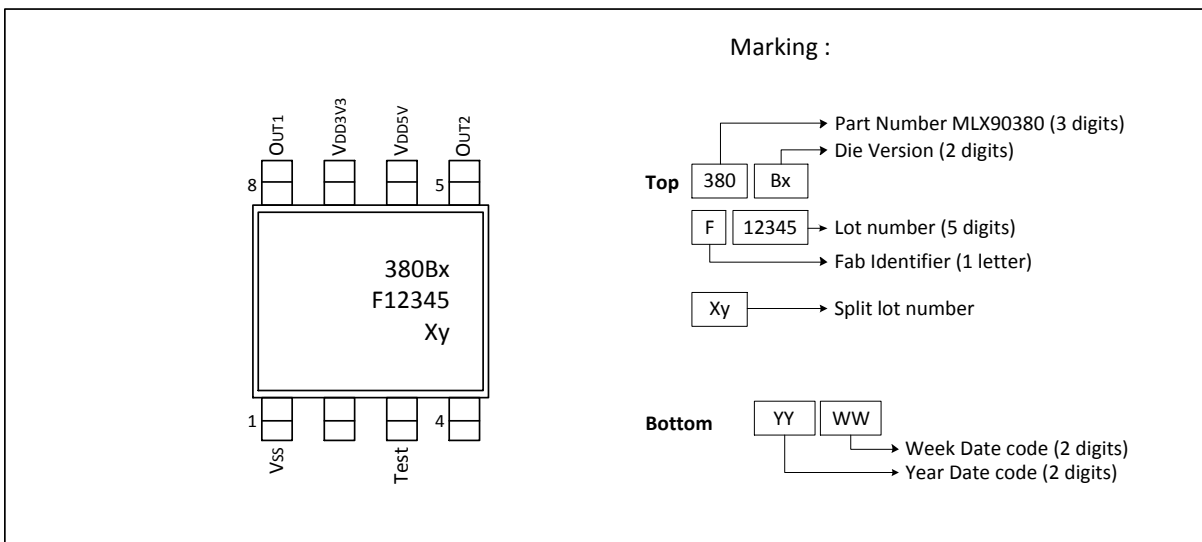

Figure 17: SOIC-8 Pin out and Marking

14.3. SOIC-8 IMC Positioning



Figure 18: SOIC-8 IMC positioning



Figure 19: Angular detection MLX90380 SOIC-8

14.4. TSSOP-16 Package Dimensions



Figure 20: TSSOP-16 Package Dimensions

14.5. TSSOP-16 Pin out and Marking

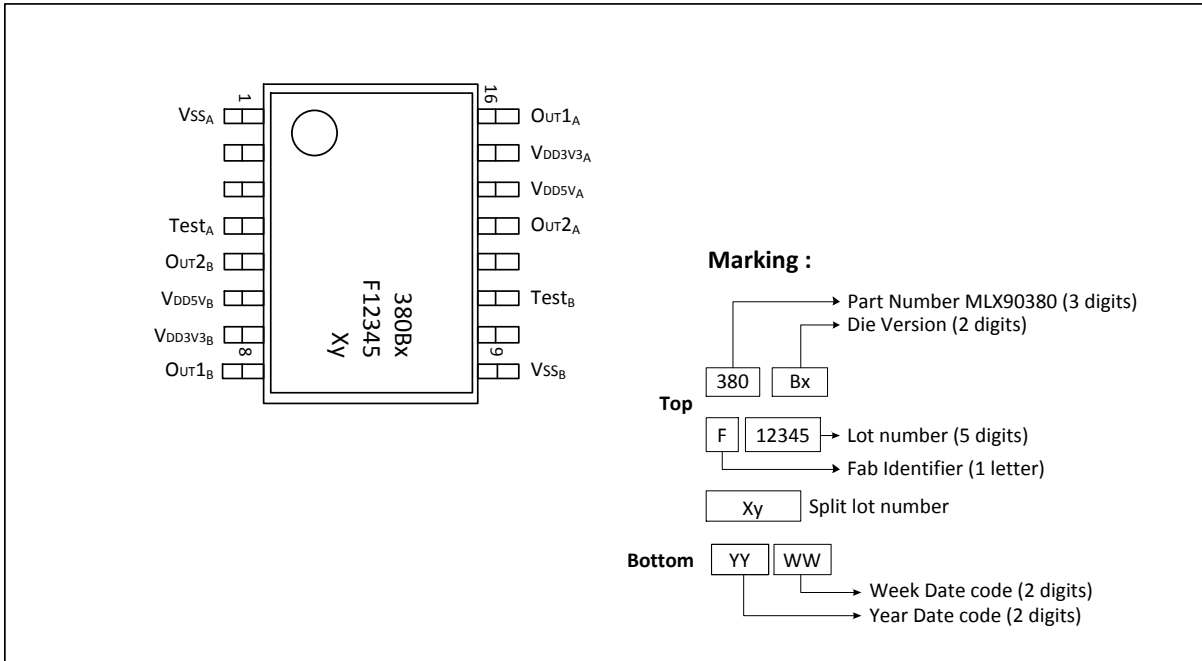

Figure 21: TSSOP-16 Pin out and Marking

14.6. TSSOP-16 IMC positioning

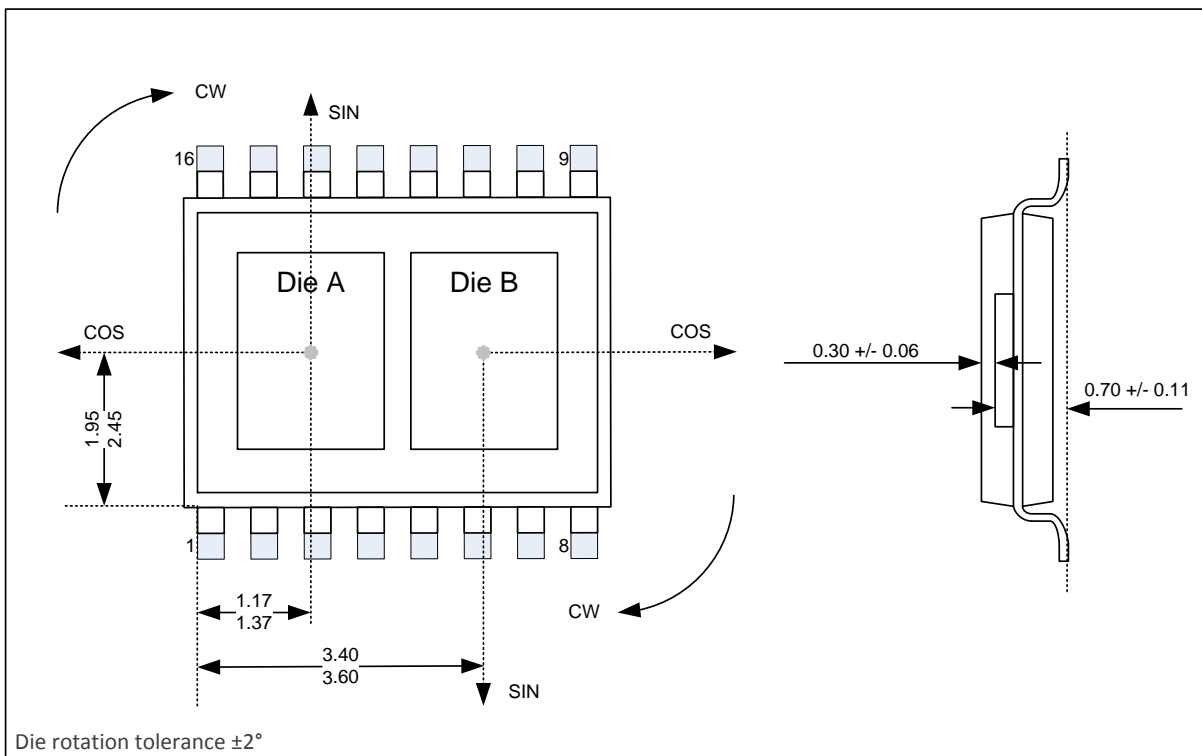

Figure 22: TSSOP-16 IMC positioning



Figure 23: Angular detection MLX90380 TSSOP-16

As illustrated above the magnetic axis of die B in the package are shifted 180° towards the magnetic axis of die A. When a magnetic angle of ~0° is applied to die A, die B will report an angle of ~180°.

15. Standard Information

Our products are classified and qualified regarding soldering technology, solder ability and moisture sensitivity level according to standards in place in Semiconductor industry.

For further details about test method references and for compliance verification of selected soldering method for product integration, Melexis recommends reviewing on our web site the General Guidelines [soldering recommendation](#). For all soldering technologies deviating from the one mentioned in above document (regarding peak temperature, temperature gradient, temperature profile etc.), additional classification and qualification tests have to be agreed upon with Melexis.

For package technology embedding trim and form post-delivery capability, Melexis recommends consulting the dedicated trim&form recommendation application note: [lead trimming and forming recommendations](#).

Melexis is contributing to global environmental conservation by promoting **lead free** solutions. For more information on qualifications of **RoHS** compliant products (RoHS = European directive on the Restriction Of the use of certain Hazardous Substances) please visit the quality page on our website: <http://www.melexis.com/en/quality-environment>.

16. ESD Precautions

Electronic semiconductor products are sensitive to Electro Static Discharge (ESD).
Always observe Electro Static Discharge control procedures whenever handling semiconductor products.

17. Contact

For the latest version of this document, go to our website at www.melexis.com.

For additional information, please contact our Direct Sales team and get help for your specific needs:

Europe, Africa	Telephone: +32 13 67 04 95
	Email : sales_europe@melexis.com
Americas	Telephone: +1 603 223 2362
	Email : sales_usa@melexis.com
Asia	Email : sales_asia@melexis.com

18. Disclaimer

The information furnished by Melexis herein ("Information") is believed to be correct and accurate. Melexis disclaims (i) any and all liability in connection with or arising out of the furnishing, performance or use of the technical data or use of the product(s) as described herein ("Product") (ii) any and all liability, including without limitation, special, consequential or incidental damages, and (iii) any and all warranties, express, statutory, implied, or by description, including warranties of fitness for particular purpose, non-infringement and merchantability. No obligation or liability shall arise or flow out of Melexis' rendering of technical or other services.

The Information is provided "as is" and Melexis reserves the right to change the Information at any time and without notice. Therefore, before placing orders and/or prior to designing the Product into a system, users or any third party should obtain the latest version of the relevant information to verify that the information being relied upon is current.

Users or any third party must further determine the suitability of the Product for its application, including the level of reliability required and determine whether it is fit for a particular purpose.

The Information is proprietary and/or confidential information of Melexis and the use thereof or anything described by the Information does not grant, explicitly or implicitly, to any party any patent rights, licenses, or any other intellectual property rights.

This document as well as the Product(s) may be subject to export control regulations. Please be aware that export might require a prior authorization from competent authorities.

The Product(s) are intended for use in normal commercial applications. Unless otherwise agreed upon in writing, the Product(s) are not designed, authorized or warranted to be suitable in applications requiring extended temperature range and/or unusual environmental requirements. High reliability applications, such as medical life-support or life-sustaining equipment are specifically not recommended by Melexis.

The Product(s) may not be used for the following applications subject to export control regulations: the development, production, processing, operation, maintenance, storage, recognition or proliferation of 1) chemical, biological or nuclear weapons, or for the development, production, maintenance or storage of missiles for such weapons; 2) civil firearms, including spare parts or ammunition for such arms; 3) defense related products, or other material for military use or for law enforcement; 4) any applications that, alone or in combination with other goods, substances or organisms could cause serious harm to persons or goods and that can be used as a means of violence in an armed conflict or any similar violent situation.

The Products sold by Melexis are subject to the terms and conditions as specified in the Terms of Sale, which can be found at <https://www.melexis.com/en/legal/terms-and-conditions>.

This document supersedes and replaces all prior information regarding the Product(s) and/or previous versions of this document.

Melexis NV © - No part of this document may be reproduced without the prior written consent of Melexis. (2018)

ISO/TS 16949 and ISO14001 Certified

X-ON Electronics

Largest Supplier of Electrical and Electronic Components

Click to view similar products for [Board Mount Motion & Position Sensors](#) category:

Click to view products by [Melexis](#) manufacturer:

Other Similar products are found below :

[SV03A103AEA01B00](#) [601HE0000B01](#) [6SS4](#) [IRA-S510ST01](#) [KMA221J](#) [XL-10043](#) [F02008062](#) [M10-JK8002C](#) [UM7-LT ORIENTATION SENSOR](#) [UM7 ORIENTATION SENSOR](#) [AMN33111J](#) [MTS-360-1A-C0000-ERA360-05E](#) [F01551006](#) [AMN11111](#) [AMN24112](#) [AMN31111](#) [AMN31112](#) [AMN34112](#) [AMN34111](#) [AMN23111](#) [SV03A103AEA01R00](#) [EKMC1693113](#) [EKMB1303111K](#) [EKMB1293112](#) [PST360-11302-1P-C0000-ERA360-24E-F100](#) [AMBA340215](#) [AMBA210205](#) [AMA115915](#) [A1324LLHLTT](#) [MLX91204KDC-ABA-001-SP](#) [EKMC1605111](#) [MLX90380LDC-BAB-120-SP](#) [02183000-000](#) [3382H-1-104](#) [EKMB1104111](#) [EKMB1204111](#) [EKMB1305111K](#) [EKMC1604112](#) [EKMB1305112K](#) [EKMB1205111](#) [EKMB1205112](#) [AMBA240202](#) [EKMB1304113K](#) [EKMB1105111](#) [EKMB1105112](#) [EKMC1693112](#) [EKMC1605112](#) [MLX90316EDC-BCG-000-SP](#) [EKMB1305113K](#) [AMBA345912](#)