

CR2330

■ Dimensions(mm)



■ Specification

Nominal voltage(V)	3
Nominal capacity(mAh)	265
Continuous drain(mA)	0.2
Operating temperature(°C)	-30 to +60

■ Discharge temperature characteristics



■ Operating voltage vs. load resistance(voltage at 50% discharge depth)



■ Capacity vs. load resistance



CR2354

■ Dimensions(mm)

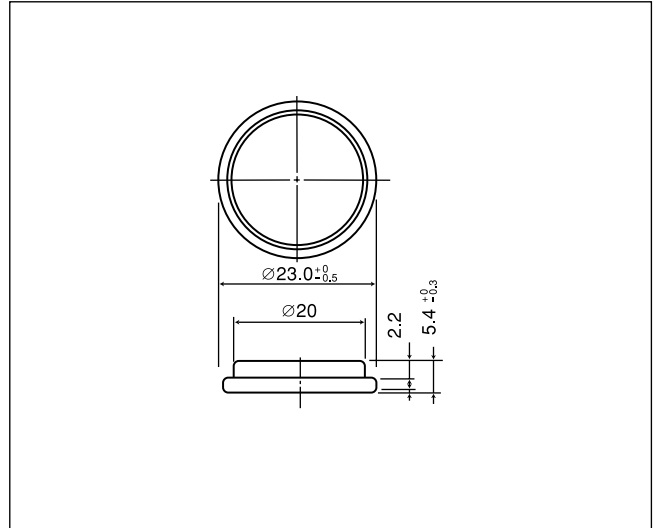

■ Specification

Nominal voltage(V)	3
Nominal capacity(mAh)	560
Continuous drain(mA)	0.2
Operating temperature(°C)	-30 to +60

■ Discharge temperature characteristics



■ Operating voltage vs. load resistance(voltage at 50% discharge depth)



■ Capacity vs. load resistance



X-ON Electronics

Largest Supplier of Electrical and Electronic Components

Click to view similar products for [Coin Cell Battery](#) category:

Other Similar products are found below :

[ERD-S1TJ8R2V](#) [DP3-22](#) [TK1-6V](#) [AH64-05846A](#) [ELL-ATV100M](#) [ERA-14EB121U](#) [ECOS1JA122BA](#) [ECW-U1C184JB9](#) [HC2-H-AC48V-F](#)
[ERA-S15J471V](#) [HC2-HP-AC115V-F](#) [ECJ-2FF1A475Z](#) [ECOS2GP271EA](#) [EYG-A091210P](#) [EEV-HB1HR22R](#) [ELC-12D471E](#) [EVM-](#)
[3RSX50B13](#) [EEF-SD0E221R](#) [EVM-1USX30B12](#) [EEF-UE0E471LR](#) [PA-LN19](#) [LCRA1212P](#) [EEF-CD0K8R2R](#) [EEF-UE0E471R](#) [HHR-](#)
[80AAAB3B](#) [ELC-10D330E](#) [ERA-V15J101V](#) [HC2-SF-K](#) [ELL-ATV331M](#) [EVQ-PSC02K](#) [EEV-TG2A220P](#) [ELL-6RH1R5M](#) [036506R](#) [ERD-](#)
[S1TJ165V](#) [LC-P127R2P](#) [ECE-V0JA220NR](#) [2SB15990QL](#) [ECOS2GP121CX](#) [EVM-3VSX50B52](#) [RP-SDME04DA1](#) [ELC-09D4R7F](#)
[ELJRF22NJFB](#) [ELJFCR82KF](#) [EVM-F6SA00B55](#) [ESE-15700](#) [EEC-S5R5H105N](#) [EEV-TG1J330P](#) [AXE260124A](#) [EEV-TG2A100P](#) [ECJ-](#)
[1VF1E683Z](#)