

REV  
NC DTM06-12S\*-E003

REVISIONS			
SYM	DESCRIPTION	DATE	APPROVED
NC	NEW RELEASE PER E.O. P17535	12-17-01	RDR

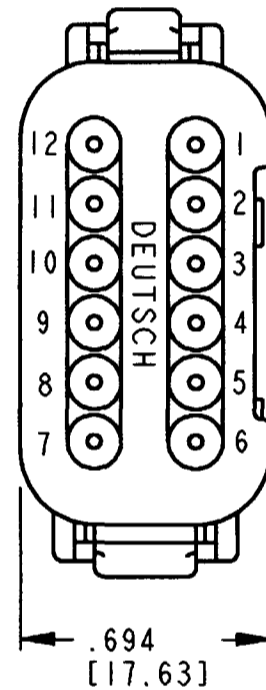

8  
END CAP

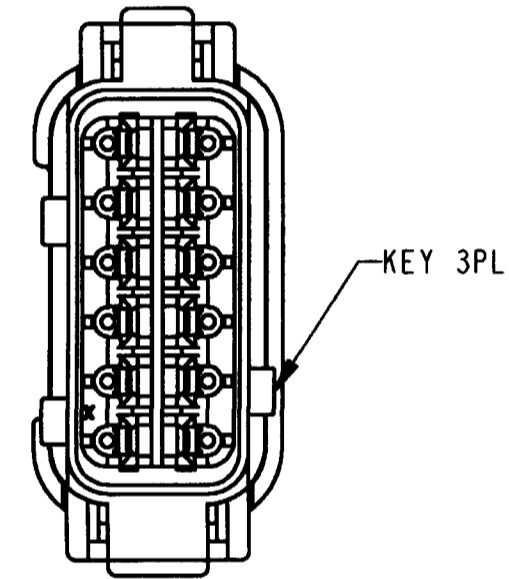
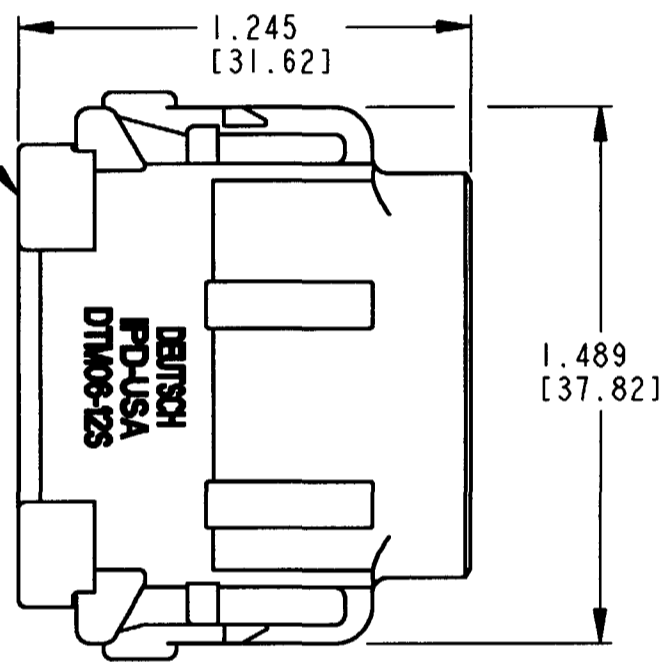

- 8. PART MODIFICATION.
  - 7. SEE SHEET 2 FOR OTHER KEY ARRANGEMENT.
  - 6. MATERIAL - HOUSING/END CAP: PLASTIC; GROMMET: RUBBER.
  - 5. THIS PLUG MATES WITH DTM04-12P\*-\*\*\*\* RECEPTACLE. (\* = A,B,C,D KEYS; \*\*\*\* = ALL MODIFICATIONS)
  - 4. FOR CONTACT AND WIRE PERFORMANCE AND APPLICATION CHARACTERISTICS SEE ENVELOPE DRAWING 0425-015-0000.
  - 3. SECONDARY WEDGE LOCK SOLD SEPARATELY: WM-12S.
  - 2. DIMENSION TOLERANCE: ±.025 [.64].
  - 1. DIMENSIONS ARE IN INCHES [mm].
- NOTES: UNLESS OTHERWISE SPECIFIED

CONTACT SIZE	MIN. INSUL. O.D.	MAX. INSUL. O.D.	WIRE RANGE [mm <sup>2</sup> ] REF ONLY
20	.053 [1.35]	.120 [3.05]	16-20 AWG [1.0-0.5]

SIGNATURE & DATE	
DR	D. MEYER 11/15/01
CHK	B. B. 12/17/01
PE	D. Meyer 12/13/01
APPD	R. Reed 12-17-01
SCALE	NONE WT

PLUG W/END CAP  
12 CONTACTS, SIZE 20  
A,B,C,D KEYS  
-E003 MOD  
DTM SERIES

CP	MATL. CODE
<b>The Deutsch Company</b> DEUTSCH I.P.D. 3850 INDUSTRIAL AVE. HEMET, CALIF. 92545	
<b>B</b> DTM06-12S*-E003	
DWG SIZE	CODE 11139 SHEET 1 OF 2

ENVELOPE

REV NC	DTM06-12S*-E003	REVISIONS		
SYM	DESCRIPTION	DATE	APPROVED	
	SEE SHEET 1	12-17-01	ROR	

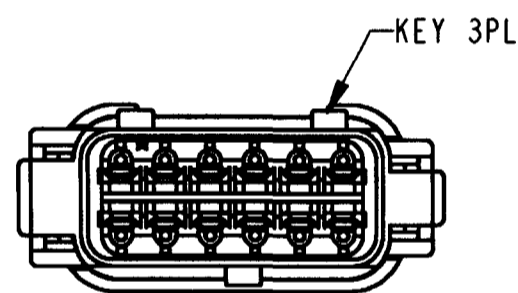
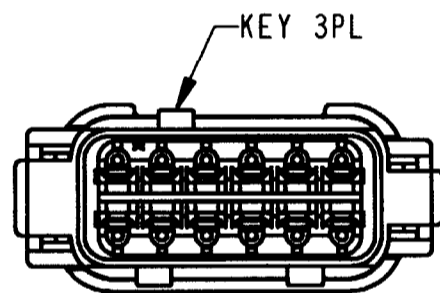
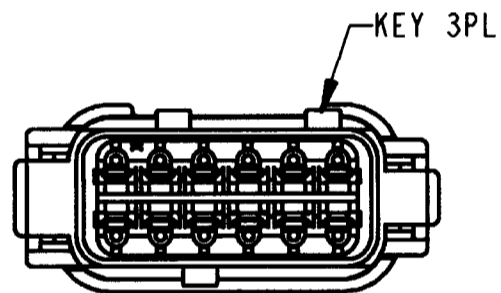
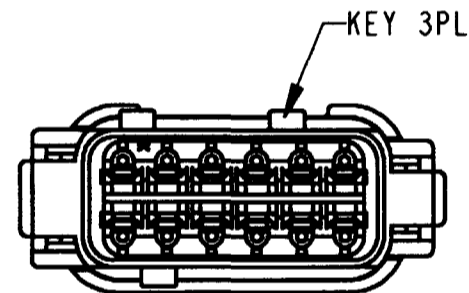
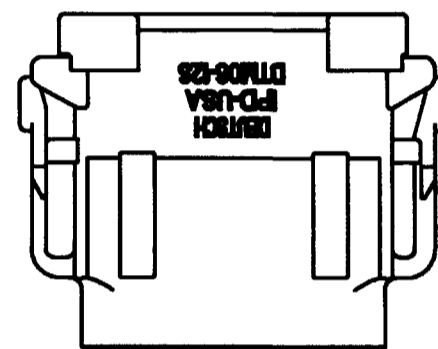
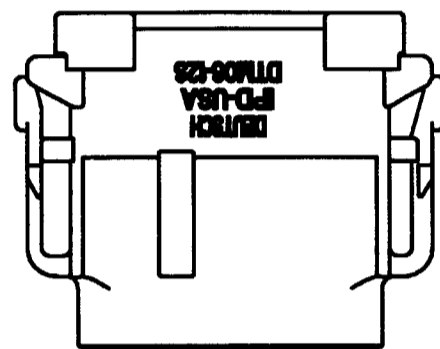
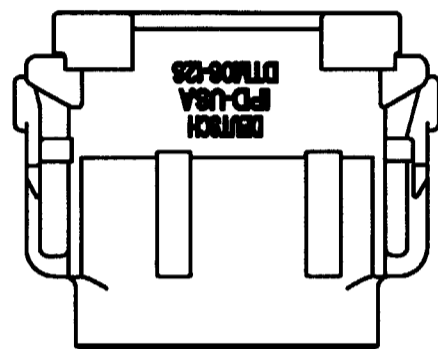
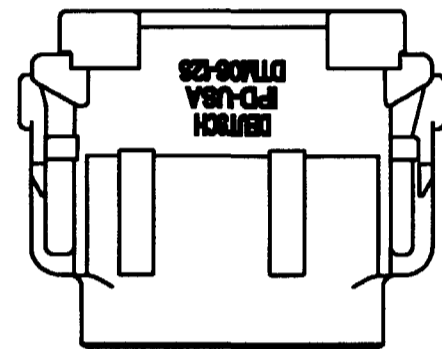

DTM06-12SA-E003  
KEY -A-  
COLOR: GREY

DTM06-12SB-E003  
KEY -B-  
COLOR: BLACK

DTM06-12SC-E003  
KEY -C-  
COLOR: GREEN

DTM06-12SD-E003  
KEY -D-  
COLOR: BROWN

NOTES:

SIGNATURE & DATE		PLUG W/END CAP 12 CONTACTS, SIZE 20 A,B,C,D KEYS -E003 MOD DTM SERIES	CP	MATL. CODE
DR	D. MEYER 11/15/01		The Deutsch Company DEUTSCH I.P.D. 3850 INDUSTRIAL AVE. HEMET, CALIF. 92545	
CHK	R. Reed 12/17/01		<b>B</b> DTM06-12S*-E003 DWG SIZE CODE SHEET 2 OF 2 11139	
PE	D. Meyer 12/13/01			
APPD	R. Reed 12-17-01	ENVELOPE		
SCALE	NONE	WT		

## X-ON Electronics

Largest Supplier of Electrical and Electronic Components

*Click to view similar products for [Automotive Connectors](#) category:*

*Click to view products by [TE Connectivity](#) manufacturer:*

Other Similar products are found below :

[003-018-000](#) [600858](#) [60403001](#) [60993906-B](#) [60993913-B](#) [629515004020001](#) [M902-2131](#) [M902-2161](#) [M902-2344](#) [72.330.1035.1](#)  
[73.353.4028.0](#) [F118010](#) [F119300-B](#) [F132210](#) [F132210-B](#) [F166900](#) [F180100](#) [F258300](#) [F258300-B](#) [F294300-B](#) [F339100](#) [F339700](#) [F358300-](#)  
[B](#) [F374110](#) [F407400](#) [F412210](#) [F427600](#) [F444110](#) [F487000](#) [F495100-B](#) [F500900-B](#) [F509500B-B](#) [770444-1](#) [776880-1](#) [827153-1](#) [881735-1](#)  
[8N1515-32-24P](#) [9-1326729-8](#) [925467-1](#) [925474-1](#) [928905-1](#) [936398-2](#) [964562-1](#) [964562-4](#) [964731-2](#) [965051-1](#) [968782-1](#) [GT17SA-8DS-](#)  
[HU](#) [GT17VS-10DP-5.2CF](#) [98315-0001](#)