



3-terminal Filters

For signal line

MEM Series

MEM2012SC Type

MEM2012SC **2012[0805 inch]***

* Dimensions Code JIS[EIA]

REMINDERS FOR USING THESE PRODUCTS

Before using these products, be sure to request the delivery specifications.

SAFETY REMINDERS

Please pay sufficient attention to the warnings for safe designing when using these products.

REMINDERS

- The storage period is less than 12 months. Be sure to follow the storage conditions (Temperature: 5 to 40°C, Humidity: 10 to 75% RH or less).
If the storage period elapses, the soldering of the terminal electrodes may deteriorate.
- Do not use or store in locations where there are conditions such as gas corrosion (salt, acid, alkali, etc.).
- Before soldering, be sure to preheat components.
The preheating temperature should be set so that the temperature difference between the solder temperature and chip temperature does not exceed 150°C.
- Soldering corrections after mounting should be within the range of the conditions determined in the specifications.
If overheated, a short circuit, performance deterioration, or lifespan shortening may occur.
- When embedding a printed circuit board where a chip is mounted to a set, be sure that residual stress is not given to the chip due to the overall distortion of the printed circuit board and partial distortion such as at screw tightening portions.
- Self heating (temperature increase) occurs when the power is turned ON, so the tolerance should be sufficient for the set thermal design.
- Carefully lay out the coil for the circuit board design of the non-magnetic shield type.
A malfunction may occur due to magnetic interference.
- Use a wrist band to discharge static electricity in your body through the grounding wire.
- Do not expose the products to magnets or magnetic fields.
- Do not use for a purpose outside of the contents regulated in the delivery specifications.
- The products listed on this catalog are intended for use in general electronic equipment (AV equipment, telecommunications equipment, home appliances, amusement equipment, computer equipment, personal equipment, office equipment, measurement equipment, industrial robots) under a normal operation and use condition.
The products are not designed or warranted to meet the requirements of the applications listed below, whose performance and/or quality require a more stringent level of safety or reliability, or whose failure, malfunction or trouble could cause serious damage to society, person or property.
If you intend to use the products in the applications listed below or if you have special requirements exceeding the range or conditions set forth in the each catalog, please contact us.

(1) Aerospace/Aviation equipment
 (2) Transportation equipment (cars, electric trains, ships, etc.)
 (3) Medical equipment
 (4) Power-generation control equipment
 (5) Atomic energy-related equipment
 (6) Seabed equipment
 (7) Transportation control equipment

(8) Public information-processing equipment
 (9) Military equipment
 (10) Electric heating apparatus, burning equipment
 (11) Disaster prevention/crime prevention equipment
 (12) Safety equipment
 (13) Other applications that are not considered general-purpose applications

When designing your equipment even for general-purpose applications, you are kindly requested to take into consideration securing protection circuit/device or providing backup circuits in your equipment.

3-terminal Filters

For signal line

Product compatible with RoHS directive

Halogen-free

Compatible with lead-free solders

Overview of MEM2012SC Type

FEATURES

- Multilayer chip EMC filter.
- Monolithic structure makes it highly reliable.
- Closed magnetic circuit structure makes it possible to achieve high-density mounting without crosstalk.
- Has sharp attenuation characteristics with excellent EMC suppression.
- Wide range of products compatible with passing frequencies and attenuating frequencies.
- T-type circuit is used.
- Compatible with 1A current.

APPLICATION

Noise removal from signal lines of data terminals, digital cameras, computers, game machines, flat TVs, etc.

PART NUMBER CONSTRUCTION

MEM	2012		SC	100		T	001	
Series name	LxWxT Dimensions (mm)		Product internal code	Capacitance (pF) at 1MHz		Packaging style		Internal code
	2012	2.0x1.25x0.8	SC	100	10	T	Taping	
				101	100			

OPERATING TEMPERATURE RANGE, PACKAGE QUANTITY, PRODUCT WEIGHT

Type	Temperature range		Package quantity (pieces/reel)	Individual weight (mg)
	Operating temperature (°C)	Storage temperature* (°C)		
MEM2012SC	-40 to +85	-40 to +85	4,000	8

* The Storage temperature range is for after the circuit board is mounted.

- RoHS Directive Compliant Product: See the following for more details related to RoHS Directive compliant products. <http://product.tdk.com/en/environment/rohs/>
- Halogen-free: Indicates that Cl content is less than 900ppm, Br content is less than 900ppm, and that the total Cl and Br content is less than 1500ppm.

 Please be sure to request delivery specifications that provide further details on the features and specifications of the products for proper and safe use. Please note that the contents may change without any prior notice due to reasons such as upgrading.

MEM2012SC Type

RECOMMENDED REFLOW PROFILE

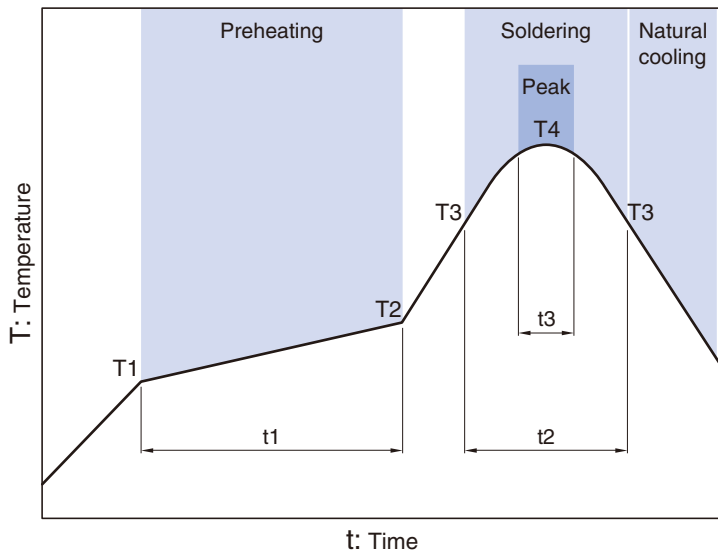

Preheating			Soldering		Peak	
Temp.	Time		Temp.	Time	Temp.	Time
T1	T2	t1	T3	t2	T4	t3
150°C	180°C	60 to 120s	230°C	30 to 60s	250 to 260°C	10s max.

 Please be sure to request delivery specifications that provide further details on the features and specifications of the products for proper and safe use. Please note that the contents may change without any prior notice due to reasons such as upgrading.

MEM2012SC Type

SHAPE & DIMENSIONS

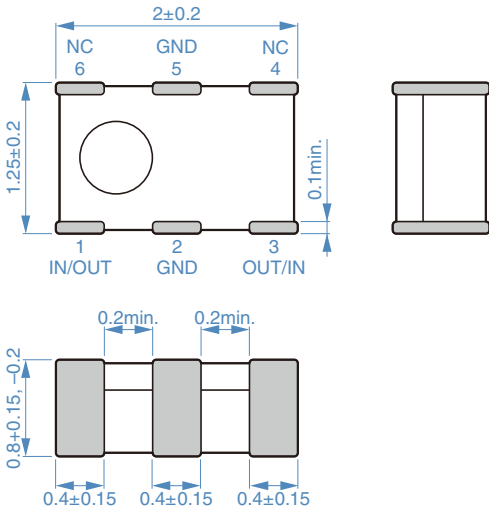

Dimensions in mm

RECOMMENDED LAND PATTERN

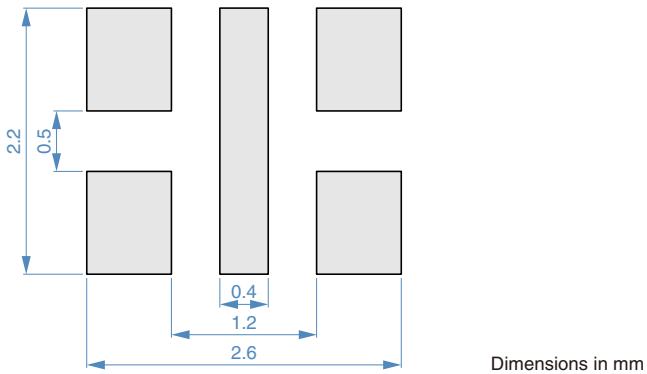

Dimensions in mm

CIRCUIT DIAGRAM

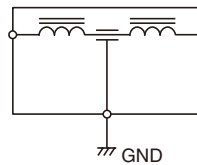

 Please be sure to request delivery specifications that provide further details on the features and specifications of the products for proper and safe use. Please note that the contents may change without any prior notice due to reasons such as upgrading.

MEM2012SC Type

ELECTRICAL CHARACTERISTICS

CHARACTERISTICS SPECIFICATION TABLE

Capacitance*	Tolerance	Rated voltage	Rated current	DC resistance	Part No.
(pF)	(%)	(V)max.	(A)max.	[Terminal No.1 to 3] (Ω)max.	
10	± 30	12	1	0.15	MEM2012SC100T001
22	± 30	12	1	0.15	MEM2012SC220T001
47	± 30	12	1	0.15	MEM2012SC470T001
100	± 30	12	1	0.15	MEM2012SC101T001
150	± 30	12	1	0.15	MEM2012SC151T001

* Measuring frequency: 1(MHz), measuring voltage: 1(V)

○ Measurement equipment

Measurement item	Product No.	Manufacturer
Capacitance	4294A	Agilent Technologies
Frequency characteristics	N5230C	Agilent Technologies

* Equivalent measurement equipment may be used.

INSERTION LOSS VS. FREQUENCY CHARACTERISTICS

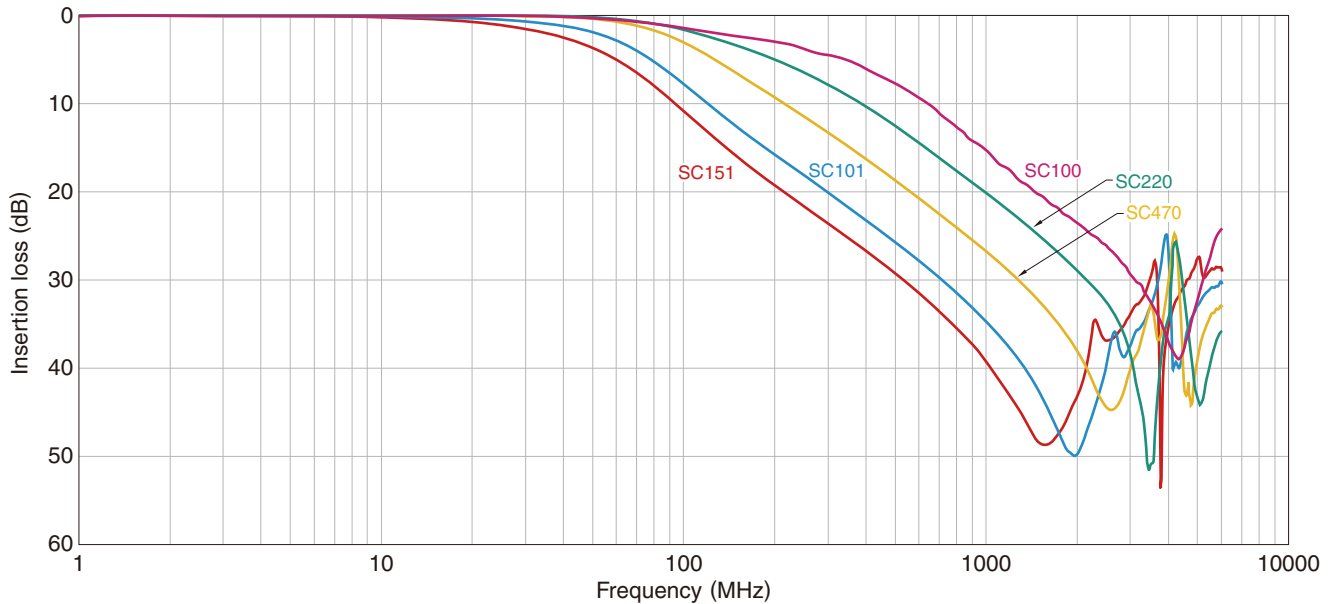

○ Measurement equipment

Product No.	Manufacturer
N5230C	Agilent Technologies

* Equivalent measurement equipment may be used.

 Please be sure to request delivery specifications that provide further details on the features and specifications of the products for proper and safe use. Please note that the contents may change without any prior notice due to reasons such as upgrading.

X-ON Electronics

Largest Supplier of Electrical and Electronic Components

Click to view similar products for [EMI Filter Circuits](#) category:

Click to view products by [TDK](#) manufacturer:

Other Similar products are found below :

[EMI2180MTTBG](#) [EMI8041BMUTAG](#) [CM1442-08CP](#) [CSPEMI204FCTAG](#) [SBSPP1000152MXT](#) [SBSGC5000473MXT](#)
[SBSMC0500474MXT](#) [EMI8043MUTAG](#) [1-6609037-5](#) [BNX022-01L](#) [BNX024H01L](#) [NZF220DFT1G](#) [MEM2012SC151T001](#)
[MEA2010PE150T001](#) [MEA1608PE220TA0G](#) [MEA1608LC150T001](#) [742730023](#) [MEM2012F101R](#) [NFA21SL287V1A45L](#)
[MEM1608P101RT001](#) [SBSMP1000224MXT](#) [SBSMC5000683MXT](#) [SBSMC0500474MXB](#) [SBSGP1000104MXB](#) [SBSGP1000104MXT](#)
[SBSGC5000102MXB](#) [MEM2012V301R](#) [MEM1608P75R0T001](#) [NFA18SD187X1A45L](#) [VEMI355A-HAF-G-08](#) [4420P-601-250/181](#)
[EMI220T-RC](#) [EMI221T-RC](#) [EMI271T-RC](#) [EMI470T-RC](#) [EMI101T-RC](#) [EMI222T-RC](#) [SBSMP0500474MXB](#) [SBSGC0500224MXT](#)
[BNP002-02](#) [BNP002-03](#) [BNX002-11](#) [BNX003-11](#) [BNX005-11](#) [BNX012-01](#) [NFA18SL407V1A45L](#) [NFA21SL317V1A45L](#)
[NFW31SP206X1E4L](#) [NFW31SP506X1E4L](#) [IP4254CZ16-8-TTL,1](#)