

**C×R3 type,  
VSSOP package,  
20 V load voltage**

**PhotoMOS®  
RF VSSOP 1 Form A C×R3  
(AQY22○○○T)**

**New**

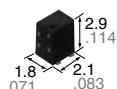

mm inch

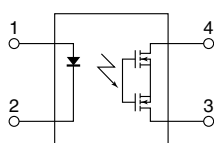

**RoHS compliant**

### FEATURES

#### 1. Miniature VSSOP package

4.6 mm<sup>2</sup> mounting area achieved. Approx 29% less than previous product (SON type).

Contributes to the miniaturization of instruments and higher density mounting.

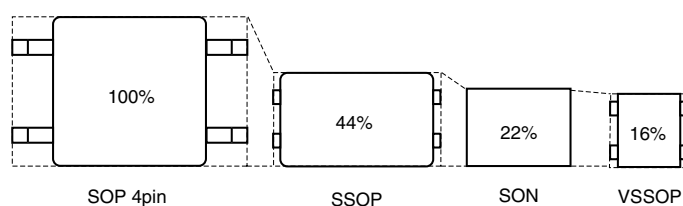

#### 2. Load voltage: 20 V

#### 3. Low C×R (C×R3)

Output capacitance: 1.1 pF (typical), On resistance: 2.8Ω (typical)

### TYPICAL APPLICATIONS

#### 1. Measuring and testing equipment

IC tester, Probe card, Board tester and other testing equipment

#### 2. Telecommunication equipment

\*Does not support automotive applications.

### TYPES

Type	Output rating*1		Part No. (Tape and reel packing style)*2		Packing quantity in the tape and reel
	Load voltage	Load current	Picked from the 1 and 4-pin side	Picked from the 2 and 3-pin side	
AC/DC dual use	<b>New</b> 20 V	180 mA	AQY221N5TY	AQY221N5TW	1,000 pcs.

Notes: \*1. Indicate the peak AC and DC values.

\*2. Only tape and reel package is available.

For space reasons, only "1N5" is marked on the product as the part number.

## RATING

### 1. Absolute maximum ratings (Ambient temperature: 25°C 77°F)

Item	Symbol	AQY221N5T	Remarks	
Input side	LED forward current	$I_F$	50 mA	
	LED reverse voltage	$V_R$	5 V	
	Peak forward current	$I_{FP}$	1 A	f = 100 Hz, Duty factor = 0.1%
	Power dissipation	$P_{in}$	75 mW	
Output side	Load voltage (peak AC)	$V_L$	20 V	
	Continuous load current	$I_L$	0.18 A	Peak AC, DC
	Power dissipation	$P_{out}$	250 mW	
Total power dissipation	$P_T$	300 mW		
I/O isolation voltage	$V_{iso}$	200 V AC		
Operating temperature	$T_{opr}$	-40°C to +85°C -40°F to +185°F	Non-condensing at low temperatures	
Storage temperature	$T_{stg}$	-40°C to +100°C -40°F to +212°F		

### 2. Electrical characteristics (Ambient temperature: 25°C 77°F)

Item	Symbol	AQY221N5T	Condition		
Input	LED operate current	Typical	0.7 mA	$I_L = 80$ mA	
		Maximum	3 mA		
	LED turn off current	Minimum	0.2 mA		
		Typical	0.6 mA		
	LED dropout voltage	Typical	1.14 V (1.35 V at $I_F = 50$ mA)		$I_F = 5$ mA
Maximum		1.5 V			
Output	On resistance	Typical	2.8 $\Omega$	$I_F = 5$ mA, $I_L = 80$ mA Within 1 s on time	
		Maximum	4.5 $\Omega$		
	Output capacitance	Typical	1.1 pF	$I_F = 0$ mA, f = 1 MHz, $V_B = 0$ V	
		Maximum	1.5 pF		
	Off state leakage current	Typical	0.01 nA	$I_F = 0$ mA, $V_L = \text{Max.}$	
		Maximum	10 nA*		
Transfer characteristics	Turn on time**	Typical	0.02 ms	$I_F = 5$ mA, $V_L = 10$ V, $R_L = 125$ $\Omega$	
		Maximum	0.2 ms		
	Turn off time**	Typical	0.01 ms		
		Maximum	0.2 ms		
	I/O capacitance	Typical	0.4 pF		f = 1 MHz, $V_B = 0$ V
		Maximum	1.5 pF		

Notes: 1. Please refer to the "Schematic and Wiring Diagrams" for connection method.

2. Variation possible through combinations of output capacitance and on resistance. For more information, please contact our sales office in your area.

\*Available as custom orders (1 nA or less)

\*\*Turn on/Turn off time

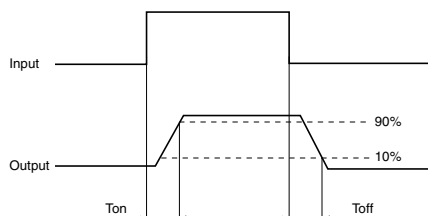

## RECOMMENDED OPERATING CONDITIONS

Please obey the following conditions to ensure proper this device operation and resetting.

Item	Symbol	Recommended value	Unit
Input LED forward current	$I_F$	5	mA

## REFERENCE DATA

### 1. Load current vs. ambient temperature characteristics

Allowable ambient temperature: -40°C to +85°C  
-40°F to +185°F

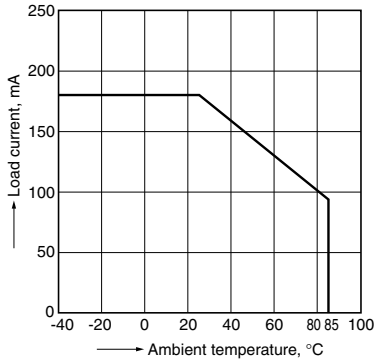

### 2. Load current vs. load voltage characteristics

Ambient temperature: 25°C 77°F

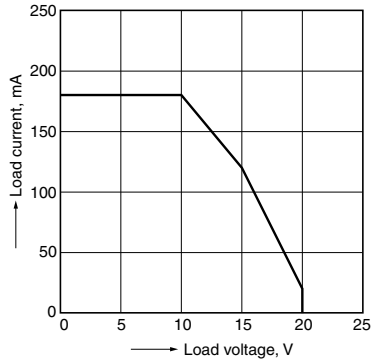

### 3. On resistance vs. ambient temperature characteristics

Measured portion: between terminals 3 and 4  
LED current: 5 mA; Load voltage: 10V (DC)  
Continuous load current: 80mA (DC)

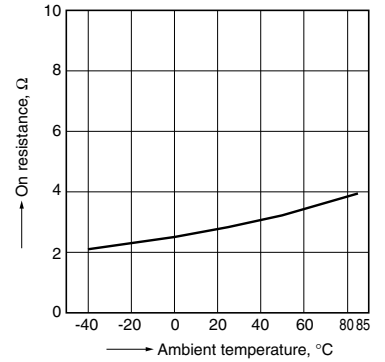

### 4. Turn on time vs. ambient temperature characteristics

LED current: 5 mA; Load voltage: 10V (DC);  
Continuous load current: 80mA (DC)

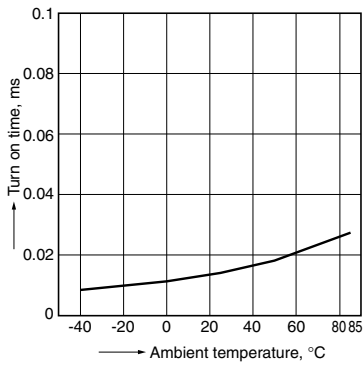

### 5. Turn off time vs. ambient temperature characteristics

LED current: 5 mA; Load voltage: 10V (DC);  
Continuous load current: 80mA (DC)

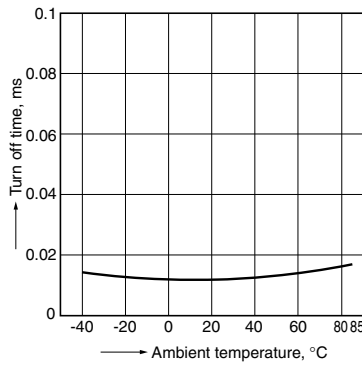

### 6. LED operate current vs. ambient temperature characteristics

Load voltage: 10V (DC);  
Continuous load current: 80mA (DC)

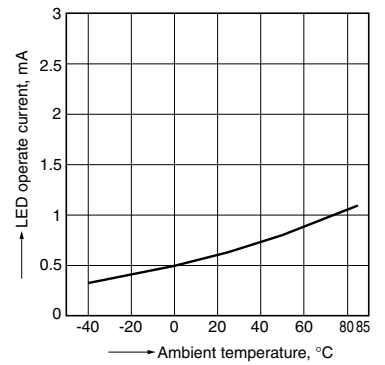

### 7. LED turn off current vs. ambient temperature characteristics

Load voltage: 10V (DC);  
Continuous load current: 80mA (DC)

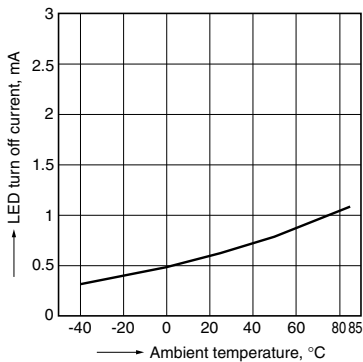

### 8. LED dropout voltage vs. ambient temperature characteristics

LED current: 5 to 50 mA

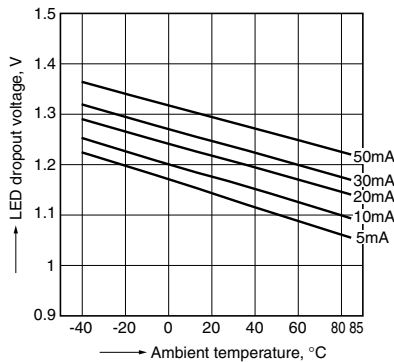

### 9. Current vs. voltage characteristics of output at MOS portion

Measured portion: between terminals 3 and 4;  
Ambient temperature: 25°C 77°F

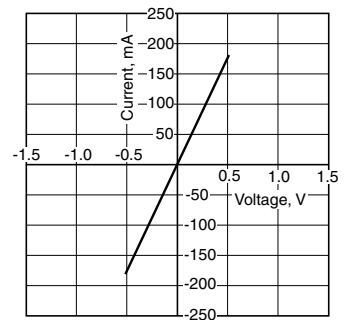

# RF VSSOP 1 Form A C×R3 (AQY22○○○T)

## 10. Off state leakage current vs. load voltage characteristics

Measured portion: between terminals 3 and 4;  
Ambient temperature: 25°C 77°F

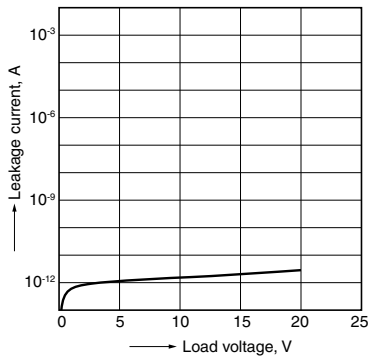

## 11. Turn on time vs. LED forward current characteristics

Measured portion: between terminals 3 and 4;  
Load voltage: 10V (DC); Continuous load current: 80mA (DC); Ambient temperature: 25°C 77°F

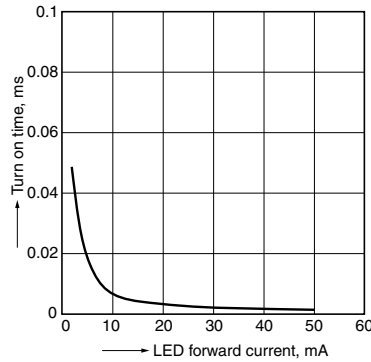

## 12. Turn off time vs. LED forward current characteristics

Measured portion: between terminals 3 and 4;  
Load voltage: 10V (DC); Continuous load current: 80mA (DC); Ambient temperature: 25°C 77°F

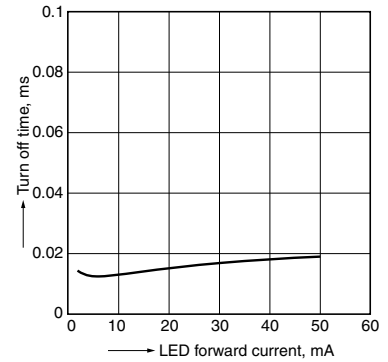

## 13. Output capacitance vs. applied voltage characteristics

Measured portion: between terminals 3 and 4;  
Frequency: 1 MHz; Ambient temperature: 25°C 77°F

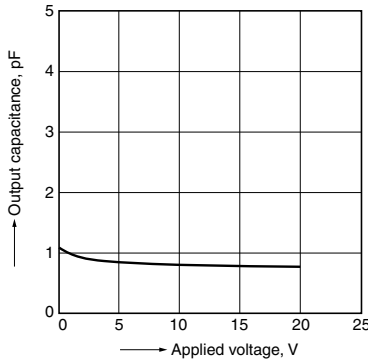

## 14. Isolation vs. frequency characteristics (50Ω impedance)

Measured portion: between terminals 3 and 4;  
Ambient temperature: 25°C 77°F

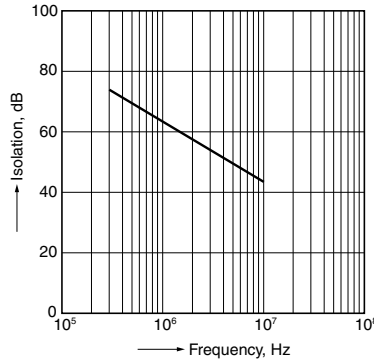

## 15. Insertion loss vs. frequency characteristics (50Ω impedance)

Measured portion: between terminals 3 and 4;  
Ambient temperature: 25°C 77°F

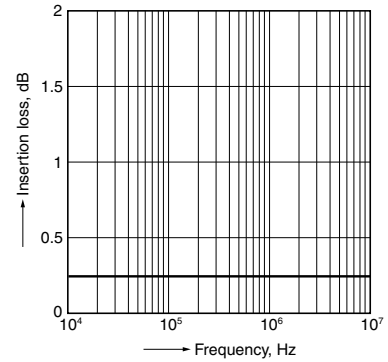

## 16. On resistance distribution

Measured portion: between terminals 3 and 4  
Continuous load current: 80 mA (DC), n: 50pcs.  
Ambient temperature: 25°C 77°F

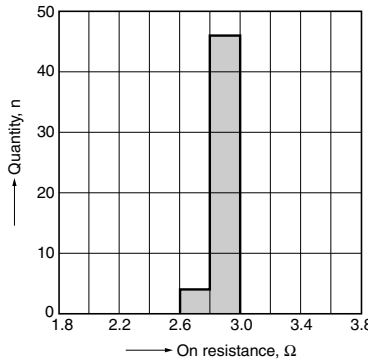

## 17. Turn on time distribution

Load voltage: 10V (DC)  
Continuous load current: 80 mA (DC), n: 50pcs.  
Ambient temperature: 25°C 77°F

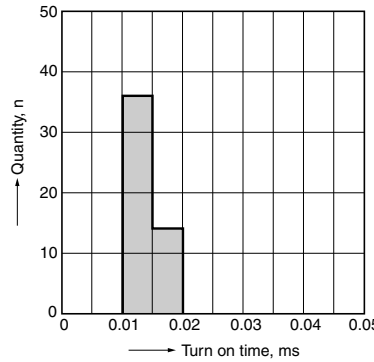

## 18. Turn off time distribution

Load voltage: 10V (DC)  
Continuous load current: 80 mA (DC), n: 50pcs.  
Ambient temperature: 25°C 77°F

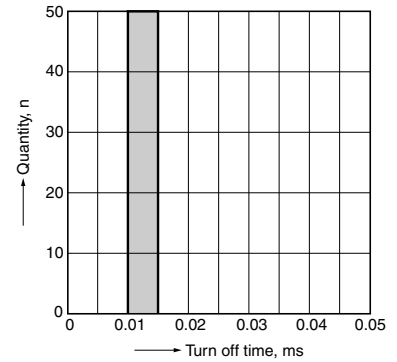

## 19. LED operate current distribution

Load voltage: 10V (DC)  
Continuous load current: 80 mA (DC), n: 50pcs.  
Ambient temperature: 25°C 77°F

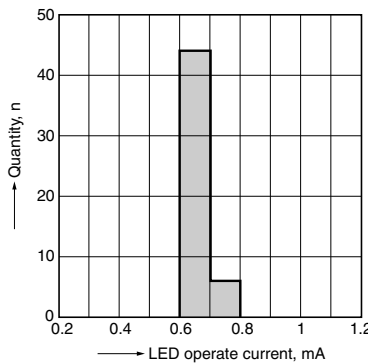

**DIMENSIONS** (mm inch)

The CAD data of the products with a **CAD Data** mark can be downloaded from: <http://industrial.panasonic.com/ac/e/>

**CAD Data**



External dimensions

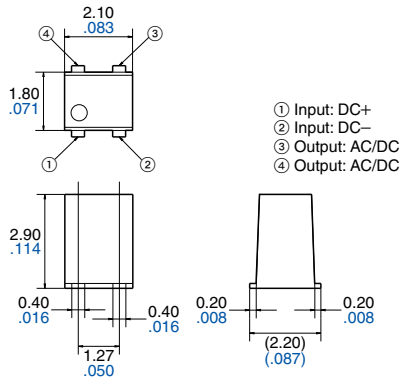

Recommended mounting pad (Top view)

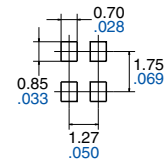

Tolerance:  $\pm 0.1 \pm .004$

General tolerance:  $\pm 0.1 \pm .004$

**SCHEMATIC AND WIRING DIAGRAMS**

$E_1$ : Power source at input side,  $I_F$ : LED forward current,  $V_L$ : Load voltage,  $I_L$ : Load current

Schematic	Output configuration	Load	Connection	Wiring diagram
	1a	AC/DC	—	

## PhotoMOS® CAUTIONS FOR USE

### SAFETY WARNINGS

• Do not use the product under conditions that exceed the range of its specifications. It may cause overheating, smoke, or fire.

• Do not touch the recharging unit while the power is on. There is a danger of electrical shock. Be sure to turn off the power when performing mounting, maintenance, or repair operations on the device (including connecting parts such as the terminal board and socket).

• Check the connection diagrams in the catalog and be sure to connect the terminals correctly. Erroneous connections could lead to unexpected operating errors, overheating, or fire.

#### 1. Derating design

Derating is essential in any reliable design and is a significant factor for product life.

Even if the conditions of use (temperature, current, voltage, etc.) of the product fall within the absolute maximum ratings, reliability can be reduced remarkably when used under high load (high temperature, high humidity, high current, high voltage, etc.).

Therefore, please derate sufficiently below the absolute maximum rating and verify operation of the actual design before use.

Also, if there is the possibility that the inferior quality of this product could possibly cause great adverse affect on human life or physical property we recommend that, from the perspective of a manufacturer's liability, sufficient amount of derating to be added to the maximum rating value and implement safety measures such as fail-safe circuit.

#### 2. Applying stress that exceeds the absolute maximum rating

If the voltage or current value for any of the terminals exceeds the absolute maximum rating, internal elements will deteriorate because of the excessive voltage or current. In extreme cases, wiring may melt, or silicon P/N junctions may be destroyed.

Therefore, the circuit should be designed in such a way that the load never exceed the absolute maximum ratings, even momentarily.

#### 3. Deterioration and destruction caused by discharge of static electricity

##### (RF C×R3 / C×R5 / C×R10)

This phenomenon is generally called static electricity destruction, and occurs when static electricity generated by various factors is discharged while the PhotoMOS® terminals are in contact, producing internal destruction of the element.

To prevent problems from static electricity, the following precautions and measures should be taken when using your device.

1) Employees handling PhotoMOS® should wear anti-static clothing and should be grounded through protective resistance of 500 kΩ to 1 MΩ.

2) A conductive metal sheet should be placed over the worktable. Measuring instruments and jigs should be grounded.

3) When using soldering irons, either use irons with low leakage current, or ground the tip of the soldering iron. (Use of low-voltage soldering irons is also recommended.)

4) Devices and equipment used in assembly should also be grounded.

5) When packing printed circuit boards and equipment, avoid using high-polymer materials such as foam styrene, plastic, and other materials which carry an electrostatic charge.

6) When storing or transporting devices, the environment should not be conducive to generating static electricity (for instance, the humidity should be between 45 and 60%), and PhotoMOS® should be protected using conductive packing materials.

#### 4. Short across terminals

Do not short circuit between terminals when PhotoMOS® is energized, since there is possibility of breaking of the internal IC.

#### 5. Output spike voltages

1) If an inductive load generates spike voltages which exceed the absolute maximum rating, the spike voltage must be limited. Typical circuits are shown below.

(Typical circuits of AC/DC dual use type are shown below. It is the same with DC only type.)

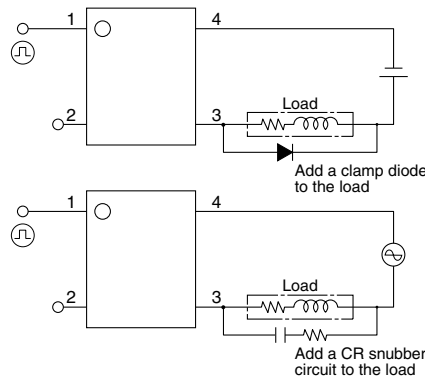

2) Even if spike voltages generated at the load are limited with a clamp diode if the circuit wires are long, spike voltages will occur by inductance. Keep wires as short as possible to minimize inductance.

#### 6. Ripple in the input power supply

If ripple is present in the input power supply, observe the following:

1) For LED forward current at  $E_{min}$ , please maintain min. 5 mA.

2) Please make sure for  $E_{max}$  is no higher the LED current at than 50 mA.

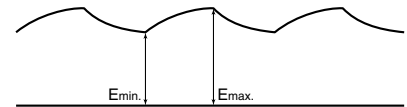

#### 7. About the exposed terminals on the sides of the package

As shown in the following figure, part of the input and output frames are exposed on the sides of the package. Due to this, please be keep in mind the cautions listed below.

1) Shorting the exposed terminals may cause deterioration of the insulation between the inputs and outputs, and may damage the internal IC.

2) Since the exposed terminals are connected electrically to the internal element, please refer to item "3. Deterioration and destruction caused by discharge of static electricity", and implement sufficient measures to control static electricity.

3) When mounting the PhotoMOS® in the vicinity, please keep in mind that if the exposed frames of adjacent PhotoMOS® get too close, a short between PhotoMOS® may occur.

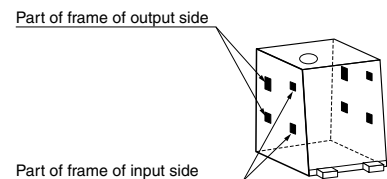

#### 8. Regarding close installations

When many PhotoMOS® are mounted close to other parts, the ambient temperature may rise due to heating of the internal element when power is applied. Be sure to use with a reduced load current after testing under actual conditions, because the degree of temperature rise depends on the mounting layout of the PhotoMOS® and conditions of use.

**9. Soldering**

1) When soldering PC board terminals, keep soldering time to within 10 s at 260°C 500°F.

2) When soldering surface-mount terminals, SOP, SSOP, SON and VSSOP package, the following conditions are recommended.

(1) IR (Infrared reflow) soldering method

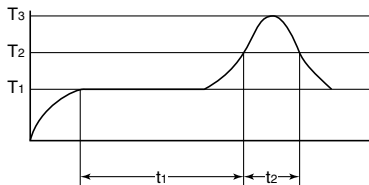

T<sub>1</sub> = 150 to 180°C 302 to 356°F  
 T<sub>2</sub> = 230°C 446°F  
 T<sub>3</sub> = 250°C 482°F or less\*  
 t<sub>1</sub> = 60 to 120 s or less  
 t<sub>2</sub> = 30 s or less

\*245°C 473°F or less for SON, VSSOP package

(2) Soldering iron method

Tip temperature: 350 to 400°C 662 to 752°F

Wattage: 30 to 60 W

Soldering time: within 3 s

(3) Others

Check mounting conditions before using other soldering methods (DWS, VPS, hot-air, hot plate, laser, pulse heater, etc.)

- When using lead-free solder, we recommend a type with an alloy composition of Sn 3.0 Ag 0.5 Cu. Please inquire about soldering conditions and other details.

- The temperature profile indicates the temperature of the soldered terminal on the surface of the PC board. The ambient temperature may increase excessively. Check the temperature under mounting conditions.

**10. Notes for mounting**

1) If many different packages are combined on a single substrate, then lead temperature rise is highly dependent on package size. For this reason, please make sure that the temperature of the terminal solder area of the PhotoMOS<sup>®</sup> falls within the temperature conditions of item "9. Soldering" before mounting.

2) If the mounting conditions exceed the recommended solder conditions in item "9. Soldering", resin strength will fall and the nonconformity of the heat expansion coefficient of each constituent material will increase markedly, possibly causing cracks in the package, severed bonding wires, and the like. For this reason, please inquire with us about whether this use is possible.

**11. Cleaning solvents compatibility**

We recommend cleaning with an organic solvent. If you cannot avoid using ultrasonic cleansing, please ensure that the following conditions are met, and check beforehand for defects.

- Frequency: 27 to 29 kHz
- Ultrasonic output: No greater than 0.25W/cm<sup>2</sup>
- Cleaning time: No longer than 30 s
- Cleanser used: Asahiklin AK-225
- Others: Submerge in solvent in order to prevent the PC board and elements from being contacted directly by the ultrasonic vibrations.

Note: Applies to unit area ultrasonic output for ultrasonic baths.

**12. Transportation and storage**

1) Extreme vibration during transport will warp the lead or damage the PhotoMOS<sup>®</sup>. Handle the outer and inner boxes with care.

2) Storage under extreme conditions will cause soldering degradation, external appearance defects, and deterioration of the characteristics. The following storage conditions are recommended:

- Temperature: 0 to 45°C 32 to 113°F
- Humidity: Less than 70% R.H.
- Atmosphere: No harmful gasses such as sulfurous acid gas, minimal dust.

3) PhotoMOS<sup>®</sup> implemented in VSSOP, SON, SSOP, SOP are sensitive to moisture and come in sealed moisture-proof package. Observe the following cautions on storage.

- After the moisture-proof package is unsealed, take the devices out of storage as soon as possible (within 1 month ≦ 45°C 32°F/70%R.H.).
- If the devices are to be left in storage for a considerable period after the moisture-proof package has been unsealed, it is recommended to keep them in another moisture-proof bag containing silica gel (within 3 months at the most).

# RF VSSOP 1 Form A C×R3 (AQY22○○○OT)

## 13. The following shows the packaging format

### 1) Tape and reel (Unit: mm inch)

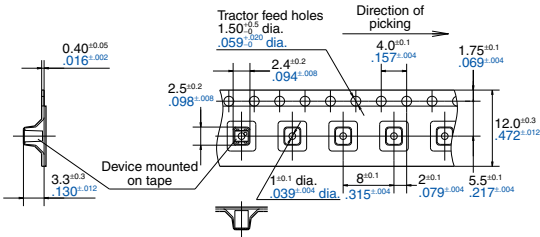
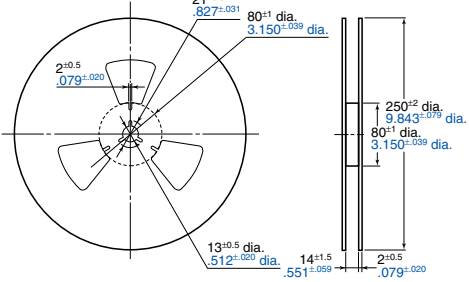
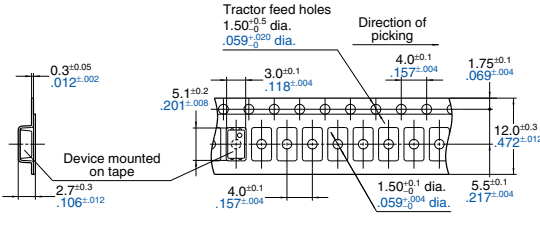
Type	Tape dimensions	Dimensions of paper tape reel
<p>VSSOP 4-pin</p>	 <p>Tractor feed holes 1.50<sup>+0.05</sup> dia. / .059<sup>+0.003</sup> dia.</p> <p>Direction of picking</p> <p>Device mounted on tape</p> <p>Dimensions: 0.40<sup>+0.05</sup> / .016<sup>+0.002</sup>, 2.5<sup>+0.2</sup> / .098<sup>+0.008</sup>, 2.4<sup>+0.2</sup> / .094<sup>+0.008</sup>, 4.0<sup>+0.1</sup> / .157<sup>+0.004</sup>, 1.75<sup>+0.1</sup> / .069<sup>+0.004</sup>, 12.0<sup>+0.3</sup> / .472<sup>+0.012</sup>, 3.3<sup>+0.3</sup> / .130<sup>+0.012</sup>, 1.0<sup>+0.1</sup> dia. / .039<sup>+0.004</sup> dia., 8<sup>+0.1</sup> / .315<sup>+0.004</sup>, 2<sup>+0.1</sup> / .079<sup>+0.004</sup>, 5.5<sup>+0.1</sup> / .217<sup>+0.004</sup></p> <p>(1) When picked from 1 and 4-pin side: Part No. AQY○○○OTY (Shown above)            (2) When picked from 2 and 3-pin side: Part No. AQY○○○OTW</p>	 <p>Dimensions: 21<sup>+0.8</sup> / .827<sup>+0.031</sup>, 80<sup>+1</sup> dia. / 3.150<sup>+0.039</sup> dia., 2<sup>+0.5</sup> / .079<sup>+0.020</sup>, 250<sup>+12</sup> dia. / 9.843<sup>+0.079</sup> dia., 80<sup>+1</sup> dia. / 3.150<sup>+0.039</sup> dia., 13<sup>+0.5</sup> dia. / .512<sup>+0.020</sup> dia., 14<sup>+1.5</sup> / .551<sup>+0.059</sup>, 2<sup>+0.5</sup> / .079<sup>+0.020</sup></p>
<p>SSOP 4-pin</p>	 <p>Tractor feed holes 1.50<sup>+0.05</sup> dia. / .059<sup>+0.003</sup> dia.</p> <p>Direction of picking</p> <p>Device mounted on tape</p> <p>Dimensions: 0.3<sup>+0.05</sup> / .012<sup>+0.002</sup>, 5.1<sup>+0.2</sup> / .201<sup>+0.008</sup>, 3.0<sup>+0.1</sup> / .118<sup>+0.004</sup>, 4.0<sup>+0.1</sup> / .157<sup>+0.004</sup>, 1.75<sup>+0.1</sup> / .069<sup>+0.004</sup>, 12.0<sup>+0.3</sup> / .472<sup>+0.012</sup>, 2.7<sup>+0.3</sup> / .106<sup>+0.012</sup>, 4.0<sup>+0.1</sup> / .157<sup>+0.004</sup>, 1.50<sup>+0.1</sup> dia. / .059<sup>+0.004</sup> dia., 5.5<sup>+0.1</sup> / .217<sup>+0.004</sup></p> <p>(1) When picked from 1 and 4-pin side: Part No. AQY221*VY (Shown above)            (2) When picked from 2 and 3-pin side: Part No. AQY221*VW</p>	<p>Dimensions of paper tape reel: 21<sup>+0.8</sup> / .827<sup>+0.031</sup>, 80<sup>+1</sup> dia. / 3.150<sup>+0.039</sup> dia., 2<sup>+0.5</sup> / .079<sup>+0.020</sup>, 250<sup>+12</sup> dia. / 9.843<sup>+0.079</sup> dia., 80<sup>+1</sup> dia. / 3.150<sup>+0.039</sup> dia., 13<sup>+0.5</sup> dia. / .512<sup>+0.020</sup> dia., 14<sup>+1.5</sup> / .551<sup>+0.059</sup>, 2<sup>+0.5</sup> / .079<sup>+0.020</sup></p>

Notes: "\*" indicates two or more characters of number or alphabet.  
 "O" indicates a single-digit figure.



## X-ON Electronics

Largest Supplier of Electrical and Electronic Components

*Click to view similar products for [Solid State Relays - PCB Mount](#) category:*

*Click to view products by [Panasonic](#) manufacturer:*

Other Similar products are found below :

[M86F-2W](#) [M90F-2W](#) [G2-1A07-ST](#) [G2-1A07-TT](#) [G2-1B02-TT](#) [G2-DA06-ST](#) [G3CN-202PL-3-US DC12](#) [G3CN-203P DC3-28](#)  
[G3RDX02SNUSDC12](#) [PLA134S](#) [DMP6202A](#) [DS11-1005](#) [AQ3A2-ZT432VDC](#) [AQV212J](#) [AQV214SD02](#) [AQV252GAJ](#) [AQW414EA](#)  
[AQY212SXT](#) [AQY221N2SJ](#) [AQY221R2SJ](#) [EFR1200480A150](#) [LCA220](#) [LCB110S](#) [1618400-5](#) [SR75-1ST](#) [AQV212AJ](#) [AQV238AD01](#)  
[AQW414TS](#) [AQY210SXT](#) [AQY212ST](#) [AQY214SXT](#) [AQY221N2V1YJ](#) [AQY275AXJ](#) [G2-1A02-ST](#) [G2-1A02-TT](#) [G2-1A03-ST](#) [G2-1A03-](#)  
[TT](#) [G2-1A05-ST](#) [G2-1A06-TT](#) [G2-1A23-TT](#) [G2-1B01-ST](#) [G2-1B01-TT](#) [G2-1B02-ST](#) [G2-DA03-ST](#) [G2-DA03-TT](#) [G2-DA06-TT](#) [G3M-](#)  
[203PL-UTU-1 DC24](#) [CPC2330N](#) [3-1617776-2](#) [CTA2425](#)