

PTC thermistors for overcurrent protection and as inrush current limiters

Leaded disks, 260 V up to 1000 V

Series/Type: B597**C0... / B594**C1...

Date: February 2018

© EPCOS AG 2018. Reproduction, publication and dissemination of this publication, enclosures hereto and the information contained therein without EPCOS' prior express consent is prohibited.

EPCOS AG is a TDK Group Company.

Overcurrent protection and inrush current limiting

Leaded disks, 260 V up to 1000 V

Applications

- Inrush current limiter for smoothing and DC link capacitors
- To replace high-power fixed resistors for capacitor charging
- Overcurrent and short circuit protection

Features

- Lead-free terminals
- Self-protecting in case of malfunction of short-circuit relay or internal short circuit of capacitor
- Inrush current limiters are not damaged when directly connected to V_{max} even without additional current limitation
- Marking: Type, manufacturer's logo, reference temperature in °C and date code YYWW
- UL approval to UL 1434 (file number E69802) for ICL application selected types; $V_{max} = 480$ V and $V_R = 400$ V for C755
- UL approval to UL 1434 (file number E69802) for overcurrent protection $V_{max} = 420$ V and $V_R = 380$ V, except type C758, C1412 and C1451
- VDE approval (licence number 40040539) for ICL applications and for overcurrent protection selected types (licence number 104843)
- IECQ certificate (file number 101-QA-13) for ICL applications and for overcurrent protection selected types (file number 101-QA-2)
- Qualification based on AEC-Q200, Rev. D for B59412C1130B070 and B59451C1130B070
- RoHS-compatible

Delivery mode

- Cardboard strips (standard)
- Cardboard tape reeled or in Ammo pack on request

Dimensional drawing with coating, C14** and C7**

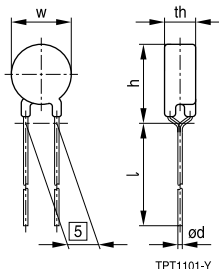

Dimensional drawing without coating, B750 and B770

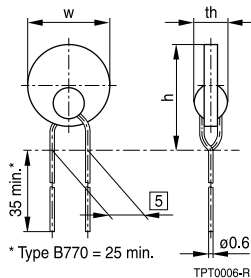

* Type B770 = 25 min.

Dimensions in mm

| Type | w_{max} | h_{max} | l_{min} | th_{max} | $\varnothing d$ |
|-------|-----------|-----------|-----------|------------|-----------------|
| B750 | 12.5 | 16.5 | 35 | 5.0 | 0.6 |
| B770 | 8.5 | 12.0 | 25 | 7.0 | 0.6 |
| C1412 | 15.0 | 19.0 | 35 | 7.5 | 0.8 |
| C1451 | 15.0 | 19.0 | 35 | 7.5 | 0.8 |
| C750 | 13.0 | 18.0 | 35 | 5.5 | 0.6 |
| C751 | 13.0 | 18.0 | 35 | 7.5 | 0.6 |
| C752 | 13.0 | 18.0 | 25 | 7.5 | 0.6 |
| C753 | 13.0 | 18.0 | 25 | 7.5 | 0.6 |
| C754 | 13.0 | 18.0 | 25 | 7.5 | 0.6 |
| C755 | 13.0 | 18.0 | 35 | 7.5 | 0.6 |
| C758 | 13.0 | 18.0 | 35 | 7.5 | 0.6 |
| C770 | 9.0 | 13.5 | 25 | 7.5 | 0.6 |
| C771 | 9.0 | 13.5 | 25 | 7.5 | 0.6 |
| C772 | 9.0 | 13.5 | 25 | 7.5 | 0.6 |
| C773 | 9.0 | 13.5 | 25 | 7.5 | 0.6 |
| C774 | 9.0 | 13.5 | 25 | 7.5 | 0.6 |



Overcurrent protection and inrush current limiting

Leaded disks, 260 V up to 1000 V

General technical data for inrush current limiters

| | | | | |
|--------------------------------|-------------------------|----------|-----------|--------|
| Operating cycles at V_{\max} | (charging of capacitor) | N_c | > 100.000 | cycles |
| Switching cycles at V_{\max} | (failure mode) | N_f | > 100 | cycles |
| Operating temperature range | ($V = 0$) | T_{op} | -40/+125 | °C |
| Operating temperature range | ($V = V_{\max}$) | T_{op} | -20/+85 | °C |

Electrical specifications and ordering codes for inrush current limiters

| Type | V_{\max} | $V_{link,max}$ | R_R | ΔR_R | T_{ref} | C_{th} | τ_{th} | Circuit diagram | Approvals | | Ordering code |
|-------|------------|----------------|----------|--------------|--------------|----------|-------------|-----------------|---|---|-----------------|
| | V AC | V DC | Ω | % | (typ.) °C | J/K | s | |  |  | |
| C770 | 260 | 370 | 70 | ±25 | 120 | 0.4 | 70 | 2 | — | — | B59770C0120A070 |
| C771 | 260 | 370 | 120 | ±25 | 120 | 0.6 | 80 | 2 | — | — | B59771C0120A070 |
| C772 | 260 | 370 | 150 | ±25 | 120 | 0.6 | 80 | 2 | — | — | B59772C0120A070 |
| C750 | 280 | 400 | 25 | ±25 | 120 | 1.0 | 100 | 2 | X | X | B59750C0120A070 |
| C751 | 280 | 400 | 50 | ±25 | 120 | 1.4 | 120 | 2 | X | X | B59751C0120A070 |
| C752 | 280 | 400 | 80 | ±25 | 120 | 1.4 | 120 | 2 | X | X | B59752C0120A070 |
| C1451 | 440 | 620 | 56 | ±25 | 130 | 2.1 | 100 | 1, 2, 3 | X | X | B59451C1130B070 |
| C753 | 440 | 620 | 120 | ±25 | 120 | 1.4 | 120 | 1, 2, 3 | X | X | B59753C0120A070 |
| C754 | 440 | 620 | 150 | ±25 | 120 | 1.4 | 120 | 1, 2, 3 | X | X | B59754C0120A070 |
| C773 | 440 | 620 | 500 | ±25 | 120 | 0.6 | 80 | 1, 2, 3 | — | — | B59773C0120A070 |
| C774 | 440 | 620 | 1100 | ±25 | 115 | 0.6 | 80 | 1, 2, 3 | — | — | B59774C0115A070 |
| C1412 | 480 | 680 | 120 | ±25 | 130 | 2.1 | 100 | 1, 2, 3 | X | X | B59412C1130B070 |
| C755 | 560 | 800 | 500 | ±25 | 115 | 1.4 | 120 | 1, 2, 3 | X | — | B59755C0115A070 |

Overcurrent protection and inrush current limiting

Leaded disks, 260 V up to 1000 V

Circuit diagrams

① Three phases circuit

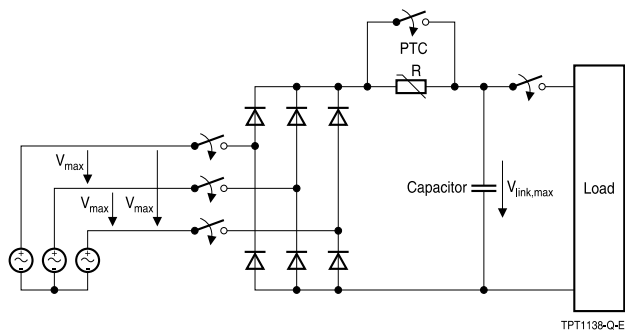

② Single phase circuit

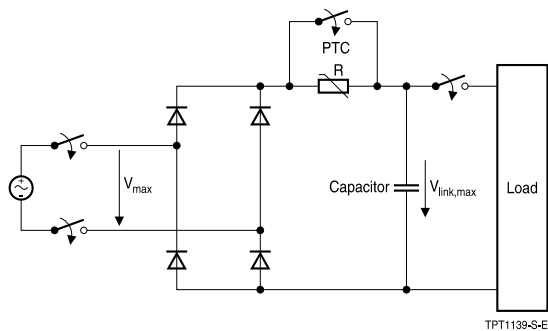

③ DC circuit

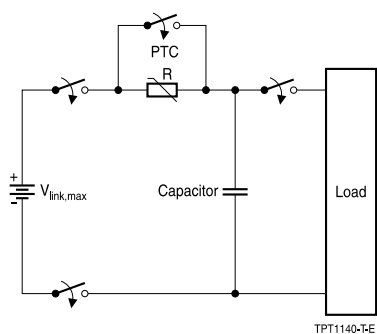

Overcurrent protection and inrush current limiting

Leaded disks, 260 V up to 1000 V

Calculation of the number of required PTC elements

Number of required PTC elements (connected in parallel) as function of capacitance and charging voltage of smoothing or DC link capacitor:

$$N \geq \frac{K \cdot C \cdot V^2}{2 \cdot C_{th} \cdot (T_{ref} - T_{A,max})}$$

| | |
|--------------------|--|
| K | K factor K = 1 for DC source K = 0.96 for 3-phase bridge rectifier K = 0.76 for single phase bridge rectifier |
| N | Number of required PTC thermistors connected in parallel |
| C | Capacitance of smoothing or DC link capacitor in F |
| V | Charging voltage of capacitor in V |
| C _{th} | Heat capacity in J/K |
| T _{ref} | Reference temperature of PTC in °C |
| T _{A,max} | Expected maximum ambient temperature in °C |

In case of large N values the resulting resistance of the parallel PTC network might be too low for effective limitation of the charging current. In this case a combination of series and parallel connected PTC thermistors can be used.



Overcurrent protection and inrush current limiting

Leaded disks, 260 V up to 1000 V

General technical data for overcurrent protection

| | | | | |
|-----------------------------|-------------------------|-----------------|----------|----|
| Switching cycles | | N | 100 | |
| Operating temperature range | (V = 0) | T _{op} | -40/+125 | °C |
| Operating temperature range | (V = V _{max}) | T _{op} | 0/+60 | °C |

Electrical specifications and ordering codes for overcurrent protection

| Type | I _R mA | I _S mA | I _{Smax} (V = V _{max}) A | I _r (typ.) (V = V _{max}) mA | R _R Ω | R _{min} Ω | Approvals   | | Ordering code |
|--|----------------------|----------------------|---|---|---------------------|-----------------------|--|---|-----------------|
| V_{max} = 440 V DC or V AC, V_R = 400 V DC or V AC, T_{ref} = 120 °C (typ.), ΔR_R = ±25 % | | | | | | | | | |
| B750 | 123 | 245 | 4.0 | 4 | 25 | 13 | X | X | B59750B0120A070 |
| B770 | 64 | 127 | 2.8 | 3.0 | 70 | 45 | X | X | B59770B0120A070 |
| C751 | 87 | 173 | 4.0 | 3.5 | 50 | 26 | X | X | B59751C0120A070 |
| C752 | 69 | 137 | 4.0 | 3.5 | 80 | 42 | X | X | B59752C0120A070 |
| C753 | 56 | 112 | 4.0 | 3.0 | 120 | 63 | X | X | B59753C0120A070 |
| C754 | 50 | 100 | 4.0 | 3.0 | 150 | 68 | X | X | B59754C0120A070 |
| C771 | 49 | 97 | 2.8 | 2.5 | 120 | 76 | X | X | B59771C0120A070 |
| C772 | 43 | 86 | 2.8 | 2.5 | 150 | 96 | X | X | B59772C0120A070 |
| V_{max} = 440 V DC or V AC, V_R = 400 V DC or V AC, T_{ref} = 130 °C (typ.), ΔR_R = ±25 % | | | | | | | | | |
| C1412 | 75 | 150 | 7.0 | 6.0 | 120 | 63 | – | – | B59412C1130B070 |
| C1451 | 100 | 200 | 12.0 | 7.0 | 56 | 29 | – | – | B59451C1130B070 |
| V_{max} = 550 V DC or V AC, V_R = 500 V DC or V AC, T_{ref} = 115 °C (typ.), ΔR_R = ±25 % | | | | | | | | | |
| C755 | 28 | 55 | 1.4 | 2.0 | 500 | 230 | X | X | B59755C0115A070 |
| C774 | 16 | 32 | 1.0 | 1.5 | 1100 | 700 | X | X | B59774C0115A070 |
| V_{max} = 550 V DC or V AC, V_R = 500 V DC or V AC, T_{ref} = 120 °C (typ.), ΔR_R = ±25 % | | | | | | | | | |
| C773 | 24 | 48 | 1.0 | 2.0 | 500 | 320 | X | X | B59773C0120A070 |
| V_{max} = 1000 V DC or V AC, V_R = 1000 V DC or V AC, T_{ref} = 110 °C (typ.), ΔR_R = ±33 % | | | | | | | | | |
| C758 | 8 | 17 | 0.5 | 3.0 | 7500 | 3380 | – | – | B59758C0110A070 |

Circuit diagram

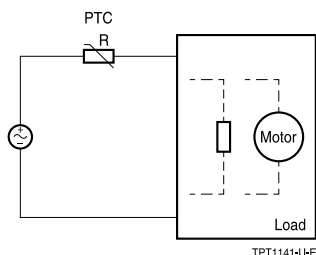

Overcurrent protection and inrush current limiting

Leaded disks, 260 V up to 1000 V

Reliability data for inrush current limiters and overcurrent protection

| Test | Standard | Test conditions | | $ \Delta R_{25}/R_{25} $ |
|--------------------------------|-------------|---|---|--------------------------|
| Electrical endurance, cycling | IEC 60738-1 | Overcurrent protection | Inrush current limiters | |
| | | Room temperature, $I_{s,max}$, V_{max} Number of cycles: 100 | Room temperature, $V_{link,max}$ applied energy $< C_{th} \cdot (T_{ref} - T_A)$ Number of cycles: 100 000 | < 25% |
| Electrical endurance, constant | IEC 60738-1 | Storage at V_{max} and $T_{op,max}$ (@ V_{max}) Test duration: 1000 h | | < 25% |
| Damp heat | IEC 60738-1 | Temperature of air: 40 °C Relative humidity of air: 93% Duration: 56 days Test according to IEC 60068-2-78 | | < 10% |
| Rapid change of temperature | IEC 60738-1 | $T_1 = T_{op,min}$ (0 V), $T_2 = T_{op,max}$ (0 V) Number of cycles: 5 Test duration: 30 min Test according to IEC 60068-2-14, test Na | | < 10% |
| Vibration | IEC 60738-1 | Frequency range: 10 to 55 Hz Displacement amplitude: 0.75 mm Test duration: 3 × 2 h Test according to IEC 60068-2-6, test Fc | | < 5% |
| Shock | IEC 60738-1 | Acceleration : 500 m/s ² Pulse duration: 11 ms; 6 x 3 pulses | | < 5% |
| Climatic sequence | IEC 60738-1 | Dry heat: $T = T_{op,max}$ (0 V) Test duration: 16 h Damp heat first cycle Cold: $T = T_{op,min}$ (0 V) Test duration: 2 h Damp heat 5 cycles Tests performed according to IEC 60068-2-30 | | < 10% |

Overcurrent protection and inrush current limiting

Leaded disks, 260 V up to 1000 V

Characteristics (typical)

PTC resistance R_{PTC} versus
PTC temperature T_{PTC}
(measured at low signal voltage)

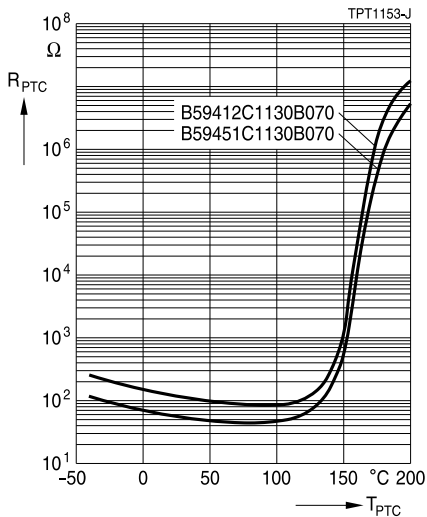

Residual current in high-ohmic state I_{res} as
function of applied voltage V_{PTC} ; typical
(measured at 25 °C in still air)

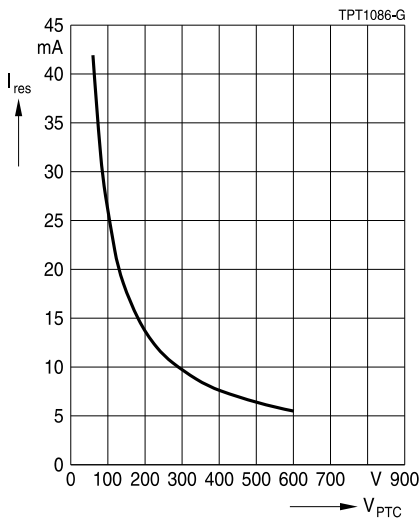

Minimum resistance of PTC thermistors
versus applied voltage (pulsed)

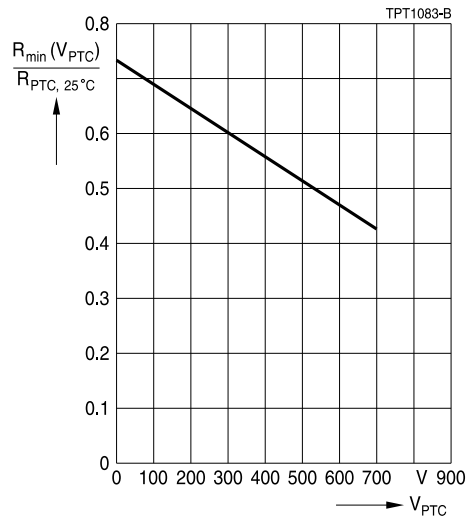

Switching time t_s versus switching current I_s
(measured at 25 °C in still air)

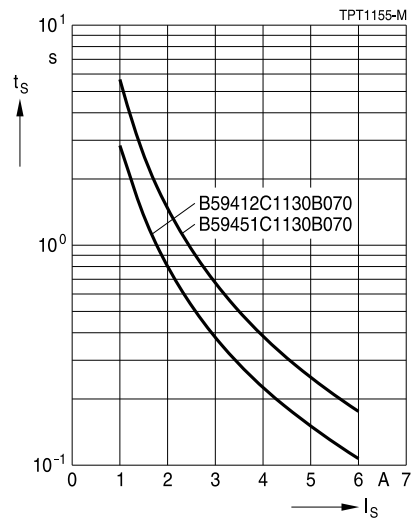

Overcurrent protection and inrush current limiting

Leaded disks, 260 V up to 1000 V

Characteristics (typical)

PTC current I_{PTC} versus PTC voltage V_{PTC}
(measured at 25 °C in still air)

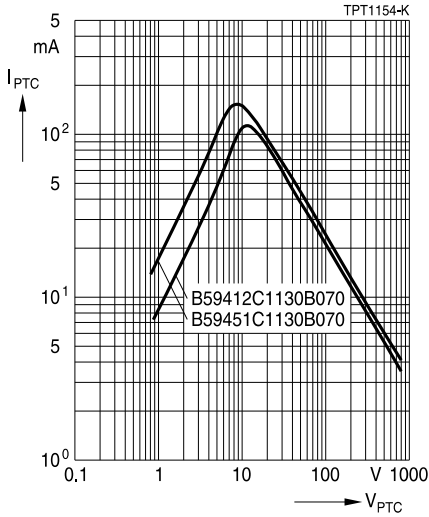

Rated current I_R versus ambient temperature T_A
(measured in still air)

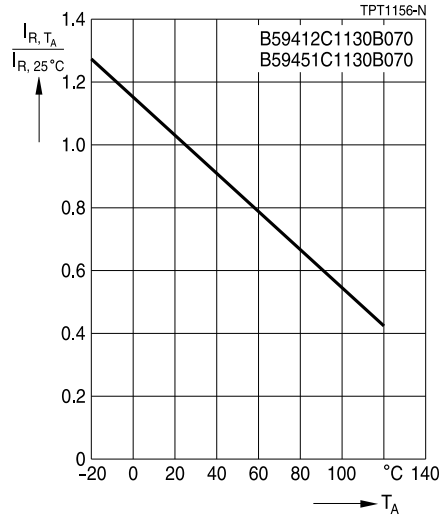

Overcurrent protection and inrush current limiting

Leaded disks, 260 V up to 1000 V

Characteristics (typical)

PTC resistance R_{PTC} versus
PTC temperature T_{PTC}
(measured at low signal voltage)

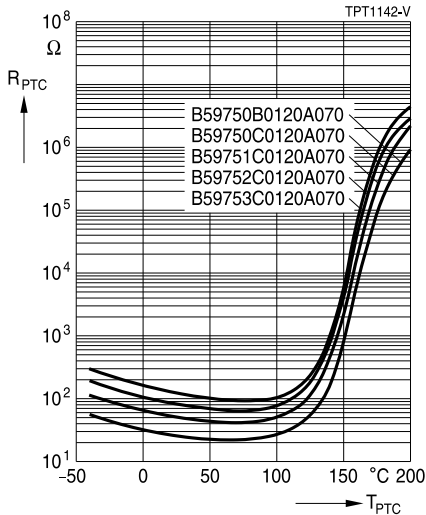

Residual current in high-ohmic state I_{res} as
function of applied voltage V_{PTC} ; typical
(measured at 25 °C in still air)

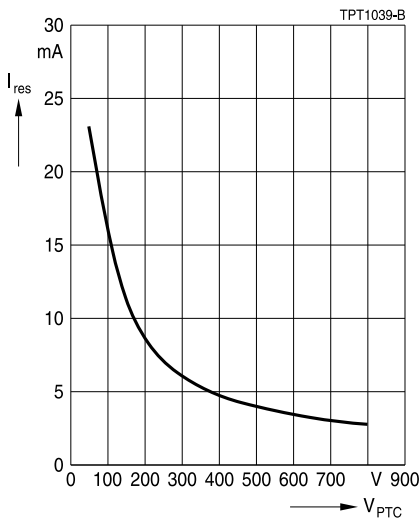

Minimum resistance of PTC thermistors
versus applied voltage (pulsed)

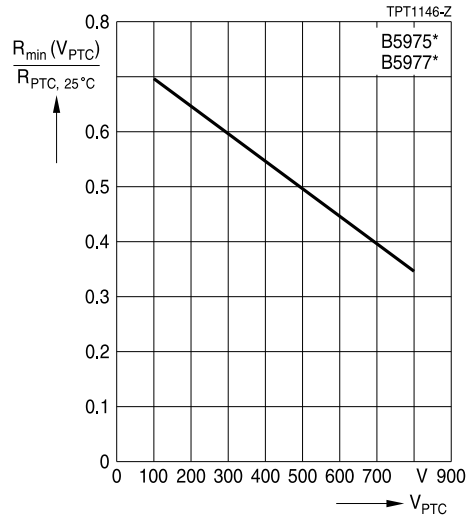

Switching time t_s versus switching current I_s
(measured at 25 °C in still air)

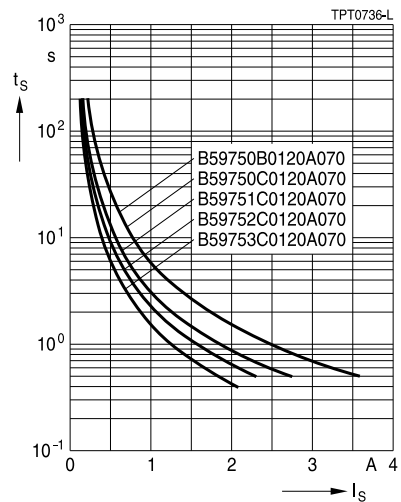

Overcurrent protection and inrush current limiting

Leaded disks, 260 V up to 1000 V

Characteristics (typical)

PTC current I_{PTC} versus PTC voltage V_{PTC}
(measured at 25 °C in still air)

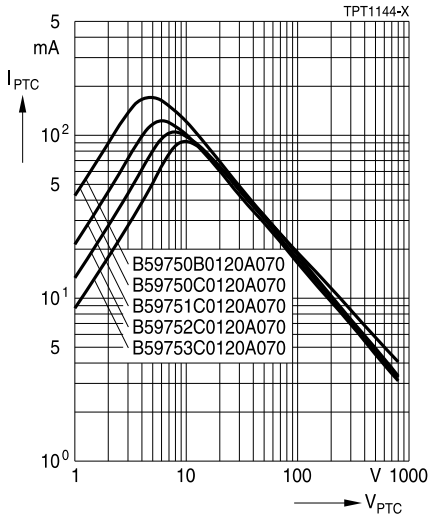

Rated current I_R versus ambient temperature T_A
(measured in still air)

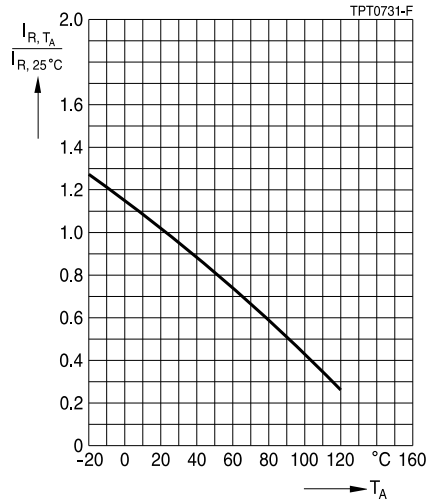

Overcurrent protection and inrush current limiting

Leaded disks, 260 V up to 1000 V

Characteristics (typical)

PTC resistance R_{PTC} versus
PTC temperature T_{PTC}
(measured at low signal voltage)

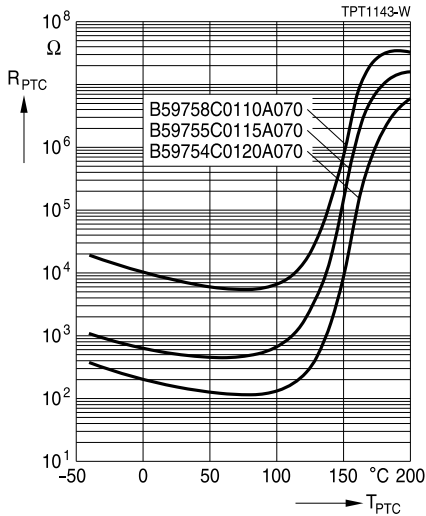

Residual current in high-ohmic state I_{res} as
function of applied voltage V_{PTC} , typical
(measured at 25 $^{\circ}\text{C}$ in still air)

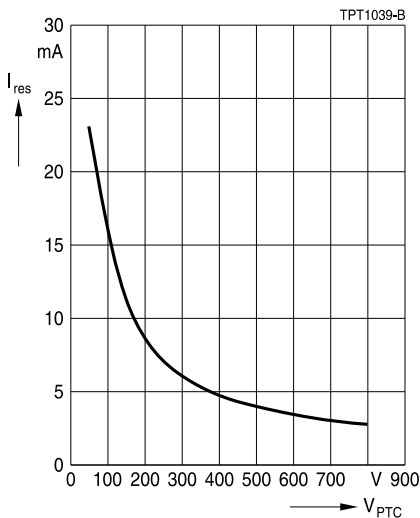

Minimum resistance of PTC thermistors
versus applied voltage (pulsed)

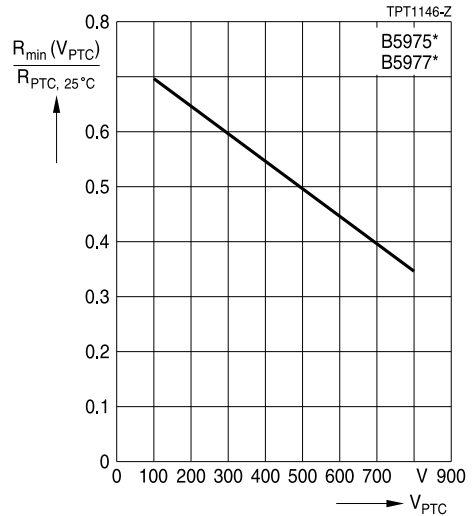

Switching time t_s versus switching current I_s
(measured at 25 $^{\circ}\text{C}$ in still air)

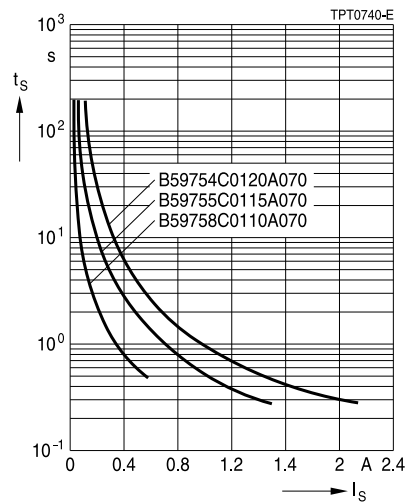

Overcurrent protection and inrush current limiting

Leaded disks, 260 V up to 1000 V

Characteristics (typical)

PTC current I_{PTC} versus PTC voltage V_{PTC}
(measured at 25 °C in still air)

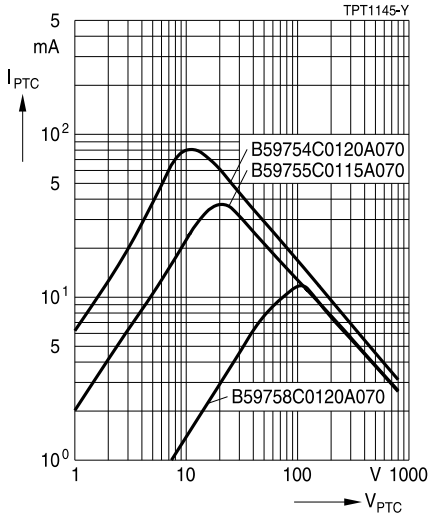

Rated current I_R versus ambient temperature T_A
(measured in still air)

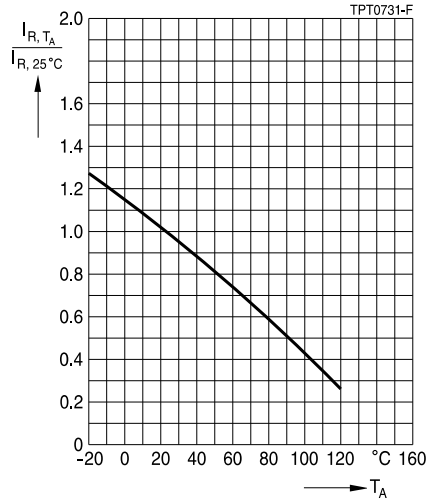

Overcurrent protection and inrush current limiting

Leaded disks, 260 V up to 1000 V

Characteristics (typical)

PTC resistance R_{PTC} versus
PTC temperature T_{PTC}
(measured at low signal voltage)

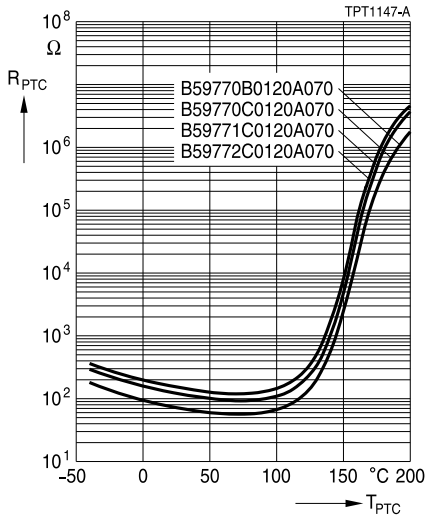

Residual current in high-ohmic state I_{res} as
function of applied voltage V_{PTC} ; typical
(measured at 25 °C in still air)

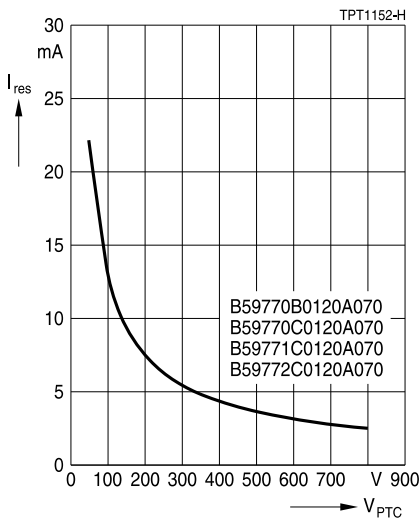

Minimum resistance of PTC thermistors
versus applied voltage (pulsed)

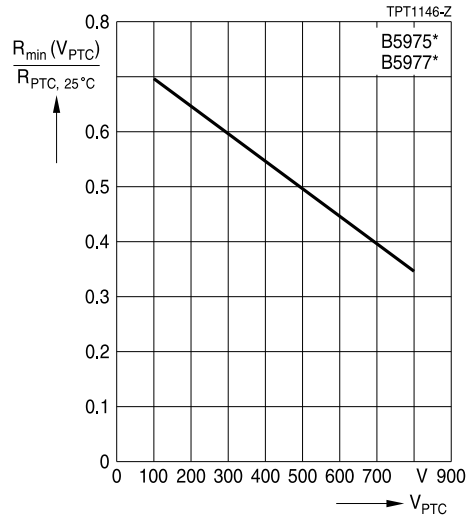

Switching time t_s versus switching current I_s
(measured at 25 °C in still air)

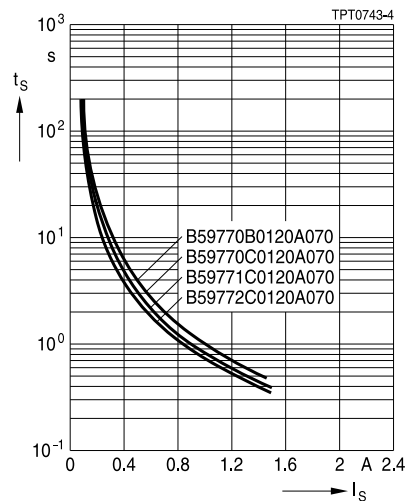

Overcurrent protection and inrush current limiting

Leaded disks, 260 V up to 1000 V

Characteristics (typical)

PTC current I_{PTC} versus PTC voltage V_{PTC}
(measured at 25 °C in still air)

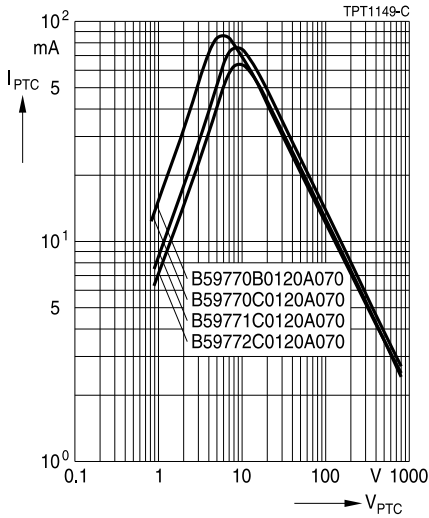

Rated current I_R versus ambient temperature T_A
(measured in still air)

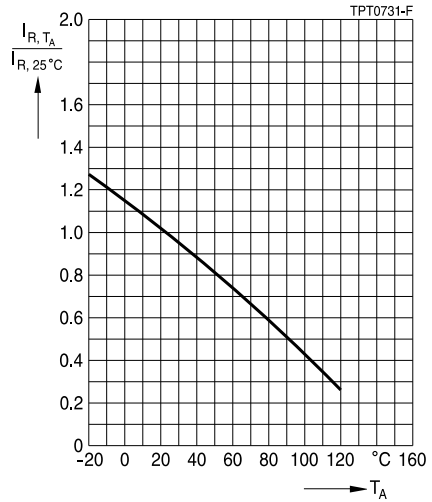

Overcurrent protection and inrush current limiting

Leaded disks, 260 V up to 1000 V

Characteristics (typical)

PTC resistance R_{PTC} versus
PTC temperature T_{PTC}
(measured at low signal voltage)

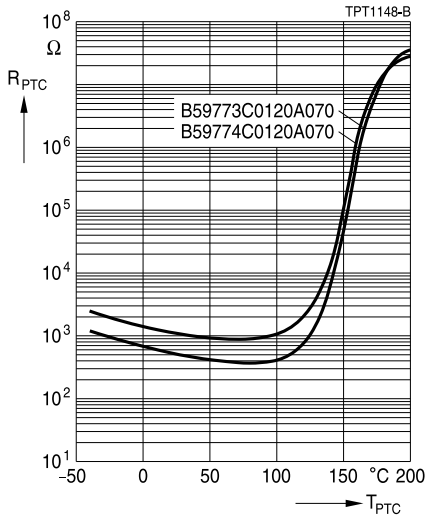

Residual current in high-ohmic state I_{res} as
function of applied voltage V_{PTC} ; typical
(measured at 25 °C in still air)

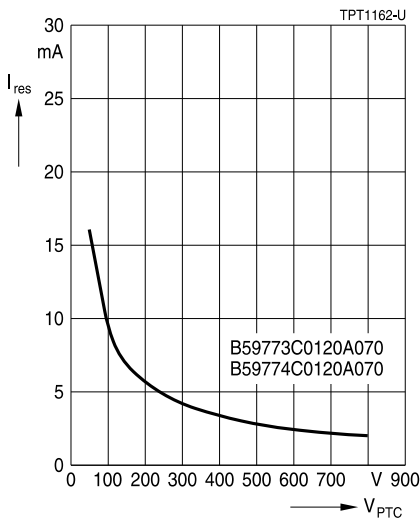

Minimum resistance of PTC thermistors
versus applied voltage (pulsed)

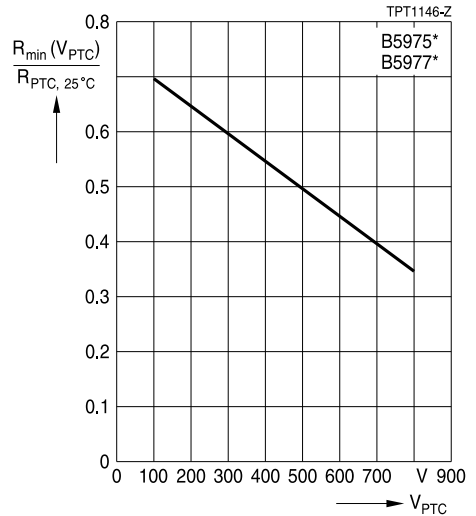

Switching time t_s versus switching current I_s
(measured at 25 °C in still air)

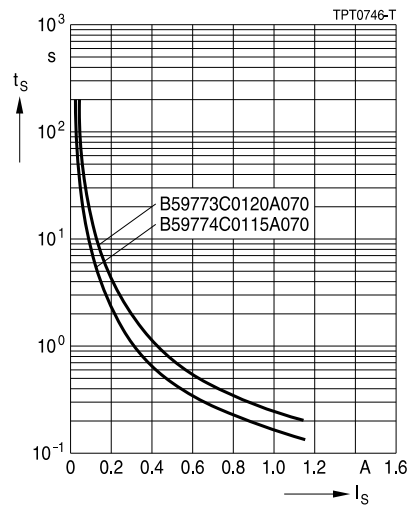

Overcurrent protection and inrush current limiting

Leaded disks, 260 V up to 1000 V

Characteristics (typical)

PTC current I_{PTC} versus PTC voltage V_{PTC}
(measured at 25 °C in still air)

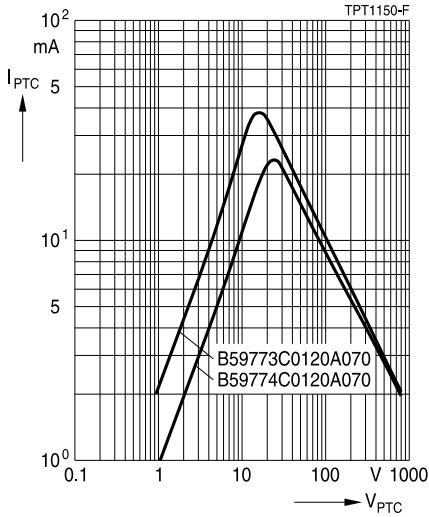

Rated current I_R versus ambient temperature T_A
(measured in still air)

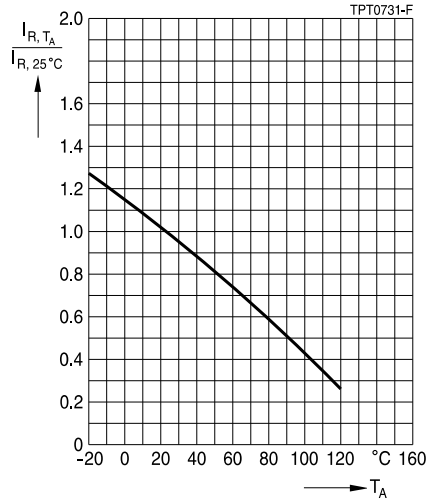

Overcurrent protection and inrush current limiting

Leaded disks, 260 V up to 1000 V

Cautions and warnings

General

- EPCOS thermistors are designed for specific applications and should not be used for purposes not identified in our specifications, application notes and data books unless otherwise agreed with EPCOS during the design-in-phase.
- Ensure suitability of thermistor through reliability testing during the design-in phase. The thermistors should be evaluated taking into consideration worst-case conditions.

Storage

- Store thermistors only in original packaging. Do not open the package prior to processing.
- Storage conditions in original packaging: storage temperature $-25\text{ }^{\circ}\text{C} \dots +45\text{ }^{\circ}\text{C}$, relative humidity $\leq 75\%$ annual mean, maximum 95%, dew precipitation is inadmissible.
- Avoid contamination of thermistors surface during storage, handling and processing.
- Avoid storage of thermistor in harmful environment with effect on function on long-term operation (examples given under operation precautions).
- Use thermistor within the following period after delivery:
 - Through-hole devices (housed and leaded PTCs): 24 months
 - Motor protection sensors, glass-encapsulated sensors and probe assemblies: 24 months
 - Telecom pair and quattro protectors (TPP, TQP): 24 months
 - Leadless PTC thermistors for pressure contacting: 12 months
 - Leadless PTC thermistors for soldering: 6 months
 - SMDs in EIA sizes 3225 and 4032, and for PTCs with metal tags: 24 months
 - SMDs in EIA sizes 1210 and smaller: 12 months

Handling

- PTCs must not be dropped. Chip-offs must not be caused during handling of PTCs.
- The ceramic and metallization of the components must not be touched with bare hands. Gloves are recommended.
- Avoid contamination of thermistor surface during handling.

Soldering (where applicable)

- Use rosin-type flux or non-activated flux.
- Insufficient preheating may cause ceramic cracks.
- Rapid cooling by dipping in solvent is not recommended.
- Complete removal of flux is recommended.
- Standard PTC heaters are not suitable for soldering.

Overcurrent protection and inrush current limiting

Leaded disks, 260 V up to 1000 V

Mounting

- Electrode must not be scratched before/during/after the mounting process.
- Contacts and housing used for assembly with thermistor have to be clean before mounting. Especially grease or oil must be removed.
- When PTC thermistors are encapsulated with sealing material, the precautions given in chapter "Mounting instructions", "Sealing and potting" must be observed.
- When the thermistor is mounted, there must not be any foreign body between the electrode of the thermistor and the clamping contact.
- The minimum force and pressure of the clamping contacts pressing against the PTC must be 10 N and 50 kPa, respectively. In case the assembly is exposed to mechanical shock and/ or vibration this force should be higher in order to avoid movement of the PTC during operation.
- During operation, the thermistor's surface temperature can be very high. Ensure that adjacent components are placed at a sufficient distance from the thermistor to allow for proper cooling at the thermistors.
- Ensure that adjacent materials are designed for operation at temperatures comparable to the surface temperature of thermistor. Be sure that surrounding parts and materials can withstand this temperature.
- Avoid contamination of thermistor surface during processing.

Operation

- Use thermistors only within the specified temperature operating range.
- Use thermistors only within the specified voltage and current ranges.
- Environmental conditions must not harm the thermistors. Use thermistors only in normal atmospheric conditions. Avoid use in deoxidizing gases (chlorine gas, hydrogen sulfide gas, ammonia gas, sulfuric acid gas etc), corrosive agents, humid or salty conditions. Contact with any liquids and solvents should be prevented.
- Be sure to provide an appropriate fail-safe function to prevent secondary product damage caused by abnormal function (e.g. use VDR for limitation of overvoltage condition).

This listing does not claim to be complete, but merely reflects the experience of EPCOS AG.

Display of ordering codes for EPCOS products

The ordering code for one and the same EPCOS product can be represented differently in data sheets, data books, other publications, on the EPCOS website, or in order-related documents such as shipping notes, order confirmations and product labels. **The varying representations of the ordering codes are due to different processes employed and do not affect the specifications of the respective products.** Detailed information can be found on the Internet under www.epcos.com/orderingcodes

Overcurrent protection and inrush current limiting

Leaded disks, 260 V up to 1000 V

Symbols and terms

| Symbol | Term |
|-----------------|---|
| A | Area |
| C | Capacitance |
| C_{th} | Heat capacity |
| f | Frequency |
| I | Current |
| I_{max} | Maximum current |
| I_R | Rated current |
| I_{res} | Residual current |
| I_{PTC} | PTC current |
| I_r | Residual current |
| $I_{r,oil}$ | Residual current in oil (for level sensors) |
| $I_{r,air}$ | Residual current in air (for level sensors) |
| I_{RMS} | Root-mean-square value of current |
| I_S | Switching current |
| I_{Smax} | Maximum switching current |
| LCT | Lower category temperature |
| N | Number (integer) |
| N_c | Operating cycles at V_{max} , charging of capacitor |
| N_f | Switching cycles at V_{max} , failure mode |
| P | Power |
| P_{25} | Maximum power at 25 °C |
| P_{el} | Electrical power |
| P_{diss} | Dissipation power |
| R_G | Generator internal resistance |
| R_{min} | Minimum resistance |
| R_R | Rated resistance @ rated temperature T_R |
| ΔR_R | Tolerance of R_R |
| R_P | Parallel resistance |
| R_{PTC} | PTC resistance |
| R_{ref} | Reference resistance |
| R_S | Series resistance |
| R_{25} | Resistance at 25 °C |
| $R_{25,match}$ | Resistance matching per reel/ packing unit at 25 °C |
| ΔR_{25} | Tolerance of R_{25} |

Overcurrent protection and inrush current limiting

Leaded disks, 260 V up to 1000 V

| | |
|---|--|
| T | Temperature |
| t | Time |
| T _A | Ambient temperature |
| t _a | Thermal threshold time |
| T _C | Ferroelectric Curie temperature |
| t _E | Settling time (for level sensors) |
| T _R | Rated temperature @ 25 °C or otherwise specified in the data sheet |
| T _{sense} | Sensing temperature |
| T _{op} | Operating temperature |
| T _{PTC} | PTC temperature |
| t _R | Response time |
| T _{ref} | Reference temperature |
| T _{Rmin} | Temperature at minimum resistance |
| t _S | Switching time |
| T _{surf} | Surface temperature |
| UCT | Upper category temperature |
| V or V _{el} | Voltage (with subscript only for distinction from volume) |
| V _{c(max)} | Maximum DC charge voltage of the surge generator |
| V _{F,max} | Maximum voltage applied at fault conditions in protection mode |
| V _{RMS} | Root-mean-square value of voltage |
| V _{BD} | Breakdown voltage |
| V _{ins} | Insulation test voltage |
| V _{link,max} | Maximum link voltage |
| V _{max} | Maximum operating voltage |
| V _{max,dyn} | Maximum dynamic (short-time) operating voltage |
| V _{meas} | Measuring voltage |
| V _{meas,max} | Maximum measuring voltage |
| V _R | Rated voltage |
| V _{PTC} | Voltage drop across a PTC thermistor |
| α | Temperature coefficient |
| Δ | Tolerance, change |
| δ _{th} | Dissipation factor |
| τ _{th} | Thermal cooling time constant |
| λ | Failure rate |
|  | Lead spacing (in mm) |

Important notes

The following applies to all products named in this publication:

1. Some parts of this publication contain **statements about the suitability of our products for certain areas of application**. These statements are based on our knowledge of typical requirements that are often placed on our products in the areas of application concerned. We nevertheless expressly point out **that such statements cannot be regarded as binding statements about the suitability of our products for a particular customer application**. As a rule, EPCOS is either unfamiliar with individual customer applications or less familiar with them than the customers themselves. For these reasons, it is always ultimately incumbent on the customer to check and decide whether an EPCOS product with the properties described in the product specification is suitable for use in a particular customer application.
2. We also point out that **in individual cases, a malfunction of electronic components or failure before the end of their usual service life cannot be completely ruled out in the current state of the art, even if they are operated as specified**. In customer applications requiring a very high level of operational safety and especially in customer applications in which the malfunction or failure of an electronic component could endanger human life or health (e.g. in accident prevention or lifesaving systems), it must therefore be ensured by means of suitable design of the customer application or other action taken by the customer (e.g. installation of protective circuitry or redundancy) that no injury or damage is sustained by third parties in the event of malfunction or failure of an electronic component.
3. **The warnings, cautions and product-specific notes must be observed.**
4. In order to satisfy certain technical requirements, **some of the products described in this publication may contain substances subject to restrictions in certain jurisdictions (e.g. because they are classed as hazardous)**. Useful information on this will be found in our Material Data Sheets on the Internet (www.epcos.com/material). Should you have any more detailed questions, please contact our sales offices.
5. We constantly strive to improve our products. Consequently, **the products described in this publication may change from time to time**. The same is true of the corresponding product specifications. Please check therefore to what extent product descriptions and specifications contained in this publication are still applicable before or when you place an order. We also **reserve the right to discontinue production and delivery of products**. Consequently, we cannot guarantee that all products named in this publication will always be available. The aforementioned does not apply in the case of individual agreements deviating from the foregoing for customer-specific products.
6. Unless otherwise agreed in individual contracts, **all orders are subject to the current version of the "General Terms of Delivery for Products and Services in the Electrical Industry" published by the German Electrical and Electronics Industry Association (ZVEI)**.

Important notes

7. The trade names EPCOS, CeraCharge, CeraDiode, CeraLink, CeraPad, CeraPlas, CSMP, CTVS, DeltaCap, DigiSiMic, ExoCore, FilterCap, FormFit, LeaXield, MiniBlue, MiniCell, MKD, MKK, MotorCap, PCC, PhaseCap, PhaseCube, PhaseMod, PhiCap, PowerHap, PQSine, PQvar, SIFERRIT, SIFI, SIKOREL, SilverCap, SIMDAD, SiMic, SIMID, SineFormer, SIOV, ThermoFuse, WindCap are **trademarks registered or pending** in Europe and in other countries. Further information will be found on the Internet at www.epcos.com/trademarks.

X-ON Electronics

Largest Supplier of Electrical and Electronic Components

Click to view similar products for [PTC Thermistors](#) category:

Click to view products by [EPCOS](#) manufacturer:

Other Similar products are found below :

[PTCAUX7-36-5C](#) [PTCCL09H251FBE](#) [PTCTL3MR100GTE](#) [B59050D1100B40](#) [B59406B0060A040](#) [B59970C160A70](#) [PTCCL05H630HTE](#)
[B59346A1502P020](#) [B59980C0160A070](#) [PTCTT95R100GTE](#) [PTCCL07H700HBE](#) [B59841C0135A070](#) [PTCCL09H541DBE](#)
[B59544A0120A020](#) [NB-PTCO-050](#) [B59535T1120A262](#) [TFPT0603L3900FV](#) [LT7339002A2K0JTE](#) [NB-PTCO-142](#) [TFPT0805L1800FV](#)
[PTCEL13R501RBE](#) [B59725T1120A062](#) [PTC305C2](#) [B59011E0160A040](#) [B59891C0135A070](#) [B59052D1100A40](#) [YQR100R060](#)
[YQS5751PTO](#) [YQS5856PTF](#) [YQS5930PTO](#) [YS5675](#) [YS5918PTO](#) [YS5677](#) [YQS5898PTO](#) [YQS5868PTF](#) [YQD100N1000](#) [B59001Z999A99](#)
[B59002Z999A99](#) [B59010D1135B40](#) [B59219J130A20](#) [B59606A110A62](#) [B59830C120A70](#) [B59005Z999A99](#) [B59641A0135A062](#)
[B59874C120A70](#) [B59960C160A70](#) [PTGL10ARR27M1B51A0](#) [YQD120N0025](#) [PTGL12AS4R7K6B51B0](#) [PTGL12AR100M6C01B0](#)