

THIS DRAWING IS UNPUBLISHED
RELEASED FOR PUBLICATION 2015
© COPYRIGHT 2011 BY TE CONNECTIVITY ALL RIGHTS RESERVED.

P	LTR	DESCRIPTION	DATE	DWN	APVD
	NC	NEW RELEASE PER E.O. P20692	14JUL2011	SZ	RDR
	A	REVISED PER ECO-15-000132	05JAN2015	JA	DM

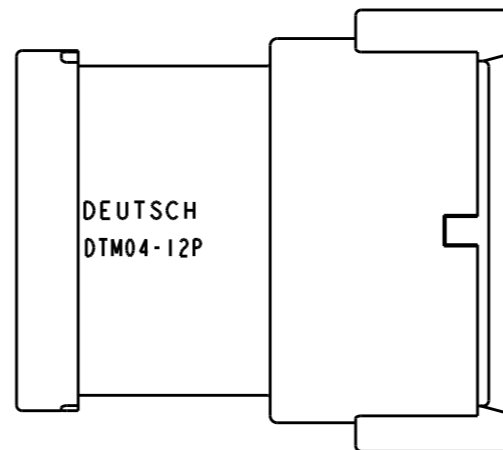

TE INTERNAL PN	DEUTSCH PN
DTM04-12PA-E005	DTM04-12PA-E005
DTM04-12PB-E005	DTM04-12PB-E005
DTM04-12PC-E005	DTM04-12PC-E005
DTM04-12PD-E005	DTM04-12PD-E005

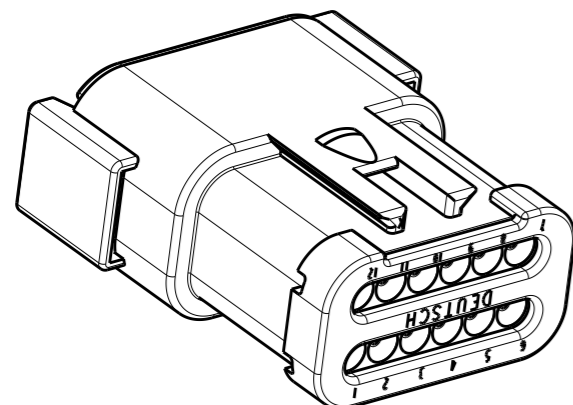
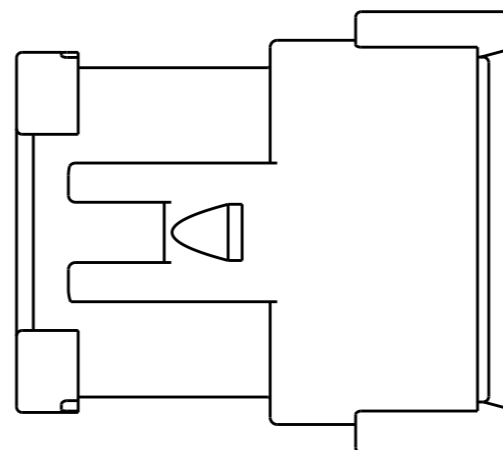
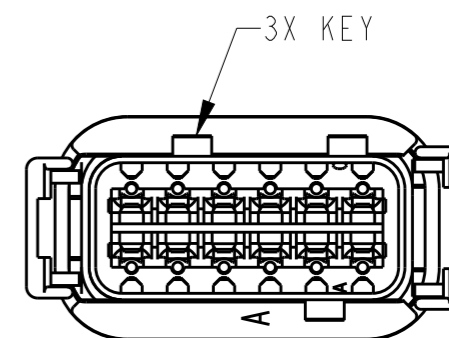
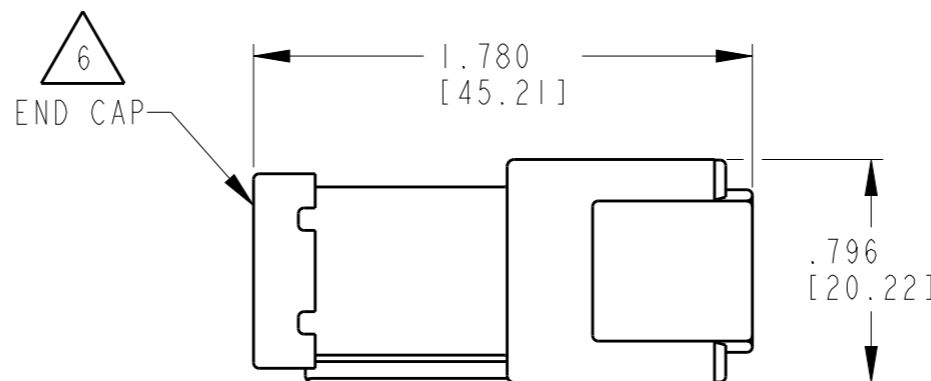
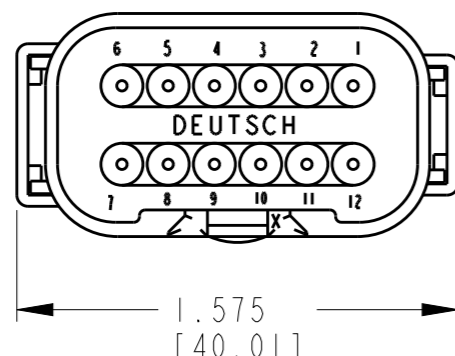

CONTACT SIZE	MIN. INSUL. O.D.	MAX. INSUL. O.D.	WIRE RANGE [mm ²] REF ONLY
20	.053 [1.35]	.120 [3.05]	16-20 AWG [1.0-0.5]

- 6 PART MODIFICATION.
- 5. SEE SHEET 2 FOR OTHER KEY ARRANGEMENTS.
- 4 MATERIAL - HOUSING/END CAP: NYLON 6/6 15% GF, COLOR: BLACK; GROMMET: SILICONE.
- 3. THIS RECEPTACLE MATES WITH DTM06-12SX-XXXX PLUG. (X = A,B,C,D KEYS; XXXX = ALL MODIFICATIONS)
- 2 FOR CONTACT AND WIRE PERFORMANCE AND APPLICATION CHARACTERISTICS SEE ENVELOPE DRAWING 0425-015-0000.
- 1. SECONDARY WEDGE LOCK SOLD SEPARATELY: WM-12P.

NOTES: UNLESS OTHERWISE SPECIFIED

THIS DRAWING IS A CONTROLLED DOCUMENT.		DWN 01 JUN 2011 S. ZERMENO			
DIMENSIONS: INCHES [mm]		CHK 06 JUN 2011 BOB MILLIGAN			
TOLERANCES UNLESS OTHERWISE SPECIFIED:		APVD 12 JUL 2011 STEVE BEARD		NAME RECEPTACLE HOUSING 12 PIN SIZE 20 CONTACTS DTM SERIES	
0 PLC ± 1 PLC ± 2 PLC ± 3 PLC ±.025 [0.64] 4 PLC ± ANGLES ±0°30'0"		PRODUCT SPEC 0425-015-0000		SIZE A3	
MATERIAL 4		FINISH N/A		CAGE CODE 4AFU8	
		APPLICATION SPEC 0425-015-0000		DRAWING NO DTM04-12PX-E005	
		WEIGHT 18.92g		RESTRICTED TO -	
		Customer Drawing		SCALE 3:2 SHEET 1 OF 2 REV A	

THIS DRAWING IS UNPUBLISHED
 RELEASED FOR PUBLICATION 2015
 © COPYRIGHT 2011 BY TE CONNECTIVITY ALL RIGHTS RESERVED.

LOC	DIST	REVISIONS			
P	LTR	DESCRIPTION	DATE	DWN	APVD
		SEE SHEET 1	-	-	-

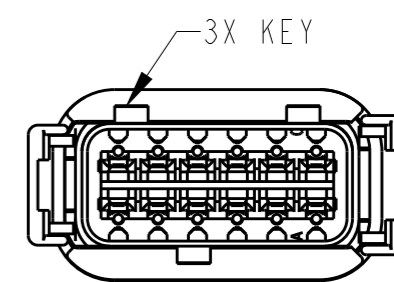
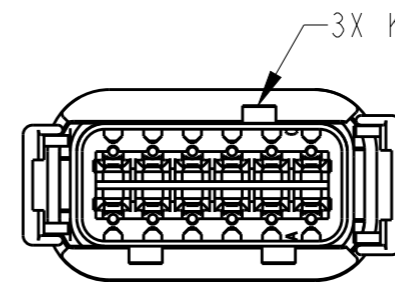
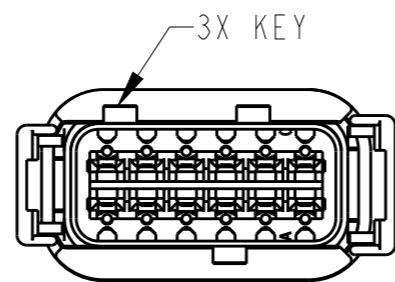
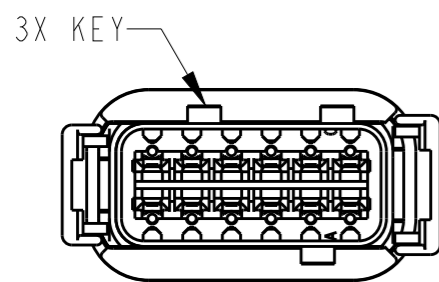
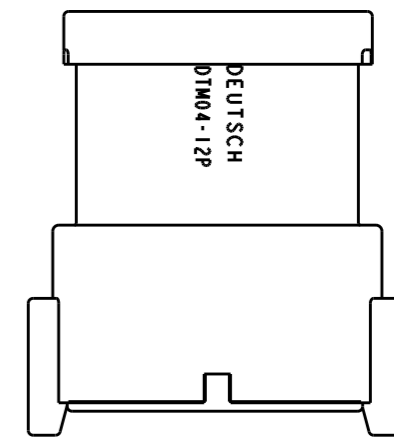
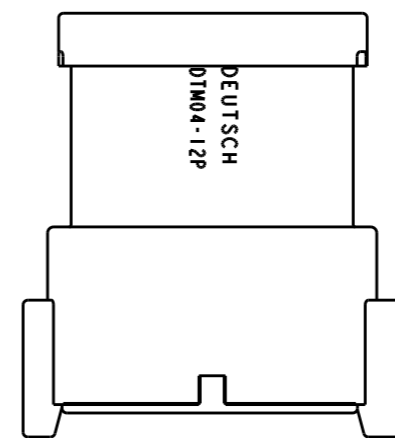
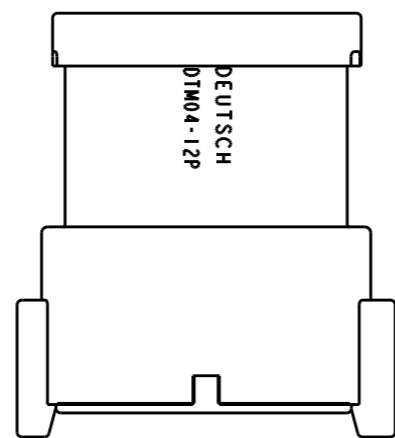
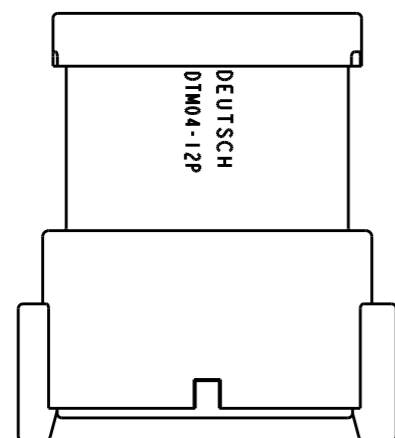

**DTM04-12PA-E005
KEY -A-**

**DTM04-12PB-E005
KEY -B-**

**DTM04-12PC-E005
KEY -C-**

**DTM04-12PD-E005
KEY -D-**

THIS DRAWING IS A CONTROLLED DOCUMENT.		DWN S. ZERMENO 01 JUN 2011			
DIMENSIONS: INCHES [mm]		CHK BOB MILLIGAN 06 JUN 2011			
TOLERANCES UNLESS OTHERWISE SPECIFIED:		APVD STEVE BEARD 12 JUL 2011		NAME RECEPTACLE HOUSING 12 PIN SIZE 20 CONTACTS DTM SERIES	
0 PLC ± 1 PLC ± 2 PLC ± 3 PLC ±.025 [0.64] 4 PLC ± ANGLES ±0°30'0"		PRODUCT SPEC 0425-015-0000		SIZE A3	
MATERIAL 4		APPLICATION SPEC 0425-015-0000		CAGE CODE 4AFU8	
FINISH N/A		WEIGHT 18.92g		DRAWING NO. DTM04-12PX-E005	
		Customer Drawing		RESTRICTED TO -	
		SCALE 3:2		SHEET 2 OF 2	
				REV A	

X-ON Electronics

Largest Supplier of Electrical and Electronic Components

Click to view similar products for [Automotive Connectors](#) category:

Click to view products by [TE Connectivity](#) manufacturer:

Other Similar products are found below :

[003-018-000](#) [600858](#) [60403001](#) [60993906-B](#) [60993913-B](#) [629515004020001](#) [M902-2131](#) [M902-2161](#) [M902-2344](#) [72.330.1035.1](#)
[73.353.4028.0](#) [F118010](#) [F119300-B](#) [F132210](#) [F132210-B](#) [F166900](#) [F180100](#) [F258300](#) [F258300-B](#) [F294300-B](#) [F339100](#) [F339700](#) [F358300-](#)
[B](#) [F374110](#) [F407400](#) [F412210](#) [F427600](#) [F444110](#) [F487000](#) [F495100-B](#) [F500900-B](#) [F509500B-B](#) [770444-1](#) [776880-1](#) [827153-1](#) [881735-1](#)
[8N1515-32-24P](#) [9-1326729-8](#) [925467-1](#) [925474-1](#) [928905-1](#) [936398-2](#) [964562-1](#) [964562-4](#) [964731-2](#) [965051-1](#) [968782-1](#) [GT17SA-8DS-](#)
[HU](#) [GT17VS-10DP-5.2CF](#) [98315-0001](#)