

Uninterruptible Power Supply (UPS)

S8BA

Compact DC-DC UPS mounts to DIN rail, best suited to prevent sudden power loss in industrial-purpose computers (IPC)/controllers due to voltage drop or power failure

- System reliability greatly improved because 24VDC power supply is backed up for a certain period of time in the event of voltage drop or power failure.
- Compactness, weight reduction, and long battery life realized thanks to the adoption of a lithium-ion battery.
- Push-in terminal block adopted for the power input and output I/F.
- Shutdown in conjunction with the industrial purpose computer (IPC) or controller realized by the USB/RS-232C/I/O port installed in the UPS.



⚠ Refer to *Safety Precautions* on page 12.

Model Number Structure

Model Number Legend * Use the following format to place an order.

S8BA- □ □ □ □ □ □ □ □ □ □
Series name 1 2 3 4 5

1. Input voltage specification

24D: 24 VDC

2. Output voltage

24D: 24 VDC

3. Capacity

120: 120 W

240: 240 W

360: 360 W

480: 480 W

4. Battery type

L: Lithium-ion battery

5. Terminal block shape

F: Push-in terminal block

Ordering Information

Note: For details on normal stock models, contact your nearest OMRON representative.

Main body

Uninterruptible Power Supply (UPS)

Input voltage	Output voltage	Output current/capacity	Model number
24 VDC	24 VDC	5 A/120 W	S8BA-24D24D120LF
		10 A/240 W	S8BA-24D24D240LF
		15 A/360 W	S8BA-24D24D360LF
		20 A/480 W *	S8BA-24D24D480LF

* 16.7 A/400 W for use as a UL compliant device.

Communication cable

Specifications	Type	Length	Model number
For RS-232C port	RJ45/Dsub9Pin	2 m	S8BW-C01
For CONTACT port	RJ45/Discrete wire		S8BW-C02

Ratings, Characteristics, and Functions

Item	Capacity	120 W	240 W	360 W	480 W *4	
DC input	Rated input voltage		24 VDC			
	Input voltage range	(When standard voltage sensitivity is set)	24 VDC±10%			
		(When low voltage sensitivity is set)	24 VDC±12.5%			
		(When high voltage sensitivity is set)	24 VDC±5%			
	Input maximum current	(for rated input voltage)	5.9 A	11.7 A	17.5 A	23.3 A *5
	Input terminal		Push-in terminal block			
	Input protection		Fuse			
	Input protection capacity		10 A	15 A	30 A	
Inrush current		12 A max., 0.1 ms max.	14 A max., 0.1 ms max.	16 A max., 0.1 ms max.		
DC output	Rated current	(for rated output voltage)	5 A	10 A	15 A	20 A *6
	Switching time		Uninterrupted			
	Output voltage	Normal operation	Output of input voltage as-is			
		Backup operation	24 V±5%			
	Output terminal		Push-in terminal block			
	Overload protection		Alarm display at a load level of 110% or over (normal operation)			
Alarm display at a load level of 110% or over and output voltage drop (backup operation)						
Alarm display cancellation at a load equal to or below the rated capacity (normal operation, backup operation)						
Battery	Type		Lithium-ion battery			
	Rated voltage		14.4 VDC			
	Rated capacity		1600 mAh × 1 parallel	1600 mAh × 2 parallel	1600 mAh × 3 parallel	1600 mAh × 4 parallel
	Expected battery life *1		2.5 years (50°C), 5 years (40°C), 10 years (25°C)			
	Replacement by user		Yes (Hot swapping)			
	Auto battery check function		Yes			
	Battery life counter function		Yes			
	Charging time		4 hours *7			
Backup time (25°C, initial characteristics)		6 min. (120 W)	6 min. (240 W)	6 min. (360 W)	6 min. (480 W)	
Environment	Operating ambient temperature/humidity		0 to 55°/10 to 90° (with no condensation)			
	Storage ambient temperature/humidity		-20° to 55°/10 to 90% (with no condensation)			
	Vibration resistance		JIS C 60068-2-6 compliant. 5 to 8.4 Hz amplitude: 3.5 mm, 8.4 to 150 Hz acceleration rate: 9.8 m/s ² X, Y, and Z directions for 100 minutes (Time coefficient: 10 minutes × coefficient factor 10 = total time 100 min.)			
	Shock resistance		JIS C 60068-2-27 compliant. 147 m/s ² , 3 times in X, Y, and Z directions.			
Enclosure	Dimensions (W × D × H mm)		94 × 100 × 100	148 × 100 × 100	270 × 100 × 100	
	Weight of unit		Approx. 0.8 kg	Approx. 1.3 kg	Approx. 2.0 kg	Approx. 2.3 kg
	Cooling method		Natural cooling			
Insulation and withstand voltage	Withstand voltage		1,000 V 50/60 Hz AC between the DC external terminals and the GR terminal for 1 minute at a leakage current of 10 mA max.			
	Insulation resistance		20 MΩ min. between the DC external terminals and the GR terminal (at 500 VDC)			
Safety standard compliance		UL508/CE/C22.2 No.107.1-01				
Internal power consumption (normal *2 / maximum *3)		7 W/22 W	11 W/41 W	14 W/60 W	18 W/80 W	
Serial communication	RS232C (Interface terminal)		Yes (RJ45)			
	USB (interface terminal)		Yes (B connector)			
I/O signal		Yes (RJ45)				
Accessory functions		Beeper setting; Auto restart setting; Auto test setting; Auto restart mode setting; Input sensitivity setting; Remote ON/OFF signal logic setting; Cold start setting; Battery life counter setting; Power switch function setting; Maximum backup time setting; Startup battery level setting; Backup stop (BS) signal delay time setting; Backup (BU) signal delay time setting; and Contact signal I/O test				

*1. An estimated value for standard mounting. Not a guaranteed value.

*2. Conditions: With rated loads connected, at a rated input voltage, and with the battery fully charged.

*3. Conditions: With rated loads connected, at a rated input voltage, and at the maximum battery charging current.

*4. 400 W for use as a UL compliant device.

*5. 20 A for use as a UL compliant device.

*6. 16.7 A for use as a UL compliant device.

*7. When using in an environment at a high temperature, charging may be paused by charging temperature protection, then the charging time will be longer than specified time.

"CS" will be displayed when charging temperature protection is operated.

Nomenclature

Front view

S8BA-24D24D120LF (120 W)

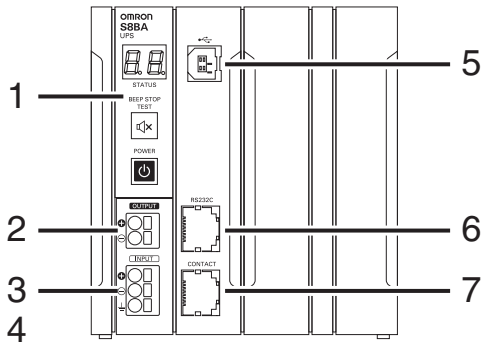

Enlarged view of the operation panel

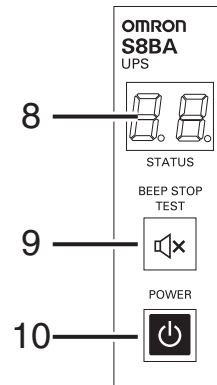

S8BA-24D24D240LF (240 W)

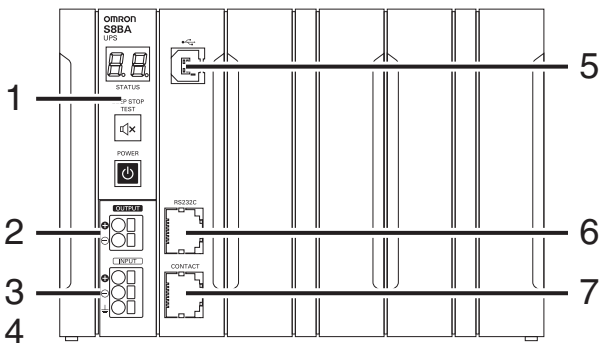

S8BA-24D24D360LF (360 W)

S8BA-24D24D480LF (480 W)

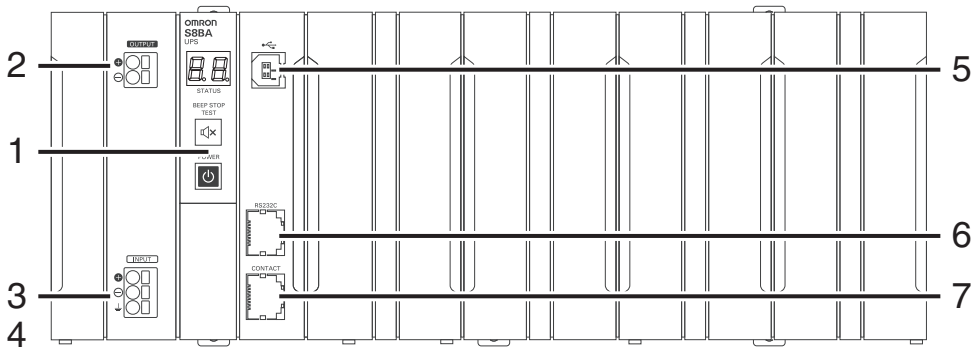

No.	Name	Function
1	Operation panel	Describe the name of each part.
2	DC output terminal block	Connect to load lines.
3	DC input terminal block	Connect to input lines.
4	GR terminal	Ground this terminal to less than 100 Ω to improve noise resistance and prevent electrical shock.
5	USB port	Connect to a USB cable.
6	RS-232C port	Connect to a RS-232C cable.
7	CONTACT port	I/O port. Connect to a signal line.
8	“Status indicator” digital indicator	The seven-segment display indicates the status of the UPS.
9	“Beep Stop/Test” switch	Stop the beeper and perform self-diagnosis testing.
10	“Power” switch	Turn the power of the UPS ON/OFF.

S8BA

Rear view

S8BA-24D24D120LF (120 W)

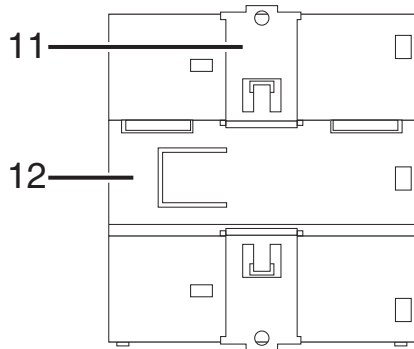

S8BA-24D24D240LF (240 W)

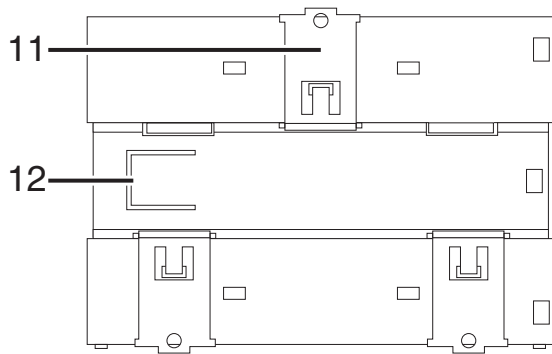

S8BA-24D24D360LF (360 W)

S8BA-24D24D480LF (480 W)

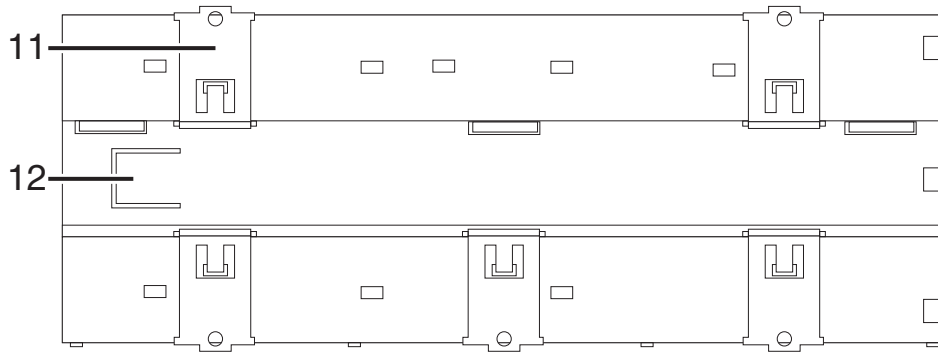

No.	Name	Function
11	DIN rail mounting hook	Hook the UPS on the DIN rail.
12	DIN rail mounting groove	Groove for positioning the DIN rail and the UPS.

Connections

Block Diagrams

S8BA-24D24D□□□LF

Diagram of the Input/output circuit block

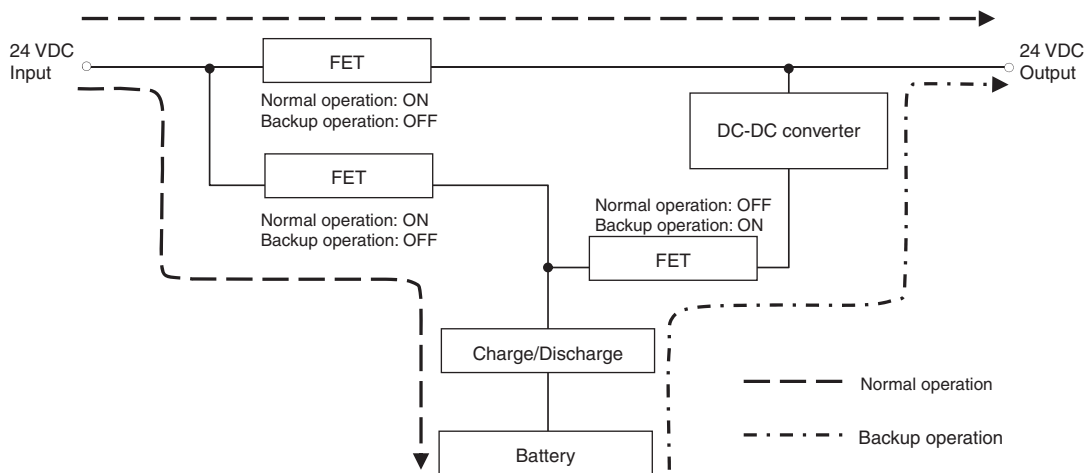

* In normal operation, 24 VDC is output as-is for charging the battery and from the input power supply. If 24 VDC from the input power supply drops, the operation automatically switches to backup operation, and 24 VDC is output from the battery.

Input and output voltage time chart when shifting to backup operation

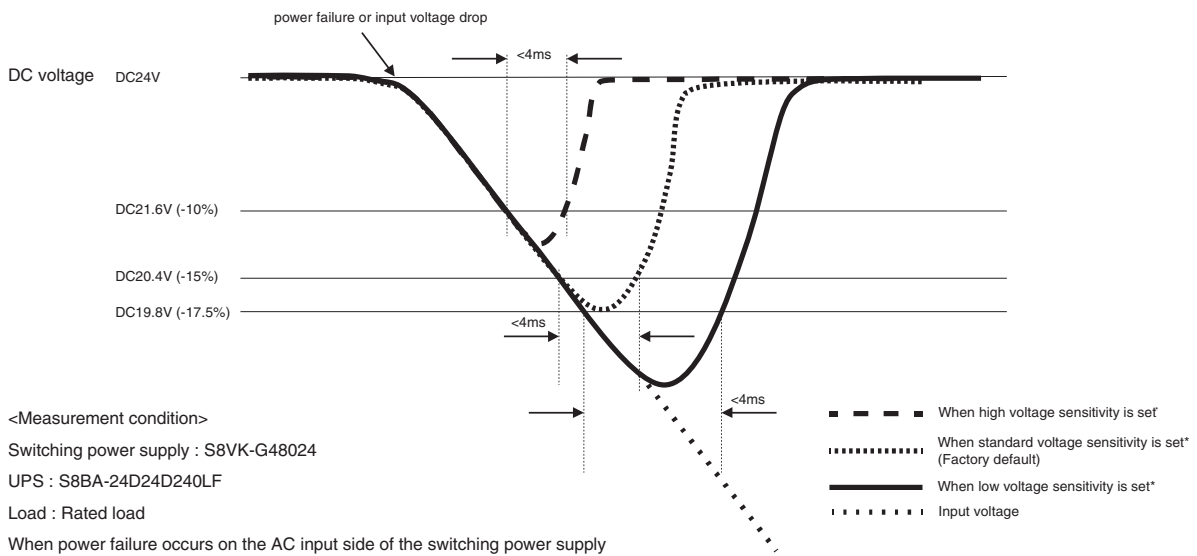

Connecting a cable to the input terminal block and the output terminal block

For details about the connectable sizes and recommended cable sizes, see the following table.

Connectable size	Cable	Solid wire	0.2 to 4.0 mm ²
		Twisted pair	0.2 to 2.5 mm ²
		Twisted pair with a bar terminal	0.25 to 1.5 mm ²
Stripped cable length			8 to 10 mm
Recommended cable size	5 A	Solid wire/Twisted pair	0.5 mm ²
		AWG	AWG20
	10 A	Solid wire/Twisted pair	0.75 mm ²
		AWG	AWG16
	15 A	Solid wire/Twisted pair	1.25 mm ²
		AWG	AWG14
	20 A	Solid wire/Twisted pair	2.0 mm ²
		AWG	AWG12
Temperature rating for recommended cable			90°C

I/O signal functions

Type of output signals

Signal	Description
Backup signal output (BU)	Stays ON during backup operation at a power failure.
Low battery level signal output (BL)	Goes ON when the battery becomes weak during backup operation at a power failure.
Trouble signal output (TR)	Goes ON when an internal failure of the UPS occurs or when the battery life counter expires.
Battery replacement signal output (WB)	Goes ON when the test determines that battery replacement is necessary due to deterioration or when the battery life counter goes off-scale.

Type of input signals

Signal	Description
Input of the UPS stop signal (BS)	When the BS signal is ON (High), the output of the UPS is stopped after the time period specified in advance has elapsed. *
Remote ON/OFF signal	Remote ON/OFF signals can be used to start and stop the UPS, by using either an externally connected contact or the ON/OFF status of the open collector circuit. When signal is OFF, the UPS will be turned on. When signal is ON, the UPS will be turned off. In the factory settings, the UPS stops operation when this is short-circuited. In addition, it is necessary to turn on the "Power" switch of UPS to use this function.

* BS signal delay time

It is possible to set the period of time from when a BS signal is received until the output of the UPS is stopped. The output of the UPS can be stopped by inputting the voltage signal (High).

I/O signal port (RJ45 connector)

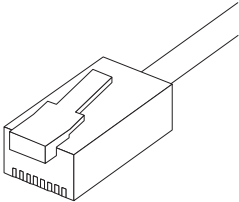
Outlook of the connector	Pin number	Item
	1	Backup signal output (BU)
	2	Remote ON/OFF input (-)
	3	Trouble signal output (TR)
	4	COMMON (COM)
	5	Battery LOW signal output (BL)
	6	Backup stop signal input (BS)
	7	Battery Replacement Signal output (WB)
	8	Remote ON/OFF input (+)

Contact signal ratings

Signal	Description
Signal output (BL, TR, BU, WB)	<ul style="list-style-type: none"> • Photo coupler ratings • Applicable voltage: 5 VDC or less • Maximum current: 360 mA
Remote ON/OFF	<ul style="list-style-type: none"> • Voltage between terminals: 5 VDC • Current when closed: 10 mA max.
UPS Stop Signal input (BS)	<ul style="list-style-type: none"> • Input voltage: HIGH (ON) 8 to 24 VDC LOW (OFF) 0.5 VDC or less • Input current: 1.7 to 5.1 mA

Contact signal circuit

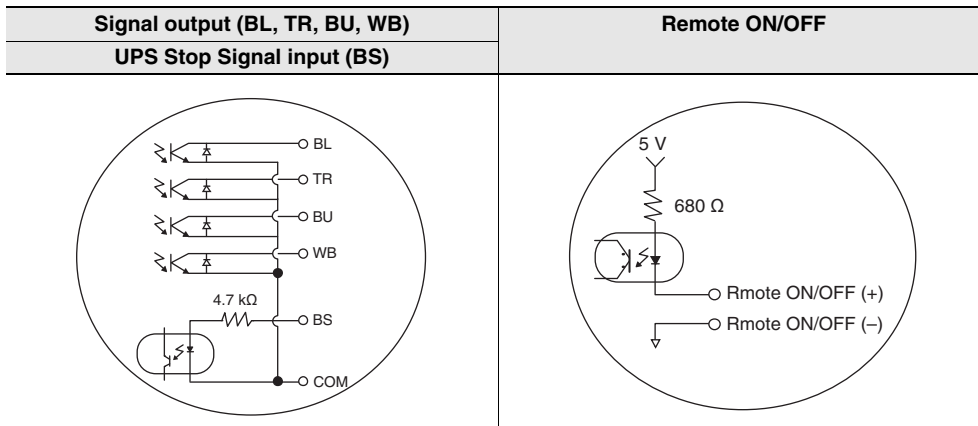

Engineering Data

Estimated backup time

The backup time varies depending on the capacity of connected devices.

After calculating the total capacity of connected devices, refer to the graph of the backup time to obtain an estimation of the initial value of the backup time. (This is also applied to checking the battery.)

1. Convert the total capacity (power consumption) of the connected devices to watts (W).

For the indication of connected devices, check your computer and the rear of the display.

The indicator can show values in two different ways: amperes (A), and watts (W).

Example 1: 24 VDC, 145 W

Example 2: 24 VDC, 1.8 A

Indication	Value
A	$W = A \times 24$

For devices that use the A indication, convert the capacity into W.

Example 2: 1.8 (A) = 1.8×24 (W) = 43.2 (W)

2. Add the values converted into W to obtain the total capacity of the connected devices.

3. Calculate the initial value of the backup time for the total capacity of the connected devices from the graph below.

- Graph of backup time (graph of initial values for products that have not been used at 25°C). The backup time becomes shorter than the graph (table) below when temperature is lower.

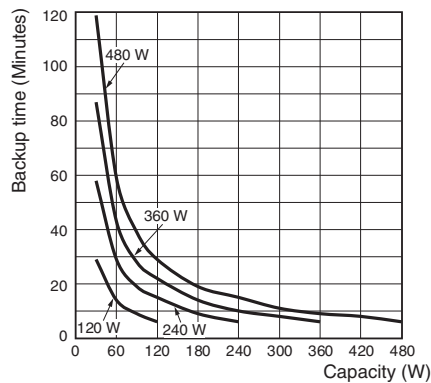

- The smaller the capacity of connected devices becomes, the longer the backup time becomes.

Backup time table

(Time unit: minutes)

	Capacity (W)									
	30	60	90	120	180	240	300	360	420	480
120 W	29	14	9	6	—	—	—	—	—	—
240 W	58	29	19	15	9	6	—	—	—	—
360 W	87	43	28	22	14	10	8	6	—	—
480 W	119	59	39	29	19	15	11	9	8	6

Note: The above backup times are for reference only. They may change depending on the battery life and external environment (such as temperature).

Derating curve

120, 240 W
<S8BA-24D24D120LF>
<S8BA-24D24D240LF>

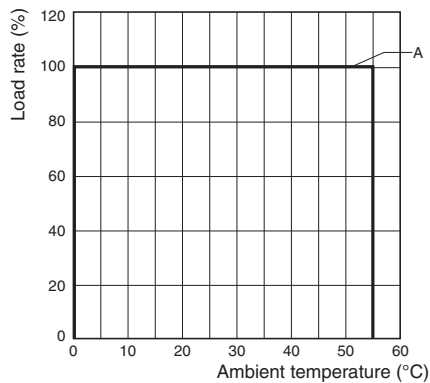

A: For standard mounting, face-up mounting, stationary mounting

360 W
<S8BA-24D24D360LF>

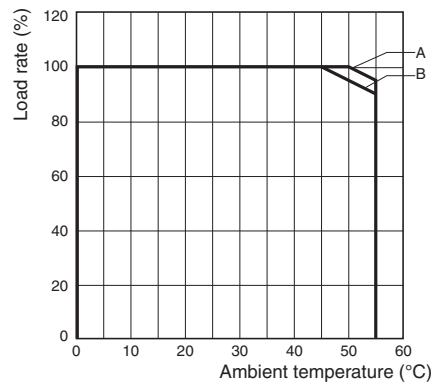

A: For standard mounting,
 B: For face-up mounting, stationary mounting

480 W
<S8BA-24D24D480LF>

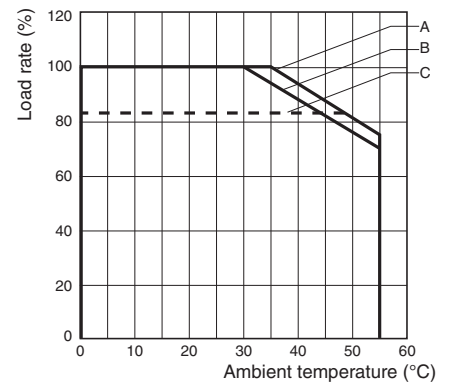

A: For standard mounting,
 B: For face-up mounting, stationary mounting
 C: For standard mounting (For use as a UL compliant device)

Backup operation sequence in the event of power failure/voltage drop (instantaneous voltage drop) When the input power supply recovers while the battery level is sufficiently high

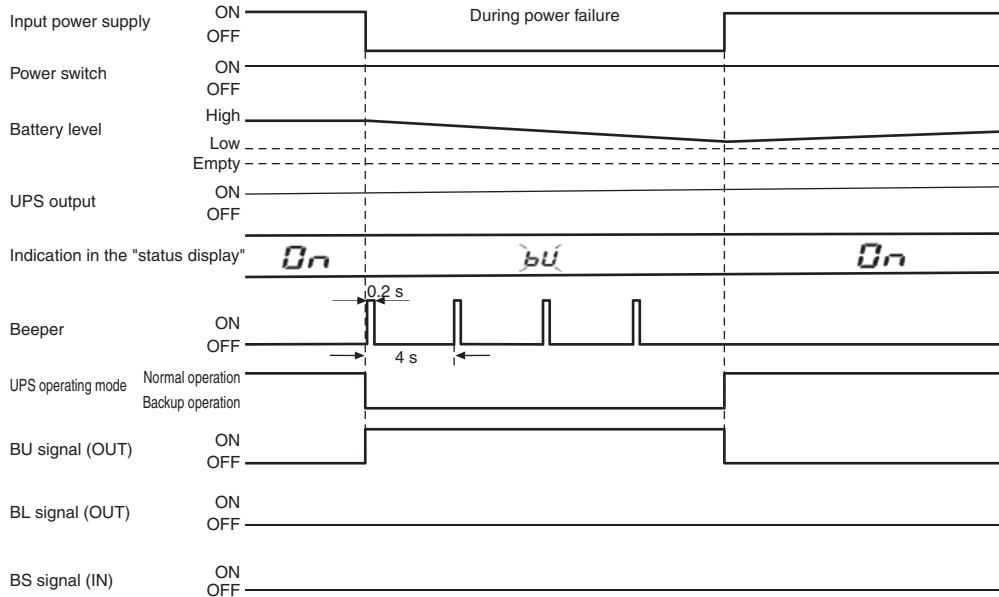

When the input power supply recovers while the battery level is Low

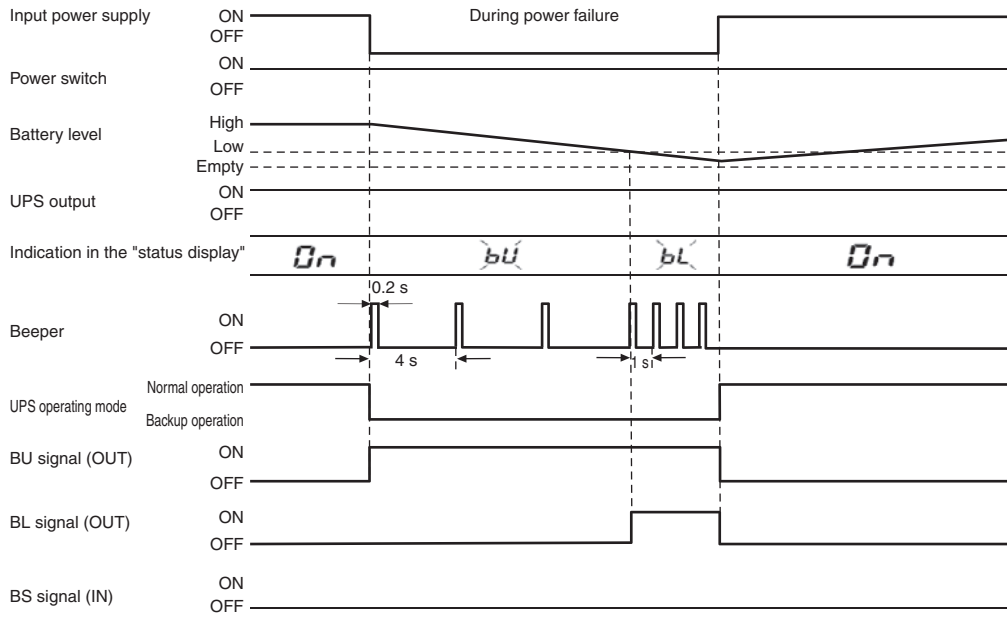

When the input power supply does not recover until the battery becomes empty

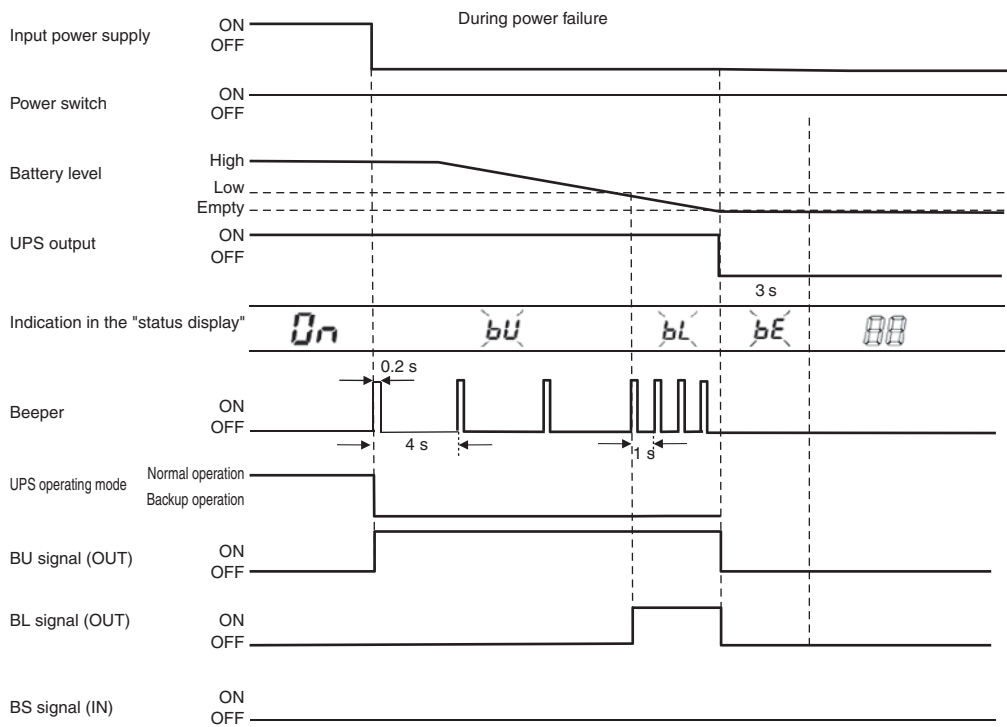

S8BA

Dimensions

(Unit: mm)

Main body

S8BA-24D24D120LF (120 W)

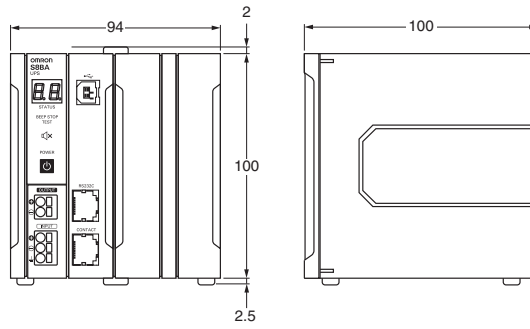

S8BA-24D24D240LF (240 W)

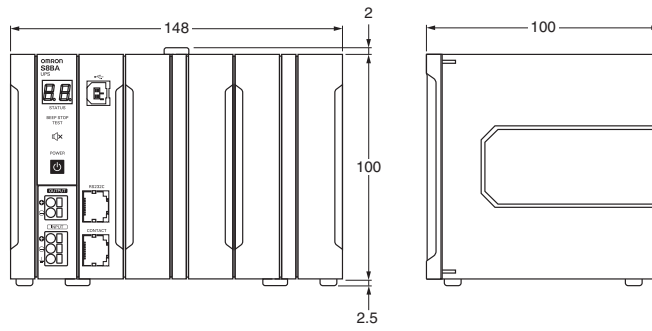

S8BA-24D24D360LF (360 W) S8BA-24D24D480LF (480 W)

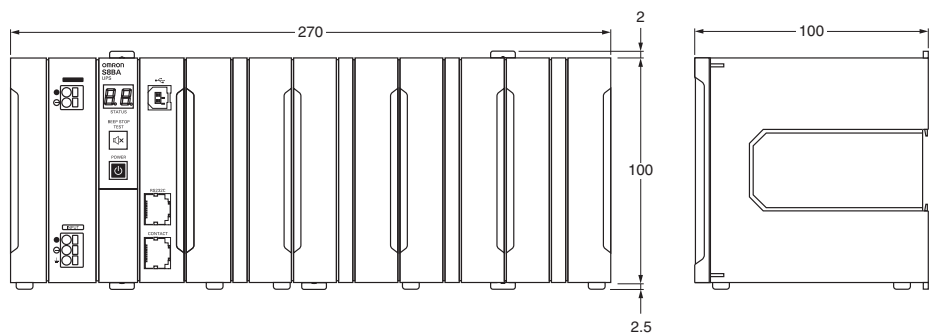

DIN Rail (Order Separately)

Mounting Rail (Material: Aluminum)

PFP-100N

PFP-50N

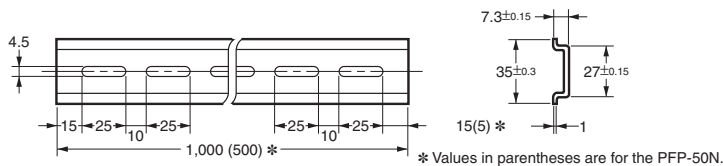
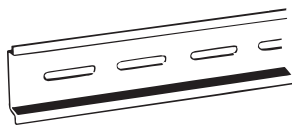

Mounting Rail (Material: Aluminum)

PFP-100N2

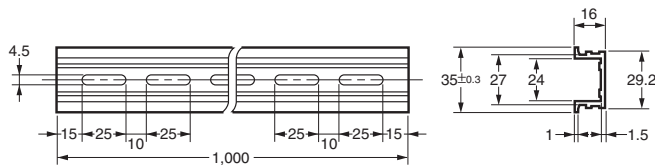
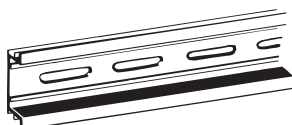

End Plate

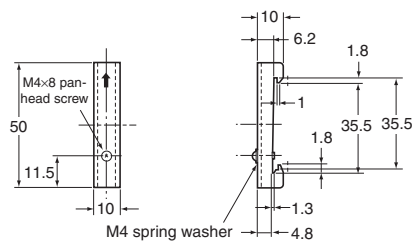

PFP-M









- Note:**
1. If there is a possibility that the Unit will be subject to vibration or shock, use a steel DIN Rail. Otherwise, metallic filings may result from aluminum abrasion.
 2. If the Unit may be subjected to sliding to either side, attach an End Plate (model PFP-M) on each side of the Unit.

Safety Precautions

Warning Indications

 Warning	Indicates a potentially hazardous situation that, if not avoided, could result in serious injury or death. Additionally there may be significant property damage.
 Caution	Indicates a potentially hazardous situation that, if not avoided, could result in minor or moderate injury or property damage.

Meaning of Product Safety Symbols

	General inhibition Notice prohibiting an unspecified general action.
	General instruction Notice instructing an unspecified general action.
	Do-not-disassemble prohibition Notice prohibiting disassembly because disassembling the device may cause such an accident as an electric shock.
	Prohibition of use in locations subject to water such as a bathroom and shower room Notice prohibiting installation of the device in locations subject to water, because if a device not made water-proof is used in such locations, injury may occur due to an electric leak.
	Do-not-touch prohibition Indicates the possibility of injuries by touching the specific portion of the device under specific conditions, prohibiting touching of the device.
	Explosion alert Notice alerting the user to the possibility of explosion under certain conditions.

Warning

(for use of this product)

- Provide safety measures in external circuits, not in the UPS, in order to ensure safety in the system if an abnormality occurs due to malfunction of the UPS or another external factor affecting the UPS operation. Not doing so may result in serious accidents. 

Caution

(for installation and connection)

- Carry the unit considering its weight and balance, and place it on a stable and robust base. 
- If you drop the unit, the battery or the battery protection mechanism may be broken, and it may result eventually in a fluid leak, abnormal heating, smoke, rupture or fire.
 - If you drop the unit, stop using it and have it inspected and repaired.
For details on repair, contact the OMRON representative.

- Keep plastic package bags out of reach of children. 
- Children may suffocate if they place their heads into plastic bags.

- Make sure to connect the “input power supply” to the DC power supply device with a rated voltage (24 VDC). 
- The input voltage ranges for the UPS are as shown below. Check that the output voltage of the DC power supply device connected to the input terminal of the UPS is within any of the voltage ranges below.
 - 24 VDC±10% (Input voltage range: When standard voltage sensitivity is set)
 - 24 VDC±12.5% (Input voltage range: When low voltage sensitivity is set)
 - 24 VDC±5% (Input voltage range: When high voltage sensitivity is set)
 - Connecting to a DC or AC power supply device with a different voltage may result in malfunction in or damage to the UPS, or cause a fire.

- When an abnormality (unusual sound or smell) occurs, turn OFF the unit’s “Power” switch to stop the output, and stop the supply of commercial power. 
- When performing maintenance on the connected devices, follow the above instructions to ensure safety.

- When installing the input cable, make sure to perform the connection as specified. 
- Make sure to stop the primary power supply before connecting the unit to the input power supply terminal.
- When connecting a cable to the terminal block, use a cable that complies with the input current specification of the UPS. Failure to do so may result in electric shock or ground fault.

- Do not disassemble, repair, or modify the unit. 
- Doing so may cause an electric shock or a fire.

- Do not install the unit in other than specified orientations. 
- Dropping or toppling the unit may cause injury.
 - If the UPS is not installed in the specified direction, the internal temperature may rise, eventually damaging the UPS or deteriorating the battery.

- Do not use the unit where the maximum temperature exceeds 55°C. 
- The battery deteriorates rapidly.
 - If the battery’s resin separator is damaged, the battery may be short-circuited inside, and may cause an abnormal heating, smoke, rupture or fire.
 - Doing so may cause a failure or malfunction of the unit.

- Do not exceed the ranges specified for environmental conditions during use/storage. 
- Do not install or store the unit in the places listed below.
- Do not store in places where the humidity is lower than 10% or higher than 90%.
 - Do not use the unit in places where the ambient temperature is lower than 0°C or higher than 55°C. (With no condensation)
 - Do not use in places where the humidity is lower than 10% or higher than 90%.
 - Do not install/store the unit in closed places such as cabinets with no clearance, places where there is flammable or corrosive gas,
 - Places with large amounts of dust, places exposed to direct sunlight, places exposed to shock or vibration, salty or wet places, or outdoors.
 - Installation or storing the unit in such a place may cause a fire.

When you use plug strip and other plugs to connect additional devices, do not connect devices that exceed the current capacity of the available plugs.

- The current protection of the unit may operate, which may stop the output.
- The cable heats up, which may cause a fire.



Do not pinch or sharply bend the cable.

Do not fold or knot the cable.

- Doing so may cause the cable to be damaged or heated, which may cause an electric shock or a fire.
- If the cable is damaged, stop using the unit and have the cable repaired.
- For details on repair, contact our sales personnel.



Connect only devices using 24 VDC rated voltage.

- The rated output voltage of the UPS is 24 VDC.
- Overvoltage or overcurrent may damage the connected devices.



All the accessories contained in the product package can be used for the UPS only. Do not use any of them for other devices.

- Be sure to observe this to use the UPS safely.



Include a breaker between the "input power supply" of the UPS and the DC power supply devices. And, install the breaker where it is easy to operate.



To use this product as a CE marking compliant device, use a 2-meter or shorter connection cable.



Do not block the air vents (upper and lower).

- Doing so will cause the internal temperature to rise, which may cause the unit to fail and the battery to deteriorate.
- For stationary installation, leave a space of 50 mm or more above the top, and for installation using a DIN rail and screw clamps, leave a space of 50 mm or more above the top and below the bottom each.



Do not connect the RS232C port or the CONTACT port to a LAN device using a LAN cable.

- Connection to a LAN device may result in malfunction in or damage to the UPS or the LAN device.



(for use)

Do not allow the unit to come in contact with water. If you drop the unit, stop using it.

- Doing so may cause an electric shock or a fire.
- Doing so may cause an abnormal heating, smoke, rupture, or fire on the battery.
- If the unit becomes wet or is dropped, immediately stop using it, disconnect the input power supply from the wall outlet (commercial power source) and have it inspected and repaired.
- For details on repair, contact our sales personnel.



When the battery is dead, replace it immediately or stop using the unit.

- Continuing the use of it may cause fire or electric shock due to liquid leaks.



Ambient temperature	Expected life
50°C	2.5 years
40°C	5 years
25°C	10 years

* The values in the table are the expected life under standard use conditions and are not guaranteed.

Occasionally, wipe off dust on the input terminal block and the output terminal block with a dry cloth.

- Accumulated dust may cause a fire.
- Before wiping off dust, stop all connected devices and the unit, and stop the supply of commercial power.



Do not use the unit in a closed place and do not cover the unit.

- Doing so may cause abnormal heating or a fire.



If you notice something unusual such as abnormal sound or smell, discoloration, deformation, and heating, turn OFF the unit's "Power" switch to stop the output and stop the supply from the "input power supply".

- Using the unit under such conditions may cause an abnormal heating, rupture or fire.
- If this situation arises, be sure to stop using the UPS and request our sales personnel for inspection and repair.
- A readily accessible disconnect device shall be incorporated external to the equipment.



If fluid leaks from the interior, do not touch the fluid.

- Doing so may cause blindness or burns.
- If the fluid contacts your eyes or skin, wash it out with lots of clean water and consult your doctor. The fluid may damage your eye if your eye is left untreated.



Do not place any objects on the unit, and do not drop heavy objects onto the unit.

- Doing so may cause distortion/damage to the case or a failure of the internal circuit, which may cause a fire.



The unit is equipped with a bypass circuit which is able to supply electric power to connected devices even when the inner control circuit is broken down by defects or malfunctions.

- If you want to stop the output, stop the source of the "input power supply".
- Output is continuing even when all indicators of the front panel are off.
- Output ON/OFF cannot be controlled with the "Power" switch on the front panel.



When charging the battery, if the battery cannot be charged completely even after the predetermined charging time, turn OFF the "Power" switch of the unit to stop charging the battery.

- Otherwise, it may cause an abnormal heating, smoke, rupture or fire on the battery.



(for maintenance)

When maintaining the connected equipment, turn OFF the unit's "Power" switch to stop the output, and stop the supply of the "input power supply".

- Even if the input power supply to the UPS is stopped while it is in operation, the power output of his unit does not stop and power is supplied from the battery.



Do not disassemble, repair, or modify the unit.

- Doing so may cause an electric shock or a fire.



If fluid leaks from the interior, do not touch the fluid.

- Doing so may cause blindness or burns.
- If the fluid contacts your eyes or skin, wash it out with lots of clean water and consult your doctor.



Do not throw the unit into fire.

- Since the battery is incorporated in the unit, the insulator may melt, the gas exhaust valve or protection mechanism may be damaged, or the electrolyte may catch fire, and it may result eventually in an abnormal heating, smoke, rupture or fire.



Do not insert metal objects into the input terminal block and the output terminal block of the UPS.

- Doing so may result in electric shock.



Do not insert metal objects into the battery connectors. Do not short between the connector terminals.

- Doing so may result in electric shock.
- The battery's protection board may be damaged due to a short-circuit.



(for battery replacement)

Risk of explosion if battery is replaced by an incorrect type.

- Not doing so may cause a fire.
- Battery pack for; product model: S8BA-B120L.



Do not replace the battery in a place where there is flammable gas.

- Spark may occur when connecting the battery, which may cause an explosion or fire.



If fluid leaks from the battery, do not touch the fluid.

- Doing so may cause blindness or burns.
- If the fluid contacts your eyes or skin, wash it out with lots of clean water and consult your doctor.



Do not disassemble or modify the battery.

- A safety mechanism and protection mechanism to prevent danger are embedded into the battery. If they are damaged, it may cause an abnormal heating, smoke, rupture or fire on the battery.



Do not drop the battery and do not expose it to strong impact.

- Doing so may cause a leakage, abnormal heating, smoke, rupture or fire on the battery. And, if the battery's protection mechanism is broken, the battery may be charged at an abnormal current or voltage, an abnormal chemical reaction may occur inside the battery, and it may result eventually in an abnormal heating, smoke, rupture or fire.



Do not short the battery with metal objects.

- Doing so could cause an electric shock, fire or burn.
- Some electrical energy still remains inside the spent battery.



Do not dispose of battery in a fire or damage battery.

- The insulator inside the battery may melt, the gas exhaust valve or protection mechanism may be damaged, or the electrolyte may catch fire, and it may result eventually in abnormal heating, smoke, rupture or fire.



Do not use a new battery and an old battery at the same time.

- The battery may be excessively discharged while being used or excessively charged while being charged, an abnormal chemical reaction may occur inside the battery, and it may result eventually in an abnormal heating, smoke, rupture or fire.
- A battery can present a risk of electrical shock and high short circuit current.
- Contact with any part of a grounded battery can result in electrical shock.



- The following precautions should be observed when working on batteries:
 - (a) Remove watches, rings, or other metal objects.
 - (b) Use screwdrivers with insulated handles.
 - (c) Wear rubber gloves and boots.
 - (d) Do not lay tools or metal parts on top of batteries.
 - (e) Remove the connection from ground if any part of the battery is determined to be grounded.

Dispose of or collect (recycle) the battery according to your own rules set for that purpose or as instructed by laws and regulations.

Do not dispose of it in fire. Otherwise, it could explode.



Precautions for Safe Use

Before using

Charge the battery soon after purchasing the unit.

- If not used for a long time after being purchased, the UPS may become unusable because the characteristics of its battery become inferior.
- Connect the UPS to the input power supply and turn ON the "Power" switch to charge the battery.

If the UPS is moved from a warm place to a cold place, start using it after leaving it as-is for a few hours.

- If the UPS is suddenly moved to a warm place, water may adhere to it (condensation). In such a case, if power is supplied without checking the condition, the UPS may be damaged.
- Take measures against the unexpected events such as protecting data and making the system redundant.
- The UPS may stop its power due to failure.

For Connection

Be careful not to let a short-circuit occur between output lines of the UPS and not to let an output line and the ground be short-circuited (a ground fault).

- Otherwise, the UPS may be damaged.

To transfer or sell the UPS to a third party, attach all the documents and other accessories contained in the product package to the UPS.

It is supposed that the UPS is to be used in accordance with the conditions specified in the attached documents.

- The details related to safety are described in this document. Check the details before using the UPS. In case you lose this document, download a copy from the Omron Website.

While Using the UPS

Turn OFF the "Power" switch of the UPS before turning OFF the input power supply.

- When the input power supply is stopped, backup operation starts.
- If the frequency of backup operation becomes high, the battery life may be significantly reduced.

Do not use the UPS for purposes requiring frequent backup operation.

- The battery will deteriorate and become unable to last for the specified backup time.

For Storage

To store the UPS for a long time, store it in an environment where the ambient temperature is 25°C or lower, and charge the battery once every year for 10 to 15 minutes.

- The battery discharges itself even if it is not used. If the battery is left unused for a long time, it goes into a state of over-discharge. In such a case, the backup time may become shorter, or the battery cannot be used anymore.
- We recommend an environment where the ambient temperature is 25°C or lower to store the UPS for a long time.
- Keep the "Power" switch of the UPS turned OFF during storage.
- Do not install or store the UPS in a location exposed to direct sunlight.
- The built-in battery may deteriorate rapidly due to an increase in temperature and become unusable.

Correct Installation Method

- For installation, to improve the long time reliability of the UPS, pay much attention to heat dissipation. Ensure convection of air around the UPS main body, and use the UPS in an operating condition below the derating curve.
- During machining work for mounting, make sure that no metal scrap goes into the product.
- The heat dissipation of the UPS may become worse depending on how the UPS is mounted; in rare cases, internal components may deteriorate and get damaged. Use the UPS in an operating condition based on the derating curve for each mounting direction.

Standard mounting (Mounting to the DIN rail)

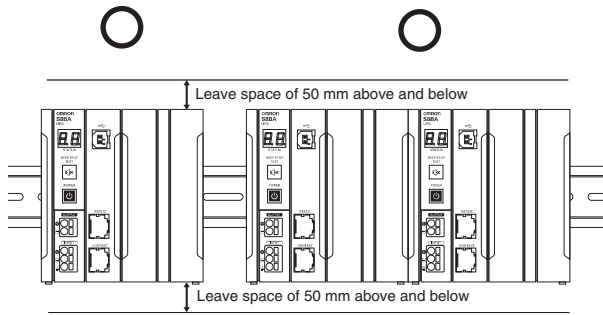

To install devices other than the UPS to both sides, install them by leaving a space specified by each device off the UPS.

Stationary mounting

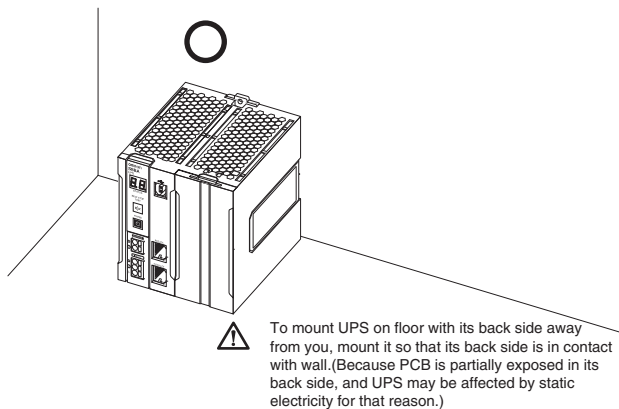

Face-up mounting

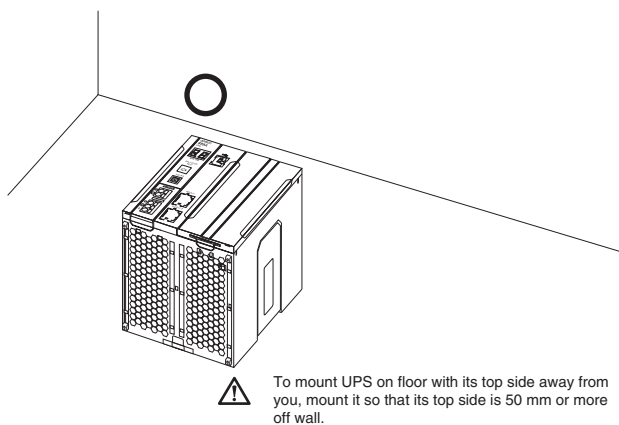

Incorrect Installation Method
Mounting to the DIN Track

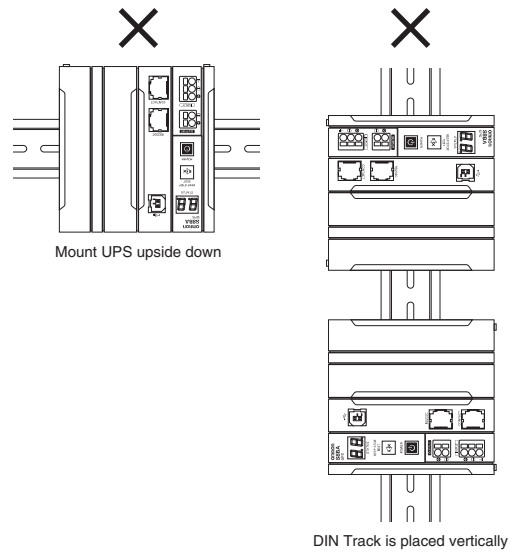

Stationary installation

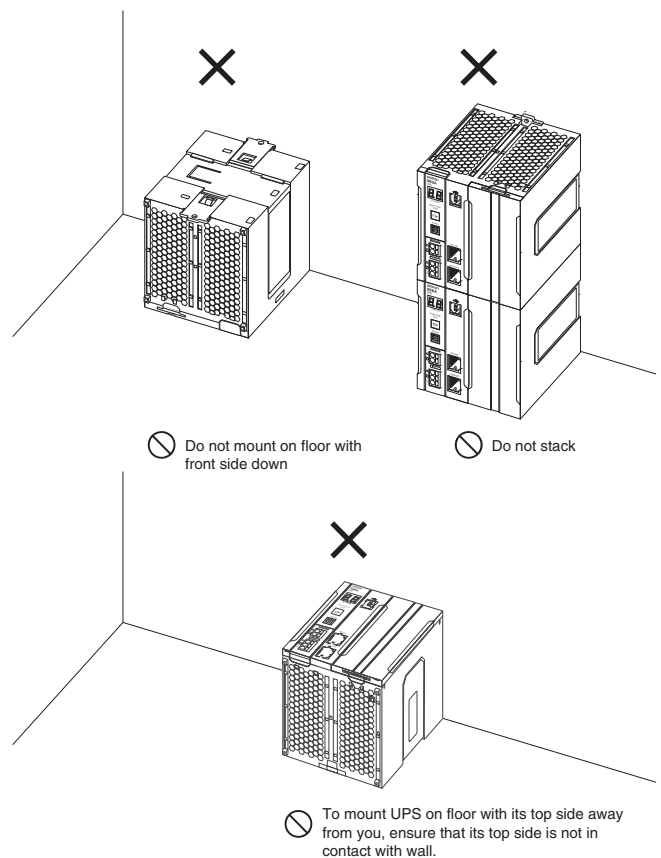

Battery Replacement

The UPS supports hot swapping. Battery replacement is possible both when the power is turned OFF (while the power output is OFF) and when the power is turned ON (while the power output is ON).

Precautions for Correct Use

- For battery replacement, hold down the “Buzzer Pause/Test” switch on the unit for 10 seconds or longer to activate the battery replacement mode. When “bL” is displayed, the activation is completed.
 - * Activate the battery replacement mode while the “input power supply” is turned ON. If you replace the battery without activating the battery replacement mode, the battery life may not be detected accurately because the battery life counter is not reset.
- Do not replace the battery during backup operation. Otherwise, the output stops.

The life of the battery used in the UPS is limited. This life changes depending on the use environment and the frequency of backup operation.

- As the battery life comes closer to its end, the battery deteriorates more rapidly. Be careful.

The storage condition also affects the deterioration of the battery. As the storage temperature becomes higher, the battery life becomes shorter. Be careful.

Battery check schedule and frequency

Ambient temperature	6-Month Inspection	3-Month Inspection
55°C	Up to 1 year from the date of purchase	1 year from the date of purchase and afterward
50°C	Up to 1.5 years from the date of purchase	1.5 years from the date of purchase and afterward
40°C	Up to 3 year from the date of purchase	3 years from the date of purchase and afterward
25°C	Up to 6 year from the date of purchase	6 years from the date of purchase and afterward

Conformance to EC Directives

Applicable directives

- EMC Directives
- Low Voltage Directives

Principles regarding conformance

OMRON electronic devices that comply with EC Directives also conform to the related EMC standards so that they can be more easily built into other devices or the overall machine. The actual products have been checked for conformity to EMC standards*.

Whether the products conform to the standards in the system used by the customer, however, must be checked by the customer. EMC-related performance of the OMRON devices that comply with EC Directives will vary depending on the configuration, wiring, and other conditions of the equipment or control panel on which the OMRON devices are installed. The customer must, therefore, perform the final check to confirm that devices and the overall machine conform to EMC standards.

* Applicable EMC (Electromagnetic Compatibility) standards are as follows: EMS (Electromagnetic Susceptibility): EN 61000-6-2, EMI (Electromagnetic Interference): EN 61000-6-4, and EN 61000-6-4 Radiated emission: 10-m regulations

Low Voltage Directives

Always ensure that devices operating at voltages of AC 50 to 1,000 V and DC 75 to 1,500 V meet the required safety standards. The applicable directive is EN60950-1.

Conformance to EC Directives

This product complies with EC Directives. To ensure that the machine or device in which the this product is used complies with EC Directives, the product must be installed as follows:

- This product must be installed within a control panel.
- You must use reinforced insulation or double insulation for the DC power supply connected to this product.
- Models of this product that comply with EC Directives also conform to the Common Emission Standard. Radiated emission characteristics (10-m regulations), in particular, may vary depending on the configuration of the control panel used, other devices connected to the control panel, wiring, and other conditions. Therefore, even when using a model of this product that complies with EC Directives, you must confirm and ensure the compliance to EC Directives of the entire machine or equipment.
- This is a Class A product (for industrial environments). In a residential environment, it may cause radio interference. If radio interference occurs, the user may be required to take appropriate measures.

Conformance to UL

Conformance to UL

- This product must be installed within a control panel with an internal heater or other unit to protect against the formation of condensation.
- Gaps in the door to the control panel must be completely filled or covered with gaskets or other material.
- For use as a UL compliant device, the specifications for S8BA-24D24D480LF become as follows:
 - Maximum input current: 20 A
 - Rated output current/capacity: 16.7 A/400 W
- For use in Pollution Degree 2 Environment.
- Surrounding Air Temperature, 55°C.
- Make sure to connect the device with Class 2 output to the USB port.

Terms and Conditions of Sale

1. **Offer; Acceptance.** These terms and conditions (these "Terms") are deemed part of all quotes, agreements, purchase orders, acknowledgments, price lists, catalogs, manuals, brochures and other documents, whether electronic or in writing, relating to the sale of products or services (collectively, the "Products") by Omron Electronics LLC and its subsidiary companies ("Omron"). Omron objects to any terms or conditions proposed in Buyer's purchase order or other documents which are inconsistent with, or in addition to, these Terms.
2. **Prices; Payment Terms.** All prices stated are current, subject to change without notice by Omron. Omron reserves the right to increase or decrease prices on any unshipped portions of outstanding orders. Payments for Products are due net 30 days unless otherwise stated in the invoice.
3. **Discounts.** Cash discounts, if any, will apply only on the net amount of invoices sent to Buyer after deducting transportation charges, taxes and duties, and will be allowed only if (i) the invoice is paid according to Omron's payment terms and (ii) Buyer has no past due amounts.
4. **Interest.** Omron, at its option, may charge Buyer 1-1/2% interest per month or the maximum legal rate, whichever is less, on any balance not paid within the stated terms.
5. **Orders.** Omron will accept no order less than \$200 net billing.
6. **Governmental Approvals.** Buyer shall be responsible for, and shall bear all costs involved in, obtaining any government approvals required for the importation or sale of the Products.
7. **Taxes.** All taxes, duties and other governmental charges (other than general real property and income taxes), including any interest or penalties thereon, imposed directly or indirectly on Omron or required to be collected directly or indirectly by Omron for the manufacture, production, sale, delivery, importation, consumption or use of the Products sold hereunder (including customs duties and sales, excise, use, turnover and license taxes) shall be charged to and remitted by Buyer to Omron.
8. **Financial.** If the financial position of Buyer at any time becomes unsatisfactory to Omron, Omron reserves the right to stop shipments or require satisfactory security or payment in advance. If Buyer fails to make payment or otherwise comply with these Terms or any related agreement, Omron may (without liability and in addition to other remedies) cancel any unshipped portion of Products sold hereunder and stop any Products in transit until Buyer pays all amounts, including amounts payable hereunder, whether or not then due, which are owing to it by Buyer. Buyer shall in any event remain liable for all unpaid accounts.
9. **Cancellation; Etc.** Orders are not subject to rescheduling or cancellation unless Buyer indemnifies Omron against all related costs or expenses.
10. **Force Majeure.** Omron shall not be liable for any delay or failure in delivery resulting from causes beyond its control, including earthquakes, fires, floods, strikes or other labor disputes, shortage of labor or materials, accidents to machinery, acts of sabotage, riots, delay in or lack of transportation or the requirements of any government authority.
11. **Shipping; Delivery.** Unless otherwise expressly agreed in writing by Omron:
 - a. Shipments shall be by a carrier selected by Omron; Omron will not drop ship except in "break down" situations.
 - b. Such carrier shall act as the agent of Buyer and delivery to such carrier shall constitute delivery to Buyer;
 - c. All sales and shipments of Products shall be FOB shipping point (unless otherwise stated in writing by Omron), at which point title and risk of loss shall pass from Omron to Buyer; provided that Omron shall retain a security interest in the Products until the full purchase price is paid;
 - d. Delivery and shipping dates are estimates only; and
 - e. Omron will package Products as it deems proper for protection against normal handling and extra charges apply to special conditions.
12. **Claims.** Any claim by Buyer against Omron for shortage or damage to the Products occurring before delivery to the carrier must be presented in writing to Omron within 30 days of receipt of shipment and include the original transportation bill signed by the carrier noting that the carrier received the Products from Omron in the condition claimed.
13. **Warranties.** (a) **Exclusive Warranty.** Omron's exclusive warranty is that the Products will be free from defects in materials and workmanship for a period of twelve months from the date of sale by Omron (or such other period expressed in writing by Omron). Omron disclaims all other warranties, express or implied. (b) **Limitations.** OMRON MAKES NO WARRANTY OR REPRESENTATION, EXPRESS OR IMPLIED, ABOUT NON-INFRINGEMENT, MERCHANTABILITY OR FITNESS FOR A PARTICULAR PURPOSE OF THE PRODUCTS. BUYER ACKNOWLEDGES THAT IT ALONE HAS DETERMINED THAT THE PRODUCTS WILL SUITABLY MEET THE REQUIREMENTS OF THEIR INTENDED USE. Omron further disclaims all warranties and responsibility of any type for claims or expenses based on infringement by the Products or otherwise of any intellectual property right. (c) **Buyer Remedy.** Omron's sole obligation hereunder shall be, at Omron's election, to (i) replace (in the form originally shipped with Buyer responsible for labor charges for removal or replacement thereof) the non-complying Product, (ii) repair the non-complying Product, or (iii) repay or credit Buyer an amount equal to the purchase price of the non-complying Product; provided that in no event shall Omron be responsible for warranty, repair, indemnity or any other claims or expenses regarding the Products unless Omron's analysis confirms that the Products were properly handled, stored, installed and maintained and not subject to contamination, abuse, misuse or inappropriate modification. Return of any Products by Buyer must be approved in writing by Omron before shipment. Omron Companies shall not be liable for the suitability or unsuitability or the results from the use of Products in combination with any electrical or electronic components, circuits, system assemblies or any other materials or substances or environments. Any advice, recommendations or information given orally or in writing, are not to be construed as an amendment or addition to the above warranty. See <http://www.omron247.com> or contact your Omron representative for published information.
14. **Limitation on Liability; Etc.** OMRON COMPANIES SHALL NOT BE LIABLE FOR SPECIAL, INDIRECT, INCIDENTAL, OR CONSEQUENTIAL DAMAGES, LOSS OF PROFITS OR PRODUCTION OR COMMERCIAL LOSS IN ANY WAY CONNECTED WITH THE PRODUCTS, WHETHER SUCH CLAIM IS BASED IN CONTRACT, WARRANTY, NEGLIGENCE OR STRICT LIABILITY. Further, in no event shall liability of Omron Companies exceed the individual price of the Product on which liability is asserted.
15. **Indemnities.** Buyer shall indemnify and hold harmless Omron Companies and their employees from and against all liabilities, losses, claims, costs and expenses (including attorney's fees and expenses) related to any claim, investigation, litigation or proceeding (whether or not Omron is a party) which arises or is alleged to arise from Buyer's acts or omissions under these Terms or in any way with respect to the Products. Without limiting the foregoing, Buyer (at its own expense) shall indemnify and hold harmless Omron and defend or settle any action brought against such Companies to the extent based on a claim that any Product made to Buyer specifications infringed intellectual property rights of another party.
16. **Property; Confidentiality.** Any intellectual property in the Products is the exclusive property of Omron Companies and Buyer shall not attempt to duplicate it in any way without the written permission of Omron. Notwithstanding any charges to Buyer for engineering or tooling, all engineering and tooling shall remain the exclusive property of Omron. All information and materials supplied by Omron to Buyer relating to the Products are confidential and proprietary, and Buyer shall limit distribution thereof to its trusted employees and strictly prevent disclosure to any third party.
17. **Export Controls.** Buyer shall comply with all applicable laws, regulations and licenses regarding (i) export of products or information; (ii) sale of products to "forbidden" or other proscribed persons; and (iii) disclosure to non-citizens of regulated technology or information.
18. **Miscellaneous.** (a) **Waiver.** No failure or delay by Omron in exercising any right and no course of dealing between Buyer and Omron shall operate as a waiver of rights by Omron. (b) **Assignment.** Buyer may not assign its rights hereunder without Omron's written consent. (c) **Law.** These Terms are governed by the law of the jurisdiction of the home office of the Omron company from which Buyer is purchasing the Products (without regard to conflict of law principles). (d) **Amendment.** These Terms constitute the entire agreement between Buyer and Omron relating to the Products, and no provision may be changed or waived unless in writing signed by the parties. (e) **Severability.** If any provision hereof is rendered ineffective or invalid, such provision shall not invalidate any other provision. (f) **Setoff.** Buyer shall have no right to set off any amounts against the amount owing in respect of this invoice. (g) **Definitions.** As used herein, "including" means "including without limitation"; and "Omron Companies" (or similar words) mean Omron Corporation and any direct or indirect subsidiary or affiliate thereof.

Certain Precautions on Specifications and Use

1. **Suitability of Use.** Omron Companies shall not be responsible for conformity with any standards, codes or regulations which apply to the combination of the Product in the Buyer's application or use of the Product. At Buyer's request, Omron will provide applicable third party certification documents identifying ratings and limitations of use which apply to the Product. This information by itself is not sufficient for a complete determination of the suitability of the Product in combination with the end product, machine, system, or other application or use. Buyer shall be solely responsible for determining appropriateness of the particular Product with respect to Buyer's application, product or system. Buyer shall take application responsibility in all cases but the following is a non-exhaustive list of applications for which particular attention must be given: (i) Outdoor use, uses involving potential chemical contamination or electrical interference, or conditions or uses not described in this document. (ii) Use in consumer products or any use in significant quantities. (iii) Energy control systems, combustion systems, railroad systems, aviation systems, medical equipment, amusement machines, vehicles, safety equipment, and installations subject to separate industry or government regulations. (iv) Systems, machines and equipment that could present a risk to life or property. Please know and observe all prohibitions of use applicable to this Product. NEVER USE THE PRODUCT FOR AN APPLICATION INVOLVING SERIOUS RISK TO LIFE OR PROPERTY OR IN LARGE QUANTITIES WITHOUT ENSURING THAT THE SYSTEM AS A WHOLE HAS BEEN DESIGNED TO ADDRESS THE RISKS, AND THAT THE OMRON'S PRODUCT IS PROPERLY RATED AND INSTALLED FOR THE INTENDED USE WITHIN THE OVERALL EQUIPMENT OR SYSTEM.
2. **Programmable Products.** Omron Companies shall not be responsible for the user's programming of a programmable Product, or any consequence thereof.
3. **Performance Data.** Data presented in Omron Company websites, catalogs and other materials is provided as a guide for the user in determining suitability and does not constitute a warranty. It may represent the result of Omron's test conditions, and the user must correlate it to actual application requirements. Actual performance is subject to the Omron's Warranty and Limitations of Liability.
4. **Change in Specifications.** Product specifications and accessories may be changed at any time based on improvements and other reasons. It is our practice to change part numbers when published ratings or features are changed, or when significant construction changes are made. However, some specifications of the Product may be changed without any notice. When in doubt, special part numbers may be assigned to fix or establish key specifications for your application. Please consult with your Omron's representative at any time to confirm actual specifications of purchased Product.
5. **Errors and Omissions.** Information presented by Omron Companies has been checked and is believed to be accurate; however, no responsibility is assumed for clerical, typographical or proofreading errors or omissions.

OMRON AUTOMATION AND SAFETY • THE AMERICAS HEADQUARTERS • Chicago, IL USA • 847.843.7900 • 800.556.6766 • www.omron247.com

OMRON CANADA, INC. • HEAD OFFICE

Toronto, ON, Canada • 416.286.6465 • 866.986.6766 • www.omron247.com

OMRON ELECTRONICS DE MEXICO • HEAD OFFICE

México DF • 52.55.59.01.43.00 • 01-800-226-6766 • mela@omron.com

OMRON ELECTRONICS DE MEXICO • SALES OFFICE

Apodaca, N.L. • 52.81.11.56.99.20 • 01-800-226-6766 • mela@omron.com

OMRON ELETRÔNICA DO BRASIL LTDA • HEAD OFFICE

São Paulo, SP, Brasil • 55.11.2101.6300 • www.omron.com.br

OMRON ARGENTINA • SALES OFFICE

Cono Sur • 54.11.4783.5300

OMRON CHILE • SALES OFFICE

Santiago • 56.9.9917.3920

OTHER OMRON LATIN AMERICA SALES

54.11.4783.5300

OMRON EUROPE B.V. • Wegalaan 67-69, NL-2132 JD, Hoofddorp, The Netherlands. • +31 (0) 23 568 13 00 • www.industrial.omron.eu

Authorized Distributor:

Automation Control Systems

- Machine Automation Controllers (MAC) • Programmable Controllers (PLC)
- Operator interfaces (HMI) • Distributed I/O • Software

Drives & Motion Controls

- Servo & AC Drives • Motion Controllers & Encoders

Temperature & Process Controllers

- Single and Multi-loop Controllers

Sensors & Vision

- Proximity Sensors • Photoelectric Sensors • Fiber-Optic Sensors
- Amplified Photomicrosensors • Measurement Sensors
- Ultrasonic Sensors • Vision Sensors

Industrial Components

- RFID/Code Readers • Relays • Pushbuttons & Indicators
- Limit and Basic Switches • Timers • Counters • Metering Devices
- Power Supplies

Safety

- Laser Scanners • Safety Mats • Edges and Bumpers • Programmable Safety Controllers • Light Curtains • Safety Relays • Safety Interlock Switches

X-ON Electronics

Largest Supplier of Electrical and Electronic Components

Click to view similar products for [UPS - Uninterruptible Power Supplies](#) category:

Click to view products by [Omron](#) manufacturer:

Other Similar products are found below :

[BAT-LI-2S2P3000-R10](#) [SMART-1400-RM](#) [UPS1500ITSIT](#) [UPS12438](#) [UPS12434](#) [UPS25512](#) [UPS1024746](#) [UPS23916EBM](#) [UPSITSNMP](#)
[UPS1024747](#) [CBI2801224A](#) [AKKUTEC2402](#) [AKKUTEC2405](#) [CBI-RTCONN3](#) [QUINT4-UPS/1AC/1AC/1KVA](#) [AKKUTEC2440](#)
[SLNSPSPMBRK](#) [AUPS-B10-R20](#) [INTERNET650U1](#) [BC500](#) [1081430](#) [1082548](#) [SMART 2200NET](#) [SDU500A-5](#) [SDU500A](#) [LDX-U20](#)
[SDUCFRELAYCARD](#) [SDU-24-BAT](#) [AP9631](#) [BCPRO600](#) [SPUBC24120](#) [SPUC24720](#) [DRU-24V10ACZ](#) [DRU-24V40ABN](#) [DR-UPS40](#)
[ECO550UPS](#) [SC620](#) [S8BA-24D24D120LF](#) [S8BA-24D24D240LF](#) [UPS003LSM](#) [1094596](#) [1100666](#) [2320212](#) [2320225](#) [2320238](#) [2320241](#)
[2320254](#) [2320267](#) [2320270](#) [2320377](#)