

LAN Magnetics Solution for 1000BASE-T

Evaluation Board TDK Part number: ALT4532-EVA-01

Contents

- PCB area reduction from typical module to discrete placement

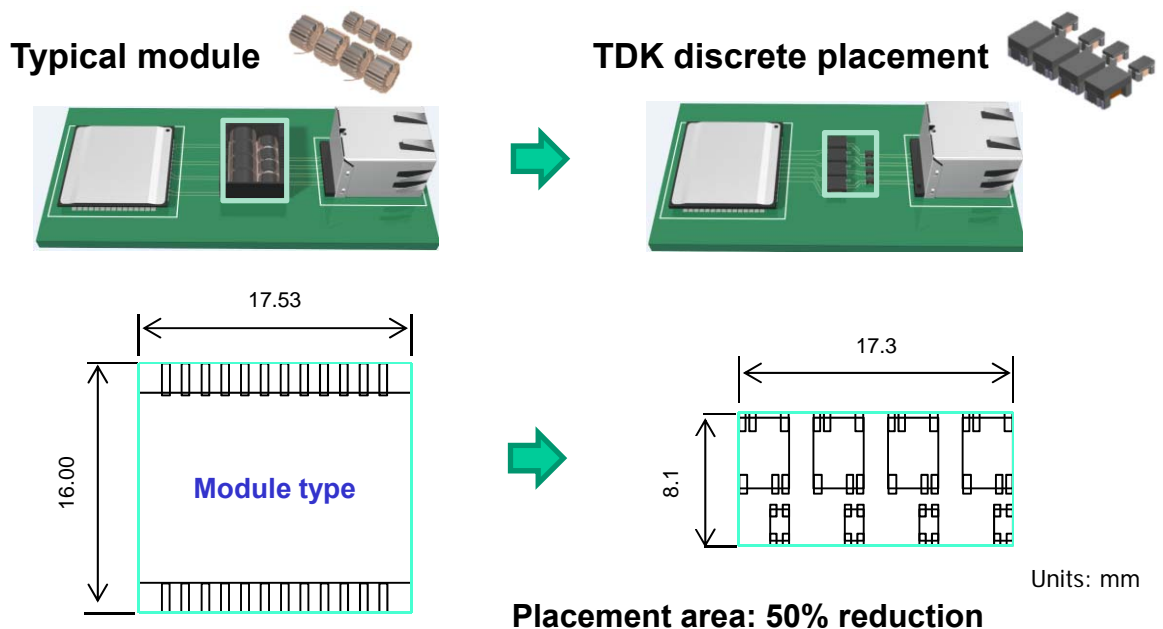

- Evaluation Board configuration and detailed specification

- Technical Specification of Pulse Transformer plus Common Mode Filter combination for 1000BASE-T Solution

- LAN Transformer: ALT4532M-201-T001
- Common Mode Filter: ACM2012E-900-2P-T00

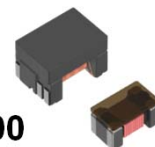

Disclosure:

- Evaluation Board is provided for evaluation of TDK discrete solution purposes only. Customer needs to implement connections into its PCB lay out design for mass production.
- Evaluation Board will be replaced if a working problem is found, without failure analysis.

Evaluation board – Ordering Part Number: ALT4532-EVA-01

- Contains ALT4532M-201-T001 + ACM2012E-900-2P-T00 solution for quick evaluation
- Allows SI/EMC test for our ALT4532 on the same land pattern as module

1000BASE-T Evaluation Board (Offers equivalent layout to Module type)

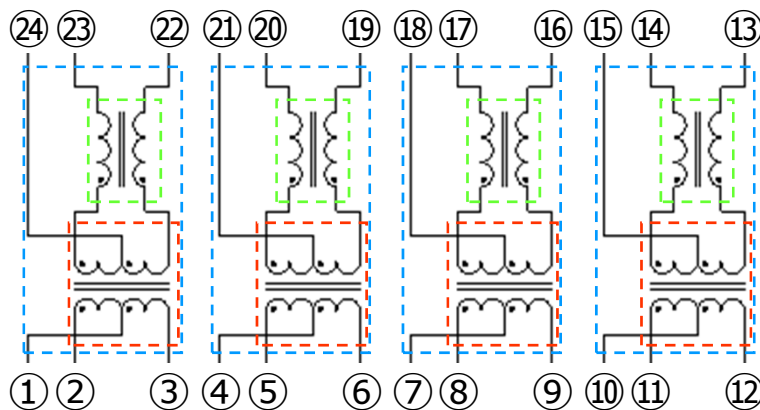
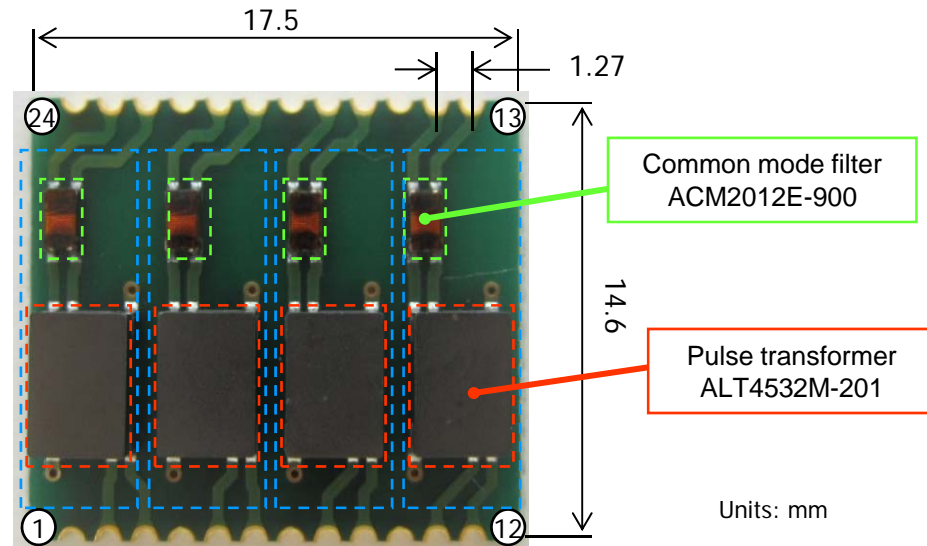

Evaluation Board Electrical diagram and pint out

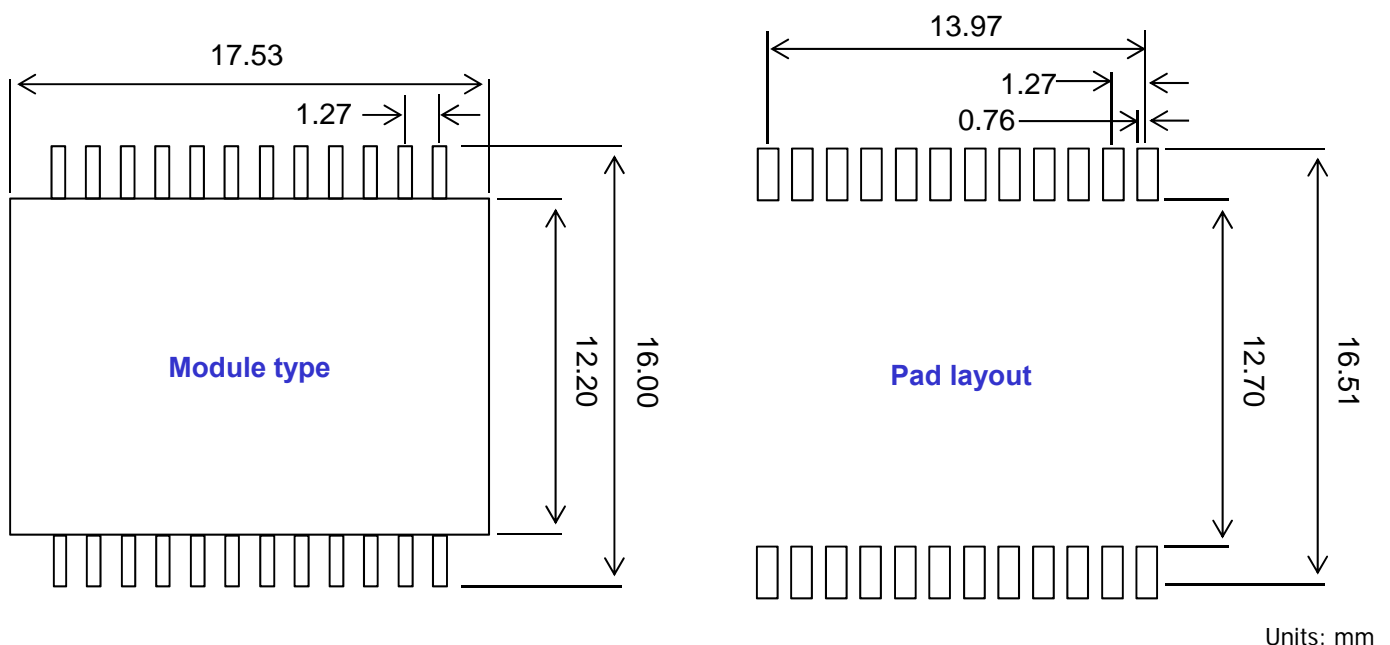

Overview of ALT4532M-201-T001



FEATURES

- The ALT Series contains wound chip type pulse transformers developed for LANs.
- Compatible with 10BASE-T, 100BASE-TX, and 1000BASE-T.
- High-quality product that uses auto winding.
- Conforms to the RoHS Directive.

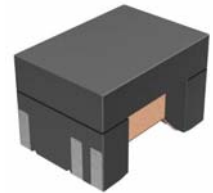

GENERAL SPECIFICATIONS

SHAPE & DIMENSIONS

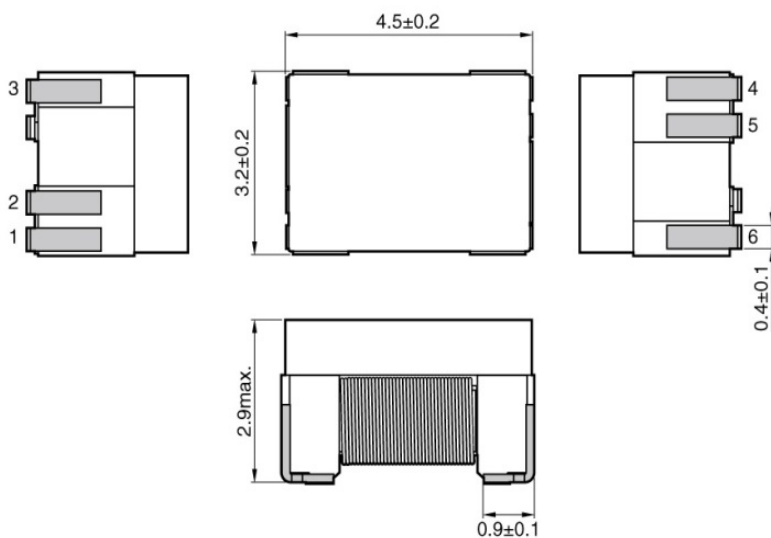

Dimensions in mm

CIRCUIT DIAGRAM

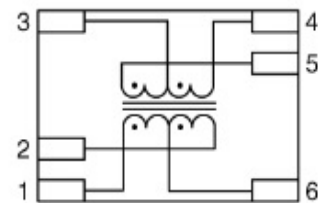

RECOMMENDED LAND PATTERN

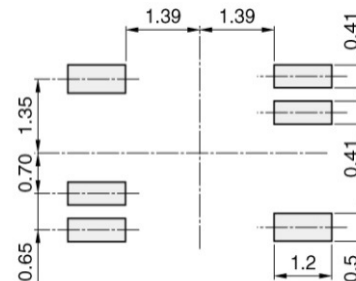

ELECTRICAL CHARACTERISTICS

CHARACTERISTICS SPECIFICATION TABLE

Turns ratio	Inductance [DC bias 8mA, 100kHz]	Insertion loss [0.1 to 100MHz]	Inter-winding stray capacitance [100kHz]	Part No.
①⑥② : ⑤③④	①-② ⑤-④ (μH)min.	①②-⑤④ (dB)max.	(pF)max.	
1CT : 1CT	200	1.5	35	ALT4532M-201-T001

OPERATING TEMPERATURE RANGE

Type	Temperature range	
	Operating temperature* (°C)	Storage temperature** (°C)
ALT4532M-201	-40 to +85	-40 to +85

* Operating temperature range includes self-temperature rise.

** The Storage temperature range is for after the circuit board is mounted.

FEATURES

- Downsized, low height wound type chip common mode filter that maintains required common mode filter characteristics.
- Impedance for common mode noise can clear 1000Ω [100MHz], and has excellent EMC suppression.
- Differential mode impedance is suppressed, so there is virtually no affect on high speed signals.
- Conforms to the RoHS Directive.

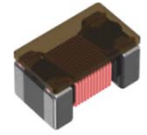

GENERAL SPECIFICATIONS

SHAPE & DIMENSIONS

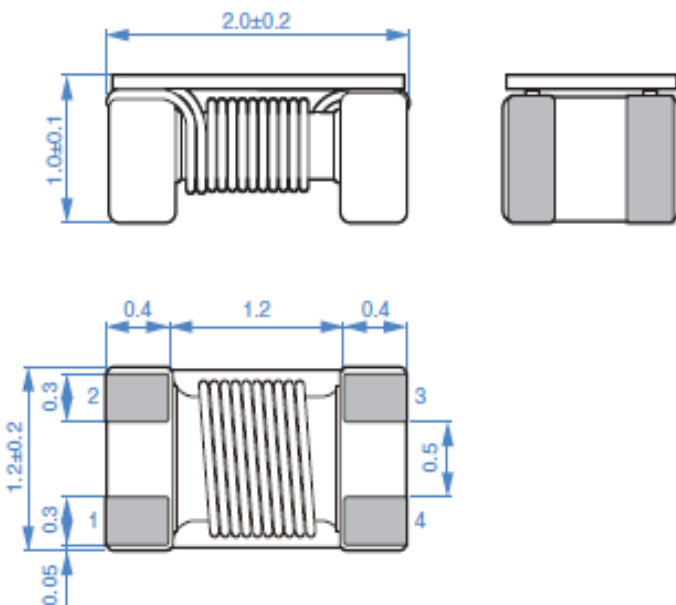

CIRCUIT DIAGRAM

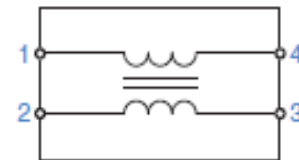

RECOMMENDED LAND PATTERN

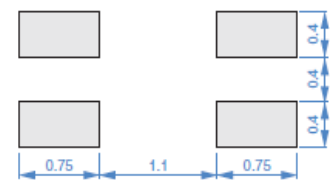

Dimensions in mm

ELECTRICAL CHARACTERISTICS

CHARACTERISTICS SPECIFICATION TABLE

Impedance [100MHz] (Ω)	DC resistance [1 line] (Ω)max.	Rated voltage (V)max.	Insulation resistance (MΩ)min.	Rated current (A)max.	Part No.
90±25%	0.35	50	10	0.33	ACM2012E-900-2P-T00

OPERATING TEMPERATURE RANGE

Type	Temperature range	
	Operating temperature (°C)	Storage temperature* (°C)
ACM2012E-900-2P-T00	-40 to +85	-40 to +85

* The Storage temperature range is for after the circuit board is mounted.

Comparison between TDK Solution and Conventional module for Balance Parameter

** TDK solution offers excellent frequency performance.

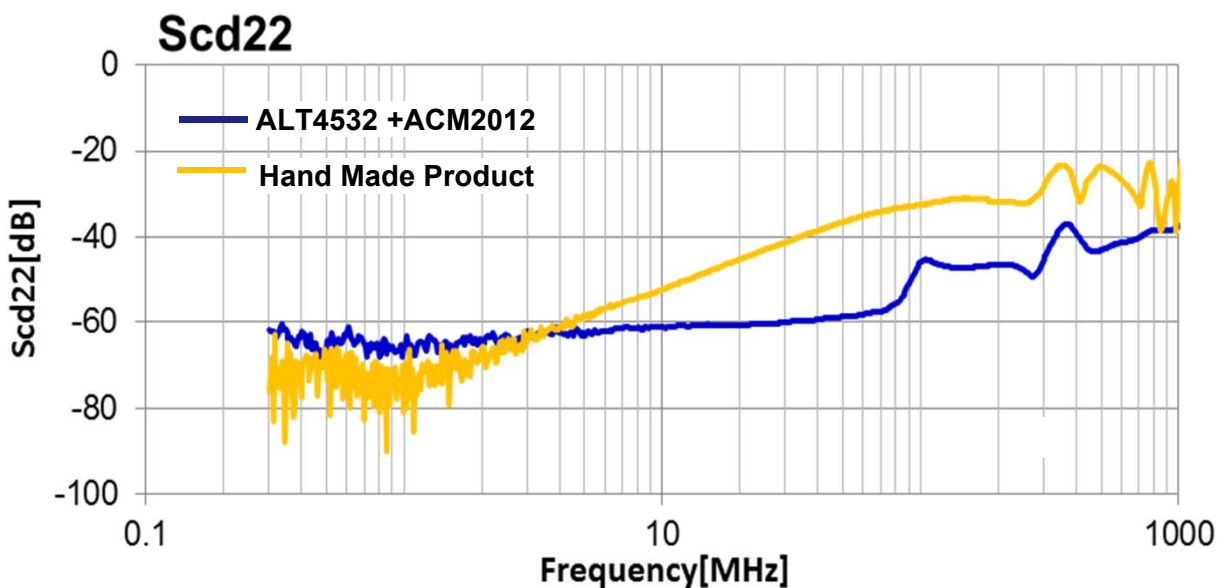
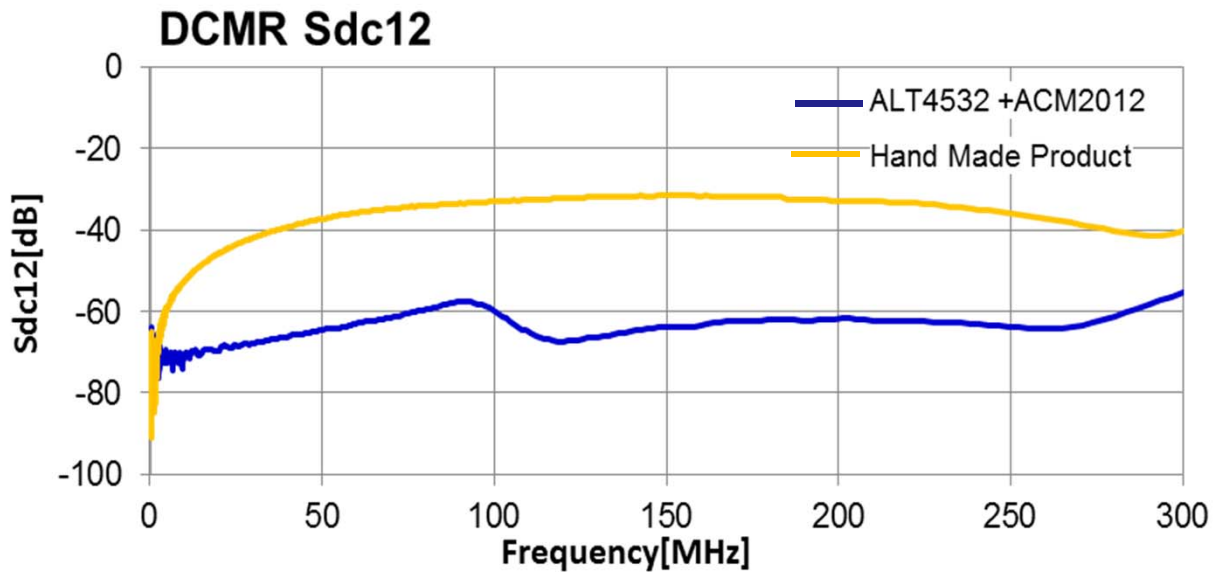

ALY4532



ACM2012



+

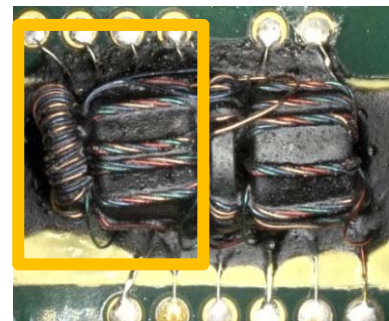

Full Automation

vs

Hand Made Product

For any additional inquiries, You can contact the following locations

US-West

PIC: David Sanchez

E-mail: david.sanchez@us.tdk.com

TDK Corporation of America
Product Marketing and Development Dept.
1740 Technology Drive, Suite 110, San Jose, CA 95110
Phone#: +1-(408) 437-9585

US-East

PIC: Rafael Perez Magana

E-mail: rafael.perez_magana@us.tdk.com

TDK Corporation of America
475 Half Day Road
Lincolnshire, IL. 60069
Tel: +1(847)390-4385
E-mail: rafael.perez_magana@us.tdk.com

Europe

PIC: Samuel Rios Mesa

E-mail: Samuel.RiosMesa@eu.tdk.com

TDK Europe GmbH
Rosenheimer Str. 116B, 81669 Munich, Germany
Telephone: +49-(0)89 54020 3223
mailto:Samuel.RiosMesa@eu.tdk.com

Taiwan

PIC: Andy Tseng

E-mail: Andy_Tseng@tw.tdk.com

TDK Taiwan Corporation
Sales promotion Dept.
7th Floor, #66 San Chong Road Nangang District,
Taipei City Taiwan (R.O.C.) 11560
Phone#: +886-2-278 91117

Japan

PIC: Yuetsu Watanabe

E-mail: nabenabe@jp.tdk.com

TDK Corporation
Sales promotion Dept.
3-9-1, Shibaura, Minato-ku, Tokyo
Phone#: +81-3-5201-7229

China(Shenzhen)

PIC: Elena Kuang

E-mail: elena.kuang@cn.tdk.com

TDK Shenzhen Branch Office
Product Marketing Dept.
69/F, Ping An Financial Centre 5033 Yitian Road, Futian District,
Shenzhen 518048 PR CHINA
Phone#: +86-755-830 54666

China(Shanghai)

PIC: Ken Xu

E-mail: ken.xu@cn.tdk.com

TDK (SHANGHAI) INTERNATIONAL TRADING CO.,LTD
Product Marketing Dept.
Room 3201, Shanghai International Trade Centre 2201,
Yan An Rd(W), Changning District, Shanghai
Phone#: +86-21-619 62416

Singapore

PIC: Yuichi Hagiwara

E-mail: Y.Hagiwara@sg.tdk.com

TDK Singapore (PTE) LTD.
11 North Bouna Vista Drive #13-08
The Metropolis Tower 2 Singapore 138589
Phone#: +65-6273-5022

Korea

PIC: Kyung-Hwan Hwang

E-mail: kyunghwan_hwang@kr.tdk.com

Korea TDK Co., LTD
Product Marketing Dept.
1st FL II-HEUNG BLDG. 1490-25 SOCHO-DONG, SEOCHO-GU
SEOUL 137-070
Phone#: +82-2-3019-4335

X-ON Electronics

Largest Supplier of Electrical and Electronic Components

Click to view similar products for [Ethernet Development Tools](#) category:

Click to view products by [TDK](#) manufacturer:

Other Similar products are found below :

[KSZ8852HLEYA](#) [TDKEZW5-DEV](#) [XAUI-RISER-B](#) [DP83848H-MAU-EK](#) [ZENETSC0100ZACG](#) [XTIB-E](#) [EVB-LAN9218I-MINI](#)
[KSZ8081MNX-EVAL](#) [KSZ8081RNB-EVAL](#) [KSZ8091RNB-EVAL](#) [KSZ8852HLE-EVAL](#) [KSZ8863FLL-EVAL](#) [KSZ8873MLL-EVAL](#) [2971](#)
[TDKEZW3-DEV](#) [PD70201EVB47F](#) [KSZ8895MQX-EVAL](#) [PD70201EVB47](#) [PD-IM-7648M](#) [PD-IM-7648T4](#) [PD-IM-7604-4MH](#)
[EV09H26A](#) [EV44F42A](#) [PD-IM-7618T4H](#) [PD-IM-7618T4](#) [EVAL-ADIN1300FMCZ](#) [EVAL-ADIN1200FMCZ](#) [KIT-A1006-SHIELD](#)
[VSC8258EV](#) [VSC8211EV](#) [VSC8584EV](#) [VSC8574EV](#) [EV16T60A](#) [ioShield_A](#) [DP83620-EVK/NOPB](#) [STEVAL-TDE001V1](#) [STEVAL-](#)
[PCC010V1](#) [EVB9512](#) [DP83848T-MAU-EK](#) [DP83848I-POE-EK](#) [DP83848K-MAU-EK](#) [DP83848I-MAU-EK/NOPB](#) [KSZ8041NL-EVAL](#)
[KSZ8091RNA-EVAL](#) [KSZ8999-EVAL](#) [KSZ8031RNL-EVAL](#) [KSZ8051MLL-EVAL](#) [KSZ8842-16MQL-EVAL](#) [WIZ550S2E-232-EVB](#)
[ALT4532-EVA-01](#)