2.4 GHz / 5.5 GHz Waterproof Dipole 2 dBi Antenna, IP67



ORDERING INFORMATION

Order Number	Description
001-0012	2.4/5.5 GHz Waterproof Dipole Antenna for Reverse Polarity SMA Connector, IP67
080-0013	U.FL to Reverse Polarity SMA Cable, 105mm, O-Ring Seal
080-0014	U.FL to Reverse Polarity SMA Cable, 210mm, O-Ring Seal

Table 1 Orderable Part Numbers

SPECIFICATIONS

Specification	Value
2.4 Ghz Band Gain	+2 dBi
5 GHz Band Gain	+2 dBi
Impedance	50 ohms
Type	Dipole
Polarization	Linear Vertical
VSWR	≤2.5 : 1
Frequency	2400 - 2500MHz, 4910 - 5850MHz
Weight	18g
Size	114 mm × 13 mm
Antenna Color	Black
Operating Temp	-40°C to +85°C
UL Rating	UL 94HB

Table 2 Specifications

PHYSICAL DIMENSIONS (MM)

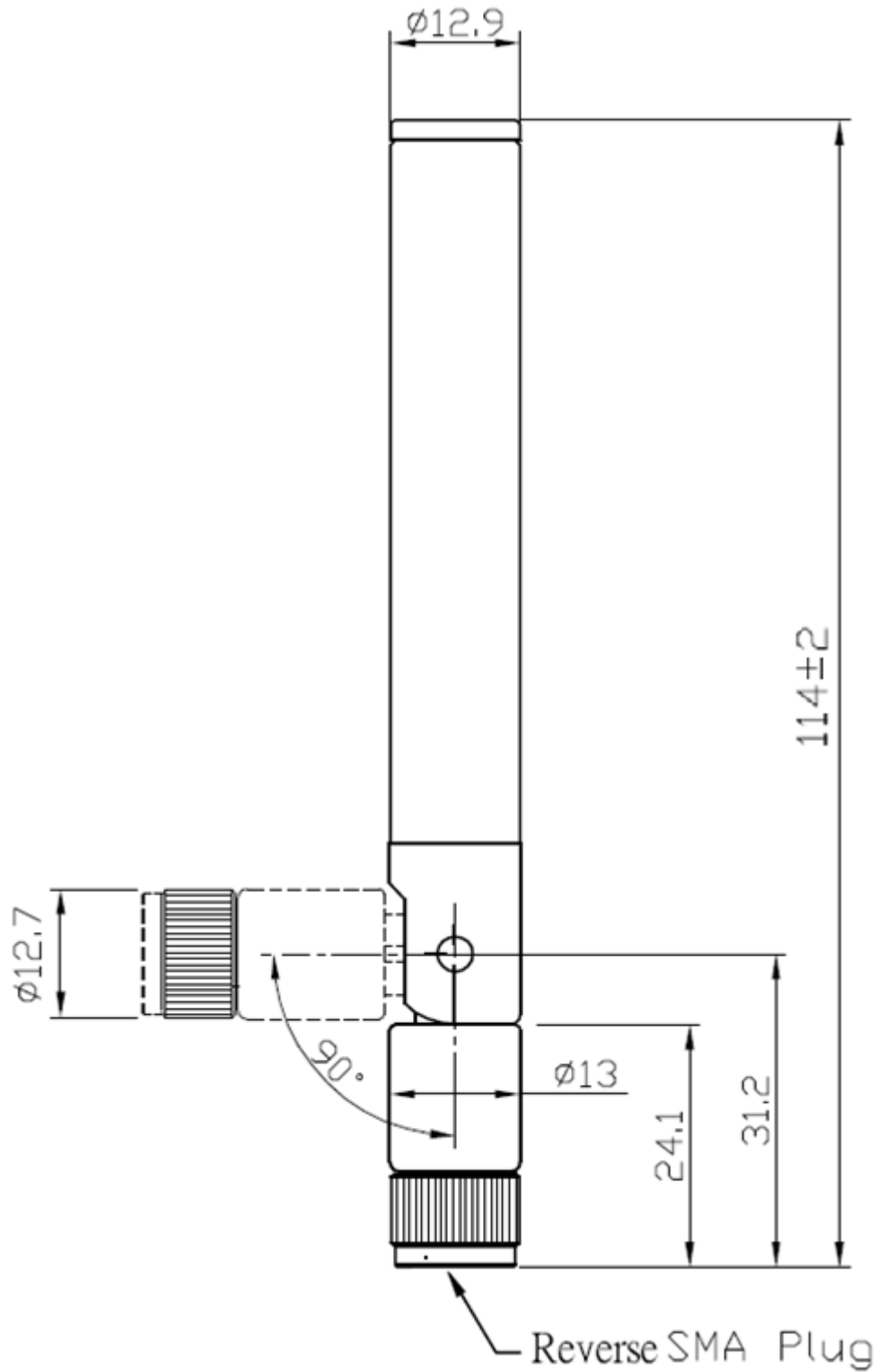

Figure 1 Physical Dimensions

TYPICAL ANTENNA REFLECTION PERFORMANCE

Straight Antenna Position

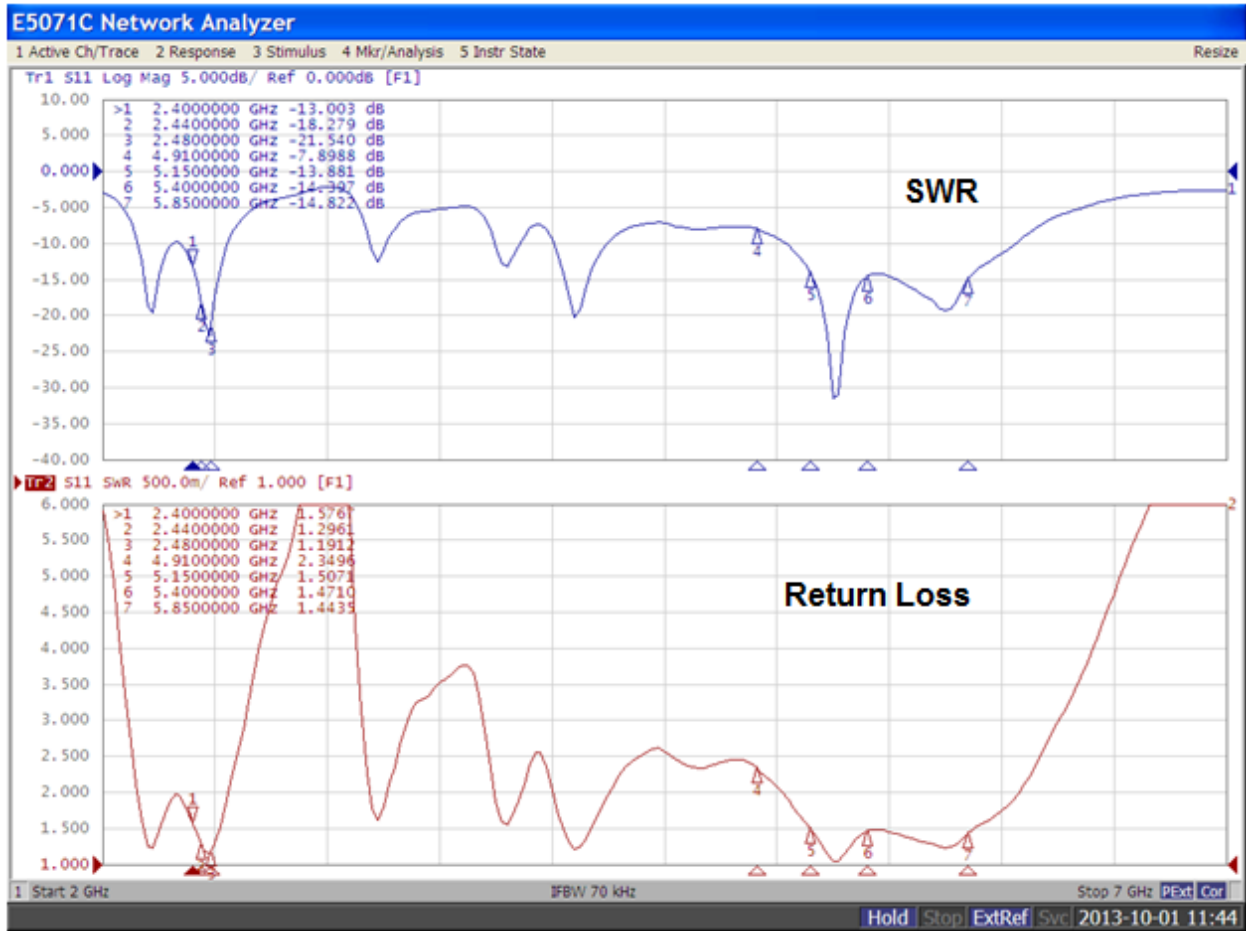

Figure 2 Typical Straight Position Reflection Performance

Bent Antenna Position

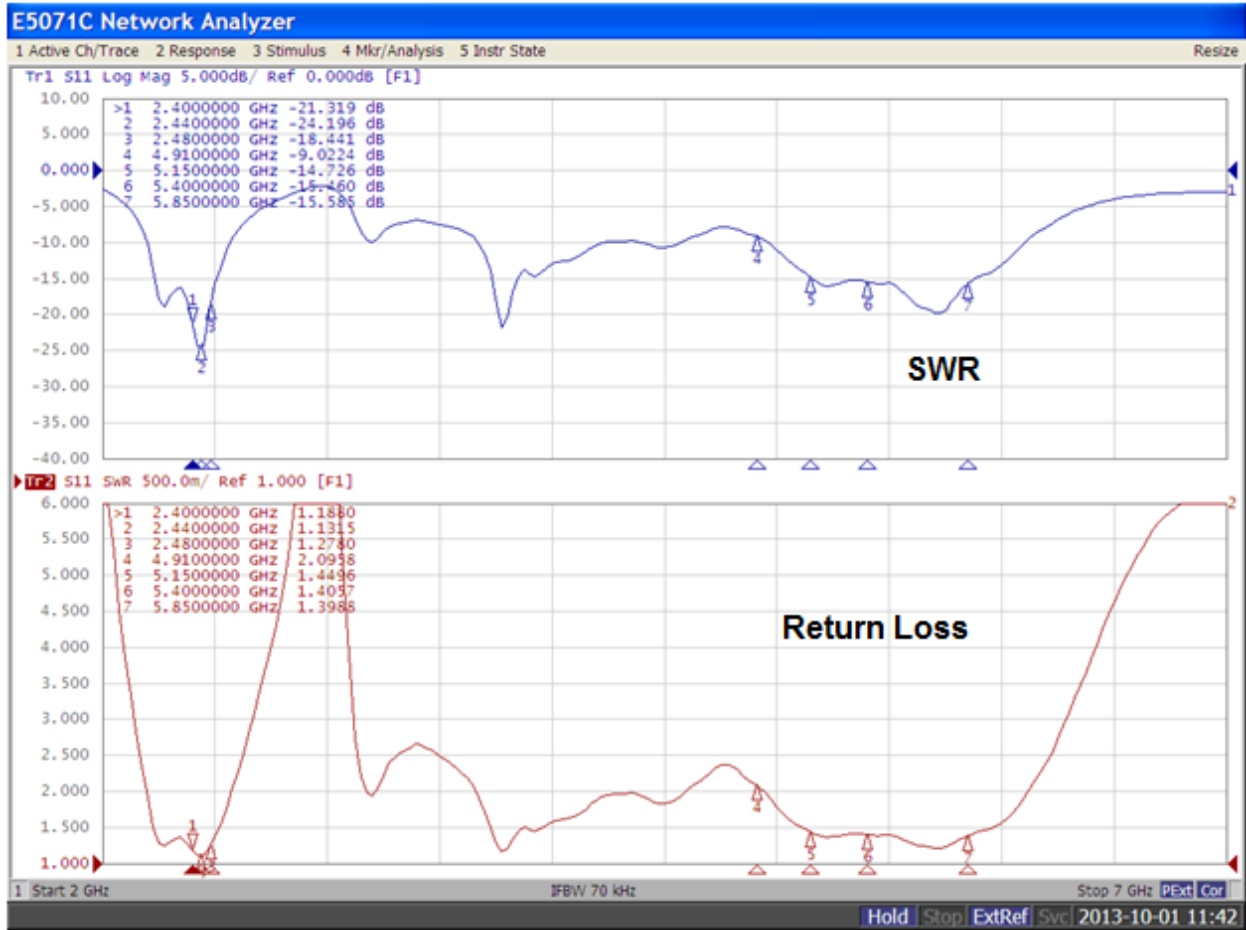

Figure 3 Typical Bent Position Reflection Performance

TYPICAL ANTENNA RADIATION PERFORMANCE

2.4 GHz Band

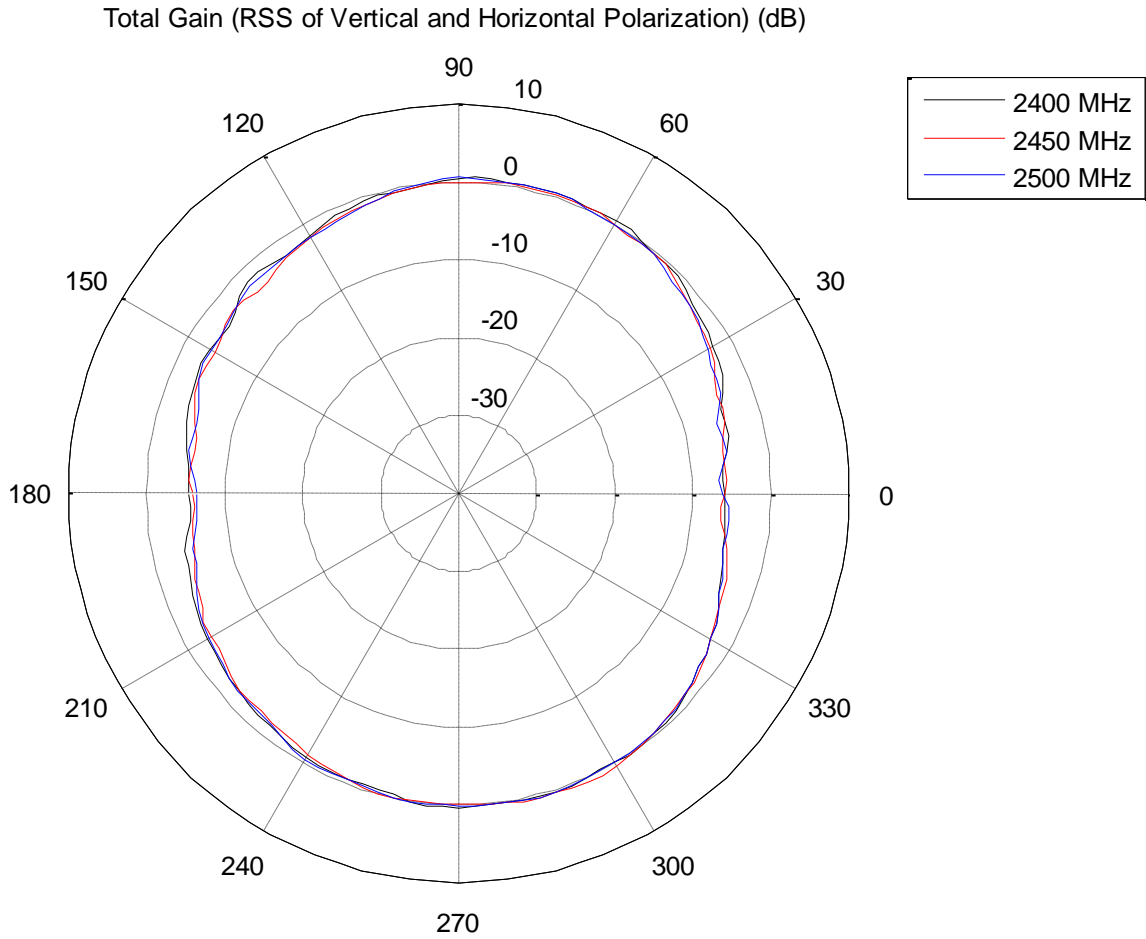

Figure 4 Typical E-Plane Performance

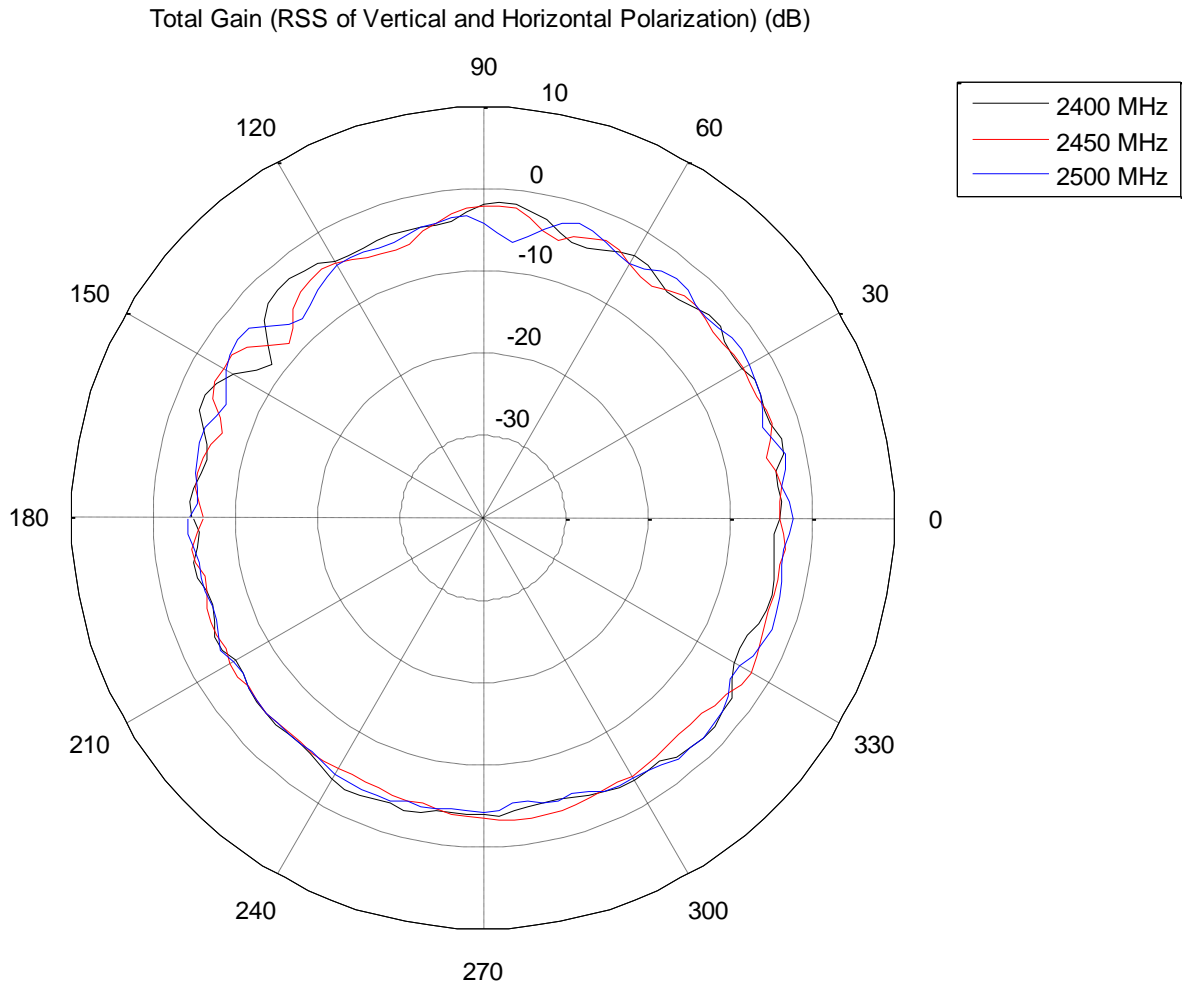

Figure 5 Typical H-Plane Performance

5 GHz Band

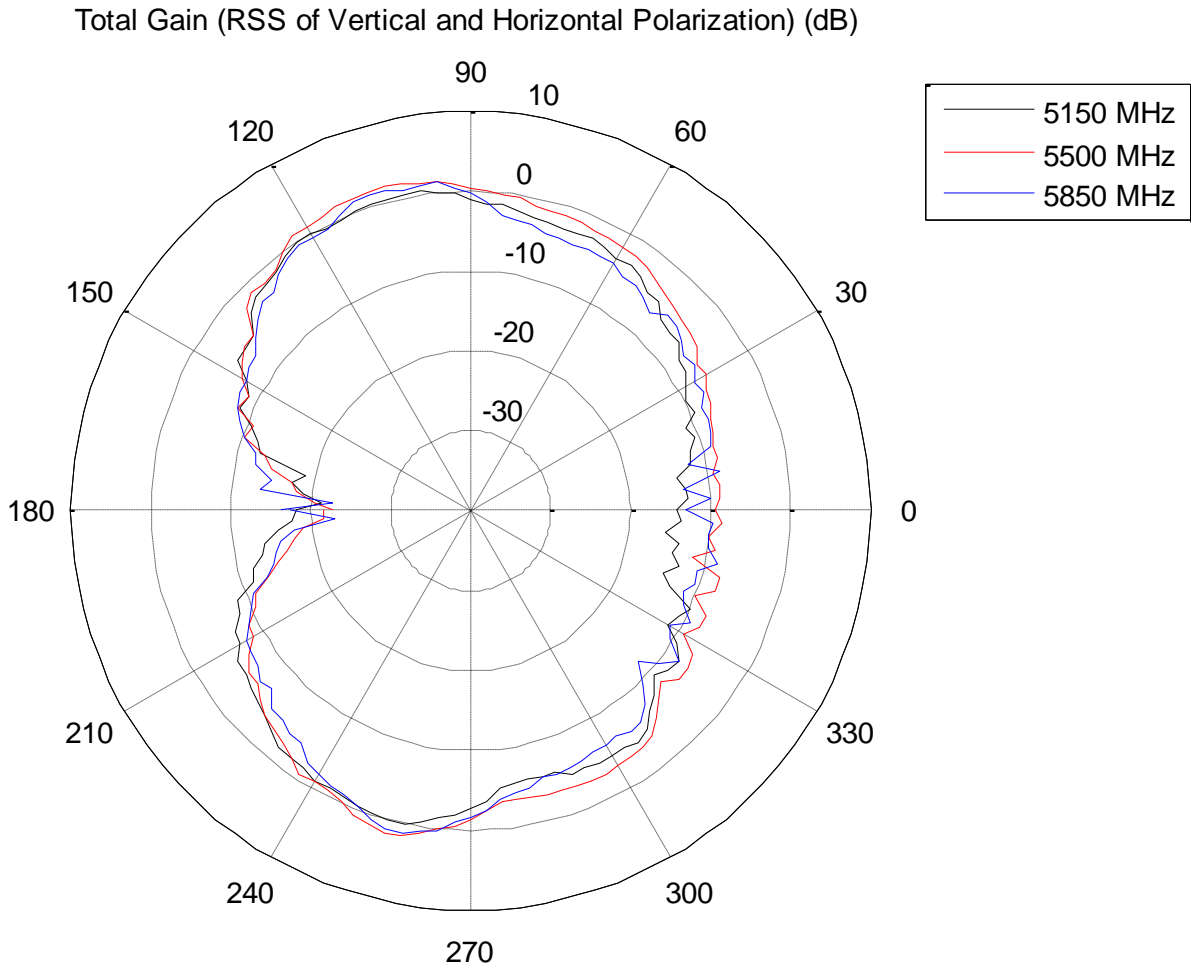

Figure 6 Typical E-Plane Performance

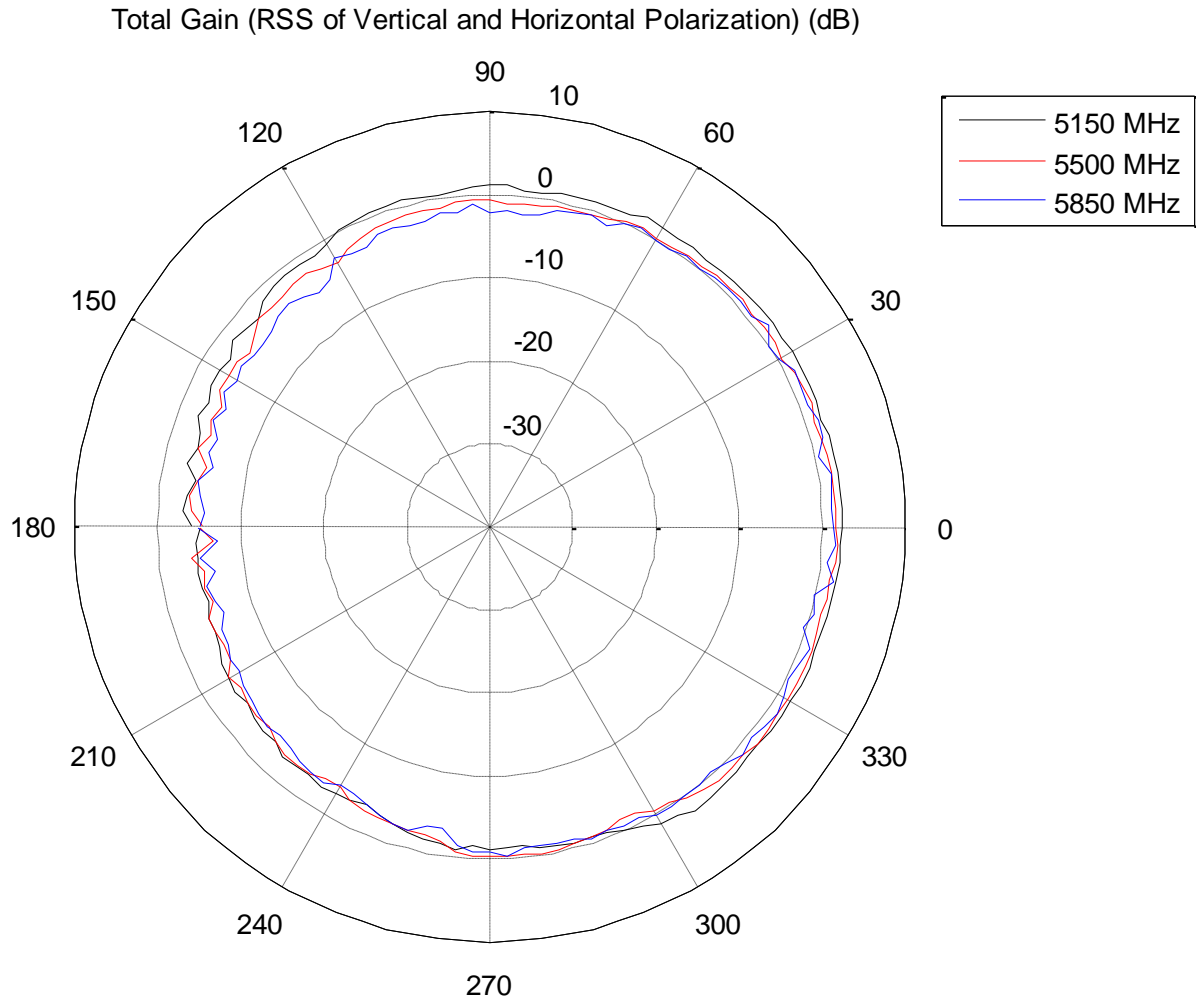

Figure 7 Typical H-Plane Performance

CONTACTING LS RESEARCH

Headquarters	LS Research, LLC W66 N220 Commerce Court Cedarburg, WI 53012-2636 USA Tel: 1(262) 375-4400 Fax: 1(262) 375-4248
Website	www.lsr.com
Wiki	www.lsr.com/products-wiki
Technical Support	www.lsr.com/products-forum
Sales Contact	sales@lsr.com

© Copyright 2018 Laird. All Rights Reserved. Patent pending. Any information furnished by Laird and its agents is believed to be accurate and reliable. All specifications are subject to change without notice. Responsibility for the use and application of Laird materials or products rests with the end user since Laird and its agents cannot be aware of all potential uses. Laird makes no warranties as to non-infringement nor as to the fitness, merchantability, or sustainability of any Laird materials or products for any specific or general uses. Laird, Laird Technologies, Inc., or any of its affiliates or agents shall not be liable for incidental or consequential damages of any kind. All Laird products are sold pursuant to the Laird Terms and Conditions of Sale in effect from time to time, a copy of which will be furnished upon request. When used as a tradename herein, Laird means Laird Limited due to the acquisition by Advent or one or more subsidiaries of Laird Limited. Laird™, Laird Technologies™, corresponding logos, and other marks are trademarks or registered trademarks of Laird. Other marks may be the property of third parties. Nothing herein provides a license under any Laird or any third party intellectual property right.

The information in this document is subject to change without notice.

X-ON Electronics

Largest Supplier of Electrical and Electronic Components

Click to view similar products for [Antennas](#) category:

Click to view products by [Laird Connectivity](#) manufacturer:

Other Similar products are found below :

[CCT FM1](#) [ABFT](#) [AD-NM-SMAF 001-0021](#) [CTC110](#) [MAF94149](#) [EXE902SF](#) [MMCX-SMA-100](#) [PDQ24496-91NF](#) [GAN30084EU](#) [930-033-R](#) [A08-HABUF-P5I](#) [AAF95035](#) [DG-ANT-20DP-BG-B](#) [APAMPGJ-141](#) [1513563-1](#) [OF86315-FNF](#) [OP24516DS-91NM](#) [A09-HASM-7](#) [EXE902MD](#) [EXE902SM](#) [SPDA17806/2170LAR](#) [APAMPG-117](#) [GPS1575SP26-004](#) [GPS15MGSMA](#) [CMD69273P-30NF](#) [CMQ69273-30NF](#) [RD2458-5-OTDR-NM](#) [RD2458-5-RSMA](#) [TRAB24/49003](#) [W4120ER5000](#) [W6102B0100](#) [YE572113-30RSMM](#) [108-00014-50](#) [SPDA17RP918](#) [OP24516SX-91NM](#) [OP24516SX-91RSMM](#) [CMQ69273P-30NF](#) [CMS69273-30NF](#) [CMS69273P-30NF](#) [TRAB24003N](#) [TRAB24003NP](#) [TRAB8213NP](#) [TRAB8903](#) [A09-Y8NF](#) [A09-Y11NF](#) [A09-HSM-7](#) [A09-F8NF-M](#) [A09-F5NF-M](#)