

ORDERING INFORMATION

Tooling

Part Number	Description
1387G3	Hydraulic tool for power contacts
E160-36	Extraction tool

Note: For tooling die information, see tooling chart on website.

DIMENSIONS

Pin Contact

Part Number	- Wire -		- ØA -		- ØB -	
	mm ²	AWG	mm	in.	mm	in.
160-1116	16	#6	8.4	0.33	6.0	0.24
160-1125	25	#4	11.0	0.43	8.0	0.31
160-1135	35	#2	12.5	0.49	9.0	0.35
160-1150	50	#1/0	14.5	0.57	11.0	0.43

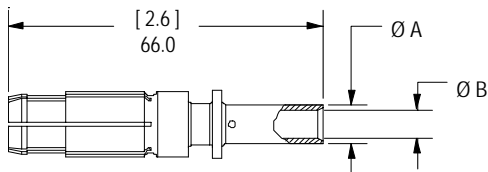

Upper Auxiliary Contact

E160-33 upper auxiliary contact for 4 mm² (#12 AWG)

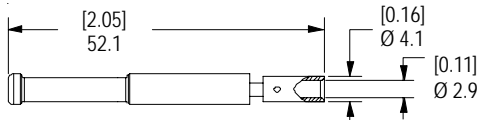

Lower Auxiliary Contact

160-13 lower auxiliary contact for 6 mm² (#10 AWG)

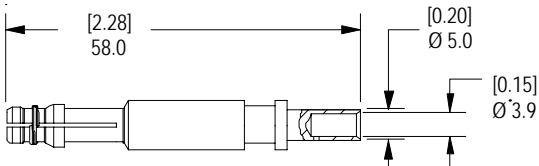

Handle / Lever Assembly / Latch

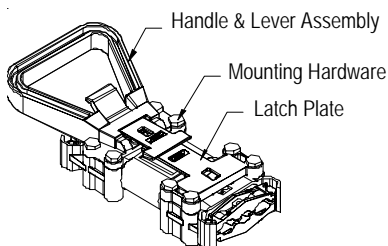

Housing Front View

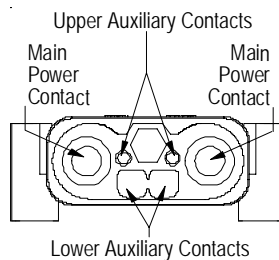

Housing Side View

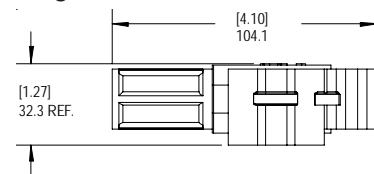

Housing Top View

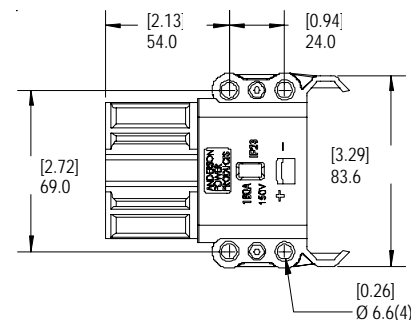

TEMPERATURE CHARTS

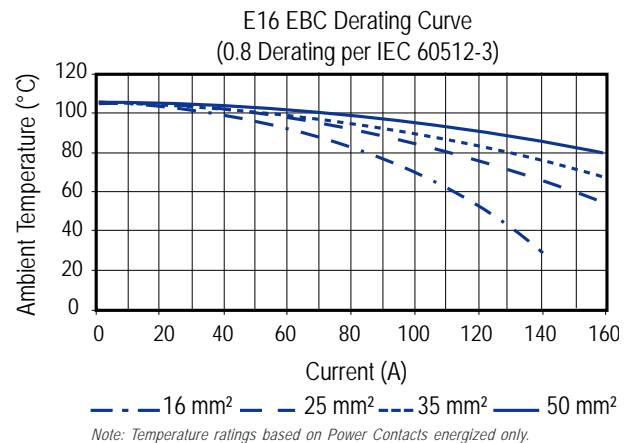
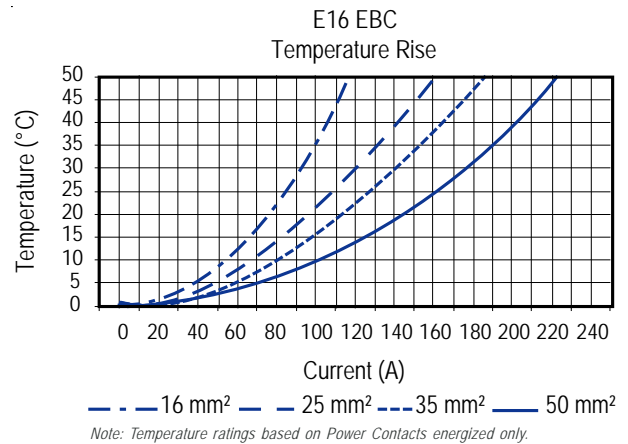

X-ON Electronics

Largest Supplier of Electrical and Electronic Components

Click to view similar products for [Heavy Duty Power Connectors](#) category:

Click to view products by [Anderson Power Products](#) manufacturer:

Other Similar products are found below :

[1424439](#) [1424438](#) [09330062652](#) [2-8675P1](#) [605601-1](#) [6340G1](#) [6341G1](#) [6360G1](#) [6373G1](#) [6374g2](#) [6396G1](#) [647757-1](#) [66394-4](#) [6643411-1](#)
[6646058-2](#) [6646137-1](#) [6646138-1](#) [6646348-1](#) [6646479-1](#) [6646608-1](#) [6646786-1](#) [6646940-1](#) [6651091-1](#) [6651525-1](#) [6651529-1](#) [6651778-1](#)
[6651788-1](#) [696465-1](#) [696475-1](#) [73000005059](#) [73000005349](#) [73000005642](#) [73080255059](#) [73080965046](#) [765-15-0080A](#) [765-16-0080B](#)
[789.700-44](#) [789.700-54](#) [80-1010](#) [80-9](#) [827381-1](#) [829992-1](#) [902-77-02113](#) [PL00U-301-10D10](#) [PM103MOOLOO](#) [PM16S1620S32-50](#)
[PM212MOOLOO](#) [PM309FOOLOO](#) [PM324FOOLCH](#) [PMHPAF11S03](#)