

CD CRIMP TYPE CONNECTOR

General

The model CD connectors are SM Series (sub-miniature) rectangular multi-contact crimping connectors. CD Crimp Type Connectors are Crimp Type D Sub-miniature Connectors for Discrete Wire Terminations.

Available in 9, 15, 25 and 37 way. Terminals available for AWG28 through AWG20. Plug with Grounding dimples is introduced now.

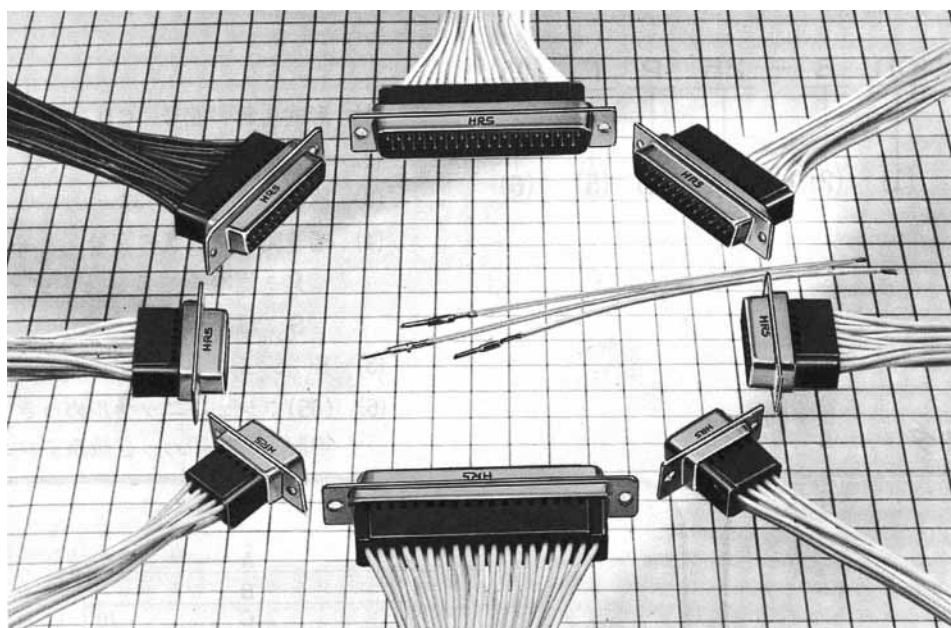

Features

- (1) Compact and sturdy due to metal shell.
- (2) Can be mounted on the front or back of a panel or chassis as necessary.
- (3) Requires no special withdrawal jig (push the retainers from the connector sides to insert/withdraw the connector).
- (4) Uses insulation made from highly heat-resistant and chemical-resistant UL synthetic resin.

Application

Suitable for modems in communications equipment such as computers, peripherals and terminals, control equipment, measuring instruments, and export equipment.

Electrical and Environmental

Electrical and Environmental Characteristics	
Current capacity	3A
Rated voltage	350V AC
Insulation resistance	5000mΩ min. at 500V DC
Contact resistance	25mΩ max. at 100mA DC
Withstand voltage	1250Vrms AC for 1 minute

Material and finish		
Shell	Steel	Nickel plating
Insulator	PBT (GE Valox)*	Black
Contacts	Phosphor bronze	Nickel plating + Gold plating

*UL94V-0

Connector Housing

C D B — 25 P F (05)
 (1) (2) (3) (4) (5) (6)

- (1) Series Name CD: Crimping type
- (2) Shell Size E.A.B.C.
- (3) No. of Pin 9, 15, 25, 37
- (4) Type of Housing
 P: Plug Housing
 S: Receptance Housing
- (5) Type of Shell
 F: With Grounding dimples
- (6) Specification contents
 (05): Nickel plated shell

Male Connector



CDB-25P (05)

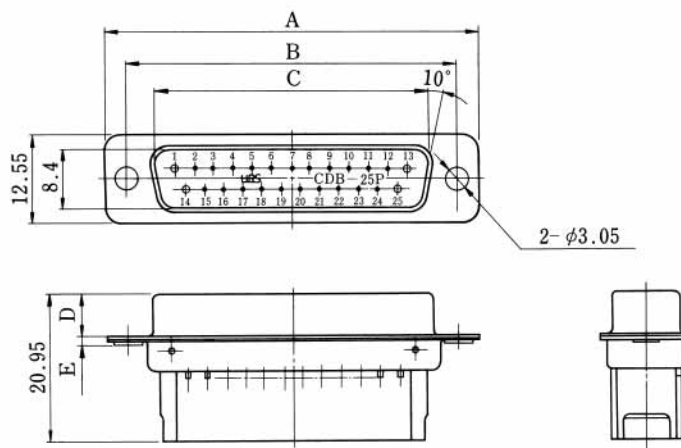

Unit: mm

HRS No	No. of pin	Part No.	A	B	C	D	E	RoHS
CL211-0186-0-05	9	CDE-9P (05)	30.81	24.99	16.9	5.99	1.2	YES
CL211-0279-0-05	15	CDA-15P (05)	39.14	33.32	25.24	5.99	1.2	
CL211-0211-6-05	25	CDB-25P (05)	53.04	47.04	39.01	5.87	1.3	
CL211-0281-1-05	37	CDC-37P (05)	69.32	63.5	55.47	5.87	1.4	

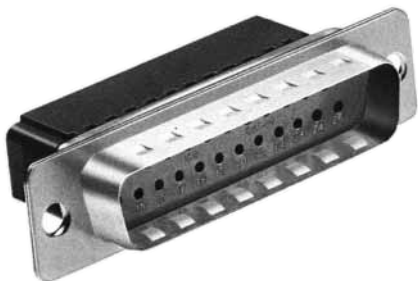

CDB-25PF (05)

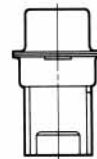
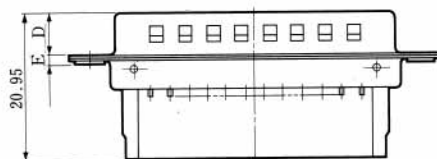
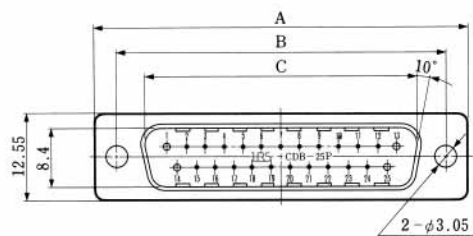

Unit: mm

HRS No	No of pin	Part No.	A	B	C	D	E	RoHS
CL211-0600-8-05	9	CDE-9PF (05)	30.81	24.99	16.9	5.99	1.2	YES
CL211-0601-0-05	15	CDA-15PF (05)	39.14	33.32	25.24			
CL211-0602-3-05	25	CDB-25PF (05)	53.04	47.04	39.01	5.87		
CL211-0603-6-05	37	CDC-37PF (05)	69.32	63.5	55.47	1.4		

Female Connector



CDB-25S (05)

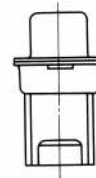
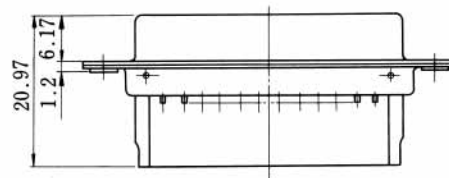
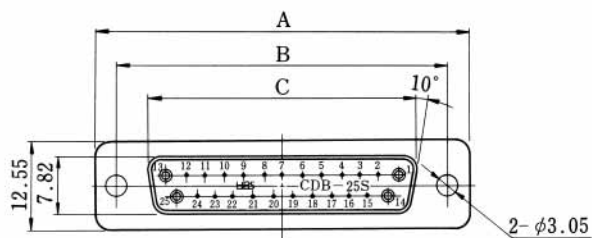

Unit: mm

HRS No	No of pin	Part No.	A	B	C	RoHS
CL211-0207-9-05	9	CDE-9S (05)	30.81	24.99	16.4	YES
CL211-0280-9-05	15	CDA-15S (05)	39.14	33.32	24.59	
CL211-0212-9-05	25	CDB-25S (05)	53.04	47.04	38.3	
CL211-0282-4-05	37	CDC-37S (05)	69.32	63.5	54.76	

Contact

Male Contact

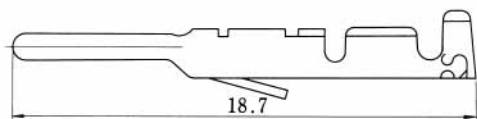

種類	HRS No	Part No.	Applicable wire	RoHS
Loose contact	CL211-0185-8	CD-PC-111	AWG#20~24	YES
Chain contact	CL211-0202-5	CD-PC-121	AWG#24~28	
Chain contact	CL211-0200-0	CD-PC-211	AWG#20~24	YES
	CL211-0201-2	CD-PC-221	AWG#24~28	

Female Contact

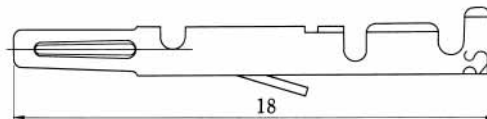

種類	HRS No	Part No.	Applicable wire	RoHS
Loose contact	CL211-0205-3	CD-SC-111	AWG#20~24	YES
Chain contact	CL211-0206-6	CD-SC-121	AWG#24~28	
Chain contact	CL211-0203-8	CD-SC-211	AWG#20~24	YES
	CL211-0204-0	CD-SC-221	AWG#24~28	

Note : Loose-Piece terminals are available in Packs. Each Pack contains 100 terminals. Strip terminals are available in reels. Each contains 10,000 terminals

Connector Mounting Method and Mounting Dimensions

Connector mounted on the face of the panel (front mounting)

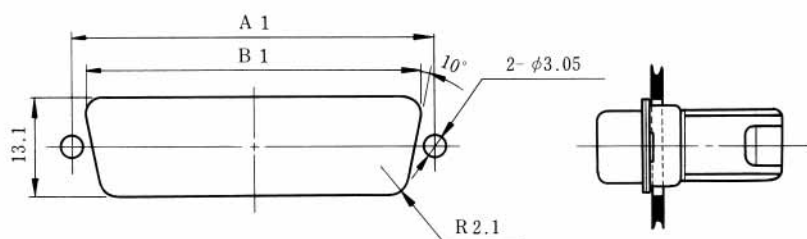

Unit: mm

Shell size	A2	B2
E	24.99	22
A	33.32	30.3
B	47.04	44
C	63.5	60.5

Connector mounted on the back of the panel (rear mounting)

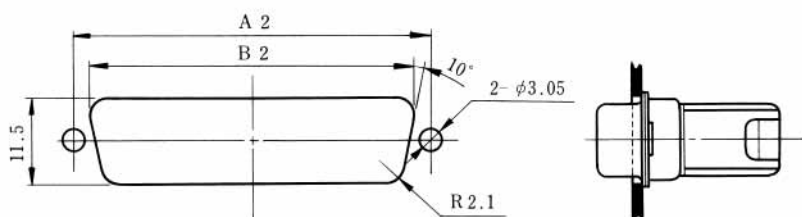

Unit: mm

Shell size	A2	B2
E	24.99	20.2
A	33.32	28.6
B	47.04	42.5
C	63.5	59.2

Assembling Procedure of Crimp Contact

Assembly Steps

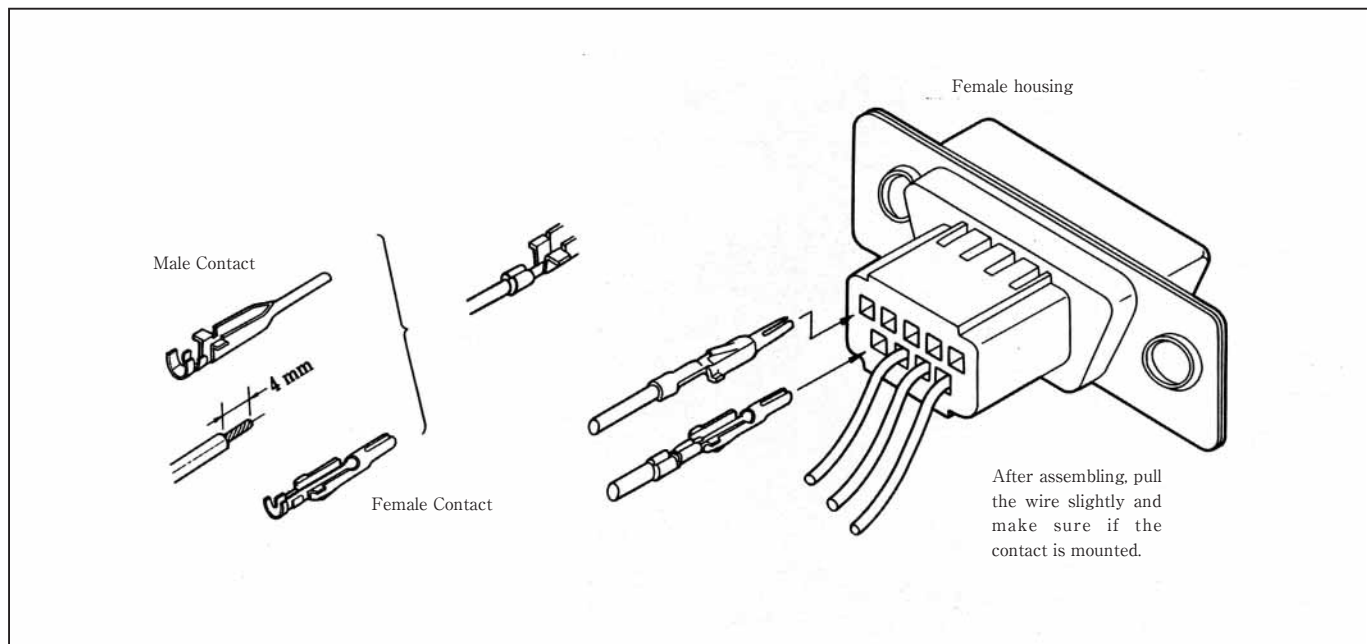

Procedure for Contact Extraction

In case of extracting a contact from the housing in insertion error or in circuit change, follow the steps as shown below:

(1) How to extract a contact

Insert a 1.1×0.5 mm thick board into the lance-fixed-hole of the housing as shown in Fig. 1 and extract the contact by pulling the wire.

(2) How to raise up a lance

When the extracted contact is installed again in the housing, please raise up the contact lance as shown in Fig. 2 and then insert it to the housing.

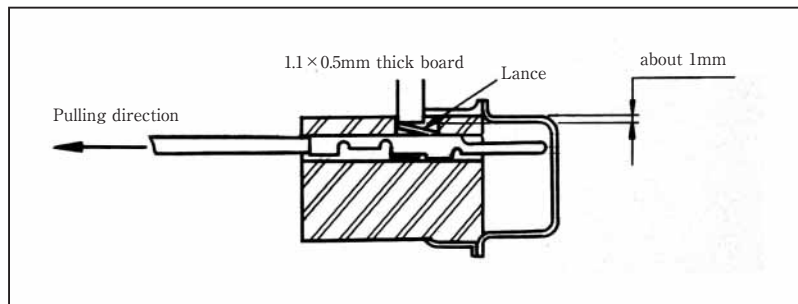

Fig. 1

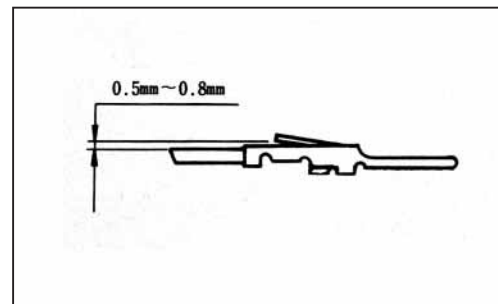
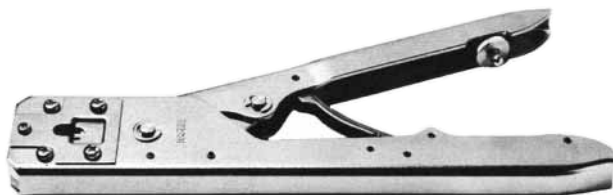

Fig. 2

Figure 1 illustrates a female contact. This also applies for a mate contact.

Tools

Hand Crimp Tool



HRS No	Part No.	Applicable contact	Applicable wire
CL250-0012-2	TC-CD-111	CD-PC-111	AWG-24-20 (Coating O.D.: ϕ 1.5- ϕ 1.9)
		CD-SC-111	
CL250-0013-5	TC-CD-121	CD-PC-121	AWG28-24 (Coating O.D.: ϕ 1.2- ϕ 1.5)
		CD-SC-121	

Auto Crimp Tool



Crimping machine

HRS No	Part No.
CL901-0005-4	CM-105

Applicator

HRS No	Part No.	Applicable wire
CL901-2517-7	AP105-CD-1	CD-PC-211
		SC-211
CL901-2518-0	AP105-CD-2	CD-PC-221
		SC-221

X-ON Electronics

Largest Supplier of Electrical and Electronic Components

Click to view similar products for [Crimpers](#) category:

Click to view products by [Hirose](#) manufacturer:

Other Similar products are found below :

[576771-1](#) [576788-2](#) [010-0041](#) [010-0055](#) [010-0096](#) [604228-1](#) [M225202-37](#) [CT150-2-D02](#) [CT150-4-LY2](#) [CT150-6-RH07](#) [M322](#) [63484-3701](#)
[63800-0140](#) [63800-8355](#) [63811-3275](#) [63811-3376](#) [63811-6375](#) [63811-6475](#) [63811-7875](#) [63811-8175](#) [63811-8875](#) [63819-0475](#) [63819-1875](#)
[63819-2875](#) [63819-4375](#) [63819-4475](#) [63823-3475](#) [63823-5175](#) [63823-6375](#) [63823-8375](#) [63827-5375](#) [64001-0975](#) [64001-2175](#) [64001-4175](#)
[662903-2](#) [690142-4](#) [690602-6](#) [D38999/20WA98JB-LC](#) [7-1633664-2](#) [7-22278-0](#) [7-22280-5](#) [7-240641-3](#) [762637-1](#) [808714-1](#) [8-1633117-3](#)
[853721-6](#) [91362-1](#) [995-0001-187](#) [1-1633932-5](#) [999-50-020083](#)