



# 80×80×38 mm

San Ace 80 9GA type Low Power Consumption Fan

## General Specifications

- Material ..... Frame: Plastic (Flammability: UL 94V-0), Impeller: Plastic (Flammability: UL 94V-0)
- Expected life ..... See the table below. (L10 life: 90% survival rate for continuous operation in free air at 60°C, rated voltage)
- Motor protection function ..... Locked rotor burnout protection, Reverse polarity protection  
For details, please refer to p. 529.
- Dielectric strength ..... 50/60 Hz, 500 VAC, for 1 minute (between lead wire conductors and frame)
- Insulation resistance ..... 10 MΩ or more with a 500 VDC megger (between lead wire conductors and frame)
- Sound pressure level (SPL) ..... At 1 m away from the air inlet
- Storage temperature ..... -30 to +70°C (Non-condensing)
- Lead wire ..... ⊕Red ⊖Black (Sensor) Yellow (Control) Brown
- Mass ..... 160 g

## Specifications

The models listed below **have ribs and pulse sensors with PWM control function.** For models without ribs, append "1" to the end of model numbers.

Model no.	Rated voltage [V]	Operating voltage range [V]	PWM duty cycle* [%]	Rated current [A]	Rated input [W]	Rated speed [min <sup>-1</sup> ]	Max. airflow [m <sup>3</sup> /min] [CFM]	Max. static pressure [Pa] [inchH <sub>2</sub> O]	SPL [dB (A)]	Operating temperature [°C]	Expected life [h]		
9GA0812P1G61	12	10.8 to 13.2	100	1.2	14.4	10500	2.85 100.6	480 1.93	60	-20 to +70	40000/60°C (70000/40°C)		
			0	0.04	0.48	2000	0.51 18.0	28.7 0.11	21				
9GA0812P1S61			100	0.94	11.28	9550	2.6 91.8	480 1.93	59				
			0	0.1	1.2	2900	0.74 26.1	60 0.24	27				
9GA0812P1H61			100	0.6	7.2	8250	2.25 79.4	380 1.53	55				
			0	0.08	0.96	2500	0.64 22.6	45 0.18	24				
9GA0824P1S61	24	20.4 to 27.6	100	0.47	11.28	9550	2.6 91.8	480 1.93	59				
			0	0.06	1.44	2900	0.74 26.1	60 0.24	27				
9GA0824P1H61			100	0.3	7.2	8250	2.25 79.4	380 1.53	55				
			0	0.05	1.2	2500	0.64 22.6	45 0.18	24				
9GA0848P1S61			48	40.8 to 55.2	100	0.25	12	9550	2.6 91.8			480 1.93	59
					0	0.04	1.92	2990	0.74 26.1			60 0.24	27

\* PWM frequency: 25 kHz

Other sensor specifications are available as options. Refer to the index (p. 552).

## Airflow - Static Pressure Characteristics / PWM Duty - Speed Characteristics Example

**9GA0812P1G61** With pulse sensor with PWM control function

PWM duty cycle

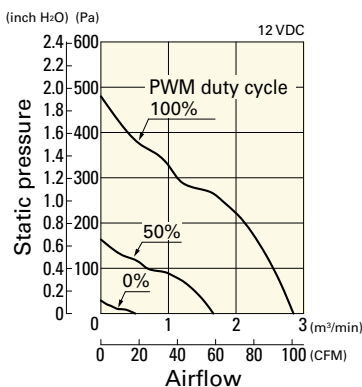

Operating voltage range

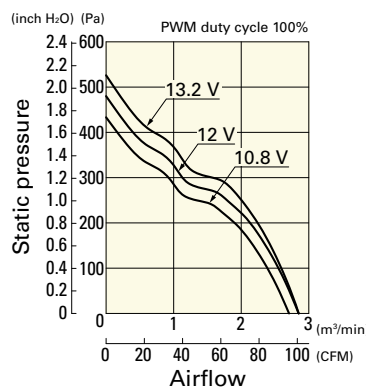

PWM duty - Speed characteristics example

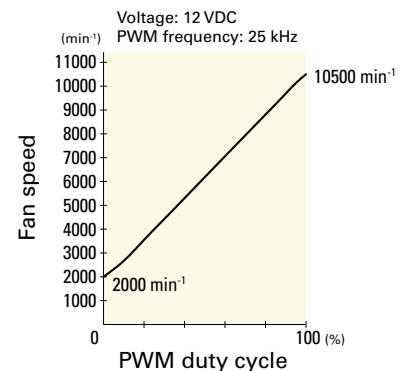

## Airflow - Static Pressure Characteristics / PWM Duty - Speed Characteristics Example

**9GA0812P1S61** With pulse sensor with PWM control function

PWM duty cycle

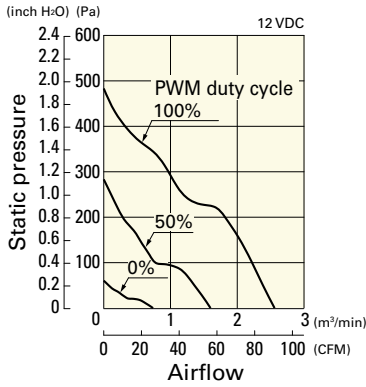

Operating voltage range

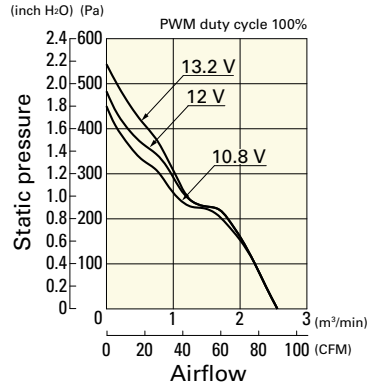

PWM duty - Speed characteristics example

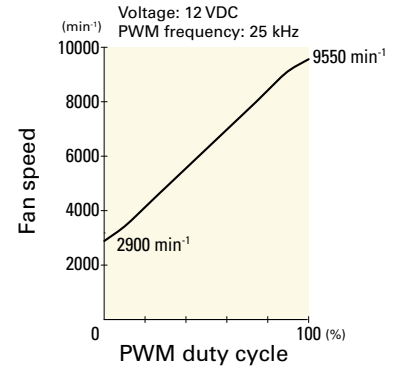

**9GA0812P1H61** With pulse sensor with PWM control function

PWM duty cycle

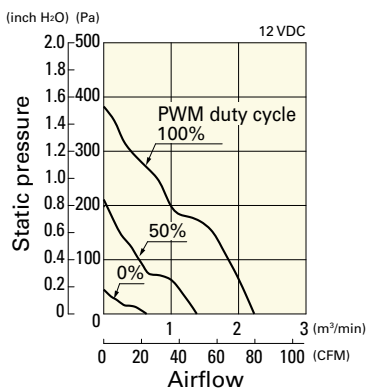

Operating voltage range

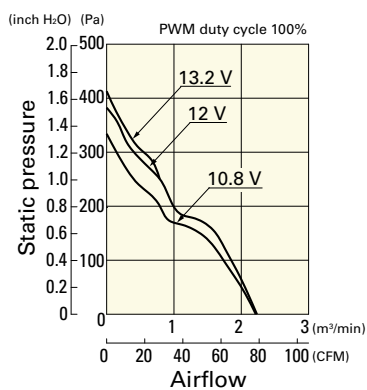

PWM duty - Speed characteristics example

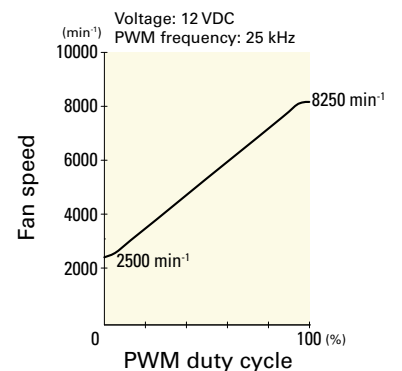

**9GA0824P1S61** With pulse sensor with PWM control function

PWM duty cycle

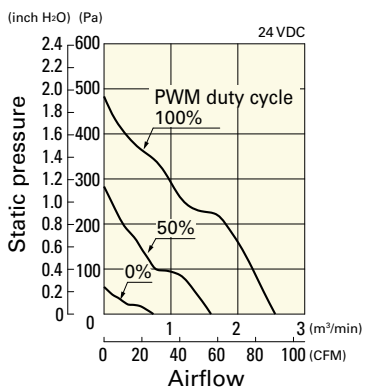

Operating voltage range

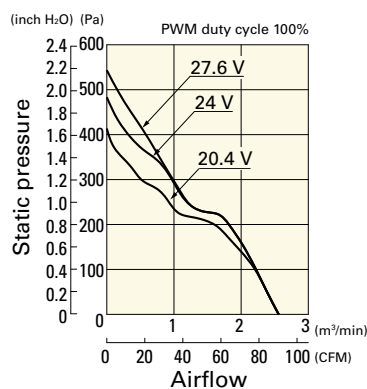

PWM duty - Speed characteristics example

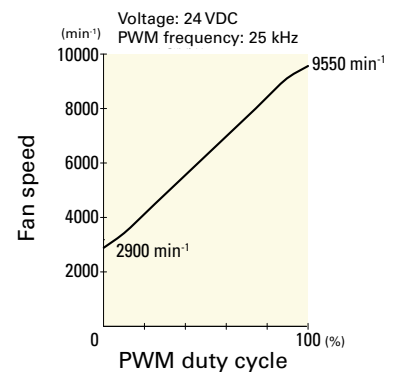

**9GA0824P1H61** With pulse sensor with PWM control function

PWM duty cycle

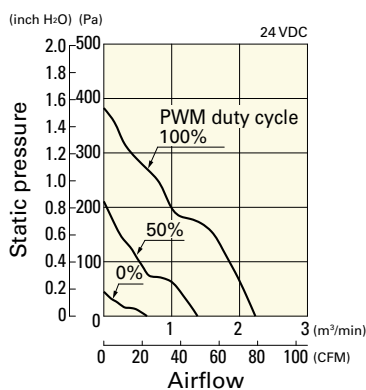

Operating voltage range

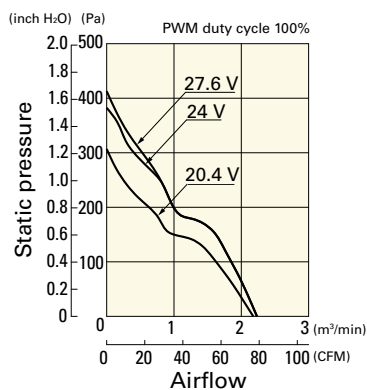

PWM duty - Speed characteristics example

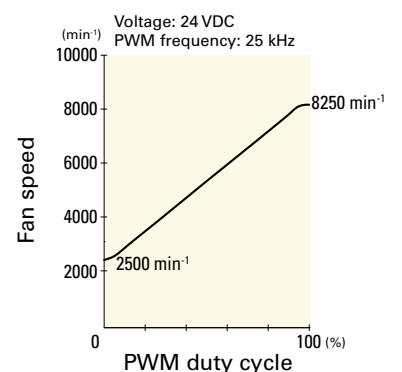

**Airflow - Static Pressure Characteristics / PWM Duty - Speed Characteristics Example**

**9GA0848P1S61** With pulse sensor with PWM control function

PWM duty cycle

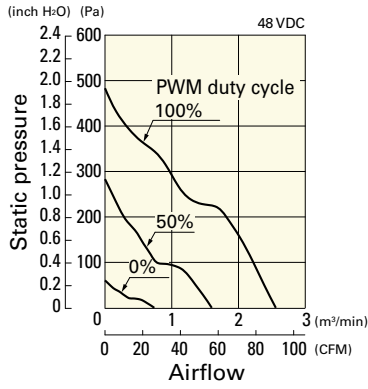

Operating voltage range

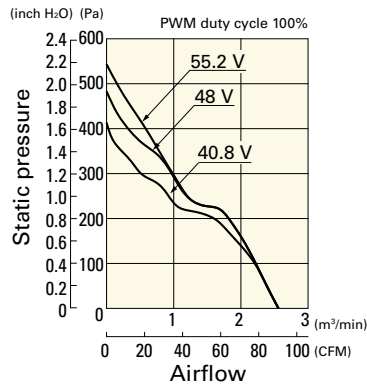

PWM duty - Speed characteristics example

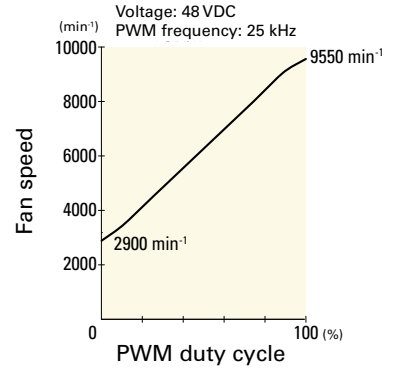

**Dimensions (unit: mm) (With ribs)**

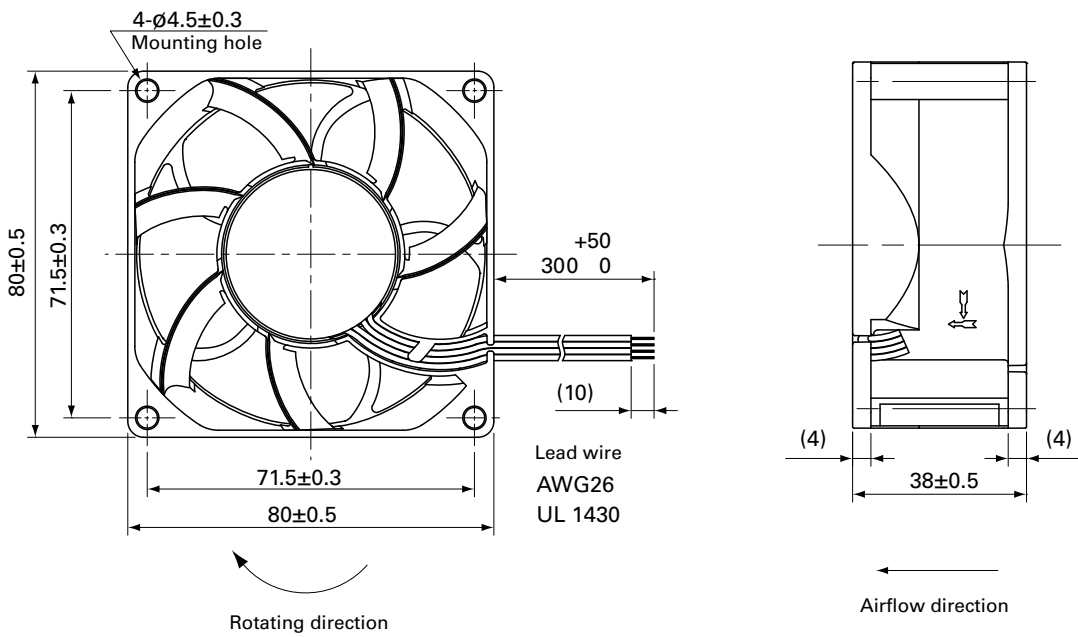

**Reference Dimensions of Mounting Holes and Vent Opening (unit: mm)**

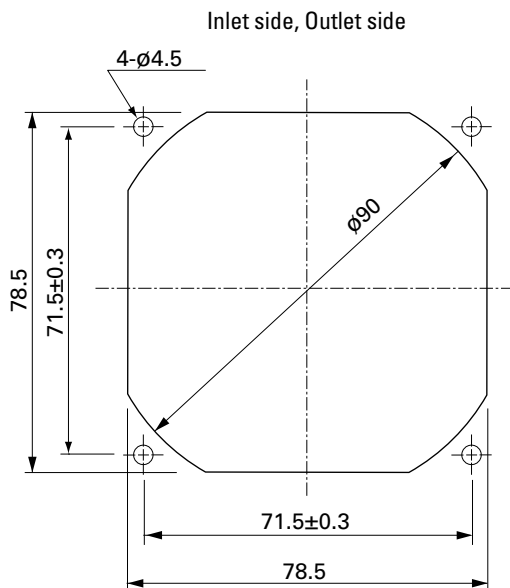

## Options

---

### Finger guards

page: p. 513

Model no.: 109-049C, 109-049E, 109-049H

### Resin finger guards

page: p. 520

Model no.: 109-1002G

### Resin filter kits

page: p. 521

Model no.: 109-1002F13 (13PPI), 109-1002F20 (20PPI),  
109-1002F30 (30PPI), 109-1002F40 (40PPI)

## X-ON Electronics

Largest Supplier of Electrical and Electronic Components

*Click to view similar products for [DC Fans](#) category:*

*Click to view products by [Sanyo Denki](#) manufacturer:*

Other Similar products are found below :

[614R](#) [6424/2HP-210](#) [8312R](#) [DV4118/2NP-183](#) [AFB0948HH-S687](#) [PFB0824DHE-8B72](#) [G2E085-AA05-10](#) [RD20S-4/210660](#) [4318/12T](#)  
[4418HH](#) [AUB0912H-F00](#) [3412N/2ME](#) [K2E225-RA92-09](#) [4184N/2XR](#) [5214N2HH](#) [614J2HHPR-010](#) [8412NGL-12](#) [4114N/12HHR-297](#)  
[4656](#) [ZWR-903](#) [4112N12GL-175](#) [KD2406PKB2.\(2\).GN](#) [AFB1248HHE](#) [AFB1212LE-F00](#) [FAN-SCH-1](#) [MF60151V1-1000U-G99](#)  
[PF80252V1-1000U-G99](#) [PF92252V1-1000U-G99](#) [4112N/2H6P](#) [4114N/17-251](#) [6212NH](#) [622/2N](#) [712F-011](#) [8218J/2NP-181](#) [W1G180-AB47-](#)  
[15](#) [FAA1-12038NBKW31-A](#) [6318N/2TDP](#) [6318N/2H3PU](#) [6318HU](#) [424JMU](#) [PMD1206PTVX-A.U.GN](#) [PF80251B2-000U-F99](#)  
[EF40101BX-1000U-G99](#) [AD1224LB-A71GL](#) [9GA0924L4021](#) [9GA0924M4021](#) [9GA0924M4011](#) [9GA0824B20011](#) [9GA0812A2D0011](#)  
[9GA0912M4D011](#) [9GA0924W4D01](#)