

CMSH3-20 CMSH3-60  
 CMSH3-40 CMSH3-100

**SURFACE MOUNT SILICON  
 SCHOTTKY RECTIFIERS  
 3.0 AMP, 20 THRU 100 VOLT**



**SMC CASE**



[www.centrasemi.com](http://www.centrasemi.com)

**DESCRIPTION:**

The CENTRAL SEMICONDUCTOR CMSH3-20 series 3.0 Amp surface mount silicon Schottky rectifiers are highly reliable components designed for use in all types of commercial, industrial, entertainment, computer, and automotive applications. To order devices on 16mm Tape and Reel (3000/13" Reel), add TR13 suffix to part number.

**MARKING CODE: SEE MARKING CODE TABLE ON FOLLOWING PAGE**

**FEATURES:**

- High reliability
- Special selections available
- "C" bend construction provides strain relief when mounted on PC board

**MAXIMUM RATINGS:** ( $T_A=25^\circ\text{C}$  unless otherwise noted)

	SYMBOL	CMSH3 -20	CMSH3 -40	CMSH3 -60	CMSH3 -100	UNITS
Peak Repetitive Reverse Voltage	$V_{RRM}$	20	40	60	100	V
DC Blocking Voltage	$V_R$	20	40	60	100	V
RMS Reverse Voltage	$V_{R(RMS)}$	14	28	42	71	V
Average Forward Current ( $T_A=75^\circ\text{C}$ )	$I_O$			3.0		A
Peak Forward Surge Current, $t_p=8.3\text{ms}$	$I_{FSM}$			150		A
Operating Junction Temperature	$T_J$		-65 to +150			$^\circ\text{C}$
Storage Temperature	$T_{stg}$		-65 to +175			$^\circ\text{C}$
Thermal Resistance	$\Theta_{JL}$			10		$^\circ\text{C/W}$

**ELECTRICAL CHARACTERISTICS:** ( $T_A=25^\circ\text{C}$  unless otherwise noted)

SYMBOL	TEST CONDITIONS	MIN	TYP	MAX	UNITS
$I_R$	$V_R=\text{Rated } V_{RRM}$			500	$\mu\text{A}$
$I_R$	$V_R=\text{Rated } V_{RRM}, T_A=100^\circ\text{C}$			20	$\text{mA}$
$V_F$	$I_F=3.0\text{A (CMSH3-20, -40)}$		0.47	0.50	V
$V_F$	$I_F=3.0\text{A (CMSH3-60)}$		0.56	0.70	V
$V_F$	$I_F=3.0\text{A (CMSH3-100)}$		0.75	0.80	V
$C_J$	$V_R=0, f=1.0\text{MHz (CMSH3-20)}$		511		$\text{pF}$
$C_J$	$V_R=0, f=1.0\text{MHz (CMSH3-40)}$		510		$\text{pF}$
$C_J$	$V_R=0, f=1.0\text{MHz (CMSH3-60)}$		278		$\text{pF}$
$C_J$	$V_R=0, f=1.0\text{MHz (CMSH3-100)}$		320		$\text{pF}$

CMSH3-20 CMSH3-60  
 CMSH3-40 CMSH3-100

**SURFACE MOUNT SILICON  
 SCHOTTKY RECTIFIERS  
 3.0 AMP, 20 THRU 100 VOLT**



**SMC CASE - MECHANICAL OUTLINE**

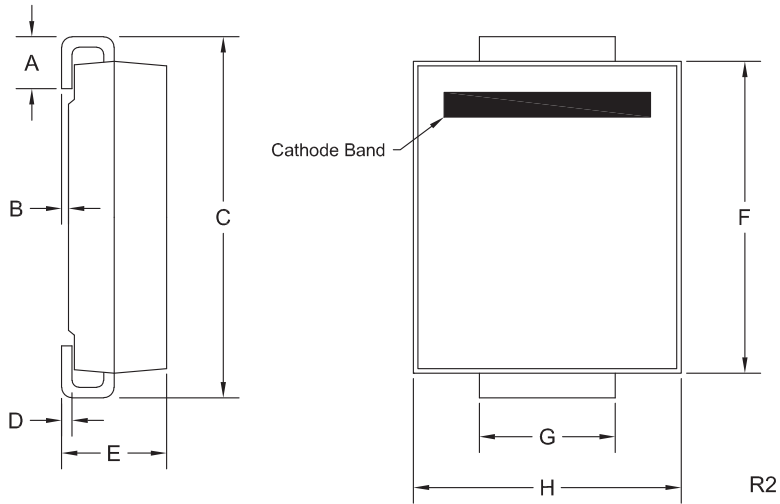

DEVICE	MARKING CODE
CMSH3-20	CS320
CMSH3-40	CS340
CMSH3-60	CS360
CMSH3-100	CS3100

SYMBOL	DIMENSIONS			
	INCHES		MILLIMETERS	
	MIN	MAX	MIN	MAX
A	0.030	0.060	0.76	1.52
B	0.002	0.008	0.05	0.20
C	0.305	0.320	7.75	8.13
D	0.006	0.012	0.15	0.31
E	0.079	0.103	2.00	2.62
F	0.260	0.280	6.60	7.11
G	0.108	0.128	2.75	3.25
H	0.220	0.245	5.59	6.22

SMC (REV: R2)

R6 (5-January 2016)

CMSH3-20 CMSH3-60  
 CMSH3-40 CMSH3-100

SURFACE MOUNT SILICON  
 SCHOTTKY RECTIFIERS  
 3.0 AMP, 20 THRU 100 VOLT



TYPICAL ELECTRICAL CHARACTERISTICS

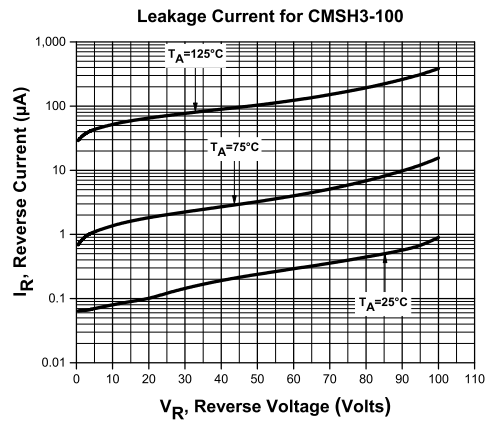
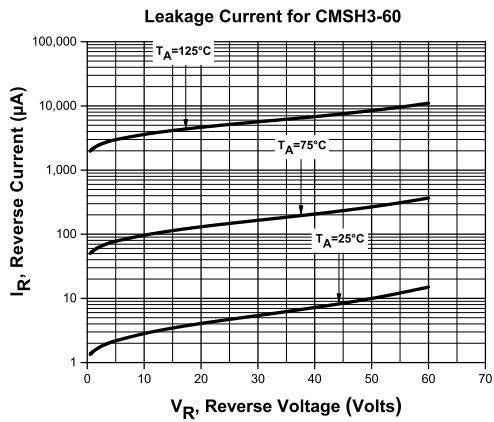
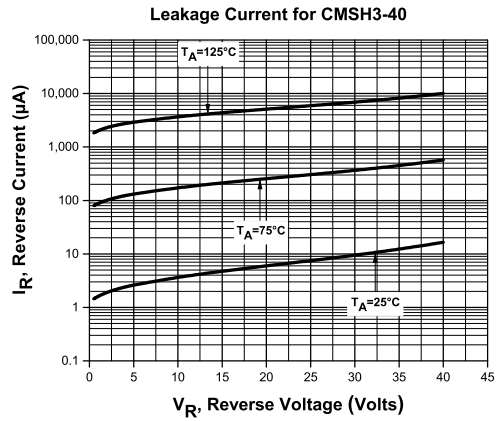
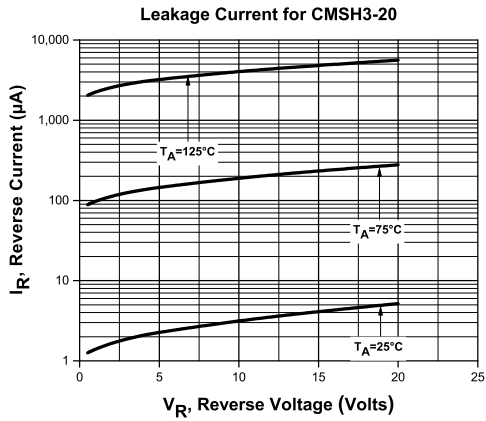

R6 (5-January 2016)

CMSH3-20 CMSH3-60  
 CMSH3-40 CMSH3-100

SURFACE MOUNT SILICON  
 SCHOTTKY RECTIFIERS  
 3.0 AMP, 20 THRU 100 VOLT



TYPICAL ELECTRICAL CHARACTERISTICS

Forward Voltage for CMSH3-20

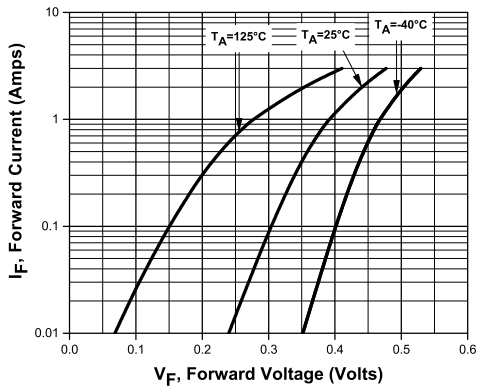

Forward Voltage for CMSH3-40

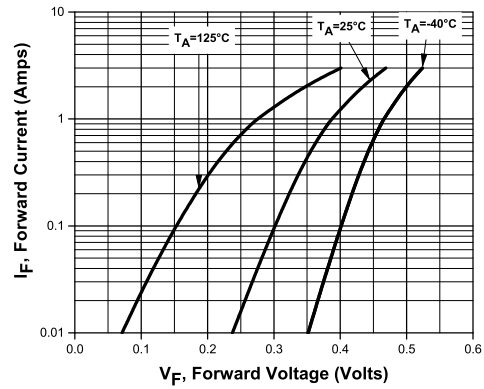

Forward Voltage for CMSH3-60

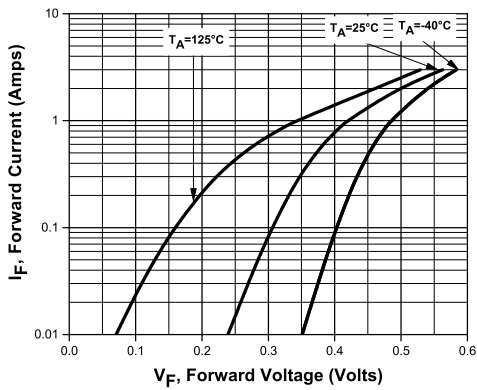

Forward Voltage for CMSH3-100

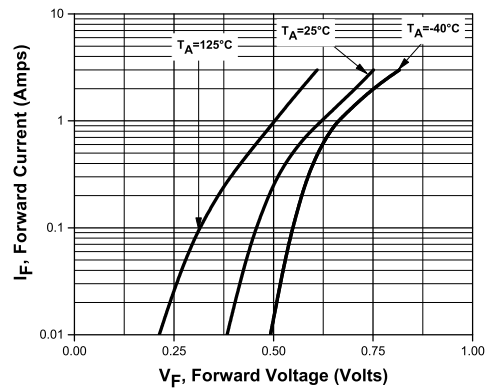

R6 (5-January 2016)

CMSH3-20 CMSH3-60  
CMSH3-40 CMSH3-100

SURFACE MOUNT SILICON  
SCHOTTKY RECTIFIERS  
3.0 AMP, 20 THRU 100 VOLT



### TYPICAL ELECTRICAL CHARACTERISTICS

Capacitance for CMSH3-20

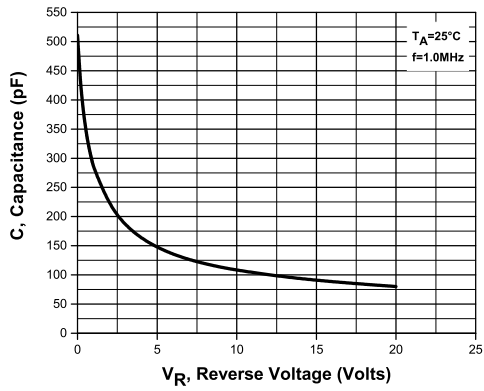

Capacitance for CMSH3-40

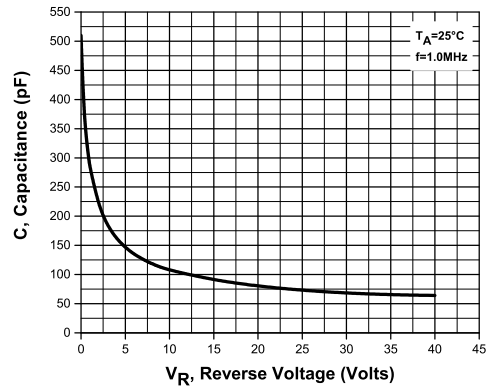

Capacitance for CMSH3-60

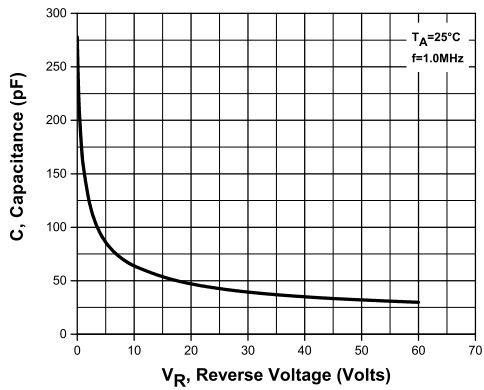

Capacitance for CMSH3-100

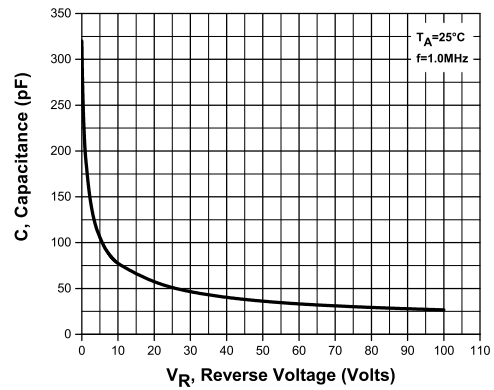

R6 (5-January 2016)

CMSH3-20    CMSH3-60  
CMSH3-40    CMSH3-100

SURFACE MOUNT SILICON  
SCHOTTKY RECTIFIERS  
3.0 AMP, 20 THRU 100 VOLT



### TYPICAL ELECTRICAL CHARACTERISTICS

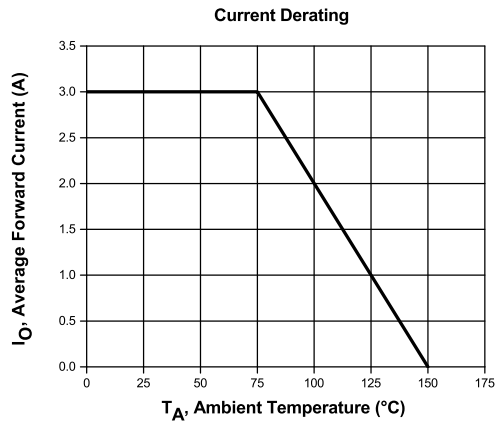

R6 (5-January 2016)



## OUTSTANDING SUPPORT AND SUPERIOR SERVICES

---

### PRODUCT SUPPORT

Central's operations team provides the highest level of support to insure product is delivered on-time.

- Supply management (Customer portals)
- Inventory bonding
- Consolidated shipping options
- Custom bar coding for shipments
- Custom product packing

---

### DESIGNER SUPPORT/SERVICES

Central's applications engineering team is ready to discuss your design challenges. Just ask.

- Free quick ship samples (2<sup>nd</sup> day air)
- Online technical data and parametric search
- SPICE models
- Custom electrical curves
- Environmental regulation compliance
- Customer specific screening
- Up-screening capabilities
- Special wafer diffusions
- PbSn plating options
- Package details
- Application notes
- Application and design sample kits
- Custom product and package development

---

### REQUESTING PRODUCT PLATING

1. If requesting Tin/Lead plated devices, add the suffix " TIN/LEAD" to the part number when ordering (example: 2N2222A TIN/LEAD).
2. If requesting Lead (Pb) Free plated devices, add the suffix " PBFREE" to the part number when ordering (example: 2N2222A PBFREE).

---

### CONTACT US

#### Corporate Headquarters & Customer Support Team

Central Semiconductor Corp.  
145 Adams Avenue  
Hauppauge, NY 11788 USA  
Main Tel: (631) 435-1110  
Main Fax: (631) 435-1824  
Support Team Fax: (631) 435-3388  
[www.centrasemi.com](http://www.centrasemi.com)

**Worldwide Field Representatives:**  
[www.centrasemi.com/wwreps](http://www.centrasemi.com/wwreps)

**Worldwide Distributors:**  
[www.centrasemi.com/wwdistributors](http://www.centrasemi.com/wwdistributors)

---

For the latest version of Central Semiconductor's **LIMITATIONS AND DAMAGES DISCLAIMER**, which is part of Central's Standard Terms and Conditions of sale, visit: [www.centrasemi.com/terms](http://www.centrasemi.com/terms)

## X-ON Electronics

Largest Supplier of Electrical and Electronic Components

*Click to view similar products for [Schottky Diodes & Rectifiers](#) category:*

*Click to view products by [Central Semiconductor](#) manufacturer:*

Other Similar products are found below :

[CUS06\(Te85L,Q,M\)](#) [MA4E2039](#) [D1FH3-5063](#) [MBR0530L-TP](#) [MBR10100CT-BP](#) [MBR30H100MFST1G](#) [MMBD301M3T5G](#) [PMAD1103-LF](#) [PMAD1108-LF](#) [RB160M-50TR](#) [RB520S-30](#) [RB551V-30](#) [DD350N18K](#) [DZ435N40K](#) [DZ600N16K](#) [BAS16E6433HTMA1](#) [BAS 3010S-02LRH E6327](#) [BAT 54-02LRH E6327](#) [IDL02G65C5XUMA1](#) [NSR05F40QNXT5G](#) [JANS1N6640](#) [SB07-03C-TB-H](#) [SB1003M3-TL-W](#) [SBAT54CWT1G](#) [SK32A-LTP](#) [SK33A-TP](#) [SK34A-TP](#) [SK34B-TP](#) [SMD1200PL-TP](#) [ACDBN160-HF](#) [SS3003CH-TL-E](#) [STPS30S45CW](#) [PDS3100Q-7](#) [GA01SHT18](#) [CRS10I30A\(Te85L,QM\)](#) [MA4E2501L-1290](#) [MBR1240MFST1G](#) [MBRB30H30CT-1G](#) [BAS28E6433HTMA1](#) [BAS 70-02L E6327](#) [HSB123JTR-E](#) [JANTX1N5712-1](#) [VS-STPS40L45CW-N3](#) [DD350N12K](#) [SB007-03C-TB-E](#) [SK110-LTP](#) [SK154-TP](#) [SK32A-TP](#) [SK33B-TP](#) [SK35A-TP](#)