



CT8xx Series

Digital TMR Latch for Consumer & Industrial Applications

Product Description

The CT8xx Series of integrated magnetic latches are designed for consumer and industrial switching applications. It is based on Crocus Technology's patented Magnetic Logic Unit™ (MLU™) technology with integrated CMOS process to provide a monolithic solution for superior sensing performance.

This series of magnetic latches feature an industry leading low power consumption as low as 200 nA. They are capable of handling large air gap applications with low magnetic fields down to 0.9 mT with best in class high frequency performance. The CT8xx is offered in active-low push-pull CMOS and open drain configuration for design flexibility. The latches are available in a low profile and small form factor 4-lead LGA and 3-lead SOT-23 packages, providing cost effective and space-saving solutions for high volume manufacturing. Please contact factory for custom solutions.



SOT-23 Package

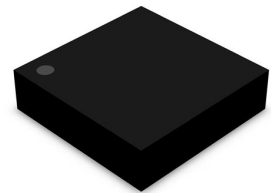

1.40 x 1.40 x 0.44 mm LGA

Features

- High sensitivity, B_{OP} as low as 0.9 mT
- Resistant to mechanical stress
- Ultra-low power consumption as low as 200 nA
- Digital CMOS push-pull and open drain options
- Low profile and small form factor packaging
- RoHS Compliant

Applications

- IoT devices
- Smartphones, tablets, and laptops
- Door or lid closure detection
- Reed switch replacement
- Motor controllers
- Proximity detection
- Power switch or open-close detection
- Tamper-proofing for utility meters
- Fluid level detection



Figure 1: Package Pin-out with Axis of Sensitivity Diagrams

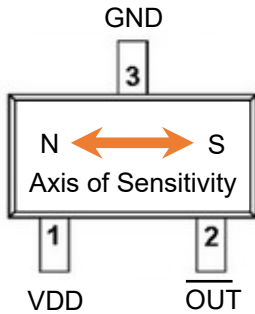

SOT-23 Package for CT831/2 and CT852

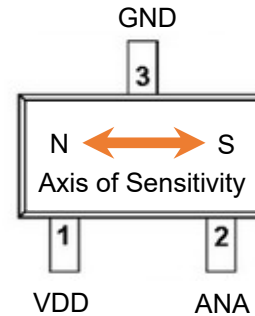

SOT-23 Package for CT834DR-IS3

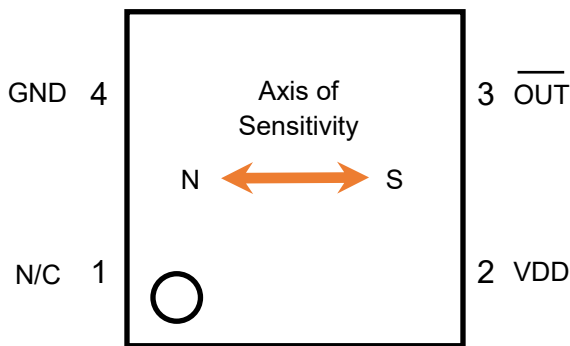

LGA Package for CT832

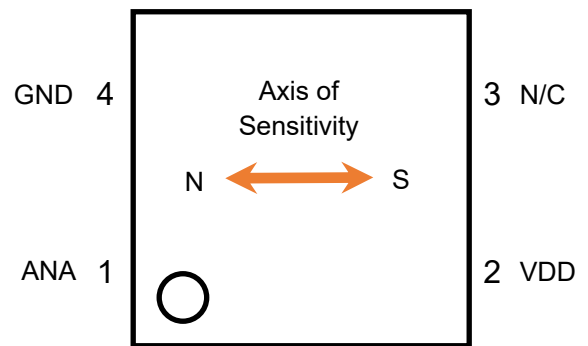

LGA Package for CT834DR-IL1

Table 1: Pin-out Information

Pin # for SOT23 Package	Pin # for LGA Package	Pin Name	Pin Description
CT831/2/4, CT852	CT832BV, CT834		
1	2	VDD	Supply Voltage
2	3	$\overline{\text{OUT}}$ ANA N/C	Output Signal (Active LOW) for CT831/2 and CT852. Analog Output for CT834 in SOT23 Package No Connect for CT834 in LGA Package.
3	4	GND	Ground
-	1	ANA (or N/C)	Analog Output for CT834. No Connect for CT832.



Table 2: Absolute Maximum Ratings

Exceeding the absolute maximum ratings may cause permanent damage. Exposure to absolute maximum rated conditions for extended periods may affect device reliability.

Parameter	Symbol	Min	Max	Unit
Supply Voltage	V_{DD}	-0.3	4.0	V
Push-pull Output (Active LOW)	V_{OUT_PP}	-0.3	$V_{DD} + 0.3$	V
Open Drain Output Voltage (Active LOW)	V_{OUT_OD}	-0.3	5.5	V
Analog Output	V_{ANA}	-0.3	$V_{DD} + 0.3$	V
Input and Output Current	I_{IN} / I_{OUT}	-10	+10	mA
Junction temperature	T_J	-40	+125	°C
Storage temperature	T_{STG}	-65	+150	°C
Soldering temperature	T_{SOL}		+260	°C
ESD Level, Human Body Model per JESD22-A114	V_{ESD_HBM}	±4.0		kV

Table 3: Recommended Operating Conditions

The Recommended Operating Conditions table defines the conditions for the actual device operation. Recommended operating conditions are specified to ensure optimal performance to the data sheet specifications. Crocus Technology does not recommend exceeding them or designing to absolute maximum ratings.

Parameter	Symbol	Conditions	Min	Typ	Max	Unit
Supply Voltage	V_{DD}		2.7	3.0	3.6	V
Output Voltage	V_{OUT}				3.6	V
Operating Magnetic Flux	B			$4 \times B_{OP}$		mT
Ambient Temperature	T_A		-40	+25	+125	°C
Junction Temperature	T_J		-40		+125	°C

Table 4: Thermal Properties

Junction-to-ambient thermal resistance is a function of application and board layout and is determined in accordance to JEDEC standard JESD51 for a four (4) layer 2s2p FR-4 printed circuit board (PCB). Special attention must be paid not to exceed junction temperature $T_{J(MAX)}$ at a given ambient temperature.

Parameter	Symbol	Min	Typ	Max	Unit
Junction-to-Ambient Thermal Resistance for SOT23 Package	$\theta_{JA(SOT23)}$		202		°C/W
Junction-to-Ambient Thermal Resistance for LGA Package	$\theta_{JA(LGA)}$		165		°C/W



Table 5: Electrical Characteristics for CT8xx Series

Unless otherwise specified: $V_{DD} = 2.7\text{ V to }3.6\text{ V}$, $T_A = -40^\circ\text{C to }+125^\circ\text{C}$. Typical values are $V_{DD} = 3.0\text{ V}$ and $T_A = +25^\circ\text{C}$.

Parameter	Symbol	Conditions	Min	Typ	Max	Unit
Power-On Time	t_{ON}	$V_{DD} > 2.7\text{ V}$		500		μs
Output Voltage High $\overline{\text{OUT}}$	V_{OH}	$I_{OUT} = -2\text{ mA}$	$0.9 \times V_{DD}$			V
Output Voltage Low $\overline{\text{OUT}}$	V_{OL}	$I_{OUT} = +2\text{ mA}$			$0.1 \times V_{DD}$	V
Current for $\overline{\text{OUT}}$	I_{OUT}			± 2		mA
Under-voltage Lockout Threshold, Rising V_{DD}	V_{UVLO_RISE}	Rising V_{DD}		2.20	2.60	V
Under-voltage Lockout Threshold, Falling V_{DD}	V_{UVLO_FALL}	Falling V_{DD}	1.90	2.15		V
Under-voltage Lockout Hysteresis	V_{UV_HYST}			50		mV

Typical Characteristics for CT8xx

$V_{DD} = 3.0\text{ V}$ and $T_A = +25^\circ\text{C}$, $C_{DD} = 1.0\ \mu\text{F}$ (unless otherwise specified).

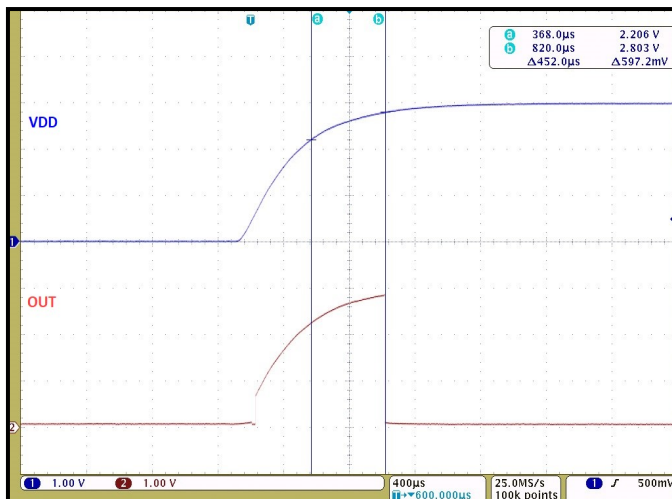

Figure 2. Power-On Time for Push-pull Output (V_{DD} and $\overline{\text{OUT}}$)

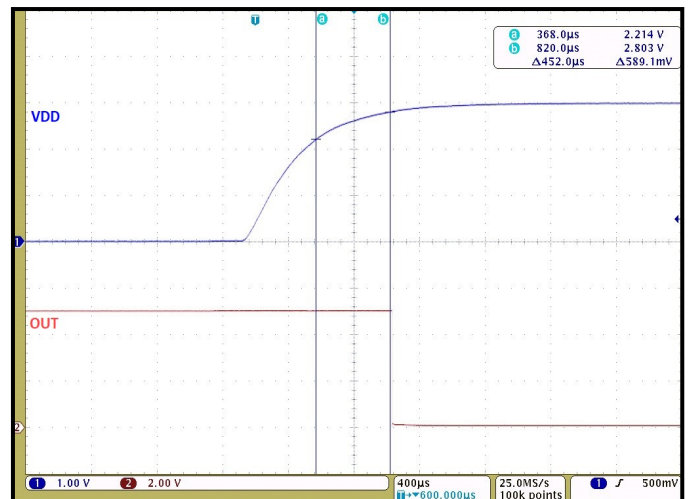

Figure 3. Power-On Time for Open Drain Output (V_{DD} and $\overline{\text{OUT}}$)



Table 6: Electrical Characteristics for CT831BV

Unless otherwise specified: $V_{DD} = 2.7\text{ V to }3.6\text{ V}$, $T_A = -40^\circ\text{C to }+125^\circ\text{C}$. Typical values are $V_{DD} = 3.0\text{ V}$ and $T_A = +25^\circ\text{C}$.

Parameter	Symbol	Conditions	Min	Typ	Max	Unit
Average Supply Current	$I_{DD(AVG)}$	$t = 10\text{ s}$		200	700	nA
Output Voltage High	V_{OH}				5.5	V
Output Voltage Low	V_{OL}	$I_{OUT} \leq 20\text{ mA}$	0		0.5	V
High Output Leakage Current	I_{LEAK}	$V_{OH} = 5.5\text{ V}, B = 0$		20		pA
Sampling Frequency	f_s		1	2	4	Hz
Active Mode Time	t_{ACT}			1.4		μs
Idle Mode Time	t_{SLP}			500		ms
Operate Point	B_{OPS}		2.7	3.0	3.8	mT
Operate Point	B_{OPN}		-3.8	-3.0	-2.7	mT
Release point	B_{RPS}		1.8	2.0	2.7	mT
Release point	B_{RPN}		-2.7	-2.0	-1.8	mT
Hysteresis	B_{HYST}	$B_{HYST} = B_{OP} - B_{RP}$	0.5	1.0		mT

Table 7: Electrical Characteristics for CT832BV

Unless otherwise specified: $V_{DD} = 2.7\text{ V to }3.6\text{ V}$, $T_A = -40^\circ\text{C to }+125^\circ\text{C}$. Typical values are $V_{DD} = 3.0\text{ V}$ and $T_A = +25^\circ\text{C}$.

Parameter	Symbol	Conditions	Min	Typ	Max	Unit
Average Supply Current	$I_{DD(AVG)}$	$t = 10\text{ s}$		200	700	nA
Sampling Frequency	f_s		1	2	4	Hz
Active Mode Time	t_{ACT}			1.4		μs
Idle Mode Time	t_{IDLE}			500		ms
Operate Point	B_{OPS}		2.7	3.0	3.8	mT
Operate Point	B_{OPN}		-3.8	-3.0	-2.7	mT
Release point	B_{RPS}		1.8	2.0	2.7	mT
Release point	B_{RPN}		-2.7	-2.0	-1.8	mT
Hysteresis	B_{HYST}	$B_{HYST} = B_{OP} - B_{RP}$	0.5	1.0		mT



Typical Characteristics for CT831BV and CT832BV

$V_{DD} = 3.0\text{ V}$ and $T_A = +25^\circ\text{C}$, $C_{DD} = 1.0\ \mu\text{F}$ (unless otherwise specified).

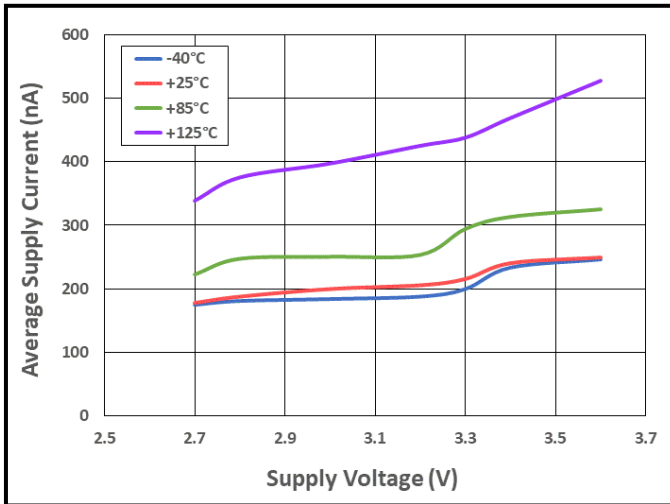

Figure 4. Average Supply Current vs. Supply Voltage vs. Temperature

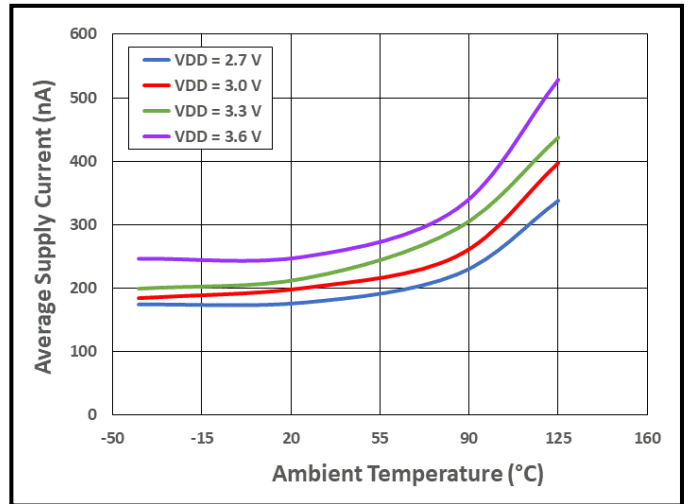

Figure 5. Average Supply Current vs. Temperature vs. Supply Voltage

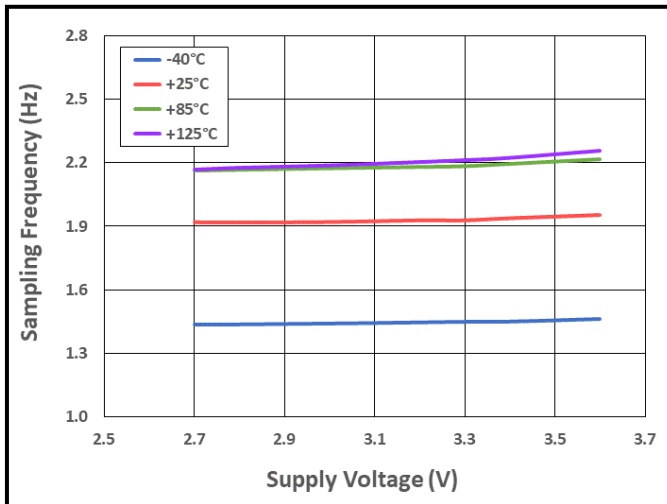

Figure 6. Sampling Frequency vs. Supply Voltage vs. Temperature



Table 8: Electrical Characteristics for CT832SK

Unless otherwise specified: $V_{DD} = 2.7\text{ V to }3.6\text{ V}$, $T_A = -40^\circ\text{C to }+125^\circ\text{C}$. Typical values are $V_{DD} = 3.0\text{ V}$ and $T_A = +25^\circ\text{C}$.

Parameter	Symbol	Conditions	Min	Typ	Max	Unit
Average Supply Current	$I_{DD(AVG)}$	$t = 10\text{ s}$		230	700	nA
Sampling Frequency	f_S		7	10	13	Hz
Active Mode Time	t_{ACT}			1.4		μs
Idle Mode Time	t_{IDLE}			100		ms
Operate Point	B_{OPS}		0.8	0.9	1.2	mT
Operate Point	B_{OPN}		-1.2	-0.9	-0.8	mT
Release point	B_{RPS}		0.3	0.5	0.7	mT
Release point	B_{RPN}		-0.7	-0.5	-0.3	mT
Hysteresis	B_{HYST}	$B_{HYST} = B_{OP} - B_{RP}$	0.3	0.4		mT

Table 9: Electrical Characteristics for CT832EK

Unless otherwise specified: $V_{DD} = 2.7\text{ V to }3.6\text{ V}$, $T_A = -40^\circ\text{C to }+125^\circ\text{C}$. Typical values are $V_{DD} = 3.0\text{ V}$ and $T_A = +25^\circ\text{C}$.

Parameter	Symbol	Conditions	Min	Typ	Max	Unit
Average Supply Current	$I_{DD(AVG)}$	$t = 10\text{ s}$		230	700	nA
Sampling Frequency	f_S		7	10	13	Hz
Active Mode Time	t_{ACT}			1.4		μs
Idle Mode Time	t_{IDLE}			100		ms
Operate Point	B_{OPS}			7.0		mT
Operate Point	B_{OPN}			-7.0		mT
Release Point	B_{RPS}			5.0		mT
Release Point	B_{RPN}			-5.0		mT
Hysteresis	B_{HYST}	$B_{HYST} = B_{OP} - B_{RP}$		2.0		mT



Typical Characteristics for CT832SK and CT832EK

$V_{DD} = 3.0\text{ V}$ and $T_A = +25^\circ\text{C}$, $C_{DD} = 1.0\ \mu\text{F}$ (unless otherwise specified).

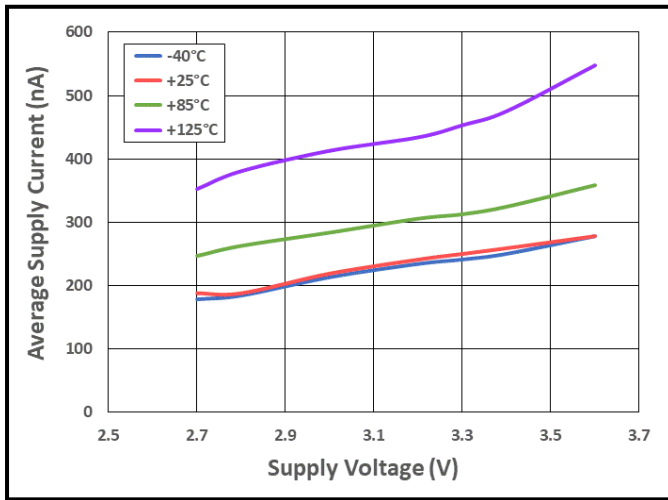

Figure 7. Average Supply Current vs. Supply Voltage vs. Temperature

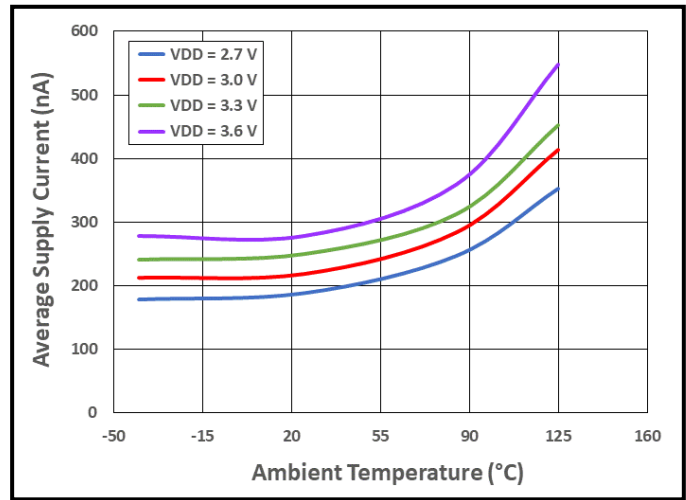

Figure 8. Average Supply Current vs. Temperature vs. Supply Voltage

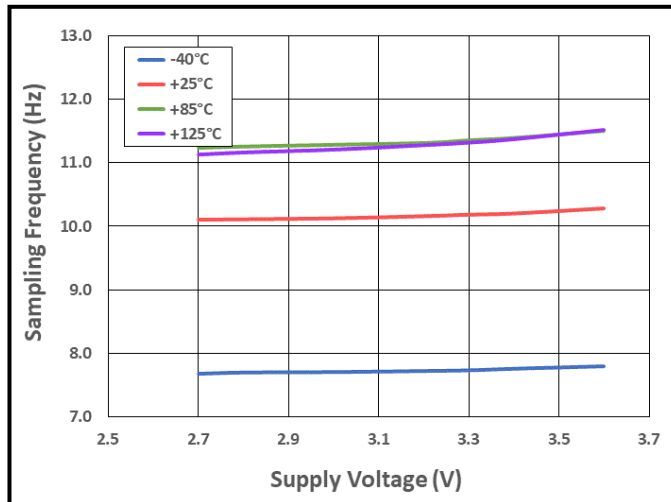

Figure 9. Sampling Frequency vs. Supply Voltage vs. Temperature



Table 10: Electrical Characteristics for CT832SL

Unless otherwise specified: $V_{DD} = 2.7\text{ V to }3.6\text{ V}$, $T_A = -40^\circ\text{C to }+125^\circ\text{C}$. Typical values are $V_{DD} = 3.0\text{ V}$ and $T_A = +25^\circ\text{C}$.

Parameter	Symbol	Conditions	Min	Typ	Max	Unit
Average Supply Current	$I_{DD(AVG)}$	$t = 10\text{ s}$		1.4	2.5	μA
Sampling Frequency	f_S		165	250	300	Hz
Active Mode Time	t_{ACT}			1.4		μs
Idle Mode Time	t_{IDLE}			4.0		ms
Operate Point	B_{OPS}		0.8	0.9	1.2	mT
Operate Point	B_{OPN}		-1.2	-0.9	-0.8	mT
Release point	B_{RPS}		0.3	0.5	0.7	mT
Release point	B_{RPN}		-0.7	-0.5	-0.3	mT
Hysteresis	B_{HYST}	$B_{HYST} = B_{OP} - B_{RP}$	0.3	0.4		mT

Table 11: Electrical Characteristics for CT832BL

Unless otherwise specified: $V_{DD} = 2.7\text{ V to }3.6\text{ V}$, $T_A = -40^\circ\text{C to }+125^\circ\text{C}$. Typical values are $V_{DD} = 3.0\text{ V}$ and $T_A = +25^\circ\text{C}$.

Parameter	Symbol	Conditions	Min	Typ	Max	Unit
Average Supply Current	$I_{DD(AVG)}$	$t = 10\text{ s}$		1.4	2.5	μA
Sampling Frequency	f_S		165	250	300	Hz
Active Mode Time	t_{ACT}			1.4		μs
Idle Mode Time	t_{IDLE}			4.0		ms
Operate Point	B_{OPS}		2.7	3.0	3.8	mT
Operate Point	B_{OPN}		-3.8	-3.0	-2.7	mT
Release point	B_{RPS}		1.8	2.0	2.7	mT
Release point	B_{RPN}		-2.7	-2.0	-1.8	mT
Hysteresis	B_{HYST}	$B_{HYST} = B_{OP} - B_{RP}$	0.5	1.0		mT



Typical Characteristics for CT832SL and CT832BL

$V_{DD} = 3.0\text{ V}$ and $T_A = +25^\circ\text{C}$, $C_{DD} = 1.0\ \mu\text{F}$ (unless otherwise specified).

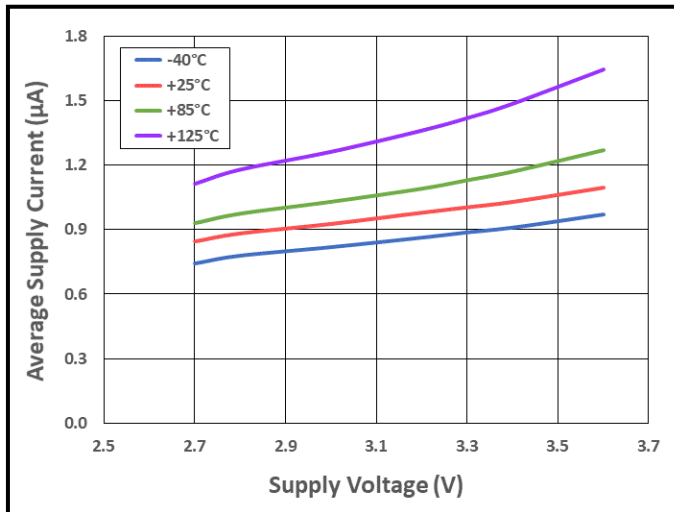

Figure 10. Average Supply Current vs. Supply Voltage vs. Temperature

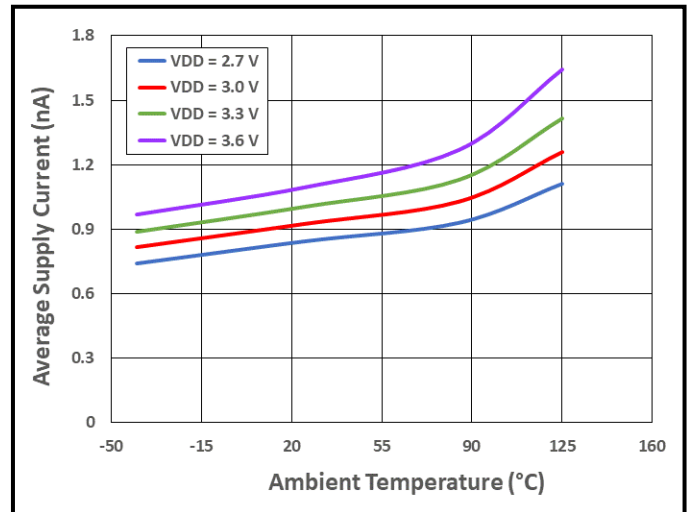

Figure 11. Average Supply Current vs. Temperature vs. Supply Voltage

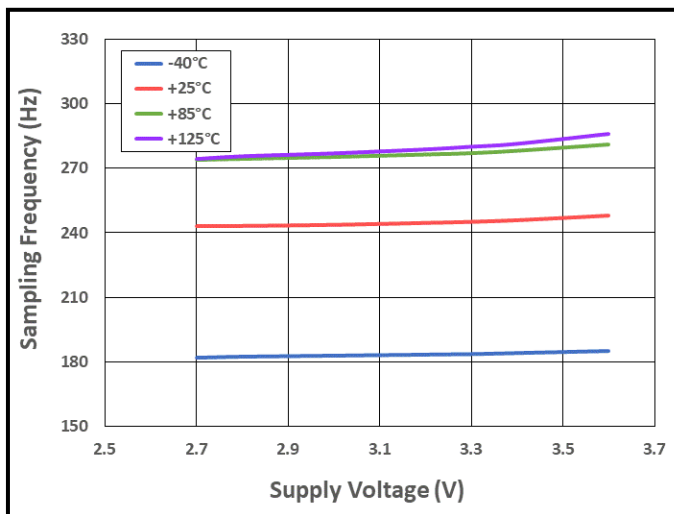

Figure 12. Sampling Frequency vs. Supply Voltage vs. Temperature



Table 12: Electrical Characteristics for CT832DM

Unless otherwise specified: $V_{DD} = 2.7\text{ V to }3.6\text{ V}$, $T_A = -40^\circ\text{C to }+125^\circ\text{C}$. Typical values are $V_{DD} = 3.0\text{ V}$ and $T_A = +25^\circ\text{C}$.

Parameter	Symbol	Conditions	Min	Typ	Max	Unit
Average Supply Current	$I_{DD(AVG)}$	$t = 10\text{ s}$		8	13	μA
Sampling Frequency	f_S		1.63	2.50	3.25	kHz
Active Mode Time	t_{ACT}			1.4		μs
Idle Mode Time	t_{IDLE}			400		μs
Operate Point	B_{OPS}		1.3	1.5	1.8	mT
Operate Point	B_{OPN}		-1.8	-1.5	-1.3	mT
Release point	B_{RPS}		0.8	1.0	1.3	mT
Release point	B_{RPN}		-1.3	-1.0	-0.8	mT
Hysteresis	B_{HYST}	$B_{HYST} = B_{OP} - B_{RP}$	0.3	0.5		mT

Typical Characteristics for CT832DM

$V_{DD} = 3.0\text{ V}$ and $T_A = +25^\circ\text{C}$, $C_{DD} = 1.0\text{ }\mu\text{F}$ (unless otherwise specified).

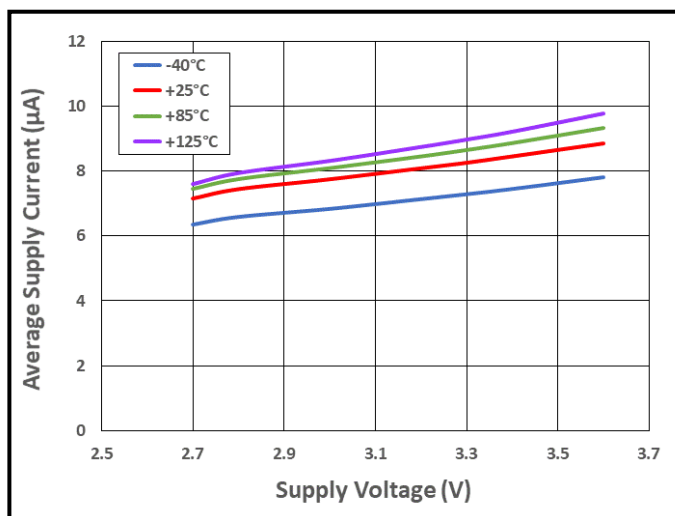

Figure 13. Average Supply Current vs. Supply Voltage vs. Temperature

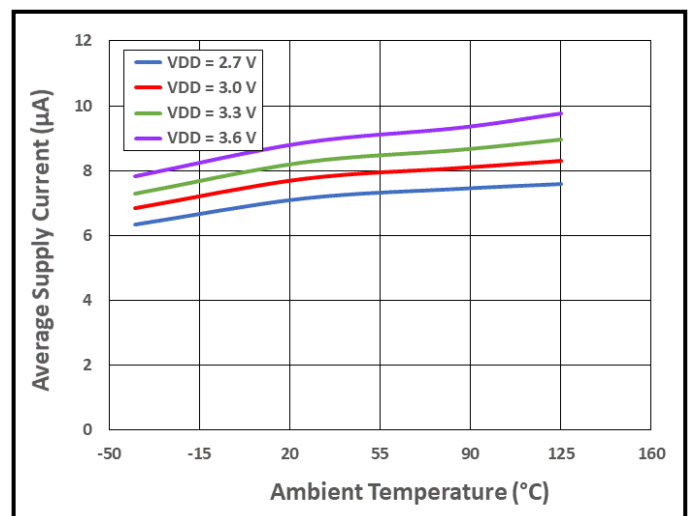

Figure 14. Average Supply Current vs. Temperature vs. Supply Voltage



Typical Characteristics for CT832DM

$V_{DD} = 3.0\text{ V}$ and $T_A = +25^\circ\text{C}$, $C_{DD} = 1.0\ \mu\text{F}$ (unless otherwise specified).

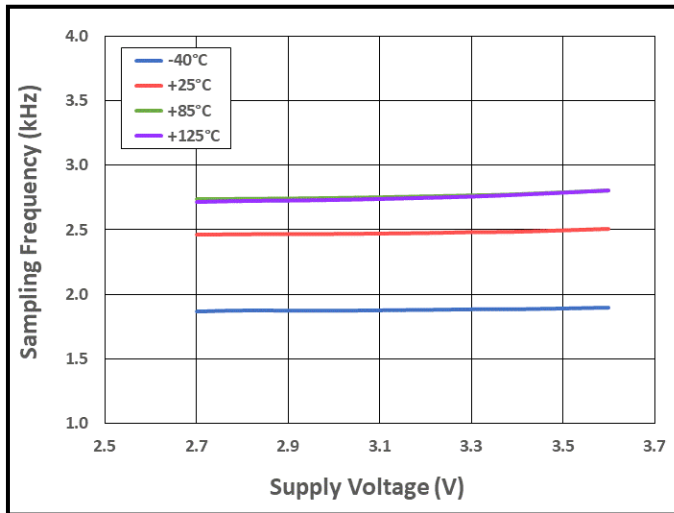

Figure 15. Sampling Frequency vs. Supply Voltage vs. Temperature



Table 13: Electrical Characteristics for CT832BH

Unless otherwise specified: $V_{DD} = 2.7\text{ V to }3.6\text{ V}$, $T_A = -40^\circ\text{C to }+125^\circ\text{C}$. Typical values are $V_{DD} = 3.0\text{ V}$ and $T_A = +25^\circ\text{C}$.

Parameter	Symbol	Conditions	Min	Typ	Max	Unit
Average Supply Current	$I_{DD(AVG)}$	$t = 10\text{ s}$		1.6	2.7	mA
Sampling Frequency	f_s		7	10	13	kHz
Active Mode Time	t_{ACT}			1.4		μs
Idle Mode Time	t_{IDLE}			100		μs
Operate Point	B_{OPS}		2.7	3.0	3.8	mT
Operate Point	B_{OPN}		-3.8	-3.0	-2.7	mT
Release Point	B_{RPS}		1.8	2.0	2.7	mT
Release Point	B_{RPN}		-2.7	-2.0	-1.8	mT
Hysteresis	B_{HYST}	$B_{HYST} = B_{OP} - B_{RP}$	0.5	1.0		mT

Typical Characteristics for CT832BH

$V_{DD} = 3.0\text{ V}$ and $T_A = +25^\circ\text{C}$, $C_{DD} = 1.0\text{ }\mu\text{F}$ (unless otherwise specified).

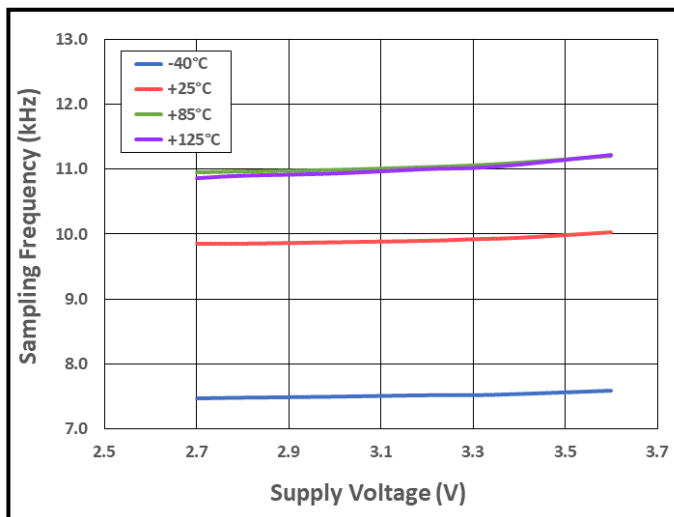

Figure 16. Sampling Frequency vs. Supply Voltage vs. Temperature



Table 14: Electrical Characteristics for CT834DR

Unless otherwise specified: $V_{DD} = 2.7\text{ V to }3.6\text{ V}$, $T_A = -40^\circ\text{C to }+85^\circ\text{C}$. Typical values are $V_{DD} = 3.0\text{ V}$ and $T_A = +25^\circ\text{C}$.

Parameter	Symbol	Conditions	Min	Typ	Max	Unit
Operating Temperature	T_A		-40		+85	$^\circ\text{C}$
Average Supply Current	$I_{DD(AVG)}$	$t = 10\text{ s}$		1.5	2.7	mA
Maximum Drive Capability	$I_{DRV(MAX)}$	V_{ANA} covers 19% V_{DD} to 81% V_{DD} span	-10		+10	μA
Output Capacitive Load	C_L				10	pF
Analog Output Magnetic Field Range	B_{ANA}		-1.0		+1.0	mT
Analog Output Voltage Range	V_{ANA}		$0.19 \times V_{DD}$		$0.81 \times V_{DD}$	V
Voltage Output Quiescent	V_{OQ}		45	50	55	% V_{DD}
Sensitivity @ $T = +25^\circ\text{C}$	$S_{T=25}$	$T_A = +25^\circ\text{C}$	176	200	224	mV/V/mT
Sensitivity @ Full Temperature Range	S_{FULL_RANGE}	$T_A = -40^\circ\text{C to }+85^\circ\text{C}$	140	200	260	mV/V/mT

Typical Characteristics for CT834DR

$V_{DD} = 3.0\text{ V}$ and $T_A = +25^\circ\text{C}$, $C_{DD} = 1.0\ \mu\text{F}$ (unless otherwise specified).

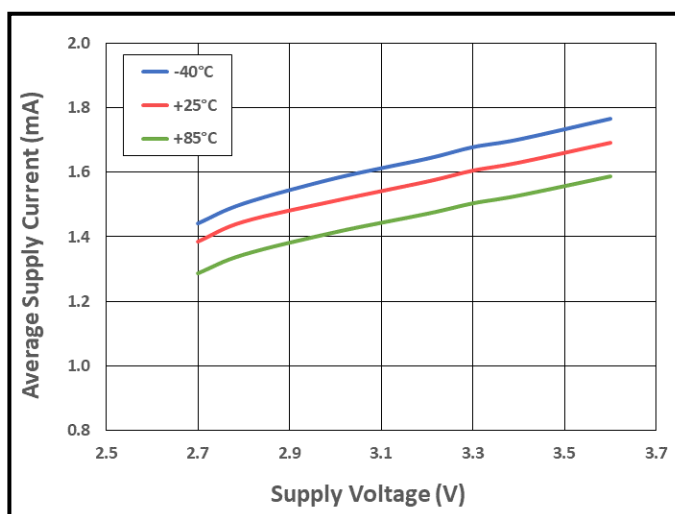

Figure 17. Average Supply Current vs. Supply Voltage vs. Temperature

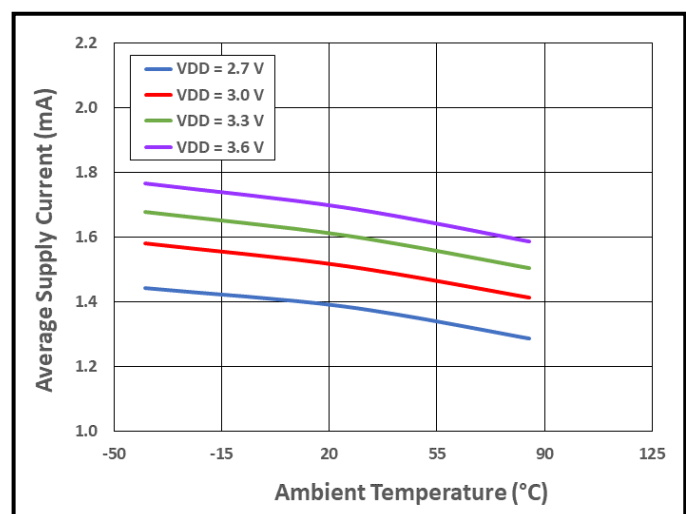

Figure 18. Average Supply Current vs. Temperature vs. Supply Voltage



Table 15: Electrical Characteristics for CT852AN

Unless otherwise specified: $V_{DD} = 2.7\text{ V to }3.6\text{ V}$, $T_A = -40^\circ\text{C to }+125^\circ\text{C}$. Typical values are $V_{DD} = 3.0\text{ V}$ and $T_A = +25^\circ\text{C}$.

Parameter	Symbol	Conditions	Min	Typ	Max	Unit
Average Supply Current	$I_{DD(AVG)}$	$t = 10\text{ s}$		1.7	3.3	μA
Sampling Frequency	f_S		325	500	600	Hz
Active Mode Time	t_{ACT}			1.4		μs
Idle Mode Time	t_{IDLE}			2.0		ms
Operate Point	B_{OPS}		0.8	1.0	1.4	mT
Release point	B_{RPN}		-1.4	-1.0	-0.8	mT

Typical Characteristics for CT852AN

$V_{DD} = 3.0\text{ V}$ and $T_A = +25^\circ\text{C}$, $C_{DD} = 1.0\text{ }\mu\text{F}$ (unless otherwise specified).

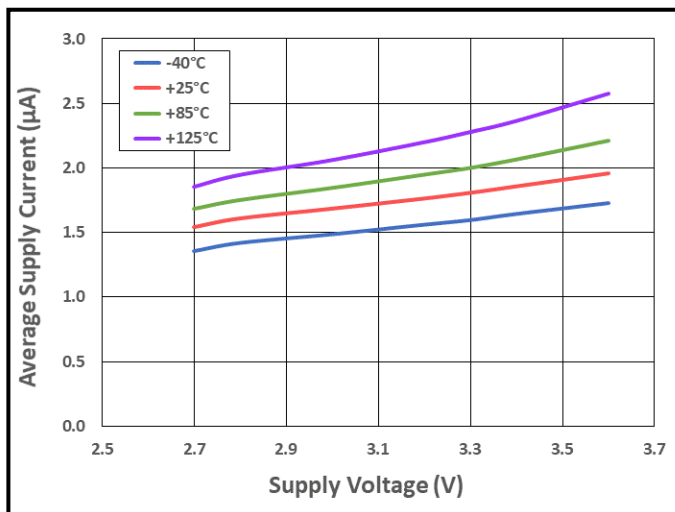

Figure 19. Average Supply Current vs. Supply Voltage vs. Temperature

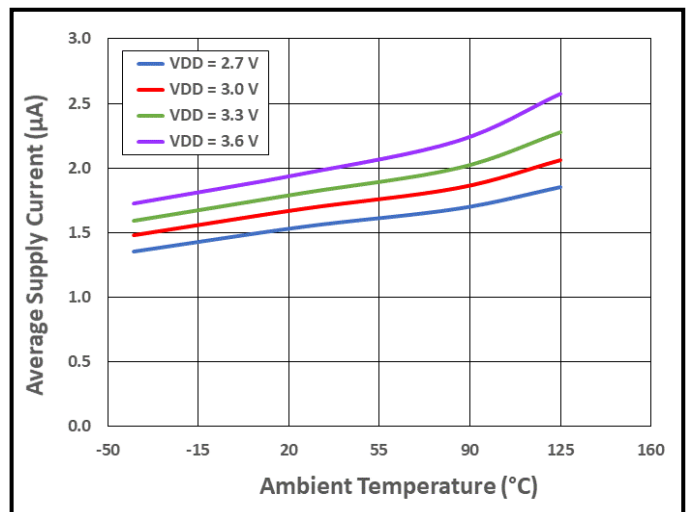

Figure 20. Average Supply Current vs. Temperature vs. Supply Voltage



Typical Characteristics for CT852AN

$V_{DD} = 3.0\text{ V}$ and $T_A = +25^\circ\text{C}$, $C_{DD} = 1.0\ \mu\text{F}$ (unless otherwise specified).

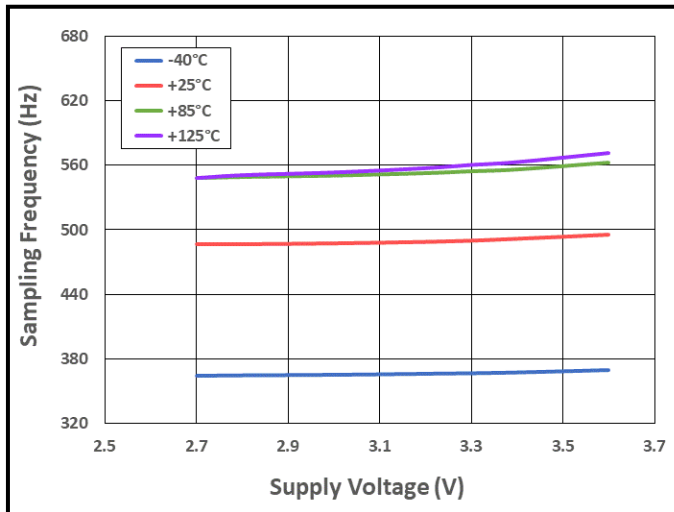
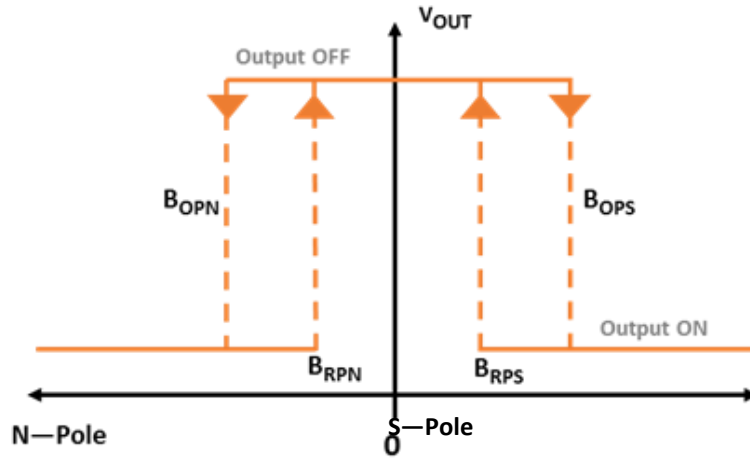

Figure 21. Sampling Frequency vs. Supply Voltage vs. Temperature



Figure 22: Omnipolar Magnetic Flux



Output Behavior versus Magnetic Field

Characteristic	Conditions	Output
South Pole	$B > B_{OPS}$	Low (ON)
	$0 < B < B_{RPS}$	High (OFF)
North Pole	$B < B_{OPN}$	Low (ON)
	$0 > B > B_{RPN}$	High (OFF)



Figure 23: Bipolar Magnetic Flux

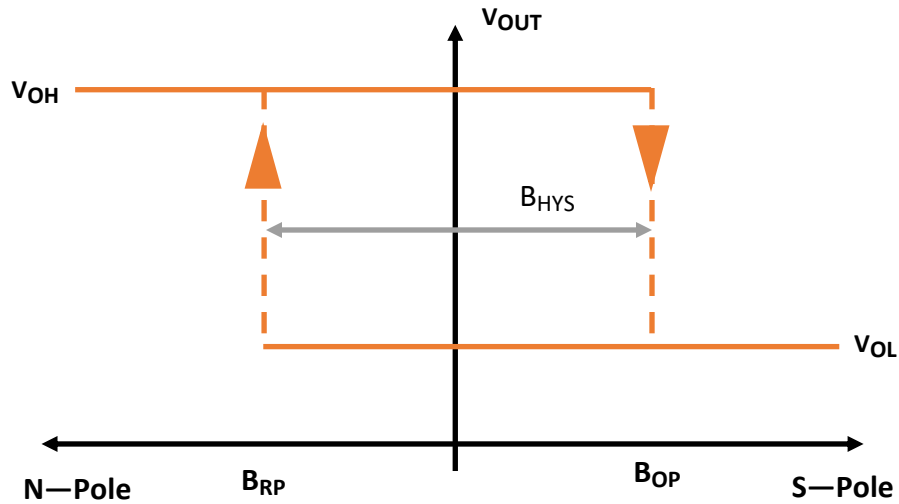

Output Behavior versus Magnetic Field

Characteristic	Conditions	Output
South Pole	$B > B_{OP}$	Low (ON)
North Pole	$B < B_{RP}$	High (OFF)



Figure 24: Application Circuits

A decoupling capacitor (C_{DD}) between the supply voltage and ground is required with placement close to the magnetic switch. A typical capacitor value of $1\ \mu\text{F}$ (Ceramic) will suffice. For the open drain output, maximum V_{SYS} should not exceed 5.5 V.

CT831 Open Drain Output

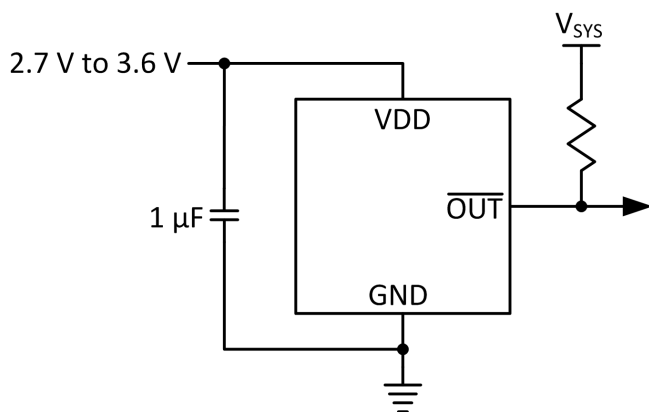

CT832 & CT852 Digital Output

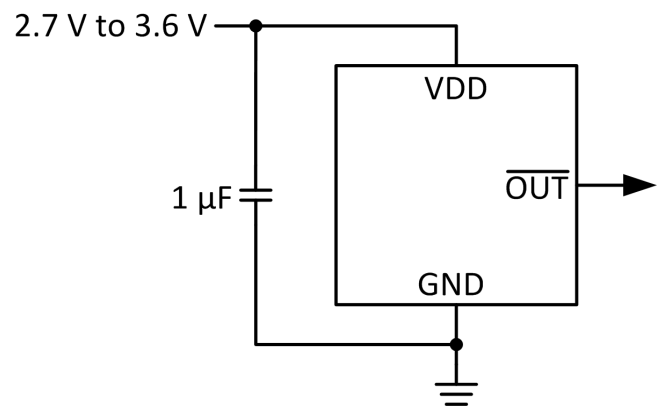

For the analog output, a simple RC filter is recommended on the ANA output as shown below:

CT834 Analog Output

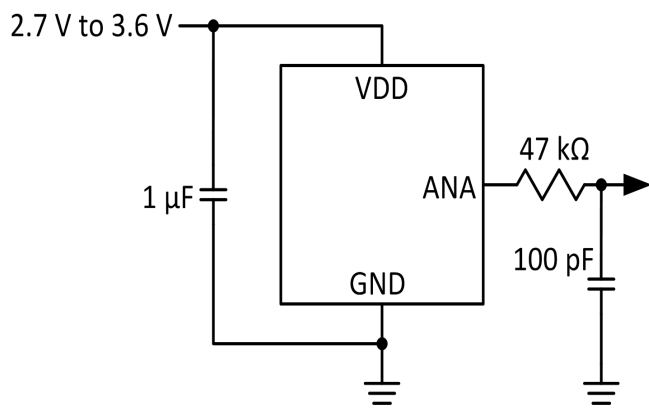
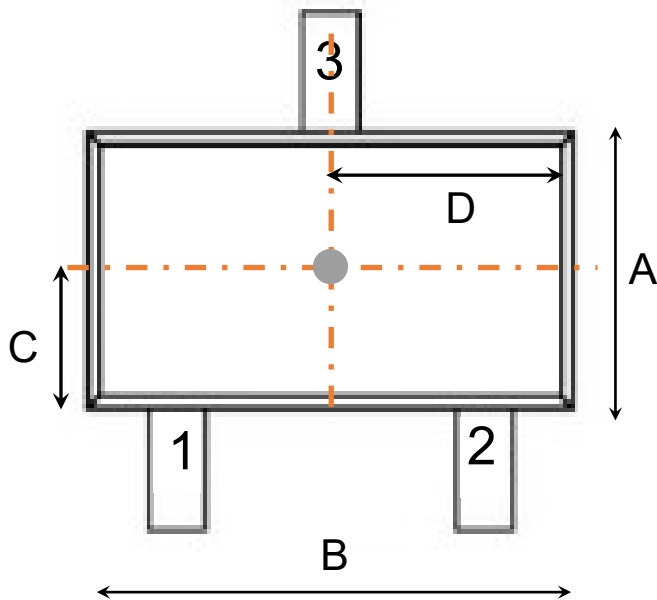
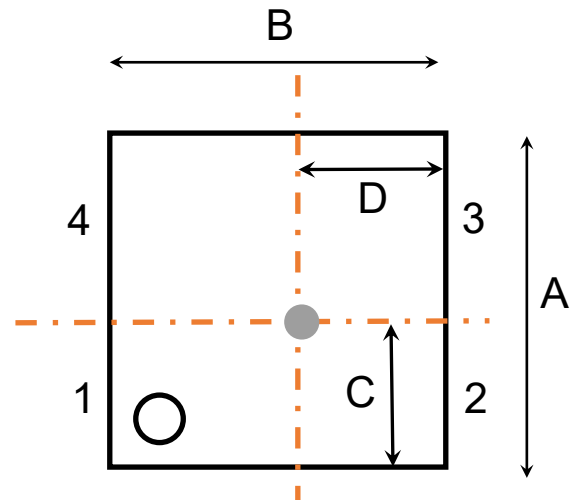



Figure 25: MLU Sensor Location



SOT23 Package



LGA Package

Symbols	Nominal Dimensions (mm)
A	1.60
B	2.90
C	0.80
D	1.45

Symbols	Nominal Dimensions (mm)
A	1.40
B	1.40
C	0.50
D	0.50



CT8xx Series

Digital TMR Latch for Consumer & Industrial Applications

Table 16: Order Guide

Part Number	Polarity	Output Type	B _{OP}	B _{RP}	I _{DD(AVG)}	f _S	Description
CT831BV-HS3	Omnipolar	Open Drain					Omnipolar Magnetic Latch SOT-23 Package, Tape & Reel Packaging
CT831BV-IS3							
CT832BV-HL1		Push-Pull	±3.0 mT	±2.0 mT	200 nA	2 Hz	Omnipolar Magnetic Latch LGA Package, Tape & Reel Packaging
CT832BV-IL1							
CT832BV-HS3							Omnipolar Magnetic Latch SOT-23 Package, Tape & Reel Packaging
CT832BV-IS3							
CT832SK-HS3			±0.9 mT	±0.5 mT	230 nA	10 Hz	Omnipolar Magnetic Latch SOT-23 Package, Tape & Reel Packaging
CT832SK-IS3							
CT832SL-HS3			±0.9 mT	±0.5 mT	1.4 µA	250 Hz	Omnipolar Magnetic Latch SOT-23 Package, Tape & Reel Packaging
CT832SL-IS3							
CT832BL-HS3			±3.0 mT	±2.0 mT	1.4 µA	250 Hz	Omnipolar Magnetic Latch SOT-23 Package, Tape & Reel Packaging
CT832BL-IS3							
CT832DM-HS3			±1.5 mT	±1.0 mT	12 µA	2.5 kHz	Omnipolar Magnetic Latch SOT-23 Package, Tape & Reel Packaging
CT832DM-IS3							
CT832BH-HL1			±3.0 mT	±2.0 mT	1.6 mA	10 kHz	Omnipolar Magnetic Latch LGA Package, Tape & Reel Packaging
CT832BH-IL1							
CT832EK-HS3			±7.0 mT	±5.0 mT	230 nA	10 Hz	Omnipolar Magnetic Latch SOT-23 Packages, Tape & Reel Packaging
CT832EK-IS3							
CT834DR-IL1		Analog	N/A	N/A	1.5 mA	Continuous	Omnipolar Magnetic Latch LGA Packages, Tape & Reel Packaging
CT834DR-IS3							Omnipolar Magnetic Latch SOT-23 Packages, Tape & Reel Packaging
CT852AN-HS3	Bipolar	Push-Pull	+1.0 mT	-1.0 mT	2.6 µA	500 Hz	Bipolar Magnetic Latch SOT-23 Package, Tape & Reel Packaging
CT852AN-IS3							



CT8xx Series

Digital TMR Latch for Consumer & Industrial Applications

Table 17. Packaging Information

Orderable Part Number	Package Type	Pins	Package Quantity	Lead Finish	Eco Plan ⁽¹⁾	MSL Rating ⁽²⁾	Operating Temperature	Device Marking ⁽³⁾
CT831BV-HS3	SOT-23	3	3,000	Sn	Green & RoHS	1	-40°C to +125°C	JA YWWS
CT831BV-IS3	SOT-23	3	3,000	Sn	Green & RoHS	1	-40°C to +85°C	JA YWWS
CT832BV-HL1	LGA	4	3,000	Au	Green & RoHS	3	-40°C to +125°C	A YZ
CT832BV-IL1	LGA	4	3,000	Au	Green & RoHS	3	-40°C to +85°C	A YZ
CT832BV-HS3	SOT-23	3	3,000	Sn	Green & RoHS	1	-40°C to +125°C	HA YWWS
CT832BV-IS3	SOT-23	3	3,000	Sn	Green & RoHS	1	-40°C to +85°C	HA YWWS
CT832SK-HS3	SOT-23	3	3,000	Sn	Green & RoHS	1	-40°C to +125°C	HC YWWS
CT832SK-IS3	SOT-23	3	3,000	Sn	Green & RoHS	1	-40°C to +85°C	HC YWWS
CT832SL-HS3	SOT-23	3	3,000	Sn	Green & RoHS	1	-40°C to +125°C	HE YWWS
CT832SL-IS3	SOT-23	3	3,000	Sn	Green & RoHS	1	-40°C to +85°C	HE YWWS
CT832BL-HS3	SOT-23	3	3,000	Sn	Green & RoHS	1	-40°C to +125°C	HB YWWS
CT832BL-IS3	SOT-23	3	3,000	Sn	Green & RoHS	1	-40°C to +85°C	HB YWWS
CT832DM-HS3	SOT-23	3	3,000	Sn	Green & RoHS	1	-40°C to +125°C	HD YWWS
CT832DM-IS3	SOT-23	3	3,000	Sn	Green & RoHS	1	-40°C to +85°C	HD YWWS
CT832BH-HL1	LGA	4	3,000	Au	Green & RoHS	3	-40°C to +125°C	E YZ
CT832BH-IL1	LGA	4	3,000	Au	Green & RoHS	3	-40°C to +85°C	E YZ
CT832EK-HS3	SOT-23	3	3,000	Sn	Green & RoHS	1	-40°C to +125°C	HF YWWS
CT832EK-IS3	SOT-23	3	3,000	Sn	Green & RoHS	1	-40°C to +85°C	HF YWWS
CT834DR-IL1	LGA	4	3,000	Au	Green & RoHS	3	-40°C to +85°C	D YZ
CT834DR-IS3	SOT-23	3	3,000	Sn	Green & RoHS	1	-40°C to +85°C	HT YWWS
CT852AN-HS3	SOT-23	3	3,000	Sn	Green & RoHS	1	-40°C to +125°C	HS YWWS
CT852AN-IS3	SOT-23	3	3,000	Sn	Green & RoHS	1	-40°C to +85°C	HS YWWS

(1) RoHS is defined as semiconductor products that are compliant to the current EU RoHS requirements. It also will meet the requirement that RoHS substances do not exceed 0.1% by weight in homogeneous materials. Green is defined as the content of Chlorine (Cl), Bromine (Br) and Antimony Trioxide based flame retardants satisfy JS709B low halogen requirements of $\leq 1,000$ ppm.

(2) MSL Rating = Moisture Sensitivity Level Rating as defined by JEDEC industry standard classifications.

(3) Device Marking for SOT23 is defined as XZ YWWS where XZ = part number, Y = year, WW = work week and S = sequential number. LGA is defined as X where X = part number and YZ = date code information.



CT8xx Series

Digital TMR Latch
for Consumer & Industrial
Applications

Figure 26: 3-Lead SOT-23 Package Dimensions

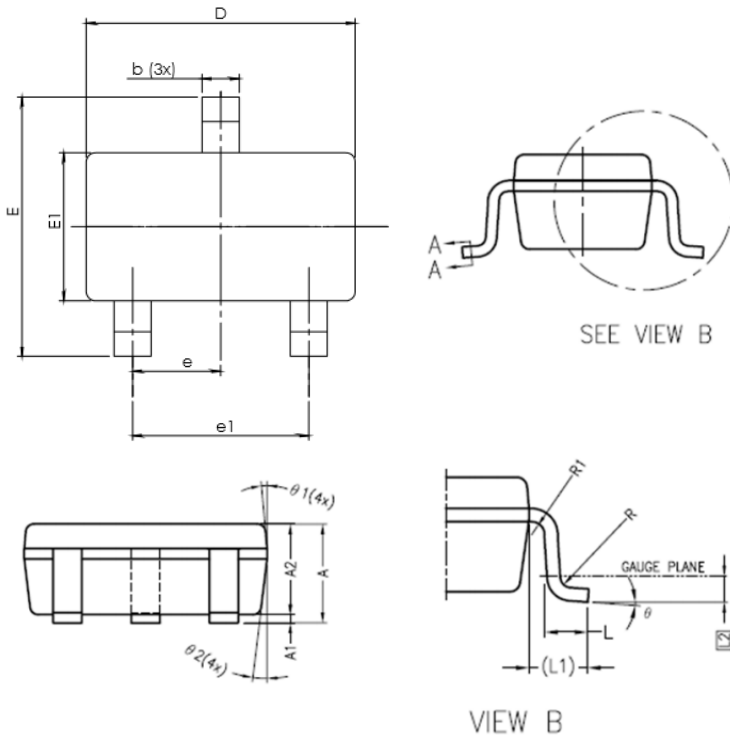

SYMBOLS	DIMENSIONS IN MILLIMETERS		
	MIN	NOM	MAX
A	1.05	1.20	1.35
A1	0.00	0.10	0.15
A2	1.00	1.10	1.20
b	0.30	—	0.50
b1	0.30	0.35	0.45
c	0.08	—	0.22
c1	0.08	0.13	0.20
D	2.80	2.90	3.00
E	2.60	2.80	3.00
E1	1.50	1.60	1.70
e	0.95 BSC		
e1	1.90 BSC		
L	0.35	0.43	0.60
L1	0.60 REF		
L2	0.25 BSC.		
R	0.10	—	—
R1	0.10	—	0.25
θ	0°	4°	8°
θ1	5°	6°	15°
θ2	5°	8°	15°



CT8xx Series

Digital TMR Latch
for Consumer & Industrial
Applications

Figure 27: 4-Lead LGA Package Dimensions

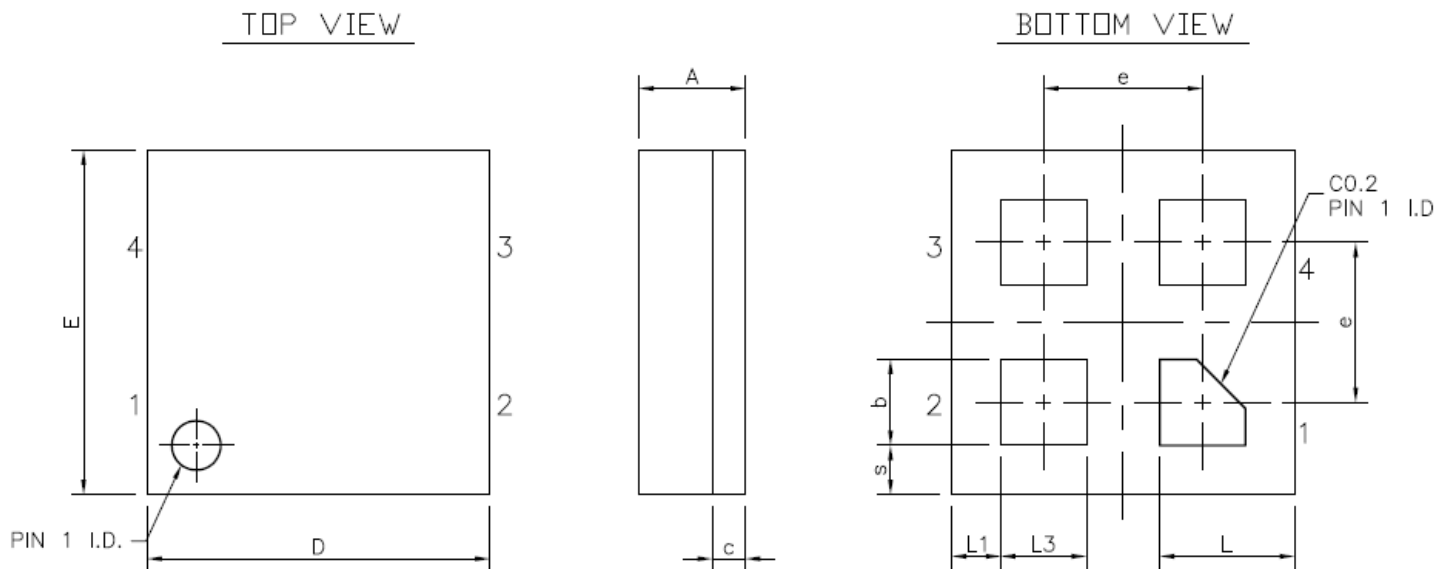

NOTE: ALL DIMENSIONS ARE IN MILLIMETERS.

SYMBOLS	DIMENSIONS IN MILLIMETERS		
	MIN.	NOM.	MAX.
A	0.386	0.436	0.486
b	0.30	0.35	0.40
c	---	0.136 REF.	---
D	1.35	1.40	1.45
E	1.35	1.40	1.45
e	---	0.65	---
L	0.50	0.55	0.60
L1	0.15	0.20	0.25
L3	0.30	0.35	0.40
s	0.15	0.20	0.25



CROCUS TECHNOLOGY
Intelligence in Sensing™

CT8xx Series

Digital TMR Latch for Consumer & Industrial Applications

Disclaimer: The contents of this document are provided for informational purposes only. CROCUS TECHNOLOGY, INC. AND CROCUS TECHNOLOGY SA (COLLECTIVELY "CROCUS") MAKE NO REPRESENTATIONS OR WARRANTY OF ANY KIND, EXPRESS OR IMPLIED, WITH RESPECT TO THE ACCURACY OR COMPLETENESS OF THE CONTENTS HEREIN, INCLUDING, BUT NOT LIMITED TO, THE IMPLIED WARRANTIES OF MERCHANTABILITY AND FITNESS FOR A PARTICULAR PURPOSE. Crocus reserves the right to make changes to the specifications and product descriptions, and/or to discontinue or make changes to its products at any time without notice. Crocus's products have not been designed, tested, or manufactured for use and should not be used in applications where the failure, malfunction or inaccuracy of the Products carries a risk of death or serious bodily injury or damage to tangible property, including, but not limited to, life support systems, nuclear facilities, military, aircraft navigation or communication, emergency systems, harsh environments, or other applications with a similar degree of potential hazard.

© 2017 Crocus Technology, Inc. and Crocus Technology SA. All rights reserved. Crocus Technology, Intelligence in Sensing, MLU, and combinations thereof are trademarks of Crocus Technology, Inc. and Crocus Technology SA.

X-ON Electronics

Largest Supplier of Electrical and Electronic Components

Click to view similar products for [Board Mount Hall Effect/Magnetic Sensors](#) category:

Click to view products by [Crocus](#) manufacturer:

Other Similar products are found below :

[ACHS-7194-500E](#) [ACHS-7193-500E](#) [ACHS-7193-000E](#) [ACHS-7194-000E](#) [G-MRCO-017](#) [A1104LUA-T](#) [A1212LUA-T](#) [HGPRDT005A](#)
[AH1808-P-A](#) [AH277AZ4-AG1](#) [AH373-WG-7](#) [AV-10379](#) [AV-10448](#) [A1211LUA-T](#) [SS41C](#) [AH1803-WG-7](#) [AH1806-P-B](#) [AH1894-Z-7](#)
[MA700GQ-P](#) [ATS601LSGTN-HT-WU4-T](#) [ATS601LSGTN-LT-WU4-T](#) [TLE4917](#) [TLE4946-1L](#) [50017859-003](#) [TY-13101](#) [TLE4976L](#)
[AH1751-WG-7-A](#) [SS85CA](#) [BU52002GUL-E2](#) [MAX13366GTE/V+](#) [A1128LUA-T](#) [AH173-WG-7-B](#) [MA702GQ-P](#) [BU52003GUL-E2](#)
[AH277AZ4-BG1](#) [TLE49614MXTSA1](#) [AH3376-P-B](#) [TLE4941](#) [AH3382-P-B](#) [AH3372-W-7](#) [AH9250-W-7](#) [AH211Z4-AG1](#) [AH9251-W-7](#)
[TLE4905L](#) [AH3373-W-7](#) [AH3377-W-7](#) [AH3360-FT4-7](#) [AH3376-W-7](#) [TLE4961-3M](#) [AS5601-ASOT](#)