

PRODUCT NUMBER  
10136353-XXXXLX

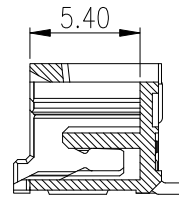

SECTION A-A

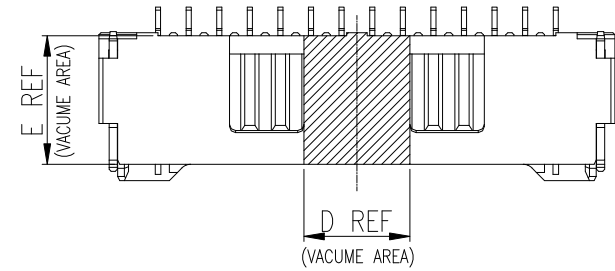
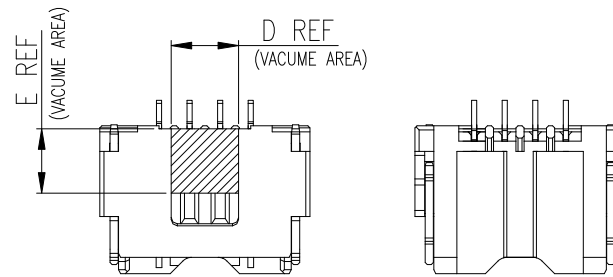
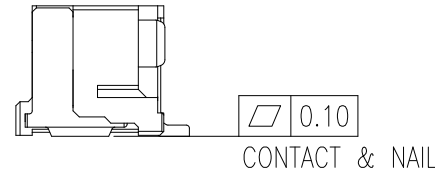
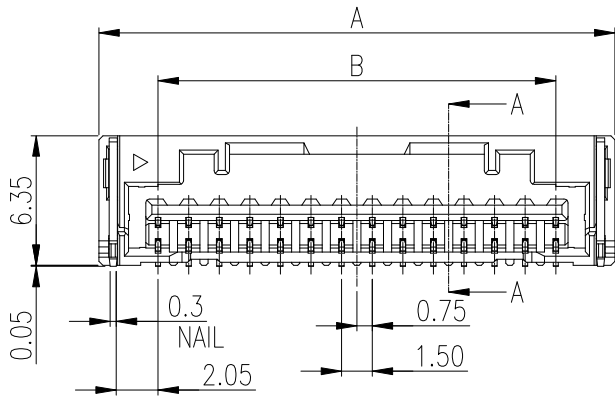

2PIN~5PIN

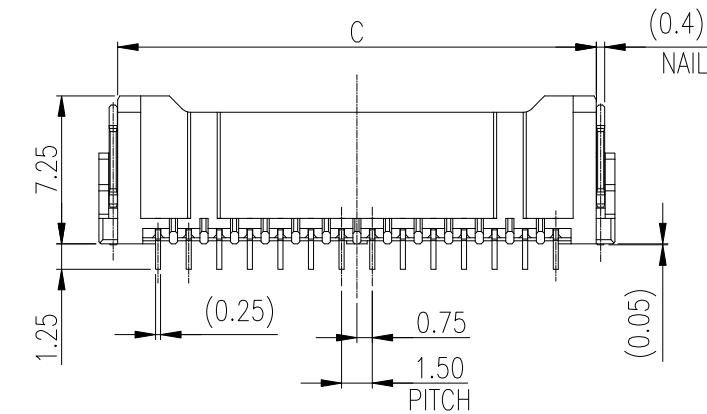

NOTE:

- MATERIAL SPECIFICATION:
    - INSULATION: HIGH TEMP. THERMOPLASTIC, UL 94V-0.
    - CONTACT: COPPER ALLOY
    - NAIL: COPPER ALLOY
  - FINISH SPECIFICATION:
    - CONTACT: Ni UNDERPLATE. SEE P/N FOR PLATING ON CONTACT AREA AND TAILS.
    - NAIL: TIN PLATE OVER Ni UNDERPLATE.
  - RoHS & HF COMPLIANCE
  - PART NO SCHEME:  
10136353- XX X X X LF
- No. OF POS.: 02~15
- HSG COLOR: 1: NATURAL
- PLATING: 1: TIN
- PACKAGE: 1: TAPE AND REEL

- THE CONNECTOR MATES WITH FCI WIRE CONNECTOR, HSG 10135175 AND CRIMPED TERMINAL 10135176
- THE HOUSING WILL WITHSTAND EXPOSURE TO 260°C PEAK TEMPERATURE 10 SEC. IN A CONVECTION REFLOW OVEN.
- PRODUCT SPECIFICATION: GS-12-1321
- PACKAGE SPECIFICATION: GS-14-2471
- DIMENSIONAL TABLE:

Pos.	A	B	C	D	E
02	7.30	—	5.5	2.3	2.9
03	8.80	3.00	7.0	2.55	2.9
04	10.30	4.50	8.5	3.3	2.9
05	11.80	6.00	10.0	3.6	2.9
06	13.30	7.50	11.5	2.3	6.0
07	14.80	9.00	13.0	2.5	6.0
08	16.30	10.50	14.5	2.5	6.0
09	17.80	12.00	16.0	3.2	6.0
10	19.30	13.50	17.5	3.2	6.0
11	20.80	15.00	19.0	5.2	6.0
12	22.30	16.50	20.5	5.2	6.0
13	23.80	18.00	22.0	5.2	6.0
14	25.30	19.50	23.5	5.2	6.0
15	26.80	21.00	25.0	5.2	6.0

mat'l. code		surface		tolerance	projection	product family		
ltr		ecn no	dr	date	tolerances unless otherwise specified		MINITEK 1.5mm WTB	
A		TAI		2015-08-05	angles	X.X±0.3	title	
					linear	X.XX±0.20		
					±2'	X.XXX±0.100	MINITEK 1.5mm, RECEPTACLE	
					dr	KENNY TAI	2015-07-31	CONNECTOR, RIGHT ANGLE, SMT
					enr	KENNY TAI	2015-07-31	scale
					chr	KENNY TAI	2015-07-31	dwg no
					appd	PM ZHENG	2015-08-05	
sheet index	revision sheet	A	A	1	2	sheet 1 of 2		size
						10136353		A4
						type		CUSTOMER Drawing

PRODUCT NUMBER  
10136353-XXXXXLF

CIRCUIT No.1

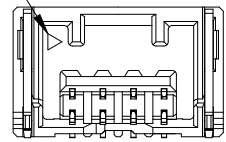

2PIN~5PIN

CIRCUIT No.1

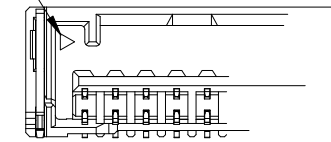

6P~11P

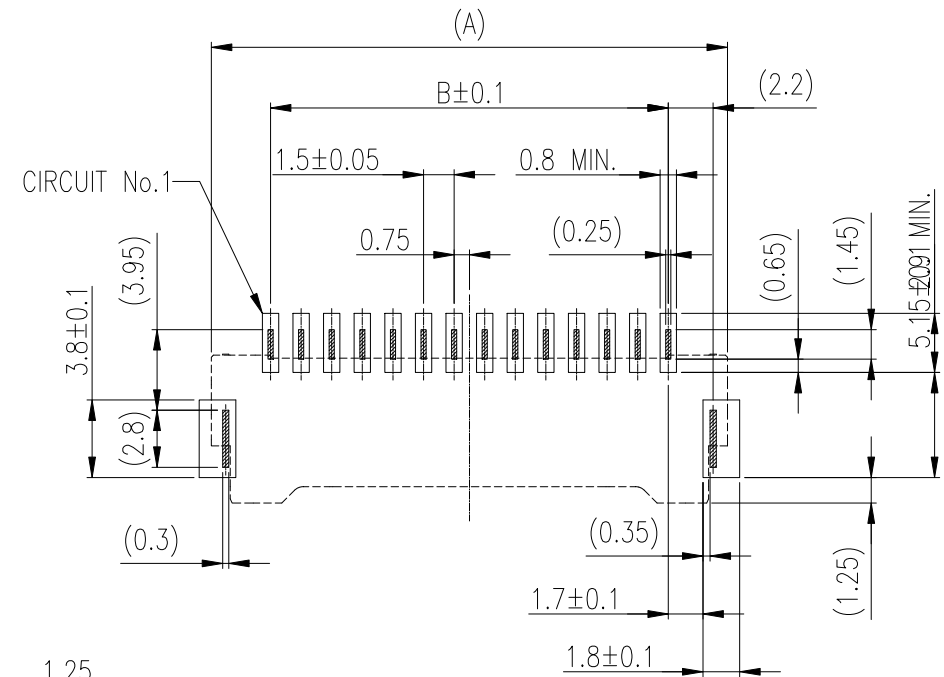

RECOMMENDED P.C.B LAYOUT  
GENERAL TOLERANCE ±0.05

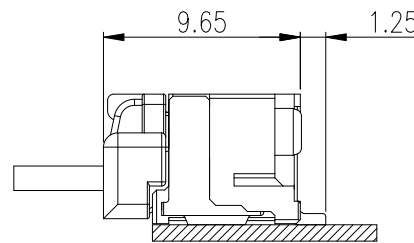
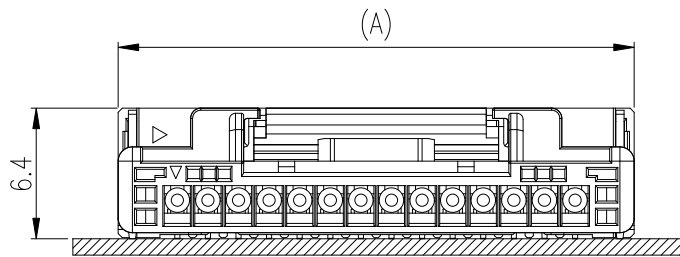

MATED CONNECTORS

mat'l. code		surface		tolerance	projection	product family	
ltr		ecn	no	dr	date	MINITEK 1.5mm WTB	
		tolerances unless otherwise specified		angles		title	
		linear		±2'		MINITEK 1.5mm, RECEPTACLE	
		X.X±0.3		linear		CONNECTOR, RIGHT ANGLE, SMT	
		X.XX±0.20		scale		dwg no	
		X.XXX±0.100		mm		sheet 2 of 2	
dr		KENNY TAI		2015-07-31		size	
enr		KENNY TAI		2015-07-31		A4	
chr		KENNY TAI		2015-07-31		10136353	
appd		PM ZHENG		2015-08-05		type	
						CUSTOMER Drawing	
sheet index	revision sheet	A	A	1	2		

## X-ON Electronics

Largest Supplier of Electrical and Electronic Components

*Click to view similar products for [Headers & Wire Housings](#) category:*

*Click to view products by [Amphenol](#) manufacturer:*

Other Similar products are found below :

[95000-104TRLF](#) [10135584-644402LF](#) [DF62W-EP2022PCA](#) [95000-106TRLF](#) [DF62W-2022SCA](#) [DF62W-EP2022PC](#) [2203348](#) [DF62W-2022SC](#) [1084018](#) [1029039](#) [1084017](#) [802-10-012-10-002000](#) [1112640](#) [1112639](#) [891-007-9SS-BST1T](#) [000-34000](#) [0008550134](#) [0009482033](#) [0009507031](#) [57102-F02-18ULF](#) [57102-S06-03LF](#) [57202-S52-04LF](#) [PCN6-15S-2.5E](#) [0039019024](#) [58102-G61-06LF](#) [582553-1](#) [0009485154](#) [0009508121](#) [009176003701906](#) [0022285053](#) [0050291907](#) [018731A](#) [LY20-4P-DT1-P1E-BR](#) [02.125.8002.8](#) [60101931](#) [60598-1 \(Cut Strip\)](#) [M1625-3R/100](#) [61062-3](#) [61082-181009](#) [CSU011177004](#) [636-1427](#) [638009-1](#) [641938-9](#) [641991-4](#) [644168-1](#) [644827-2](#) [647662-1](#) [65039-019ELF](#) [65692-001LF](#) [65781-018](#)