

BN 762 - DIN 127 B

Helical spring lock washers
with flat end

DIN 127 B
~UNI 1751 B

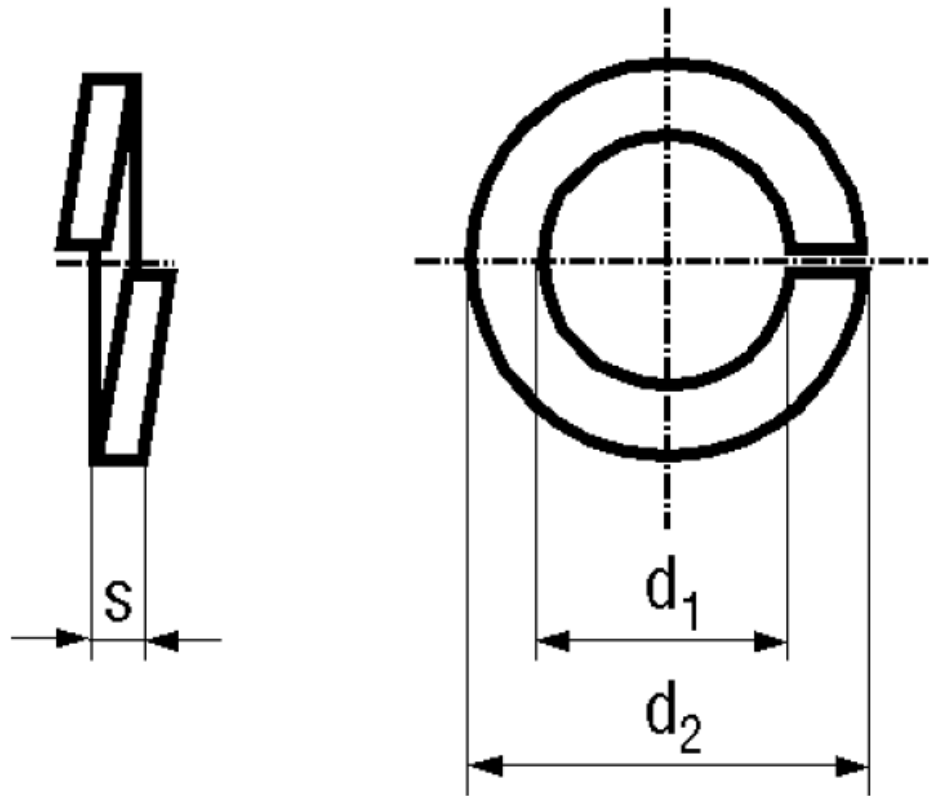

Material	Spring steel	Hardness	HV 430-530
Surface	mechanical zinc plated blue		

Article No. - 1275623

for thread	M3
d_1 min.	3,1
d_1 max.	3,4
d_2 max.	6,2
s	0,8

DIN 127: This standard has been definitively abolished. We recommend DIN 128 (curved spring lock washers) for new constructions.

Alternative:

Depending on the technical manufacturing possibilities, spring steel elements are equally available with an inorganic or mechanical zinc-plating (availability, prices and delivery periods on request). These procedures exclude the risk of varied breakage due to hydrogen brittleness, his being liable to appear in acid baths or during electroplating (zinc-plating).

Not included in DIN 127.

X-ON Electronics

Largest Supplier of Electrical and Electronic Components

Click to view similar products for [Screws & Fasteners](#) category:

Click to view products by [Bossard](#) manufacturer:

Other Similar products are found below :

[5721-1440-1/4-SS](#) [593503FX](#) [0098.0094](#) [0098.9206](#) [0098.9219](#) [0098.9221](#) [0098.9262](#) [596-2114-013](#) [59781-4](#) [59781-6](#) [0098.0026](#)
[0098.9210](#) [0098.9212](#) [60227-01](#) [60227-04](#) [60227-08](#) [60228-09](#) [618-00001](#) [62153-03](#) [62153-11](#) [M316-KSSTMCZ100](#) [M3440-SS](#) [M3442-SS](#) [M3448-SS](#) [6291A](#) [6292-1](#) [6-306105-9](#) [6-306131-4](#) [690432-1](#) [699161-000](#) [700989](#) [7-18023-1](#) [7-21002-8](#) [7230-3](#) [7235-3](#) [7248-1](#) [7248-2](#)
[73542-02](#) [CAPTIVE SHORT THUMBSCREW](#) [745564-1](#) [748174-2](#) [F03-02](#) [SUS316](#) [F1209](#) [751-00001](#) [80011](#) [809704-1](#) [8700](#) [8860220](#)
[9047](#) [95000002B](#) [9885-2](#)