

SM7221, SM7321, SM7421 Series Gauge & Differential Pressure Sensors

FEATURES

- Pressure ranges from 0.15 to 0.29 psi; gauge, differential and asymmetric outputs
- Accuracy: $\pm 1\%$ full scale
- 14-bit digital, pressure calibrated and temperature compensated output
- I²C Digital Interface
- Compensated temperature range: -20 to 85°C
- Insensitive to mounting orientation
- Robust JEDEC SOIC-16 package for automated assembly
- Manufactured according to ISO9001 and ISO/TS 16949 standards



DESCRIPTION

The SM7221, SM7321 & SM7421 series is a digital, low pressure MEMS sensor family offering state-of-the-art pressure transducer technology and CMOS mixed signal processing technology to produce a digital, fully conditioned, multi-order pressure and temperature compensated sensor in JEDEC standard SOIC-16 package with a dual vertical porting option. It is available in both compound gage or differential pressure configurations. With the dual porting, a vacuum-gage measurement is possible to minimize altitude errors due to changes in ambient pressure.

Combining the pressure sensor with a signal-conditioning ASIC in a single package simplifies the use of advanced silicon micro-machined pressure sensors. The pressure sensor can be mounted directly on a standard printed circuit board and a high level, calibrated pressure signal can be acquired from the digital interface. This eliminates the need for additional circuitry, such as a compensation network or microcontroller containing a custom correction algorithm.

Customer-specified pressure ranges and supply voltages are available.

The SM7221, SM7321 & SM7421 series is shipped in sticks or tape & reel.

Medical	Industrial	Consumer
Sleep Apnea	Airflow Measurement	Sports Equipment
CPAP	Pneumatic Gauges	Appliances
Ventilators	Pressure Switches	
Gas Flow Instrumentation	Safety Cabinets	
Air Flow Monitors	Life Sciences	
Negative Pressure Wound Therapy	Gas Flow Instrumentation	

Absolute Maximum Ratings

All parameters are specified at Vdd = 3.3 V supply voltage at 25°C, unless otherwise noted.

No.	Characteristic	Symbol	Minimum	Typical	Maximum	Units
1	Supply Voltage	V _{DD}	2.7		6.00	V
2	Supply Current	I _{VDD}		2.00	4.00	mA
3	Update Period				2	ms
4	Compensated Temperature		-20		+85	°C
5	Operating Temperature ^(a)	T _{OP}	-40		+105	°C
6	Storage Temperature ^(a)	T _{STG}	-40	-	+125	°C
7	Proof Pressure ^(a, b)	P _{Proof}			1.4	psi
8	Burst Pressure ^(a, c)	P _{Burst}			2.8	psi

Notes:

- a. Tested on a sample basis.
- b. Proof pressure is defined as the maximum pressure to which the device can be taken and still perform within specifications after returning to the operating pressure range
- c. Burst pressure is the pressure at which the device suffers catastrophic failure resulting in pressure loss through the device.

OPERATING CHARACTERISTICS TABLE

All parameters are specified at V_{DD} = 3.3 V DC supply voltage at 25°C, unless otherwise noted.

No.	Characteristic	Symbol	Minimum	Typical	Maximum	Units
9	Supply Voltage*	V _{DD}	3.0	3.3	3.6	V
			4.75	5.0	5.25	
10	Pressure Output @ P _{MIN}	OUT _{MIN}		1,638		Counts
11	Pressure Output @ P _{MAX}	OUT _{MAX}		14,745		Counts
12	Full Scale Span	FSP		13,107		Counts
13	Resolution			14		Bits
14	Accuracy ^(e, f, g)	ACC	- 1		+1	%FS

Calibrated Pressure Ranges				
No.	Device Type	P _{MIN} (psi)	P _{MAX} (psi)	Comment
15	SM7221 – Gauge	0	+0.15 to +0.29	
16	SM7321 – Differential	-0.29 to -0.15	+0.15 to +0.29	Absolute value of P _{MIN} must match absolute value of P _{MAX}
17	SM7421 – Asymmetric	-0.29 to 0	0 to +0.29	Delta between P _{MIN} and P _{MAX} must be at least 0.15 psi

Notes:

- e. The accuracy specification applies over all operating conditions. This specification includes the combination of linearity, repeatability, and hysteresis errors over pressure, temperature, and voltage.
- f. Maximum 10-year zero pressure offset shift < ±2%FS based on 1000 hours of HTOL , TC and THB testing.
- g. For less demanding applications, devices with relaxed accuracy specifications are available

***Custom calibration pressures and voltages are available to meet specific customer demands.**

Media Compatibility - Clean, dry gas compatible with wetted materials. Wetted materials include silicon, epoxy, RTV, gold and aluminum.

SM7X21 Series – I²C Communications

1. SCL Clock frequency:

- 100kHz to 400kHz

2. Slave Address

- The factory setting for the I²C slave address is 28HEX. The part will only respond to the set address.

3. Read Operations

- For read operations, the I²C master command starts with the 7-bit slave address with the 8th bit = 1 (READ). The sensor as the slave sends an acknowledge (ACK) indicating success.
- The sensor has four I²C read commands: Read_DF2, Read_DF3, and Read_DF4. The following figures show the structure of the measurement packet for three of the four I²C read commands, which are further explained below.

3.1 I²C Read_DF (Data Fetch):

- For the Data Fetch commands, the number of data bytes returned by the sensor is determined by when the master sends the NACK and stop condition.

- For the Read_DF3 data fetch command (Data Fetch 3 Bytes), the sensor returns three bytes in response to the master sending the slave address and the READ bit (1): two bytes of bridge data with the two status bits as the MSBs and then 1 byte of temperature data (8-bit accuracy). After receiving the required number of data bytes, the master sends the NACK and stop condition to terminate the read operation.
- For the Read_DF4 command, the master delays sending the NACK and continues reading an additional final byte to acquire the full corrected 11-bit temperature measurement. In this case, the last 5 bits of the final byte of the packet are undetermined and should be masked off in the application.
- The Read_DF2 command is used if corrected temperature is not required. The master terminates the READ operation after the two bytes of bridge data.

- I2C Read_DF2 – Data Fetch 2 Bytes:
 - Slave returns only pressure data to the master in 2 bytes.
 - Start Condition – Device Slave Address [6:0] – Read/Write Bit (Read = 1) – Wait for Slave ACK – 2 status bits – 6 pressure bits [13:8] – Master ACK – 8 pressure bits [7:0] – Master NACK – Stop Condition

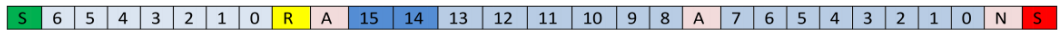

- I2C Read_DF3 – Data Fetch 3 Bytes:
 - Slave returns 2 pressure data bytes and temperature high byte [10:3] to the master.
 - Start Condition – Device Slave Address [6:0] – Read/Write Bit (Read = 1) – Wait for Slave ACK – 2 status bits – 6 pressure bits [13:8] – Master ACK – 8 pressure bits [7:0] – Master ACK – 8 temperature bits [10:3] – Master NACK – Stop Condition

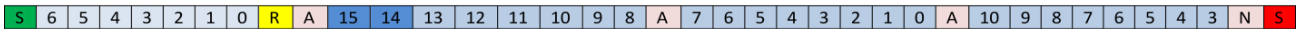

- I2C Read_DF4 – Data Fetch 4 Bytes:
 - Slave returns 2 pressure data bytes and 2 temperature bytes ([10:3] and [2:0]xxxx) to the master.
 - Start Condition – Device Slave Address [6:0] – Read/Write Bit (Read = 1) – Wait for Slave ACK – 2 status bits – 6 pressure bits [13:8] – Master ACK – 8 pressure bits [7:0] – Master ACK – 8 temperature bits [10:3] – Master ACK – 3 temperature bits [2:0] – Master NACK – Stop Condition



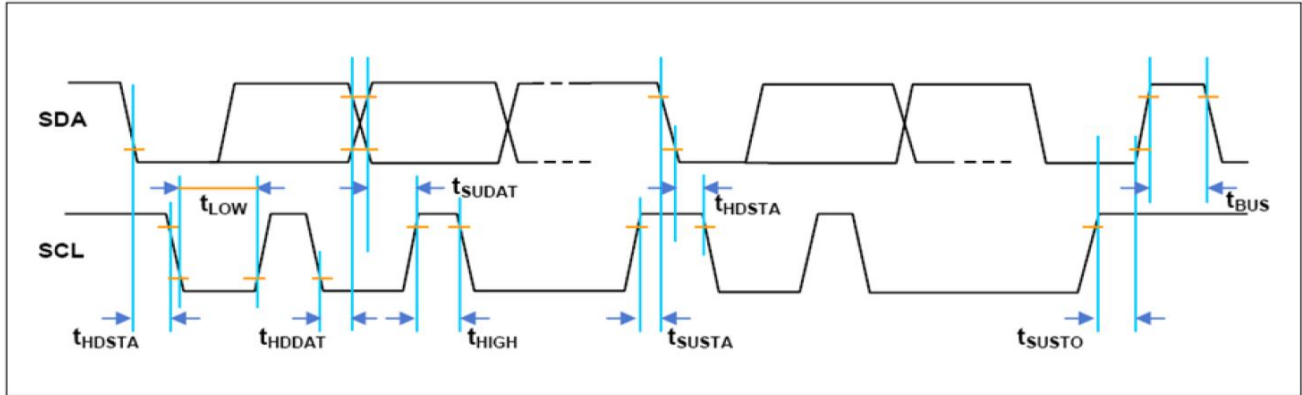

Parameter	Symbol	Minimum	Typical	Maximum	Units
SCL Clock Frequency	F _{SCL}	100		400	kHz
Start Condition Hold Time Relative to SCL Edge	t_{HDSTA}	0.1			μ s
Minimum SCL Clock Low Width ¹	t_{LOW}	0.6			μ s
Minimum SCL Clock High Width ¹	t_{HIGH}	0.6			μ s
Start Condition Hold Time Relative to SCL Edge	t_{SUSTA}	0.1			μ s
Data Hold Time on SDA Relative to SCL Edge	t_{HDDAT}	0.0			μ s
Data Setup Time on SDA Relative to SCL Edge	t_{SUDAT}	0.1			μ s
Stop Condition Setup Time on SCL	t_{SUSTO}	0.1			μ s
Bus Free Time Between Stop Condition and Start Condition	t_{BUS}	2.0			μ s

5. Differences sensor I²C Protocol vs. Original I²C protocol

- **Note: There are three differences in the sensor protocol compared with the original I²C protocol**
- Sending a start-stop condition without any transitions on the CLK line (no clock pulses in between) created a communication error for the next communication, even if the next start condition is correct and the clock pulse is applied. An additional start condition must be sent, which results in restoration of proper communication.
- The restart condition - a falling SDA edge during data transmission when the CLK clock line is still high - creates the same situation. The next communication fails, and an additional start condition must be sent for correct communication.
- A failing SDA edge is not allowed between the start condition and the first rising SCL edge. If using an I²C address with the first bit 0, SDA must be held low from the start condition through the first bit.

6. Diagnostic Features – Status Bits

The sensor offers diagnostic features to ensure robust system operation. The diagnostic states are indicated by a transmission of the status of the 2 MSBs of the pressure high byte data.

Status Bits (2 MSBs of Output Packet)	Symbol
00	Normal operation, good data packet
01	Device in Command Mode (not applicable for normal operation)
10 ⁽¹⁾	Stale data: Data that has already been fetched since the last measurement cycle
11	Diagnostic condition exists

Note⁽¹⁾: If a data fetch is performed before or during the first measurement after power-on reset, then “stale” will be returned, but this data is actually invalid because the first measurement has not been completed.

- When the two MSBs are 11, one of the following faults listed below is indicated:
 - Invalid EEPROM signature
 - Loss of bridge positive or negative
 - Bridge input short
 - Loss of bridge source
- All diagnostics are detected in the next measurement cycle and reported in the subsequent data fetch. Once a diagnostic is reported, the diagnostic status bits will not change unless both the cause of the diagnostic is fixed and a power-on-reset is performed.

SOIC-16 (C) Vertical Package Dimensions

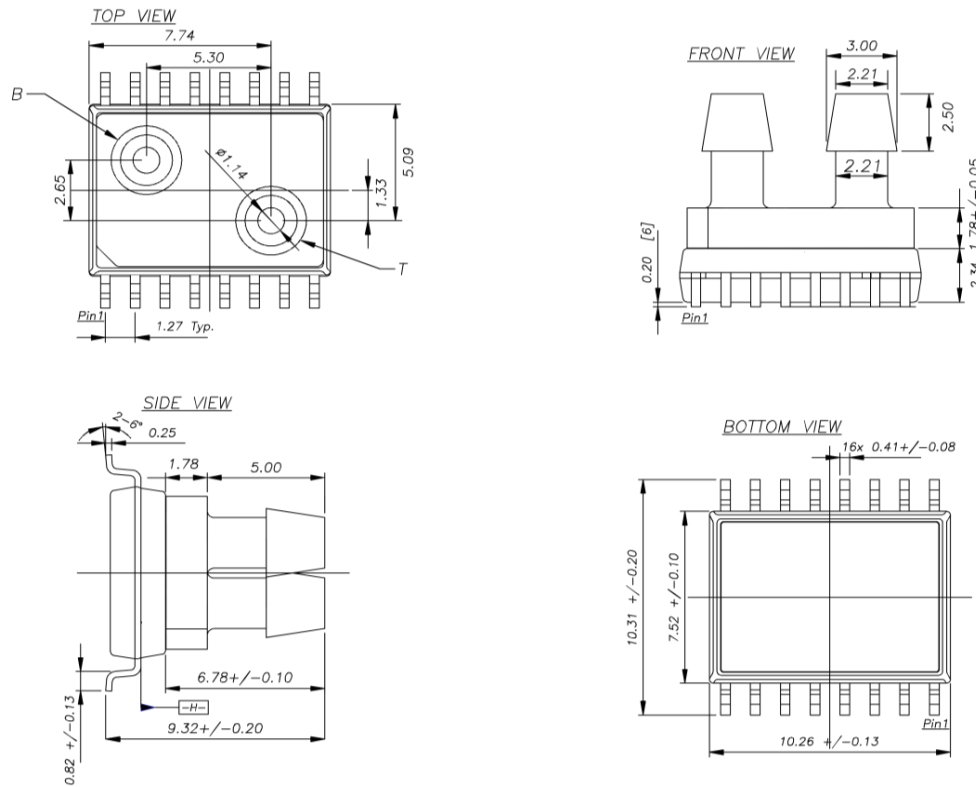

Notes:

- All dimensions in units of [mm]
- Moisture Sensitivity Level (MSL): Level 3
- Wetted materials: Silicon, glass, copper, silicone, epoxy, mold compound.
- Tolerance on all dimensions ± 0.13 mm unless otherwise specified.
- [B] is tube connected to bottom side of sensor die.
- [T] is tube connected to top side of sensor die. Topside pressure is positive pressure. An increase in topside pressure will result in an increase in sensor output

Lot Number Identification

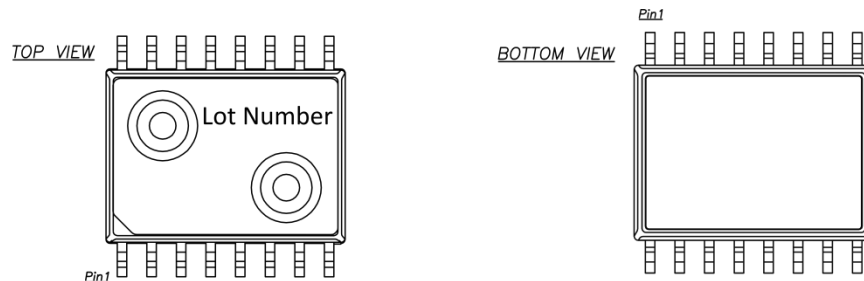

SOIC-16 Horizontal (B) Package Dimensions

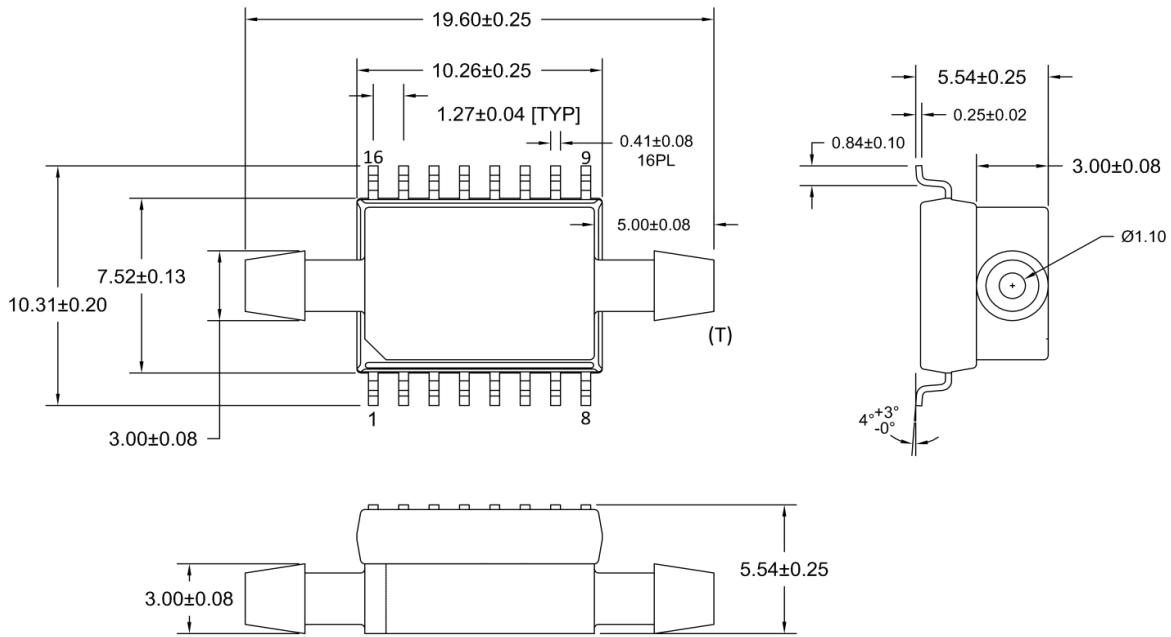

Dimensions are in mm

Qualification Standards

REACH Compliant

RoHS Compliant

PFOS/PFOA Compliant

For qualification specifications, please contact Sales at sales@si-micro.com



SM7X21 + Family Applications Circuit

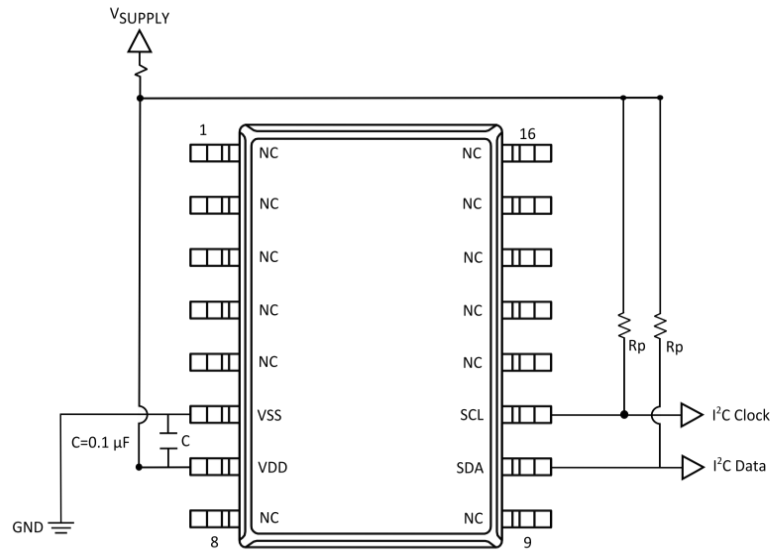

"C" needs to be in close proximity of the device

Rp = Pull-up Resistors
For Example: 4.7 kΩ Resistors

Package Labeling	
Pin No.	Pin Function
1	NC (No Connect)
2	NC
3	NC
4	NC
5	NC
6	VSS
7	VDD
8	NC
9	NC
10	SDA
11	SCL
12	NC
13	NC
14	NC
15	NC
16	NC

NOTES:

- Do not connect to NC pins

Ordering Information: Specific part number information is provided on a separate cut sheet for each product. The general part number ordering information is provided below:

Part Number Legend

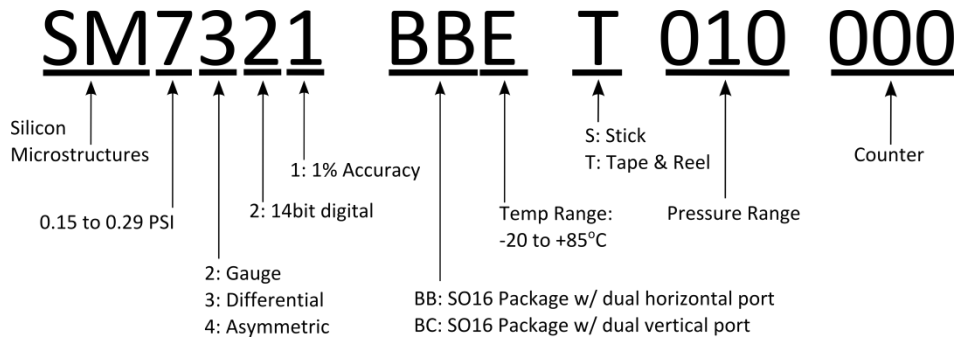

*Custom calibration pressures and voltages are available to meet specific customer demands. Dual vertical or dual horizontal ports available.

Silicon Microstructures Warranty and Disclaimer:

Silicon Microstructures, Inc. reserves the right to make changes without further notice to any products herein and to amend the contents of this data sheet at any time and at its sole discretion.

Information in this document is provided solely to enable software and system implementers to use Silicon Microstructures, Inc. products and/or services. No express or implied copyright licenses are granted hereunder to design or fabricate any silicon-based microstructures based on the information in this document.

Silicon Microstructures, Inc. makes no warranty, representation, or guarantee regarding the suitability of its products for any particular purpose, nor does Silicon Microstructures, Inc. assume any liability arising out of the application or use of any product or silicon-based microstructure, and specifically disclaims any and all liability, including without limitation consequential or incidental damages. "Typical" parameters which may be provided in Silicon Microstructure's data sheets and/or specifications can and do vary in different applications and actual performance may vary over time. All operating parameters, including "Typicals", must be validated for each customer application by customer's technical experts. Silicon Microstructures, Inc. does not convey any license under its patent rights nor the rights of others. Silicon Microstructures, Inc. makes no representation that the circuits are free of patent infringement. Silicon Microstructures, Inc. products are not designed, intended, or authorized for use as components in systems intended for surgical implant into the body, or other applications intended to support or sustain life, or for any other application in which the failure of the Silicon Microstructures, Inc. product could create a situation where personal injury or death may occur. Should Buyer purchase or use Silicon Microstructures, Inc. products for any such unintended or unauthorized application, Buyer shall indemnify and hold Silicon Microstructures, Inc. and its officers, employees, subsidiaries, affiliates, and distributors harmless against all claims, costs, damages, and expenses, and reasonable attorney fees arising out of, directly or indirectly, any claim of personal injury or death associated with such unintended or unauthorized use, even if such claim alleges that Silicon Microstructures, Inc. was negligent regarding the design or manufacture of the part.

Silicon Microstructures, Inc. warrants goods of its manufacture as being free of defective materials and faulty workmanship. Silicon Microstructures, Inc. standard product warranty applies unless agreed to otherwise by Silicon Microstructures, Inc. in writing; please refer to your order acknowledgement or contact Silicon Microstructures, Inc. directly for specific warranty details. If warranted goods are returned to Silicon Microstructures, Inc. during the period of coverage, Silicon Microstructures, Inc. will repair or replace, at its option, without charge those items it finds defective. The foregoing is buyer's sole remedy and is in lieu of all warranties, expressed or implied, including those of merchantability and fitness for a particular purpose. In no event shall Silicon Microstructures, Inc. be liable for consequential, special, or indirect damages.

While Silicon Microstructures, Inc. provides application assistance personally, through its literature and the Silicon Microstructures, Inc. website, it is up to the customer to determine the suitability of the product for its specific application. The information supplied by Silicon Microstructures, Inc. is believed to be accurate and reliable as of this printing. However, Silicon Microstructures, Inc. assumes no responsibility for its use. Silicon Microstructures, Inc. assumes no responsibility for any inaccuracies and/or errors in this publication and reserves the right to make changes without further notice to any products or specifications herein

Silicon Microstructures, Inc.™ and the Silicon Microstructures, Inc. logo are trademarks of Silicon Microstructures, Inc. All other service or product names are the property of their respective owners.

© Silicon Microstructures, Inc. 2001-2017. All rights reserved.

X-ON Electronics

Largest Supplier of Electrical and Electronic Components

Click to view similar products for [Board Mount Pressure Sensors](#) category:

Click to view products by [Silicon Microstructures](#) manufacturer:

Other Similar products are found below :

[80527-25.0H2-05](#) [80541-B00000150-01](#) [80541-B00000200-05](#) [80554-00700100-05](#) [80568-00300050-01](#) [81618-B00000040-01](#) [81739-B00000900-01](#) [81807-B00000020-01](#) [81808-B00000150-14](#) [82903-B00000020-01](#) [93.631.4253.0](#) [93.731.4353.0](#) [93.932.4553.0](#) [136PC150G2](#) [136PC15A1](#) [142PC95AW71](#) [142PC05DW70](#) [MPXV2202DPT1](#) [15PSI-G-4V](#) [1805-01A-L0N-B](#) [2000317-1](#) [26PCBKT](#) [26PCCFA6D26](#) [26PCCFS2G](#) [26PCCVA6D](#) [93.632.7353.0](#) [93.731.3653.0](#) [93.931.4853.0](#) [93.932.4853.0](#) [SCDA120-XSC05DC](#) [SP370-23-156-0](#) [185PC30DH](#) [192992-0059](#) [20INCH-G-MV-MINI](#) [26PCAFJ3G](#) [26PCAFS2G54](#) [26PCCEP5G24](#) [26PCJEU5G19](#) [30INCH-D1-MV-MINI](#) [ASCX15AN-90](#) [TSCSAAN001PDUCV](#) [DCAL401DN](#) [DCAL401GN](#) [XZ202798SSC](#) [XZ203676HSC](#) [SP370-25-116-0](#) [81717-00000050-05](#) [81794-B00001200-01](#) [HSCDLNN100PGAA5](#) [81618-B00000040-05](#)