

SYMBOL DEFINITION		MISSING NUMBERS	
A DIMENSION WITHOUT AN INSPECTION REPORT SYMBOL  DOES NOT REQUIRE INSPECTION. IT MAY BE CONTROLLED ON AN INDIVIDUAL COMPONENT DRAWING.	TOTAL NO. OF SYMBOLS ON DRAWING	9	
	LAST NO. USED	14	

DWG STATUS					ZONE	REVISION HISTORY	AUTH	DR	APVD1	APVD2
DATE	STG	REV	N/P	CHG						
080C04	R	01	-	-		RELEASED - WAS PE070979	000005	END	END	KL
20JL00	R	02	-	-		INCREASED ANGLE AND RADII - 2 PLCS	202209	END	END	KL
060C00	R	02	AA	-		ADDED "SHARP CORNERS" NOTE TO PD	203027	END	END	KL
13N000	R	02	AB	-		ADD -0.50 TOL. TO 7.3 DIM.	204448	SHH	END	KL
01DE00	R	03	-	-		REVISED FRONT NOSE OF LEGS	204983	END	END	KL
27MRO1	R	03	AA	-		REVISED MAKE PRINT MATCH PART	208196	END	END	KL
02MY01	R	03	AB	-		REVISED TOLERANCES AND DIM.	209302	JEB	JEB	SMM
07MY01	R	03	AC	-		7.3 +0.15/-1.06 DUE TO BOW WAS 7.3 +0.15/-0.85; ADDED CONSTANT TO DIM 2X 1.74 ±0.05	209476	MAC	MAC	SMM
12JL01	R	03	AD	-		REVISED TOLERANCE ON DIM #5-6	211797	RH	RH	SMM
080C04	R	03	AE	-		MATERIAL SPEC WAS R0100115 PBT0F 30-GRN; ADDED PROCESS SENSITIVE DIM #7 AND ADDED NOTES 3 & 4	259925	HAM	HAM	EST

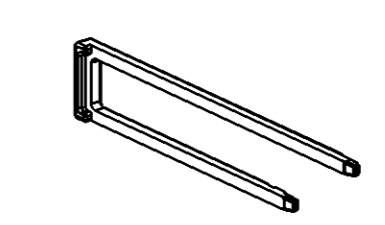

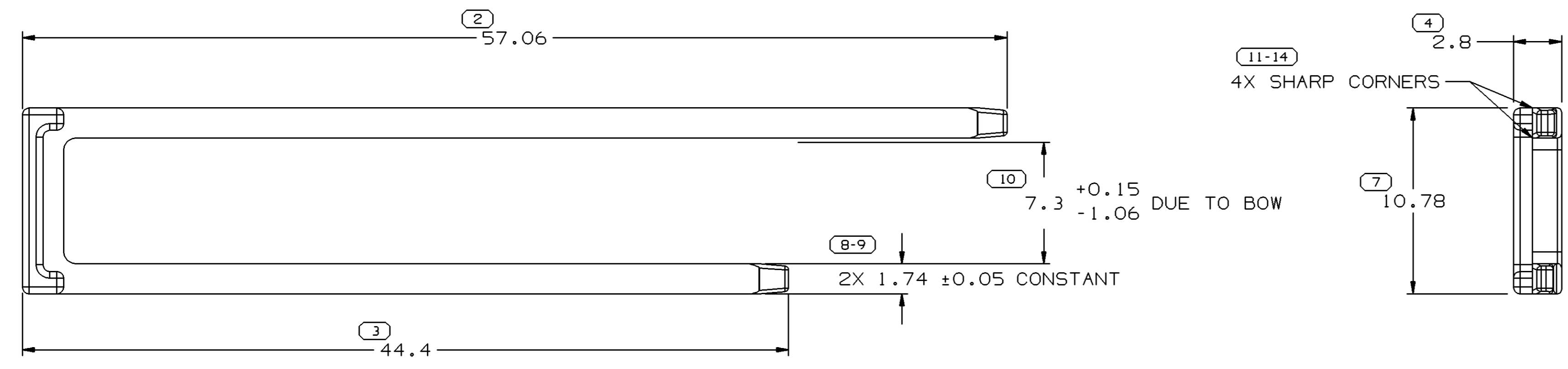
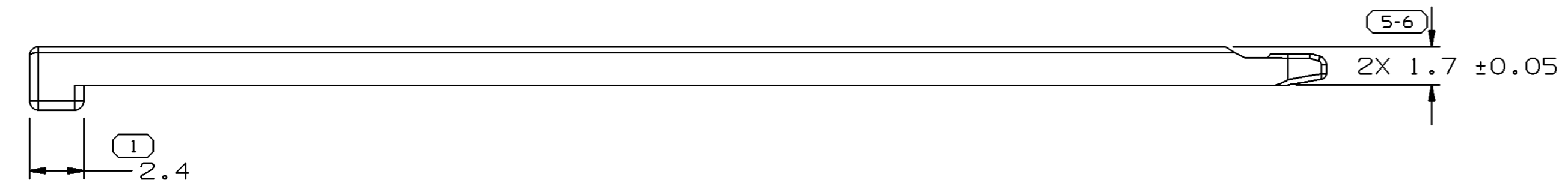

SCALE 1:1

NOTES

- UNLESS OTHERWISE SPECIFIED AND/OR INDICATED: DIMENSIONS ARE TO FACE OF VIEW SHOWN AND AUTOMATICALLY ROUNDED BY COMPUTER FOR INSPECTION (SEE MATH MODEL FOR PRECISE DIMENSIONS). FOR ALL OTHER DIMENSIONS NOT SHOWN BUT REQUIRED FOR TOOL BUILD, SEE MATH MODEL FOR PRECISE TOOL PATH DATA.
- PARTS SHOWN ON THIS DRAWING USED IN ASSEMBLIES SHOWN ON TAXI 15357130.
- MATERIAL RECYCLING CODE PER ISO 11469. (2.3)X(0.1) CHARACTERS AS SHOWN TO BE LOCATED ON ANY EXTERIOR SURFACE. OPTIONAL CONSTRUCTION TO BE NO LOGO.
- (2.3)X(0.1) DELPHI CORPORATE BRAND TO BE LOCATED ON ANY EXTERIOR SURFACE, PREFERABLY VISIBLE AT FINAL ASSEMBLY. OPTIONAL CONSTRUCTION TO BE "PED". OPTIONAL CONSTRUCTION TO BE NO LOGO.

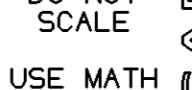
7 PROCESS SENSITIVE DIMENSION	
DIMENSIONS ENCLOSED IN () INDICATE REFERENCE DIMENSIONS AND NO TOLERANCE LIMITS ARE ESTABLISHED	
DIMENSIONAL RANGE (MM)	CHART E
FROM 0 TO 20	> 20
TO 20	> 30
	> 70
	> 100
TOLERANCE UNLESS OTHERWISE SPECIFIED	
±0.15	±0.2
±0.3	±0.4
±0.5	
ANGULAR TOLERANCE ±2°	

DWG TYPE PART DRAWING	
STYLE	
VOLUME (CM³) 0.334	DISTR CODE D
UNLESS OTHERWISE SPECIFIED THIS DOCUMENT IS IN ACCORDANCE WITH ASME Y14.5M-1994 AS AMENDED BY THE GM GLOBAL DIMENSIONING AND TOLERANCING ADDENDUM-2001. SEPARATE PATTERNS OF FEATURES MAY BE GAGED SEPARATELY REGARDLESS OF DATUM REFERENCES.	
ALL DIMENSIONS ARE IN MILLIMETERS	
REFERENCE	
THIRD ANGLE PROJECTION	DO NOT SCALE
	
USE MATH DATA	

DELPHI	
DELPHI PACKARD ELECTRIC SYSTEMS WARREN, OH	
DR	DATE
APVD1 D. HEBERLEIN	24FE98
APVD2 E. NEAL DUNHAM	20MRO0
APVD3 E. NEAL DUNHAM	20MRO0
APVD4 K. LISOWSKI	20MRO0
APVD5	
SUBSTANCES OF CONCERN AND RECYCLED CONTENT PER DELPHI 10949001	
MATERIAL M4698007 PBT 0F30 GRN	
DRAWING NAME LOCK TPA COMB GRN	
DRAWING NUMBER 15357143	
SIZE A1	SCALE 5:1
FRAME NO 1 OF 1	SHEET NO 1 OF 1
STG R	REV 03
N/P AE	

X-ON Electronics

Largest Supplier of Electrical and Electronic Components

Click to view similar products for [Automotive Connectors](#) category:

Click to view products by [Delphi](#) manufacturer:

Other Similar products are found below :

[003-018-000](#) [600858](#) [60403001](#) [60993906-B](#) [60993913-B](#) [629515004020001](#) [M902-2131](#) [M902-2161](#) [M902-2344](#) [72.330.1035.1](#)
[73.353.4028.0](#) [F118010](#) [F119300-B](#) [F132210](#) [F132210-B](#) [F166900](#) [F180100](#) [F258300](#) [F258300-B](#) [F294300-B](#) [F339100](#) [F339700](#) [F358300-](#)
[B](#) [F374110](#) [F407400](#) [F412210](#) [F427600](#) [F444110](#) [F487000](#) [F495100-B](#) [F500900-B](#) [F509500B-B](#) [770444-1](#) [776880-1](#) [827153-1](#) [881735-1](#)
[8N1515-32-24P](#) [9-1326727-8](#) [9-1326729-8](#) [925467-1](#) [925474-1](#) [928905-1](#) [936398-2](#) [964562-1](#) [964562-4](#) [964731-2](#) [965051-1](#) [968782-1](#)
[GT17SA-8DS-HU](#) [GT17VS-10DP-5.2CF](#)