

## EMC filters

2-line filters

SIFI-G for enhanced insertion loss

**Series/Type:**        **B84112G**

**Date:**                January 2015

© EPCOS AG 2015. Reproduction, publication and dissemination of this publication, enclosures hereto and the information contained therein without EPCOS' prior express consent is prohibited.

EPCOS AG is a TDK Group Company.

**SIFI-G for enhanced insertion loss**
**Power line filters for 1-phase systems**
**Rated voltage  $V_R$ : 250 V AC/DC**
**Rated current  $I_R$ : 2 A to 36 A**
**Construction**

- 2-line filters
- Metal case
- Polyurethane potting (UL 94 V-0)

**Versions**

- Standard version (B84112G0000B\*/G\*)
- For applications with low leakage current (B84112G0000M\*)

**Features**

- Easy to install
- Compact design
- Cost optimized construction
- ENEC, UL and cUL approval

**Typical applications**

- Switch-mode power supplies
- Industrial electronics
- Telecom systems
- Data systems
- DC applications
- Medical equipment (version B84112G0000M\*)

**Terminals**

2 A ... 16 A: Tab connectors

20 A ... 36 A: Threaded studs

**Marking**

Marking on component:

Manufacturer's logo, ordering code, rated voltage, rated current, rated temperature, climatic category, date code, approvals

Minimum data on packaging:

Manufacturer's logo, ordering code, quantity, date code





**SIFI-G for enhanced insertion loss**
**Circuit diagram (standard version)**

**Circuit diagram (medical version)**

**Technical data and measuring conditions**

|                                 |  |
|---------------------------------|--|
| Rated voltage $V_R$             | 250 V AC (50/60 Hz) / 250 V DC   |
| Rated current $I_R$             | Referred to 40 °C rated temperature  |
| Test voltage $V_{test}$         | 1770 V DC, 2 s (line/line)   |
|                                 | Standard version: 2700 V DC, 2 s (lines/case)<br>Medical version: 2500 V AC (lines/case) |
| Leakage current $I_{LK}$        | At 250 V AC and 50 Hz  |
| Climatic category (IEC 60068-1) | 25/100/21 (-25 °C/+100 °C/21 days damp heat test)  |
| Approvals                       | IEC 60939, UL 1283, CSA C22.2 No.8   |

**Characteristics and ordering codes**

| $I_R$                       | $C_R$<br>X2     | $C_R$<br>Y2     | $L_R$          | $I_{LK}$ | Approx.<br>weight<br>g | Ordering code   | Approvals   |   |  |
|-----------------------------|-----------------|-----------------|----------------|----------|------------------------|-----------------|---|---|--|
| A                           | $\mu\text{F}$   | pF              | mH             | mA       |                        |                 |  |  |  |
| $V_R = 250 \text{ V AC/DC}$ |                 |                 |                |          |                        |                 |   |   |  |
| 2                           | $2 \times 0.15$ | $2 \times 4700$ | $2 \times 12$  | 0.369    | 90                     | B84112G0000B020 | ×   | ×   | ×  |
| 2                           | $2 \times 0.15$ | —               | $2 \times 12$  | 0        | 90                     | B84112G0000M020 | ×   | ×   | ×  |
| 3                           | $2 \times 0.22$ | $2 \times 4700$ | $2 \times 10$  | 0.369    | 200                    | B84112G0000B030 | ×   | ×   | ×  |
| 3                           | $2 \times 0.22$ | —               | $2 \times 10$  | 0        | 200                    | B84112G0000M030 | ×   | ×   | ×  |
| 6                           | $2 \times 0.47$ | $2 \times 4700$ | $2 \times 3.3$ | 0.369    | 200                    | B84112G0000B060 | ×   | ×   | ×  |
| 6                           | $2 \times 0.47$ | —               | $2 \times 3.3$ | 0        | 200                    | B84112G0000M060 | ×   | ×   | ×  |
| 8                           | $2 \times 0.47$ | $2 \times 4700$ | $2 \times 2.5$ | 0.369    | 200                    | B84112G0000B080 | ×   | ×   | ×  |
| 8                           | $2 \times 0.47$ | —               | $2 \times 2.5$ | 0        | 200                    | B84112G0000M080 | ×   | ×   | ×  |
| 10                          | $2 \times 0.68$ | $2 \times 4700$ | $2 \times 1.8$ | 0.369    | 200                    | B84112G0000B110 | ×   | ×   | ×  |
| 10                          | $2 \times 0.68$ | —               | $2 \times 1.8$ | 0        | 200                    | B84112G0000M110 | ×   | ×   | ×  |
| 12                          | $2 \times 0.68$ | $2 \times 4700$ | $2 \times 1.6$ | 0.369    | 200                    | B84112G0000B112 | ×   | ×   | ×  |
| 12                          | $2 \times 0.68$ | —               | $2 \times 1.6$ | 0        | 200                    | B84112G0000M112 | ×   | ×   | ×  |
| 16                          | $2 \times 0.47$ | $2 \times 4700$ | $2 \times 1.8$ | 0.369    | 210                    | B84112G0000B116 | ×   | ×   | ×  |
| 16                          | $2 \times 0.47$ | —               | $2 \times 1.8$ | 0        | 210                    | B84112G0000M116 | ×   | ×   | ×  |
| 20                          | $2 \times 1.0$  | $2 \times 4700$ | $2 \times 1.8$ | 0.369    | 440                    | B84112G0000G120 | ×   | ×   | ×  |
| 20                          | $2 \times 1.0$  | —               | $2 \times 1.8$ | 0        | 440                    | B84112G0000M120 | ×   | ×   | ×  |
| 25                          | $2 \times 1.0$  | $2 \times 4700$ | $2 \times 1.6$ | 0.369    | 440                    | B84112G0000G125 | ×   | ×   | ×  |
| 25                          | $2 \times 1.0$  | —               | $2 \times 1.6$ | 0        | 440                    | B84112G0000M125 | ×   | ×   | ×  |
| 36                          | $2 \times 1.5$  | $2 \times 4700$ | $2 \times 0.8$ | 0.369    | 470                    | B84112G0000G136 | ×   | ×   | ×  |
| 36                          | $2 \times 1.5$  | —               | $2 \times 0.8$ | 0        | 470                    | B84112G0000M136 | ×   | ×   | ×  |

× = Approval granted

Dimensional drawings

B84112G0000B020 and B84112G0000M020 (2 A)



General tolerances according to ISO 2768–cL  
Dimensions in mm

B84112G0000\*030 ... B84112G0000\*116 (3 A ... 16 A)



General tolerances according to ISO 2768–cL  
Dimensions in mm

B84112G0000\*120, B84112G0000\*136 (20 A ... 36 A)

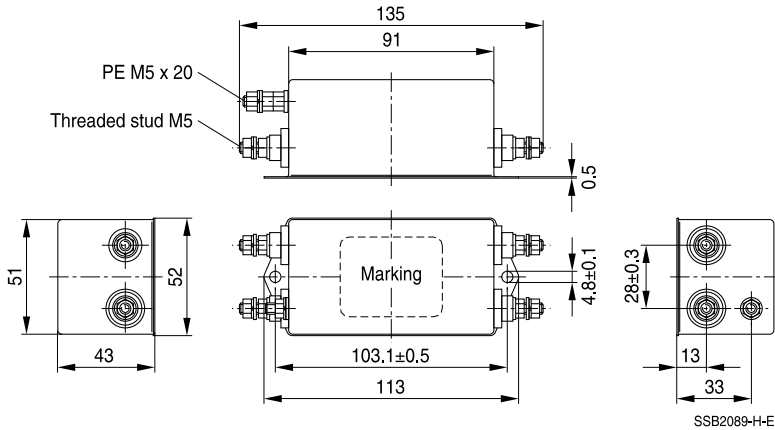

General tolerances according to ISO 2768–cL  
 Dimensions in mm

SIFI-G for enhanced insertion loss

Insertion loss for standard version (typical values at  $Z = 50 \Omega$ )

- unsymmetrical, adjacent branches terminated
- - - - - common mode, all branches in parallel (asymmetrical)
- - - - - differential mode (symmetrical)

Filters for 2 A

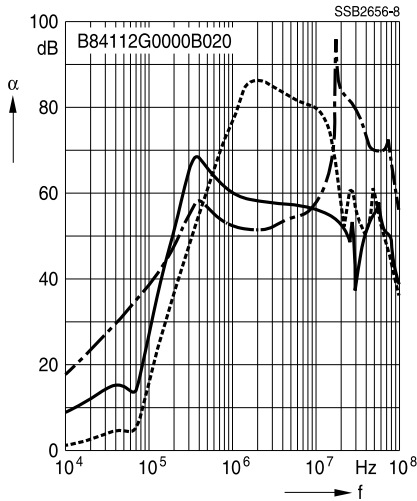

Filters for 3 A

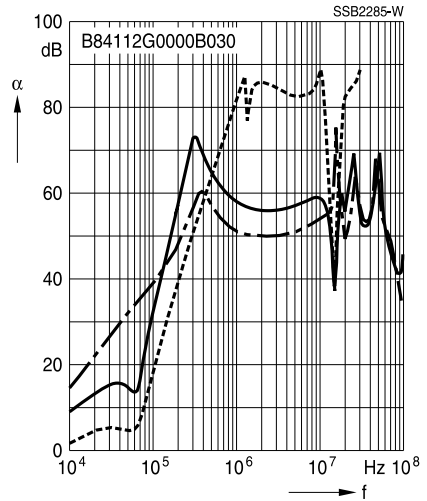

Filters for 6 A

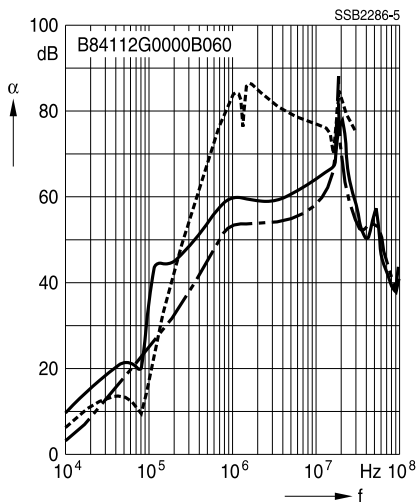

Filters for 8 A

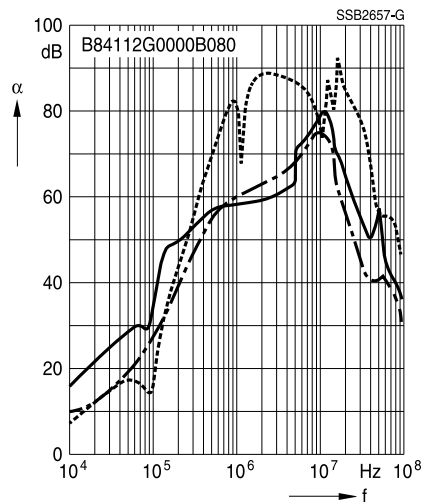

SIFI-G for enhanced insertion loss

Insertion loss for standard version (typical values at  $Z = 50 \Omega$ )

- unsymmetrical, adjacent branches terminated
- - - - - common mode, all branches in parallel (asymmetrical)
- - - - - differential mode (symmetrical)

Filters for 10 A



Filters for 12 A



Filters for 16 A



Filters for 20 A





SIFI-G for enhanced insertion loss

Insertion loss for standard version (typical values at  $Z = 50 \Omega$ )

- unsymmetrical, adjacent branches terminated
- - - - - common mode, all branches in parallel (asymmetrical)
- - - - - differential mode (symmetrical)

Filters for 25 A

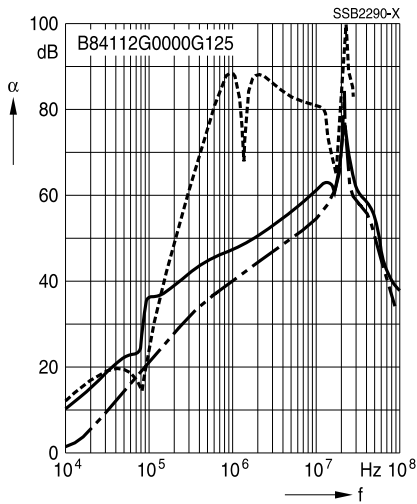

Filters for 36 A

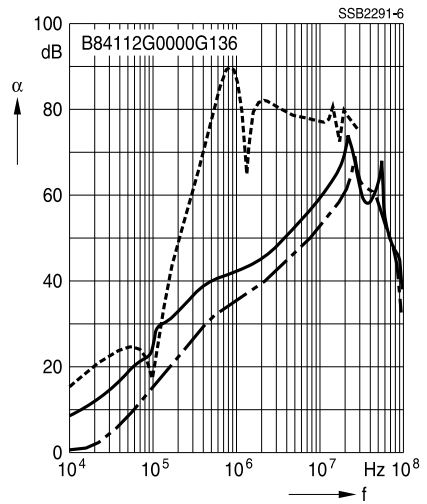

**SIFI-G for enhanced insertion loss**

**Insertion loss for medical version (typical values at Z = 50 Ω)**

- unsymmetrical, adjacent branches terminated
- - - - - common mode, all branches in parallel (asymmetrical)
- - - - - differential mode (symmetrical)

**Filters for 2 A**



**Filters for 3 A**

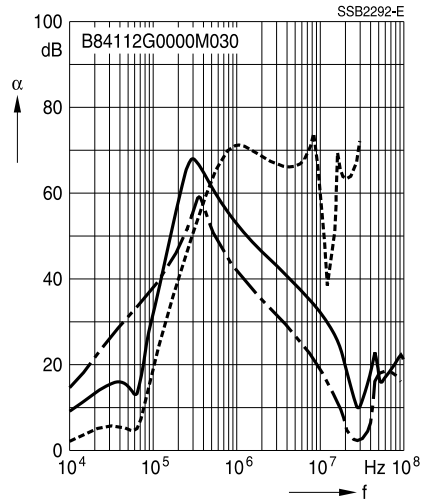

**Filters for 6 A**



**Filters for 8 A**

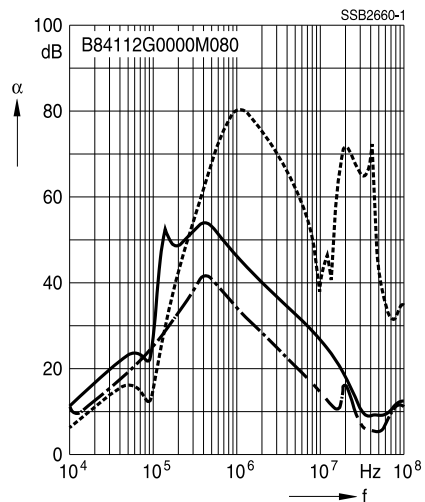

SIFI-G for enhanced insertion loss

Insertion loss for medical version (typical values at  $Z = 50 \Omega$ )

- unsymmetrical, adjacent branches terminated
- - - - - common mode, all branches in parallel (asymmetrical)
- - - - - differential mode (symmetrical)

Filters for 10 A



Filters for 12 A



Filters for 16 A



Filters for 20 A



SIFI-G for enhanced insertion loss

**Insertion loss for medical version** (typical values at  $Z = 50 \Omega$ )

- unsymmetrical, adjacent branches terminated
- - - - - common mode, all branches in parallel (asymmetrical)
- - - - - differential mode (symmetrical)

Filters for 25 A

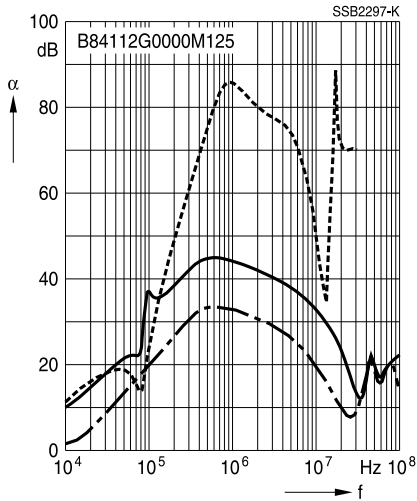

Filters for 36 A



## Cautions and warnings

Please read all safety and warning notes carefully before installing the EMC filter and putting it into operation (see ). The same applies to the warning signs on the filter. Please ensure that the signs are not removed nor their legibility impaired by external influences.

Death, serious bodily injury and substantial material damage to equipment may occur if the appropriate safety measures are not carried out or the warnings in the text are not observed.

## Using according to the terms

The EMC filters may be used only for their intended application within the specified values in low-voltage networks in compliance with the instructions given in the data sheets and the data book. The conditions at the place of application must comply with all specifications for the filter used.

### Warning

- It shall be ensured that only qualified persons (electricity specialists) are engaged on work such as planning, assembly, installation, operation, repair and maintenance. They must be provided with the corresponding documentation.
- Danger of electric shock. EMC filters contain components that store an electric charge. Dangerous voltages can continue to exist at the filter terminals for longer than five minutes even after the power has been switched off.
- The protective earth connections shall be the first to be made when the EMC filter is installed and the last to be disconnected. Depending on the magnitude of the leakage currents, the particular specifications for making the protective-earth connection must be observed.
- Impermissible overloading of the EMC filter or filter, such as with circuits able to cause resonances, impermissible voltages at higher frequencies etc. can lead to bodily injury and death as well as cause substantial material damages (e.g. destruction of the filter housing).
- EMC filters and filters must be protected in the application against impermissible exceeding of the rated currents by overcurrent protective circuitry.
- In case of leakage currents  $>3.5$  mA you shall mount the PE conductor stationary with the required cross section before beginning of operation and save it against disconnecting. For leakage currents  $I_L^{(1)} \leq 10$  mA the PE conductor must have a KU value<sup>2)</sup> of 4.5 A<sup>3)</sup>; for leakage currents  $I_L > 10$  mA the PE conductor must have a KU value of 6<sup>4)</sup>.
- Output chokes and output filters must be protected in the application against impermissible exceeding of the component temperature.
- The converter output frequency must be within the specified range to avoid resonances and uncontrolled warming of the output chokes and output filters.

1)  $I_L$  = leakage current let-go

2) The KU value (symbol KU) is a classification parameter of safety-referred failure types designed to ensure protection against hazardous body currents and excessive heating.

3) A value of KU = 4.5 with respect to interruptions is attained with: a) permanently connected protective earth circuit  $\geq 1.5$  mm<sup>2</sup> and b) a protective conductor connection  $\geq 2.5$  mm<sup>2</sup> via connectors for industrial equipment (IEC 60309–2)

4) KU = 6 with respect to interruptions is achieved for fixed–connection lines  $\geq 10$  mm<sup>2</sup> where the type of connection and line layout correspond to the requirements for PEN conductors as specified in relevant standards.

The table below summarizes the safety instructions that must be observed without fail. A detailed description can be found in the relevant chapters of the databook.

| Topic   | Instructions  | Reference chapter (data book), paragraph               |
|---|---|--|
| Selecting a filter  | When selecting a filter, it is mandatory to observe the rated data of the equipment (such as its rated input current, rated voltage, harmonic content etc.) as well as the derating instructions in Chapters 9 and 10.  | Selection guide for converter filters                  |
| Rated voltage   | When power distribution systems deviating from the symmetric TN-S system it is to check the suitability of the EMC filters and the allowed voltages including the fault cases.  | Power distribution systems, 7                          |
| Protection from residual voltages<br>Discharge resistors      | Active parts must be discharged within 5 s to a voltage of less than 60 V (or 50 $\mu$ C). If this limit cannot be observed due to the operating mode, the hazardous point must be permanently marked in a clearly visible way.<br><br>Filters which are not permanently connected (e.g. when the test voltage is applied to the filter at the incoming goods inspection) must be discharged after the voltage has been switched off. | Safety regulations, 6.1<br><br>Safety regulations, 6.2 |
| Installing and removing of EMC filters<br>Installation        | When installing and removing our EMC filters, a voltage-free state must be set up and secured with observance of the five safety rules described in EN 50110-1.   | Safety regulations, 6.4                                |
| Use in IT systems   | The special features of the IT system ("first fault case" and other fault cases) shall be observed.   | Power distribution system (network types), 7.6         |
| Safety notes on leakage currents                              | The filter leakage currents specified in the data book are intended for user information only. The maximum leakage current of the entire electrical equipment or appliance has to be limited for safety reasons. Please obtain the applicable limits for your application from the relevant regulations, provisions and standards.  | Leakage current, 8.4<br>Leakage current, 8.6           |
| Voltage derating<br>Hazards caused by overloading the filters | If the permissible limits for the higher-frequency voltages at the filter are exceeded, the filter may be damaged or destroyed.   | Voltage derating, 9.8                                  |
| Current derating at elevated ambient temperatures             | Non-observance of the current derating may lead to overheating and consequently represents a fire hazard.   | Current derating, 10.1                                 |

**SIFI-G for enhanced insertion loss**

| Topic  | Instructions   | Reference chapter (data book), paragraph |
|--|--|--|
| Protective earth connection at operating currents >250 A | For operating currents greater than 250 A, we recommend the PE connection to be set up between the feed (filter: line) and output (filter: load) not via the PE terminal bolt in the filter housing.   | Mounting instructions, point 2           |
| Mounting position  | Note the mounting position of the filters! It must always be ensured that natural convection is not impaired.  | Mounting instructions, point 13          |
| Long motor cables  | Long motor cables cause parasitic currents in the installation. The cable lengths indicated for the output chokes and output filters serve for orientation. The user must check the technical parameters and especially the choke temperatures for the respective application. | Mounting instructions, point 15          |

**Display of ordering codes for EPCOS products**

The ordering code for one and the same product can be represented differently in data sheets, data books, other publications and the website of EPCOS, or in order-related documents such as shipping notes, order confirmations and product labels. The varying representations of the ordering codes are due to different processes employed and do not affect the specifications of the respective products. Detailed information can be found on the Internet under [www.epcos.com/orderingcodes](http://www.epcos.com/orderingcodes).

**Symbols and terms**

| Symbol      | English                                       | German                           |
|-------------|---|----------------------------------|
| $\alpha$    | Insertion loss                                | Einfügungsdämpfung               |
| $C_R$       | Rated capacitance                             | Bemessungskapazität              |
| $C_X$       | Capacitance X capacitor                       | Kapazität X-Kondensator          |
| $C_Y$       | Capacitance Y capacitor                       | Kapazität Y-Kondensator          |
| $\Delta V$  | Voltage drop (input to output)                | Spannungsabfall im Filter        |
| $dv/dt$     | Rate of voltage rise                          | Spannungsanstiegsgeschwindigkeit |
| $f$         | Frequency                                     | Frequenz                         |
| $f_M$       | Converter output frequency                    | Motorfrequenz                    |
| $f_P$       | Pulse frequency                               | Pulsfrequenz                     |
| $f_R$       | Rated frequency                               | Bemessungsfrequenz               |
| $f_{res}$   | Resonant frequency                            | Resonanzfrequenz                 |
| $I_C$       | Current through capacitor                     | Strom durch Kondensator          |
| $I_{LK}$    | Filter leakage current                        | Filter-Ableitstrom               |
| $I_{max}$   | Maximum current                               | Maximalstrom                     |
| $I_N$       | Nominal current                               | Nennstrom                        |
| $I_{op}$    | Operating current (design current)            | Betriebsstrom                    |
| $I_{pk}$    | Rated peak withstand current                  | Bemessungs-Stoßstromfestigkeit   |
| $I_q$       | Capacitive reactive current                   | Kapazitiver Blindstrom           |
| $I_R$       | Rated current                                 | Bemessungsstrom                  |
| $I_S$       | Interference current                          | Störstrom                        |
| $L$         | Inductance                                    | Induktivität                     |
| $L_R$       | Rated inductance                              | Bemessungsinduktivität           |
| $L_{stray}$ | Stray inductance                              | Streuinduktivität                |
| $P_L$       | Power loss                                    | Verlustleistung                  |
| $R$         | Resistance                                    | Widerstand                       |
| $R_{is}$    | Insulation resistance                         | Isolationswiderstand             |
| $R_{typ}$   | DC resistance, typical value                  | Gleichstromwiderstand, Richtwert |
| $T_A$       | Ambient temperature                           | Umgebungstemperatur              |
| $T_{max}$   | Upper category temperature                    | Obere Kategorietemperatur        |
| $T_{min}$   | Lower category temperature                    | Untere Kategorietemperatur       |
| $T_R$       | Rated temperature                             | Bemessungstemperatur             |
| $u_k$       | Referred voltage drop in %                    | Bezogener Spannungsabfall in %   |
| $V_{eff}$   | RMS voltage                                   | Effektivspannung                 |
| $V_K$       | Voltage drop                                  | Spannungsabfall                  |
| $V_{LE}$    | Voltage line to earth; voltage line to ground | Spannung Phase zu Erdpotential   |
| $V_N$       | Nominal voltage                               | Nennspannung                     |
| $V_R$       | Rated voltage                                 | Bemessungsspannung               |
| $V_{peak}$  | Peak voltage                                  | Spitzenspannung                  |
| $V_{test}$  | Test voltage                                  | Prüfspannung                     |
| $V_X$       | Voltage over X capacitor                      | Spannung über X-Kondensator      |
| $V_Y$       | Voltage over Y capacitor                      | Spannung über Y-Kondensator      |
| $X_L$       | Inductive reactance                           | Induktiver Blindwiderstand       |
| $Z$         | Impedance                                     | Scheinwiderstand                 |
| $ Z $       | Impedance, absolute value                     | Scheinwiderstand (Betragswert)   |



## Important notes

The following applies to all products named in this publication:

1. Some parts of this publication contain **statements about the suitability of our products for certain areas of application**. These statements are based on our knowledge of typical requirements that are often placed on our products in the areas of application concerned. We nevertheless expressly point out **that such statements cannot be regarded as binding statements about the suitability of our products for a particular customer application**. As a rule, EPCOS is either unfamiliar with individual customer applications or less familiar with them than the customers themselves. For these reasons, it is always ultimately incumbent on the customer to check and decide whether an EPCOS product with the properties described in the product specification is suitable for use in a particular customer application.
2. We also point out that **in individual cases, a malfunction of electronic components or failure before the end of their usual service life cannot be completely ruled out in the current state of the art, even if they are operated as specified**. In customer applications requiring a very high level of operational safety and especially in customer applications in which the malfunction or failure of an electronic component could endanger human life or health (e.g. in accident prevention or lifesaving systems), it must therefore be ensured by means of suitable design of the customer application or other action taken by the customer (e.g. installation of protective circuitry or redundancy) that no injury or damage is sustained by third parties in the event of malfunction or failure of an electronic component.
3. **The warnings, cautions and product-specific notes must be observed.**
4. In order to satisfy certain technical requirements, **some of the products described in this publication may contain substances subject to restrictions in certain jurisdictions (e.g. because they are classed as hazardous)**. Useful information on this will be found in our Material Data Sheets on the Internet ([www.epcos.com/material](http://www.epcos.com/material)). Should you have any more detailed questions, please contact our sales offices.
5. We constantly strive to improve our products. Consequently, **the products described in this publication may change from time to time**. The same is true of the corresponding product specifications. Please check therefore to what extent product descriptions and specifications contained in this publication are still applicable before or when you place an order. We also **reserve the right to discontinue production and delivery of products**. Consequently, we cannot guarantee that all products named in this publication will always be available. The aforementioned does not apply in the case of individual agreements deviating from the foregoing for customer-specific products.
6. Unless otherwise agreed in individual contracts, **all orders are subject to the current version of the "General Terms of Delivery for Products and Services in the Electrical Industry" published by the German Electrical and Electronics Industry Association (ZVEI)**.

## Important notes

7. The trade names EPCOS, Alu-X, CeraDiode, CeraLink, CeraPad, CeraPlas, CSMP, CSSP, CTVS, DeltaCap, DigiSiMic, DSSP, FilterCap, FormFit, LeaXield, MiniBlue, MiniCell, MKD, MKK, MotorCap, PCC, PhaseCap, PhaseCube, PhaseMod, PhiCap, PQSine, SIFERRIT, SIFI, SIKOREL, SilverCap, SIMDAD, SiMic, SIMID, SineFormer, SIOV, SIP5D, SIP5K, TFAP, ThermoFuse, WindCap are **trademarks registered or pending** in Europe and in other countries. Further information will be found on the Internet at [www.epcos.com/trademarks](http://www.epcos.com/trademarks).

## X-ON Electronics

Largest Supplier of Electrical and Electronic Components

*Click to view similar products for [Power Line Filters](#) category:*

*Click to view products by [EPCOS](#) manufacturer:*

Other Similar products are found below :

[5B1](#) [6609019-3](#) [6609026-5](#) [6609030-6](#) [6609063-2](#) [6609973-2](#) [7-1609090-5](#) [F1500CA06](#) [F7382Z](#) [F7863Z](#) [FAHAV3100ZC000](#) [806276](#)  
[FN2020B-1-06](#) [FN2080B-10-06](#) [FN2090A-1-06](#) [FN2410H-32-33](#) [FN2410H-80-34](#) [FN2412H-16-44](#) [FN406B-0.5-02](#) [FN420-1-13](#) [FP144](#) [8-](#)  
[6609089-0](#) [12-MMB-030-11-D](#) [B84144A90R120](#) [20B1](#) [RSEL-2001A](#) [2B1](#) [1-6609070-1](#) [F1500CA10](#) [1B1](#) [FN2020A-10-06](#) [FN2020B-3-06](#)  
[FN2060A-3-06](#) [FN2070A-16-06](#) [FN2070B-16-08](#) [FN2090B-12-06](#) [FN2090Z-1-06](#) [FN2410H-25-33](#) [FN2410H-60-34](#) [FN2410H-8-44](#)  
[FN2412H-25-33](#) [FN2412H-8-44](#) [FN610R-3-06](#) [20EHZ7](#) [20K1](#) [30B6](#) [30BCF10R](#) [3K1](#) [4-6609089-0](#) [B84142A0016R122](#)