



## LatticeSC™ PCI Express x1 Evaluation Board

---

**User's Guide**

## Introduction

This user's guide describes the LatticeSC PCI Express x1 Evaluation Board featuring the LatticeSC LFSCM3GA25 device in a 900 fpBGA package. The stand-alone evaluation PCB provides a functional platform for development and rapid prototyping of applications that require high-speed SERDES interfaces to PCI Express protocols.

The evaluation board includes provisioning to connect high-speed SERDES channels via SMA connectors to test and measurement equipment. The board is manufactured using standard FR4 dielectric and through-hole vias. The nominal impedance is 50-ohm for single-ended traces and 100-ohm for differential traces.

The board has several debugging and analyzing features for complete evaluation of the LatticeSC device. This user's guide is intended to be referenced in conjunction with evaluation design tutorials to demonstrate the LatticeSC FPGA.

**Figure 1. LatticeSC PCI Express x1 Evaluation Board**

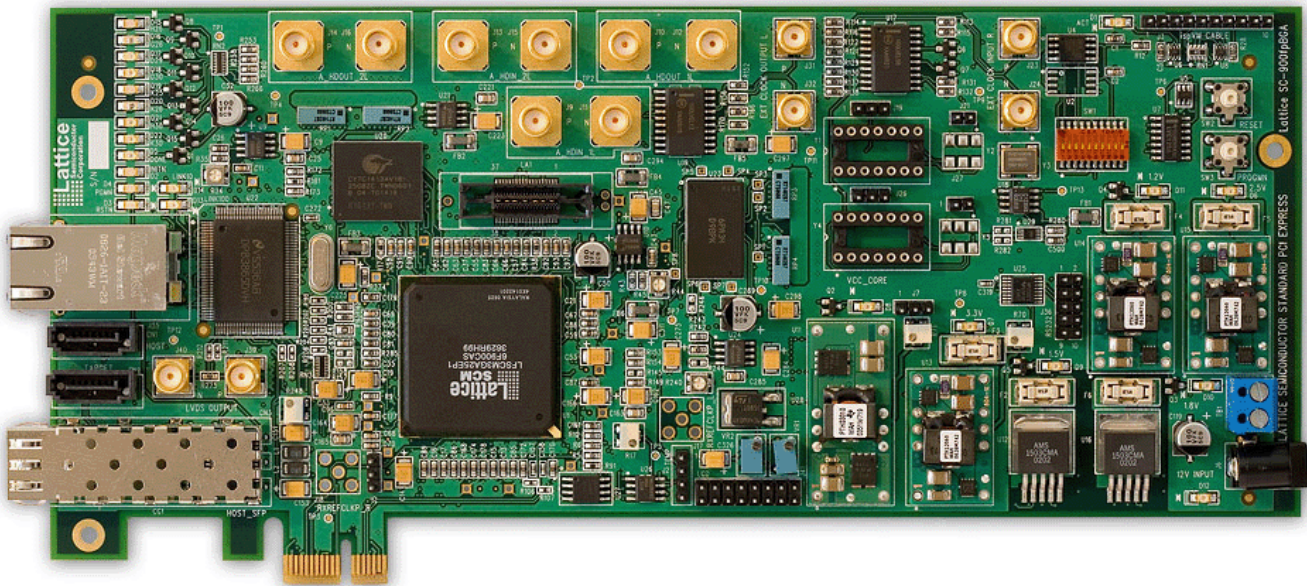

## Features

- Four SERDES high-speed channels interfaced to SMA test points and clock connections SERDES interface to x1 PCI Express edge fingers
- RJ-45 interface for Ethernet
- QDR2 and RLDRAMII memory devices
- SFP Transceiver cage and associated interface
- SATA-like connections to SERDES channels
- Power connections and power sources
- ispVM<sup>®</sup> programming support
- On-board and external reference clock sources
  - Interchangeable clock oscillators
  - On-board reference clock management
- ORCAstra Demonstration Software interface via standard ispVM JTAG connection

- RS-232 Communications Port
- Logic analyzer connection
- Liquid Crystal Display interface connection
- User-defined input and output points
- SMA connectors included for high-speed clock or data interfacing
- Performance monitoring via test headers, LEDs and switches

The contents of this user's guide include top-level functional descriptions of the various portions of the evaluation board, descriptions of the on-board connectors, diodes and switches and a complete set of schematics of the board. Figure 2 shows the functional partitioning of the board.

**Figure 2. LatticeSC PCI Express x1 Evaluation Board Block Diagram**

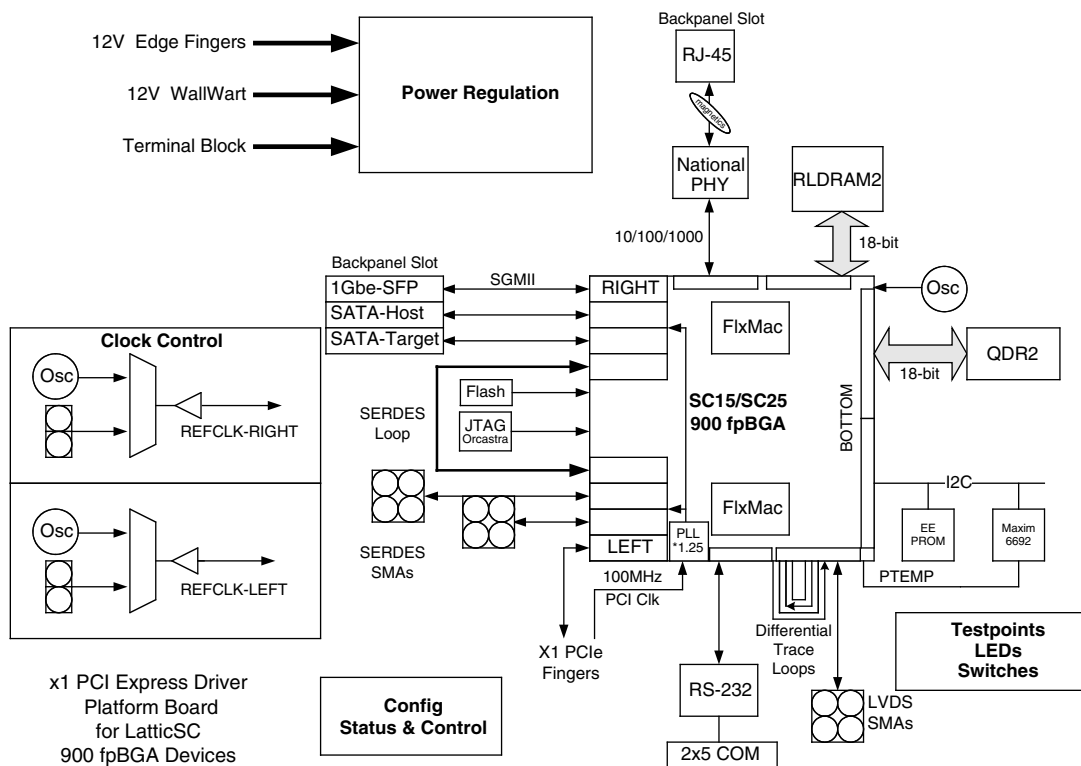

### Additional Resources

For additional information and resources related to this board, including updated documentation and software demos, please see the Lattice web site at: [www.latticesemi.com/boards](http://www.latticesemi.com/boards), and navigate to the appropriate page for this board.

Lattice makes its best effort to provide evaluation board designs to help users with evaluation and development. However it remains the user's responsibility to verify proper and reliable operation of Lattice products in their end application by consulting documentation provided by Lattice. Differences in component selection and/or PCB layout in the user's application may significantly affect circuit performance and reliability.

Figure 3. LatticeSC PCI Express x1 Evaluation Board, Top View

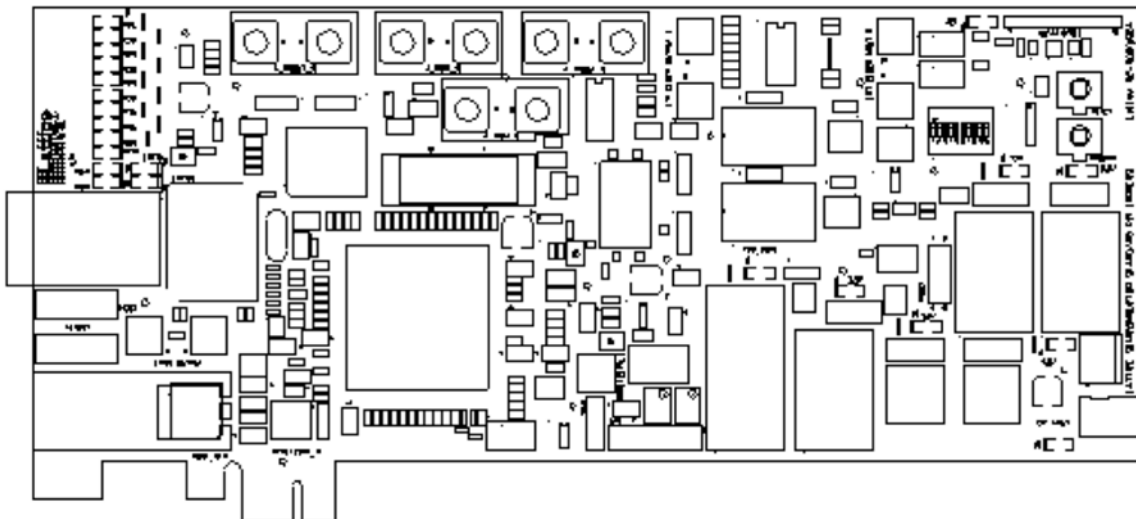

## LatticeSC Device

This board features a LatticeSC FPGA with a 1.2V core supply. It can accommodate all pin compatible LatticeSC devices in the 900-ball fpBGA (1mm pitch) package. A complete description of this device can be found in the LatticeSC Family Data Sheet on the Lattice web site at [www.latticesemi.com](http://www.latticesemi.com).

*Note: The connections referenced in this document refer to the LFSCM3GA25EP1-XXF900 device. Available I/Os and associated sysIO™ banks may differ for other densities within this device family.*

## Applying Power to the Board

The LatticeSC PCI Express x1 Evaluation Board is ready to power on. The board can be supplied with power from an AC wall-type transformer power supply shipped with the board or it can be supplied from a bench top supply via terminal screw connections. It also has provisions to be supplied from the PCI Express edge fingers from a host board.

To supply power from the factory-supplied wall transformer, simply connect the output connection of the power cord to J6 and plug the wall transformer into an AC wall outlet.

## Power Supplies

(see Appendix A, Figure 6)

The evaluation board incorporates an alternate scheme to provide power to the board. The board is equipped to accept a main supply via the TB1 connection. This connection is provided to use with a bench top supply adjusted to provide a nominal 12V DC.

All input power sources and on-board power supplies are fused with surface mounted fuses and have green LEDs to indicate power GOOD status of the intermediate supplies

**Table 1. Board Power Supply Fuses (see Appendix A, Figure 6)**

F1	1.0V/1.2V Core Fuse
F2	1.5V Fuse
F3	3.3V Fuse
F4	1.2V Fuse
F5	2.5V Fuse
F6	1.8V Fuse

**Table 2. Board Power Supply Indicators (see Appendix A, Figure 6)**

D6	2.5V Source Good Indicator
D7	3.3V Source Good Indicator
D8	1.0V/1.2V VCC Core Source Good Indicator
D9	1.5V Source Good Indicator
D10	1.8V Source Good Indicator
D11	1.2V Source Good Indicator
D12	12V Input Good Indicator

**Table 3. Board Supply Disconnects (see Appendix A, Figure 7)**

TB1	Screw Terminal for 12V DC
	Pin 1 (Square PCB Pad) = 12V DC
	Pin 2 = Ground

## PCI Express Power Interface

Power can be sourced to the board via the PCB edge-finger (CN1). This interface allows the user to provide power from a PCI Express host board.

## VCC Core Selection

(see Appendix A, Figure 6)

The VCC core can be selected on the board to be either 1.0V or 1.2V using J7.

A jumper shunt placed between pin 1 and pin 2 will connect 1.0V. A jumper shunt between pin 2 and pin 3 will connect 1.2V.

## Programming/FPGA Configuration

(see Appendix A, Figure 5)

A programming header is provided on the evaluation board, providing access to the LatticeSC JTAG port.

**Important Note:** The board must be un-powered when connecting, disconnecting, or reconnecting the ispDOWNLOAD Cable. Always connect the ispDOWNLOAD Cable's GND pin (black wire), before connecting any other JTAG pins. Failure to follow these procedures can result in damage to the LatticeSC FPGA device and render the board inoperable.

An ispDOWNLOAD® Cable is included with this board and also with each ispLEVER® design tool shipment. Cables may also be purchased separately from Lattice.

## ispVM Download Interface

J3 is an 10-pin JTAG connector used in conjunction with the ispVM USB download cable to program and control the device. Connections to the cable typically consist of Pin[1:2:3:6:7:8]. The other pins are considered optional and are not required to be connected for standard operation.

**Table 4. ispVM JTAG Connector (see Appendix A, Figure 5)**

Pin 1	VCC
Pin 2	TDO
Pin 3	TDI
Pin 4	PROGRAMN <sup>1</sup>
Pin 5	NC
Pin 6	TMS
Pin 7	GND
Pin 8	TCK
Pin 9	DONE <sup>1</sup>
Pin 10	INITN <sup>1</sup>

1. Optional pins.

## Download Procedures

### Requirements

- PC with ispVM System v.16.0 (or later) programming management software, installed with appropriate drivers (USB driver for USB Cable, Windows NT/2000/XP parallel port driver for ispDOWNLOAD Cable). The latest ispVM System software can be downloaded from the Lattice web site at [www.latticesemi.com/ispvm](http://www.latticesemi.com/ispvm).

*Note: An option to install these drivers is included as part of the ispVM System setup.*

- ispDOWNLOAD Cable

### JTAG Download

The LatticeSC device can be configured easily via its JTAG port. The device is SRAM-based; it must remain powered on to retain its configuration when programmed in this fashion.

1. Connect the ispDOWNLOAD cable to the appropriate header. J3 is used for the 1x10 cable. Connections to J3 use only pins[1-3][6-8].
2. Connect the LatticeSC PCI Express x1 evaluation board to the appropriate power sources and power up board.
3. Start the ispVM System software.

- Press the **SCAN** button located in the toolbar. The LatticeSC device is automatically detected.

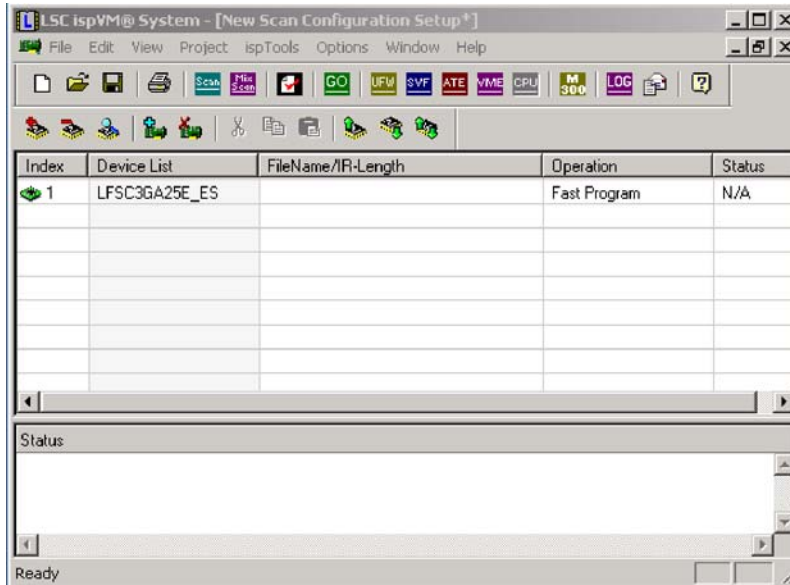

- Double-click the device to open the device information dialog. In the device information dialog, click the **Browse** button located under **Data File**. Locate the desired bitstream file (.bit). Click **OK** to both dialog boxes.

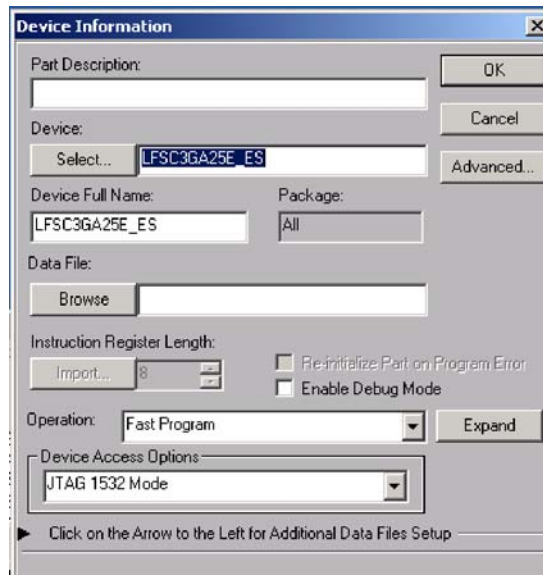

- Click the green **GO** button. This will begin the download process into the device. Upon successful download, the device will be operational.

### Configuration Status Indicators

(see Appendix A, Figure 5)

These LEDs indicate the status of configuration to the FPGA.

- D2 (RED) illuminated: This indicates that the programming was aborted or reinitialized driving the INITN output low.

- D5 (GREEN) is illuminated: This indicates the successful completion of configuration by releasing the open collector DONE output pin.
- D1 (GREEN) will flash indicating TDI activity.
- D4 (RED) illuminated: This indicates that PROGRAMN is low.
- D3 (RED) illuminated: This indicates that GSRN is low.

## PROGRAMN and GSRN

(see Appendix A, Figure 5)

These push-button switches assert/de-assert the logic levels on the PROGRAMN (SW3) and GSRN (SW2). Depressing the button drives a logic level "0" to the device.

## Bank1 VCCIO

(see Appendix A, Figure 6)

VCCIO1 can be selected on the board to be either 3.3V or 2.5V using J5.

A jumper shunt placed between pin 1 and pin 2 will connect 2.5V. A jumper shunt between pin 2 and pin 3 will connect 3.3V.

## On-Board Flash Memory

(see Appendix A, Figure 5)

Two memory devices (U2 and U3) are on-board for non-volatile configuration memory storage. These two devices occupy the same Flash slot on the board. U2 can be populated with an 8M or smaller 8-pin SOIC device. U3 can be used in place of U2 with a 16-pin TSSOP 64M Flash device. This is the factory supplied Flash memory configuration. U4 is always supplied as an 8M Flash device. SW1 is used to control the selection of the Flash memory to be accessed.

Refer to Lattice technical note TN1100, *SPI Serial Flash Programming Using ispJTAG™ on LatticeSC FPGAs* for recommended procedures and software usage. To use both SPI Flash devices to program the LatticeSC device, the user must write to the Flash devices individually. This is accomplished by setting SW1 accordingly. Writing to Flash #1(U2 OR U3), close 3 and 5 switch positions (ON) and open all others. Writing to Flash #2(U4), close 2 and 4 switch positions (ON) and open all others. For reading from the Flash devices individually, use the same switch settings as described for writing. For reading from both Flash devices in cascading format, close switch positions (1, 3, 4, 5, 8).

## FPGA Clock Management

(see Appendix A, Figures 10 and 11)

The evaluation board includes various features for generating and managing on-board clocks. The clocks are generated from either input provided from SMAs (see Table 5) or from crystal oscillators (Y1 and Y4). Y1 and Y4 are socketed for interchangeability. Y2 and Y5 are 321.25MHz surface-mounted oscillators. The Y3 oscillator is fanned out around U1 for reference clocks with a fan-out buffer IC.

Y1 and Y4 can be a 4-pin DIP type oscillator like Connor-Winfield XO-400 series.

Clock oscillators are selected per quad. Y1 and Y2 can source a clock to the Right SERDES Quads. Y4 and Y5 can source a clock to the Left SERDES Quad. The user needs to select the appropriate oscillator by placing jumper shunts on J20 and/or J22 for the Left reference clock source or J25 and/or J28 for the Right reference clock source. The selection of these clock sources is dependent on the selection pins of the clock multiplexers. The mux select pins are driven from the FPGA and will need to be driven according to the needs of the user design. The following table defines the selection of the clock sources.



**Table 5. Clock Source Selection (see Appendix A, Figures 5 and 10)**

BGA-A19	BGA-A20	Right Clock Source	Left Clock Source
L	L	SMA	SMA
H	H	Oscillator	Oscillator

Pin is low when open/float. FPGA general purpose I/O must be driven to control the mux selection.

When using FPGA control, 3.3V VCCIO must be used in bank 1. Refer to Bank1 VCCIO section of this document.

**Table 6. Clock Input SMA (see Appendix A, Figure 10)**

SMA	Signal
J29	SMA Reference + Input to Left Quad
J30	SMA Reference - Input to Left Quad
J23	SMA Reference + Input to Right Quad
J24	SMA Reference - Input to Right Quad

The clocks sources are fanned-out across the board to several destinations. These clocks are all differential and must be used accordingly. These include SERDES reference clocks, PLL, and primary clock inputs.

**Table 7. Clock Distribution (see Appendix A, Figure 11)**

Clock Net	BGA	Clock Destination
FPGA_REFCLKP_L	P8	PCLKT7_2
FPGA_REFCLKN_L	R8	PCLKC7_2
FPGA_REFCLKP_R	AD26	LRC_PLLB_T
FPGA_REFCLKN_R	AC25	LRC_PLLB_C
A_REFCLKP_L	B1	SERDES[360]
A_REFCLKN_L	C1	SERDES[360]
A_REFCLKP_R	B30	SERDES[3e0]
A_REFCLKN_R	C30	SERDES[3e0]

The clocks are also driven to SMA connections for driving off-board.

**Table 8. Clock Output SMAs (see Appendix A, Figure 11)**

Net Name	SMA	SMA
EXTCLOCK_L	J31	J32
EXTCLOCK_R	J33	J34

## SERDES Reference Clock

The 50-ohm terminated SMA connectors are provided the supply reference clocks directly to the LatticeSC device from the clock management device. This device will drive clocks to both SERDES quads via 100-ohm LVDS signaling. On-board clock oscillators mentioned in the previous sections can be chosen to drive the same SERDES reference clocks. Also the board can be provisioned to source the clock from the PCI Express edge-fingers directly to FPGA input pins.

Both of these input clock sources are routed through clock management devices allowing for clock source selection from a SMA input connector. This is accomplished by using the MUX selector driven by the FPGA output.

## SERDES Channels

### SMA Connections

(see Appendix A, Figure 5)

DC coupled top-mounted SMA connectors connect to the two SERDES TX and RX channels. These pins are directly coupled to the designated SMA connector creating a path for both input and output differential data.

**Table 9. SERDES Connectors (see Appendix A, Figure 8)**

SMA	Channel Name	900-Ball fpBGA	SMA	Channel Name	900-Ball fpBGA
J13	A_HDINP1_LEFT	B6	J10	A_HDOUTP1_LEFT	A6
J15	A_HDINN1_LEFT	B5	J12	A_HDOUTN1_LEFT	A5
J9	A_HDINP2_LEFT	B7	J14	A_HDOUTP2_LEFT	A7
J11	A_HDINN2_LEFT	B8	J16	A_HDOUTN2_LEFT	A8

### SERDES SFP Transceiver Interface

(see Appendix A, Figure 8)

A small form-factor pluggable (SFP) transceiver cage is included for evaluation of SFP specific protocols. The PCB includes the appropriate power and high-speed circuitry needed for the SFP standard transceiver.

**Table 10. SFP Connections to SERDES Pins (see Appendix A, Figure 5)**

SFP RX	Channel Name	900-Ball fpBGA	SFP TX	Channel Name	900-Ball fpBGA
RD+	A_HDINP0_RIGHT	B28	TD+	A_HDOUTP0_RIGHT	A28
RD-	A_HDINN0_RIGHT	B27	TD-	A_HDOUTN0_RIGHT	A27

**Table 11. SFP Control and Status Connections to FPGA**

SFP Pin	900-Ball fpBGA	SFP Pin	900-Ball fpBGA
TxFault	A15	ModeDef0	E15
TxDis	C13	ModeDef1	D15
LOS	G15	ModeDef3	C14
RateSel	F15		

### SERDES SATA Channels

(see Appendix A, Figure 8)

AC-coupled connections are included to attach SATA type cables to SERDES channels for board-to-board or loop-back purposes. The connectors are configured using the 7-pin SATA specifications.

**Table 12. SERDES to SATA Connections**

CN1 Pin	SERDES Pin	900-Ball fpBGA		CN2 Pin	SERDES Pin	900-Ball fpBGA
1	—	GND		1	—	GND
2	A_HDOUTP1_R	A25		2	A_HDINP2_R	B24
3	A_HDOUTN1_R	A26		3	A_HDINN2_R	B23
4	—	GND		4	—	GND
5	A_HDINP1_R	B25		5	A_HDOUTP2_R	A24
6	A_HDINN1_R	B26		6	A_HDOUTN2_R	A23
7	—	GND		7	—	GND

**SERDES PCI Express Channels**

(see Appendix A, Figure 8)

This board is equipped to communicate directly as an add-on card to a PCI Express host. It is designed with edge-fingers (CN1) to fit directly into an x1 host receptacle. Power can be supplied directly from the PCI Express host via the edge-finger connections.

**Table 13. SERDES to PCI Express Connections**

PCI Express Pin	PCI Express Signal	SCM Device Pin	900-Ball fpBGA
B14	PETp0	A_HDINP0_L	B3
B15	PETn0	A_HDINN0_L	B4
A16	PERp0	A_HDOUTP0_L	A3
A17	PERn0	A_HDOUTN0_L	A4
A13	Refclk+	FPGA URC_A PLL Input+	D28
A14	Refclk-	FPGA URC_A PLL Input+	E28

**FPGA Test Pins**

(see Appendix A, Figure 15)

General purpose FPGA pins are available for user applications. FPGA pins are connected to SW4 DIP switch. This switch is used for static settings to FPGA input pins. The pins must be set to LVCMOS18 buffer types and are externally pulled up when the switch is open and driven low when the switch is set to "ON" or closed.

General purpose outputs are connected to LEDs for observing output status of pins. The FPGA output buffers should be LVCMOS18 and will illuminate the LED when driving a "1" and the LED will be off when driving a "0" or when not used.

**Table 14. FPGA Test Pins (see Appendix A, Figure 15)**

Switch	BGA	Netname	LED	900-Ball fpBGA	NetName	LED Color
SW4A	G28	Switch1	D15	H26	LED1	Red
SW4B	F28	Switch2	D16	G26	LED2	Yellow
SW4C	L25	Switch3	D17	D29	LED3	Green
SW4D	L26	Switch4	D18	D30	LED4	Blue
SW4E	E29	Switch5	D19	K25	LED5	Red
SW4F	E30	Switch6	D20	K26	LED6	Yellow
SW4G	J28	Switch7	D21	H30	LED7	Green
SW4H	H28	Switch8	D22	K30	LED8	Blue

## Test SMA Connections

General-purpose FPGA pins are available via SMA test connections. These connections are designed to permit evaluations of several types of FPGA I/O buffers. The use of several termination schemes permits easy interfaces for the type of buffer.

**Table 15. Test SMA Connections for FPGA Pins (see Appendix A, Figure 16)**

SMA Designation	Name	SCM25 Signal	900-Ball fpBGA	Termination Description	Termination Resistor(s)
J37	LVDS_INP	PR52A	AB28	None	—
J39	LVDS_INN	PR52B	AC28	None	—
J38	LVDS_OUTP0	PR35A	M29	100-ohm Differential	R275
J40	LVDS_OUTN0	PR35B	N30	100-ohm Differential	R275

## High Speed Test Point

### DP2

(see Appendix A, Figure 15 and 16)

General-purpose FPGA pins are available via a differential test pad. These connections allow a high-impedance probe to measure the performance of a coupled-differential output buffer pair.

**Table 16. Differential I/O Test Point**

Probe True	Probe Compliment	100-ohm Differential Resistor
AF30	AG30	R274

## Logic Analysis Connection

### LA1

(see Appendix A, Figure 15 and 16)

Agilent single-ended probes designed for connection to the supplies Tyco/AMP's 2-767004-2 MICTOR connector can be easily attached for signal bus analysis. Connections to general-purpose I/O pins are provided to the board ready 38-pin MICTOR connector.

**Table 17. Logic Analyzer Connections**

MICTOR Pin	Signal	900-Ball fpBGA	MICTOR Pin	Signal	900-Ball fpBGA
5	LA_CLK1	AJ1	6	LA_CLK2	AF4
7	LA_0	AG3	8	LA_16	AH13
9	LA_1	AH2	10	LA_17	AK8
11	LA_2	AD8	12	LA_18	AK9
13	LA_3	AF7	14	LA_19	AH14
15	LA_4	AJ7	16	LA_20	AG14
17	LA_5	AJ8	18	LA_21	AK10
19	LA_6	AH10	20	LA_22	AK11
21	LA_7	AH11	22	LA_23	AH15
23	LA_8	AF13	24	LA_24	AG15
25	LA_9	AE14	26	LA_25	AH12

**Table 17. Logic Analyzer Connections (Continued)**

MICTOR Pin	Signal	900-Ball fpBGA	MICTOR Pin	Signal	900-Ball fpBGA
27	LA_10	AK6	28	LA_26	AJ13
29	LA_11	AK7	30	LA_27	AD15
31	LA_12	AF14	32	LA_28	AE15
33	LA_13	AF15	34	LA_29	AK12
35	LA_14	AJ11	36	LA_30	AK13
37	LA_15	AG13	38	LA_31	AJ14

## RS-232 Interface

### J36

(see Appendix A, Figures 5 and 16)

A simple 2x5 Header provides a connection to create a RS-232 serial communications port. The connection includes the proper level shift needed to connect to a serial port of a PC. The RX and TX pins are connected to the FPGA.

**Table 18. RS-232 TX/RX**

Signal	900-Ball fpBGA	Buffer Type
RS232-RXD	F13	LVC MOS25
RS232-TXD	F12	LVC MOS25

## LCD Interface

### J41

(see Appendix A, Figures 5 and 16)

A 2x8 Header provides a connection to 16-character x 2 line LCD modules such as Varitronix VDM16265. A ribbon cable connection will allow attachment to the connector. The board includes two variable resistors for LCD adjustments. VR1 adjusts the backlight and VR2 provides contrast adjustment. A user design must be included in the FPGA to drive this feature.

## I<sup>2</sup>C Interface

(see Appendix A, Figures 5 and 16)

I<sup>2</sup>C interface is supplied between the FPGA and two ICs. This interface is used to access a Maxim temperature sensing device as well as a EEPROM. The temperature-sensing device is also connected back to the FPGA via the PTEMP pins to monitor device temperature.

**Table 19. I<sup>2</sup>C Interface**

Signal	900-Ball fpBGA	Buffer Type
SCL	B11	LVC MOS25 or LV TTL33
SDA	B12	LVC MOS25 or LV TTL33

## Ethernet Interface

(see Appendix A, Figures 5 and 13)

Interconnection to Base 10/100/1000 Ethernet protocols is supported via a RJ-45 connection (J35). This connection is electrically interfaced to the FPGA through a tri-speed PHY device. Use of this interface requires a MAC

design to be included in the FPGA. The board includes two status LEDs to indicate Base 10 or Base 100 link. LED(D13) is a green LED which will light to indicate a Base100 link and LED(D14) indicates an established Base 10 link. LED indicators on the RJ-45 connector will indicate activity and Base 1000 link status. Table 20 defines the pinout between the FPGA and PHY device.

**Table 20. LatticeSC FPGA to Ethernet PHY Connections**

Signal	900-Ball fpBGA
ETH_TX_D0	D3
ETH_TX_D1	D2
ETH_TX_D2	J6
ETH_TX_D3	J5
ETH_TX_D4	E3
ETH_TX_D5	E2
ETH_TX_D6	K4
ETH_TX_D7	J4
ETH_RX_D0	F3
ETH_RX_D1	G3
ETH_RX_D2	K5
ETH_RX_D3	K6
ETH_RX_D4	F2
ETH_RX_D5	F1
ETH_RX_D6	E1
ETH_RX_D7	D1
ETH_CRS	K3
ETH_COL	L3
ETH_RX_CLK	L6
ETH_RX_DV	M6
ETH_TX_EN	J1
ETH_TX_CLK	K1
ETH_GTX_CLK	L1
ETH_CLK_TO_MAC	M1

## QDR2 Memory Interface

(see Appendix A, Figures 12 and 15)

Interconnection to a Cypress CY7C1413AV18-2Mx18 QDR2 SRAM memory device is supplied on board. It includes the proper termination and interface requirements needed to operate at speed.

**Table 21. QDR2 Memory Interface Pinouts**

NetName	FPGA Ball	NetName	FPGA Ball	NetName	FPGA Ball
A_0	T30	Q_0	AG29	D_0	AK16
A_1	W28	Q_1	AG28	D_1	AK17
A_2	U26	Q_2	AH30	D_2	AJ16
A_3	U28	Q_3	AJ30	D_3	AJ17
A_4	M30	Q_4	AH29	D_4	AE16
A_5	R29	Q_5	AJ29	D_5	AH16
A_6	P29	Q_6	AE25	D_6	AG16

**Table 21. QDR2 Memory Interface Pinouts (Continued)**

NetName	FPGA Ball	NetName	FPGA Ball	NetName	FPGA Ball
A_7	P27	Q_7	AH28	D_7	AK18
A_8	N29	Q_8	AJ28	D_8	AK19
A_9	N28	Q_9	AE22	D_9	AH17
A_10	R25	Q_10	AK29	D_10	AH18
A_11	R28	Q_11	AK28	D_11	AG17
A_12	N27	Q_12	AH21	D_12	AJ18
A_13	L30	Q_13	AH23	D_13	AJ19
A_14	J30	Q_14	AH22	D_14	AK20
A_15	M26	Q_15	AG22	D_15	AK21
A_16	G29	Q_16	AG21	D_16	AF18
A_17	F29	Q_17	AF21	D_17	AG18
R_N	AA30				
W_N	Y30				
CQ	AK24				
K	AJ20				
K_N	AJ21				

## RLDRAM-II Memory Interface

(see Appendix A, Figures 14 and 15)

Interconnection to a Micron MT49H16M18CFM-25 SDRAM memory device is supplied on board. It includes the proper termination and interface requirements needed to operate at speed.

**Table 22. LatticeSC FPGA to On-board SDRAM Connections**

NetName	900 Ball fpBGA	NetName	900 Ball fpBGA	NetName	900 Ball fpBGA	NetName	900 Ball fpBGA
A_0	AH4	D_0	V2	Q_0	V1	BA_0	AJ2
A_1	AG5	D_1	W2	Q_1	U5	BA_1	AK2
A_2	AF8	D_2	V5	Q_2	U4	BA_2	AD7
A_3	AG8	D_3	V4	Q_3	T4	CS_N	AH1
A_4	AH3	D_4	Y1	Q_4	T5	DM	AJ12
A_5	AJ3	D_5	AA1	Q_5	U1	QK	AC7
A_6	AF9	D_6	Y2	Q_6	T1	QVLD	N3
A_7	AE10	D_7	AA2	Q_7	V3	DK	AC4
A_8	AK3	D_8	Y3	Q_8	U3	DK_N	AD4
A_9	AJ4	D_9	W3	Q_9	T6	CK	AC3
A_10	AE11	D_10	AB1	Q_10	U2	CK_N	AD3
A_11	AF10	D_11	AC1	Q_11	T2		
A_12	AH7	D_12	W5	Q_12	R4		
A_13	AH8	D_13	Y5	Q_13	R1		
A_14	AE12	D_14	Y6	Q_14	P1		
A_15	AE13	D_15	AD2	Q_15	R2		
A_16	AK4	D_16	AE2	Q_16	P4		
A_17	AK5	D_17	AB5	Q_17	P3		

NetName	900 Ball fpBGA	NetName	900 Ball fpBGA	NetName	900 Ball fpBGA	NetName	900 Ball fpBGA
A_18	AJ5						
A_19	AJ6						

## Ordering Information

Description	Ordering Part Number	China RoHS Environment-Friendly Use Period (EFUP)
LatticeSC PCI Express x1 Evaluation Board	LFSC25E-P1-EV	

## Technical Support Assistance

Hotline: 1-800-LATTICE (North America)  
+1-503-268-8001 (Outside North America)  
e-mail: [techsupport@latticesemi.com](mailto:techsupport@latticesemi.com)  
Internet: [www.latticesemi.com](http://www.latticesemi.com)

## Revision History

Date	Version	Change Summary
October 2006	01.0	Initial release.
December 2006	01.1	Includes new SERDES schematic in Appendix A.
March 2007	01.2	Added Ordering Information section.
April 2007	01.3	Added important information for proper connection of ispDOWNLOAD (Programming) Cables.
November 2008	01.4	Updated FPGA Clock Management text section.
		Updated Clock Source Selection table.
		Updated Clock Input SMA table.
		Updated 10/100/1000 PHY schematic.

© 2008 Lattice Semiconductor Corp. All Lattice trademarks, registered trademarks, patents, and disclaimers are as listed at [www.latticesemi.com/legal](http://www.latticesemi.com/legal). All other brand or product names are trademarks or registered trademarks of their respective holders. The specifications and information herein are subject to change without notice.





Figure 5. Configuration/Top Bank

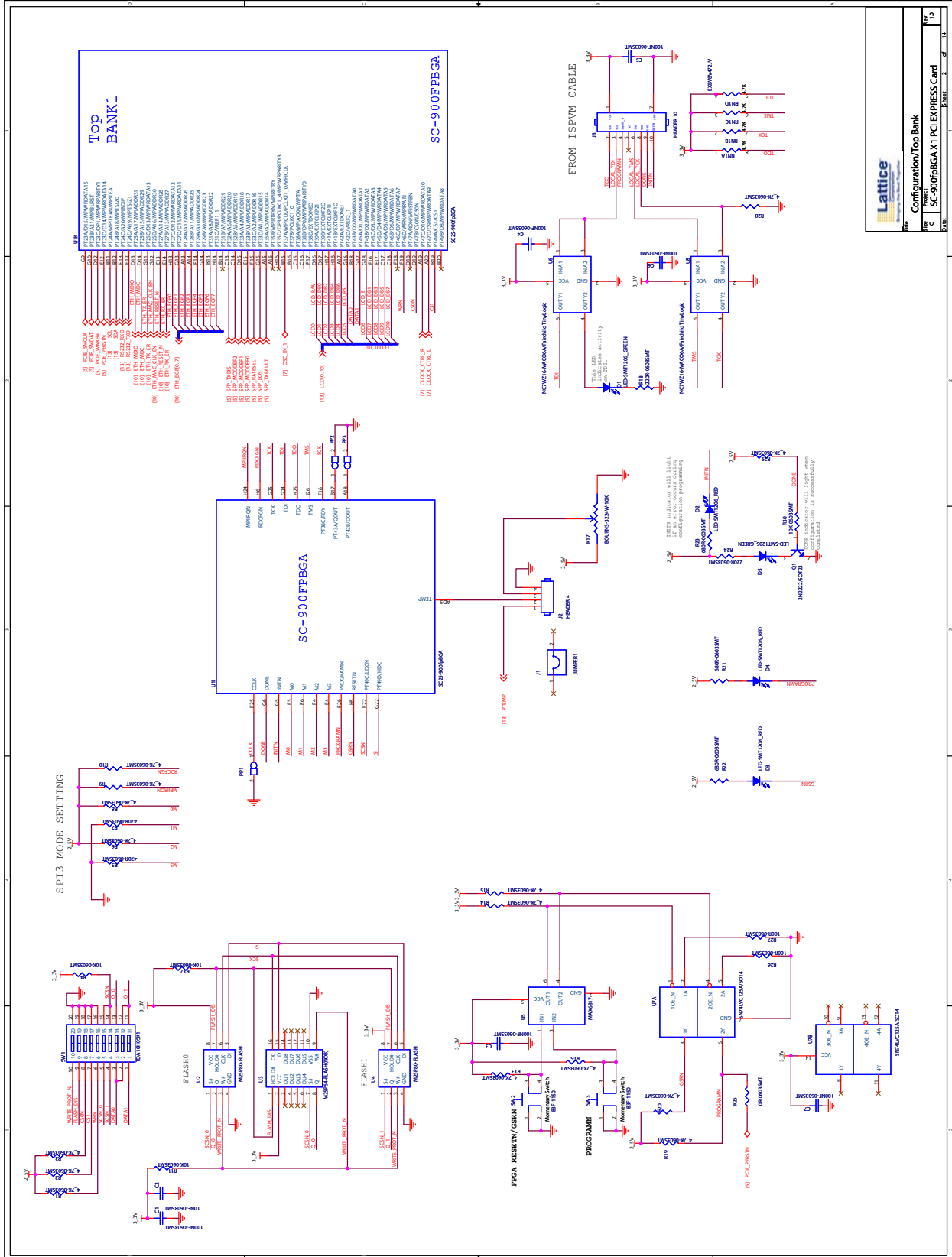

Figure 6. Power Supplies

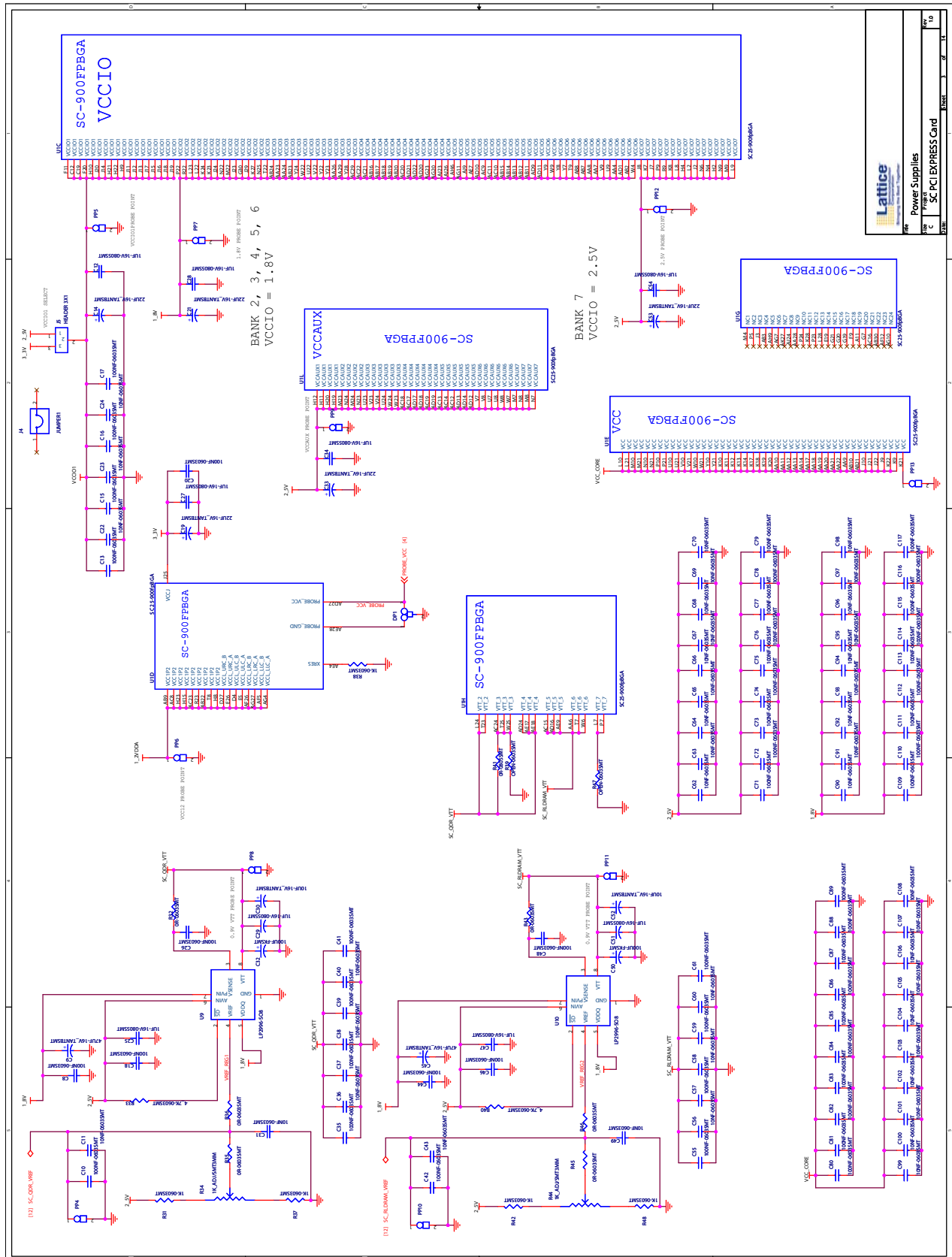



Figure 8. SERDES

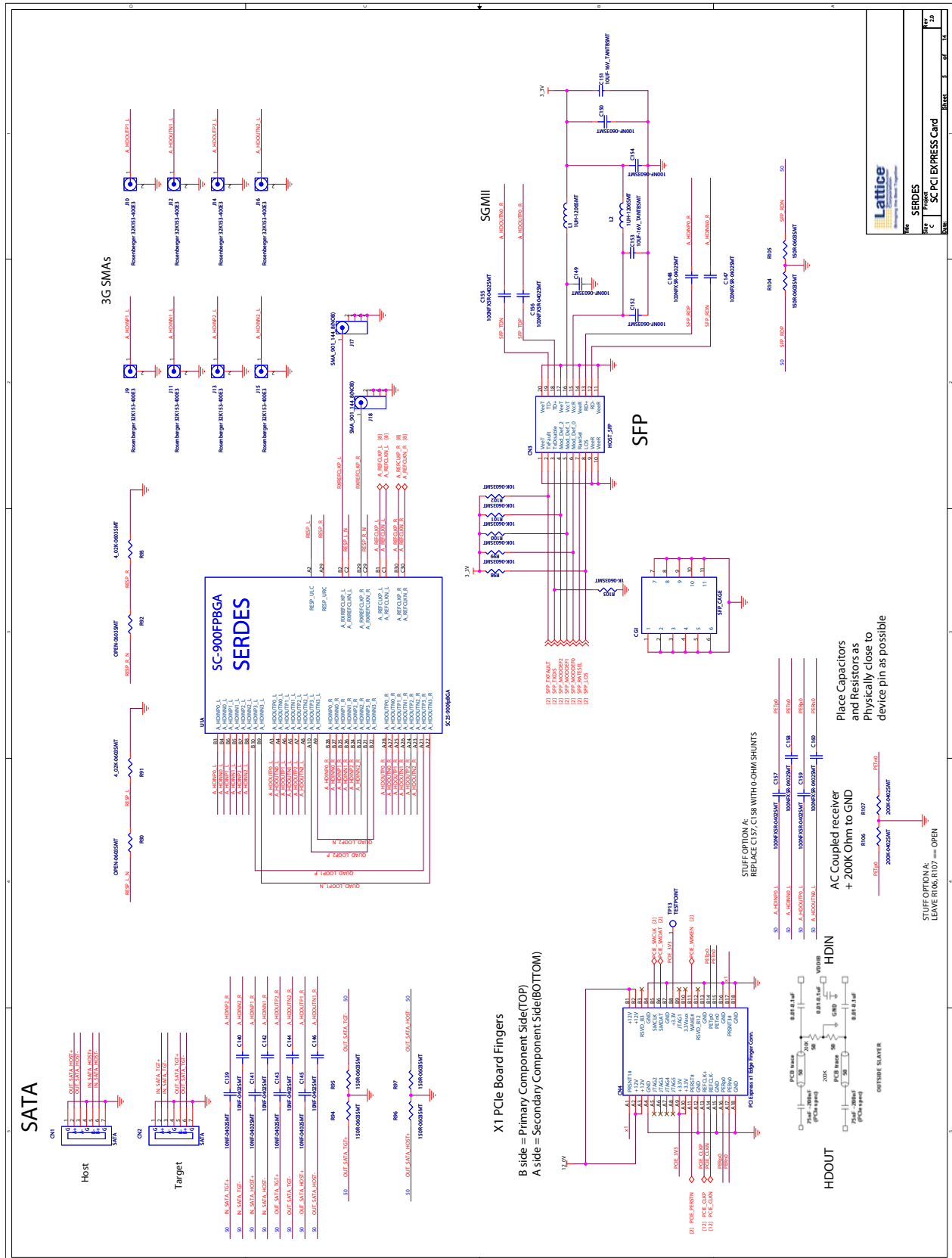

Figure 9. SERDES Power Supplies

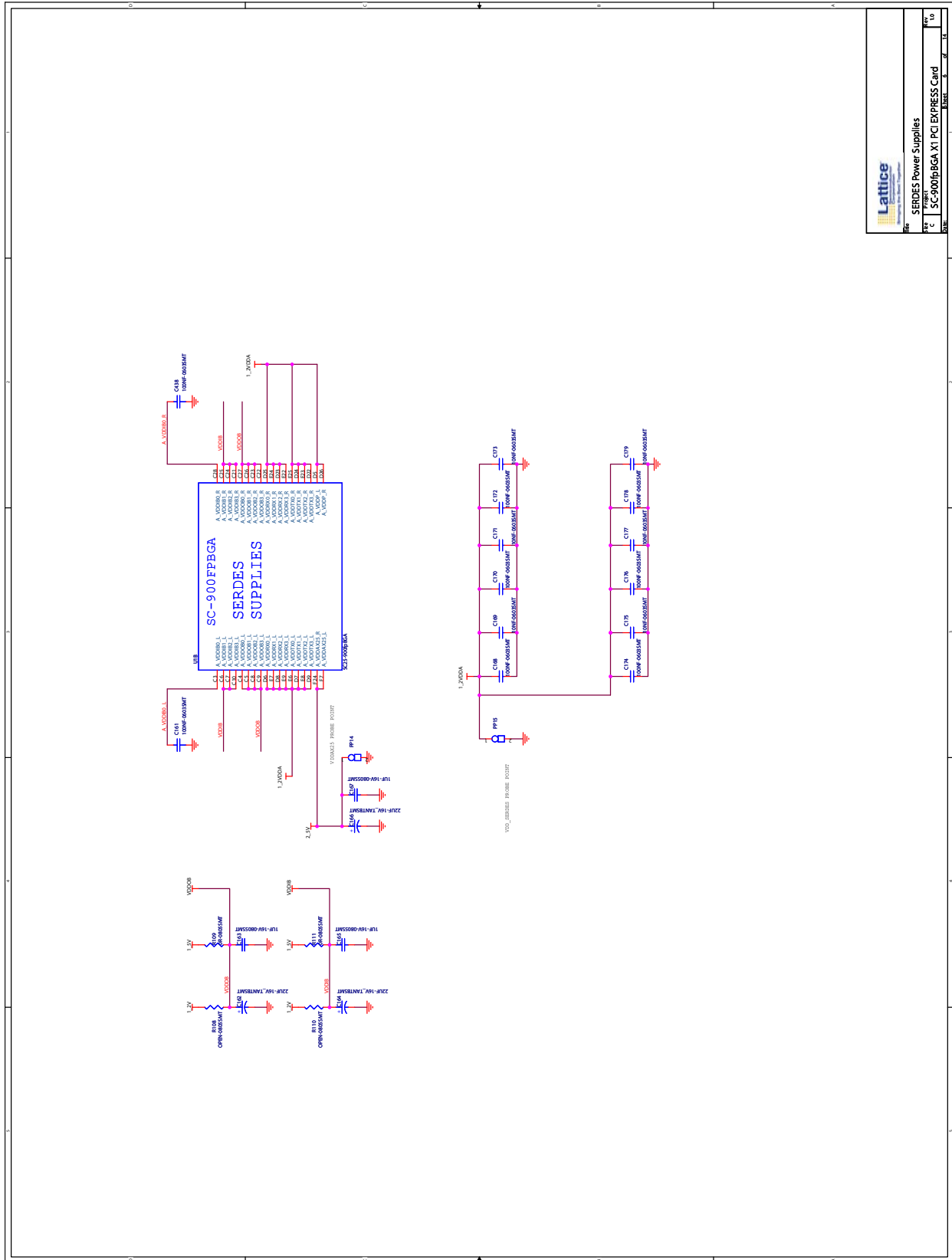

Figure 10. Clocks

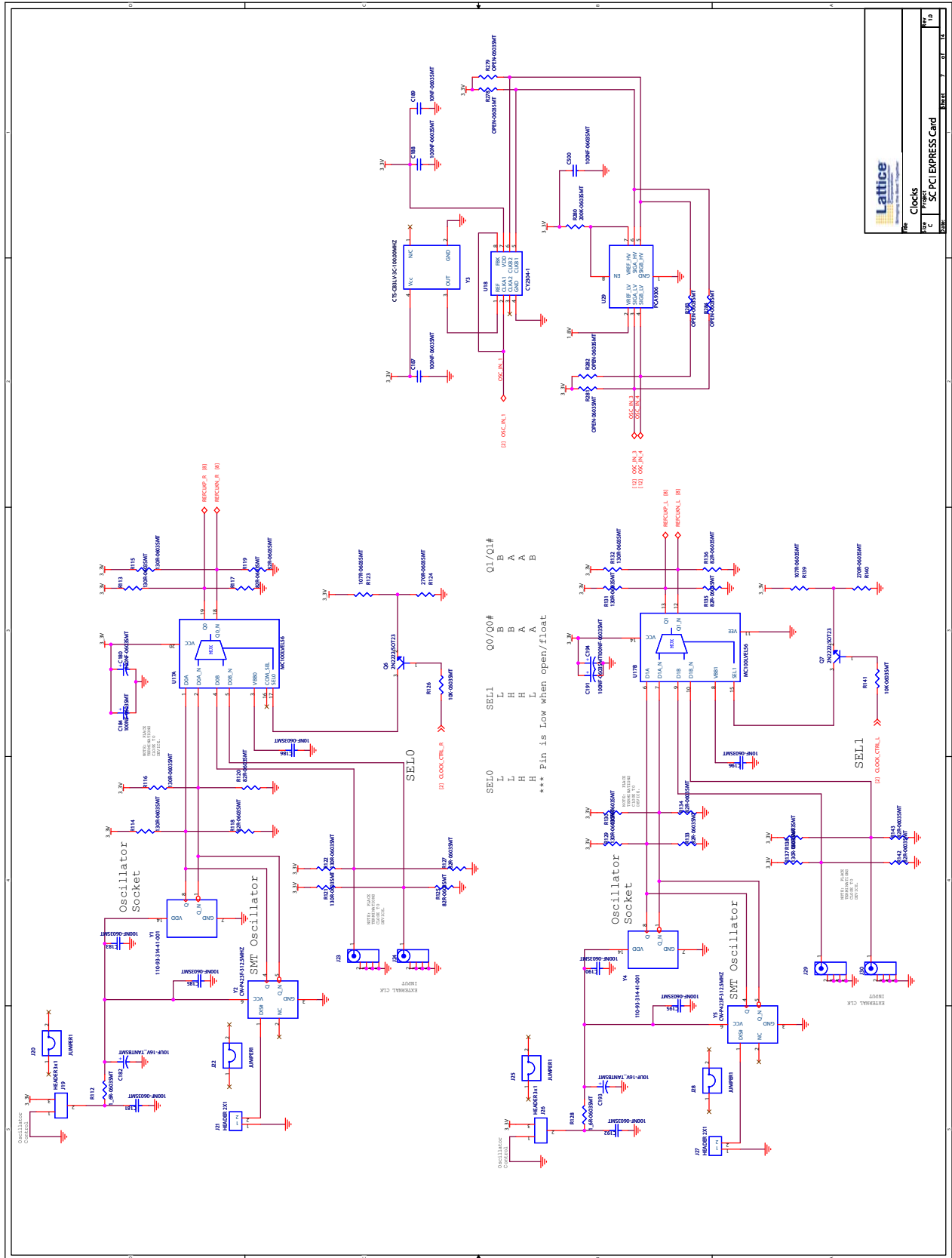
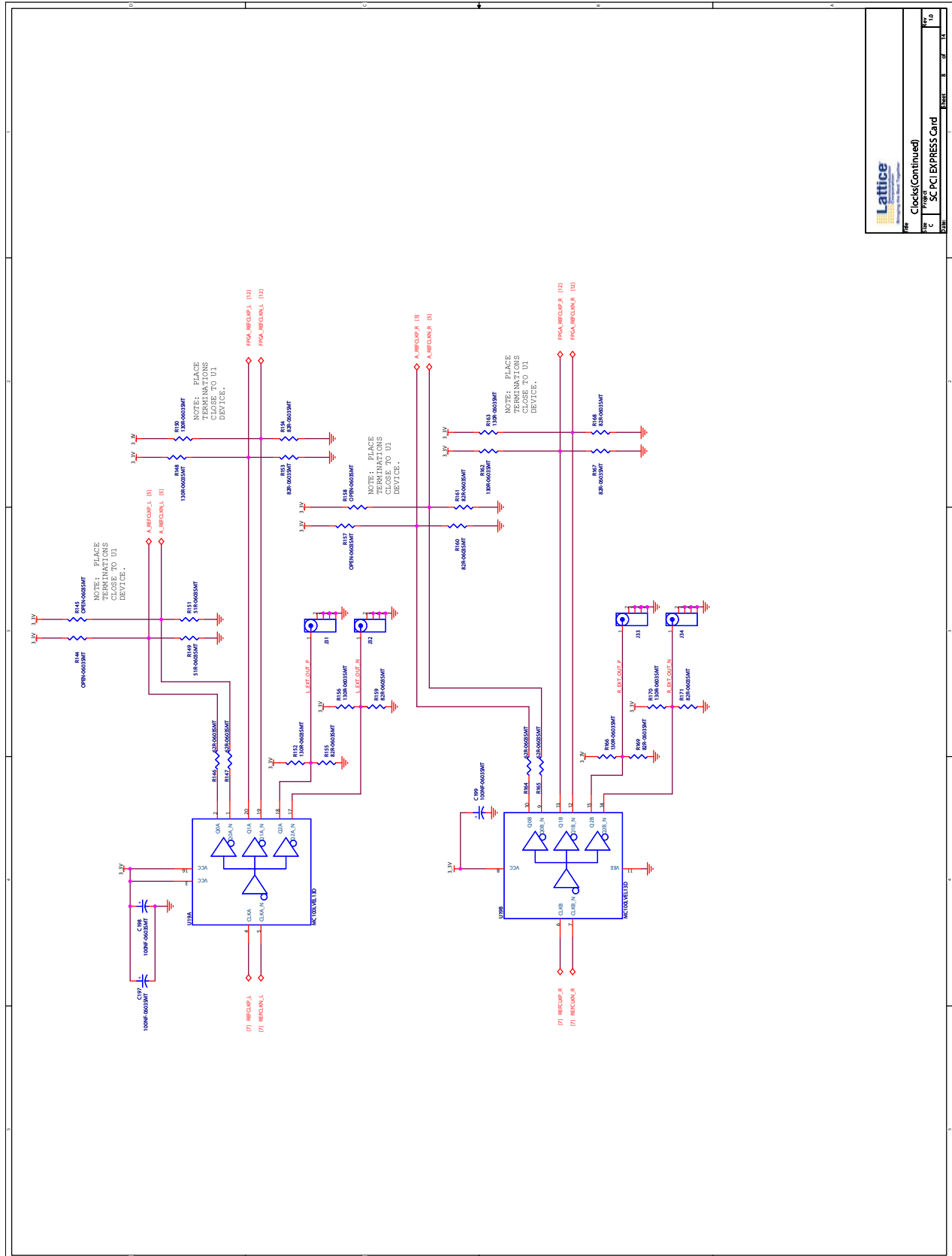



Figure 11. Clocks (Cont.)





  
 Lattice Semiconductor Corporation  
 10660 S. Kirkland Road  
 Portland, OR 97201-3493  
 USA  
 Phone: 503.685.3773  
 Fax: 503.685.3775  
 Email: sales@lattice.com  
 Website: www.lattice.com

Part: Clocks(Continued)  
 Rev: 1.0  
 Date: 08/2010  
 File: PCI\_EXPRESS\_CARD



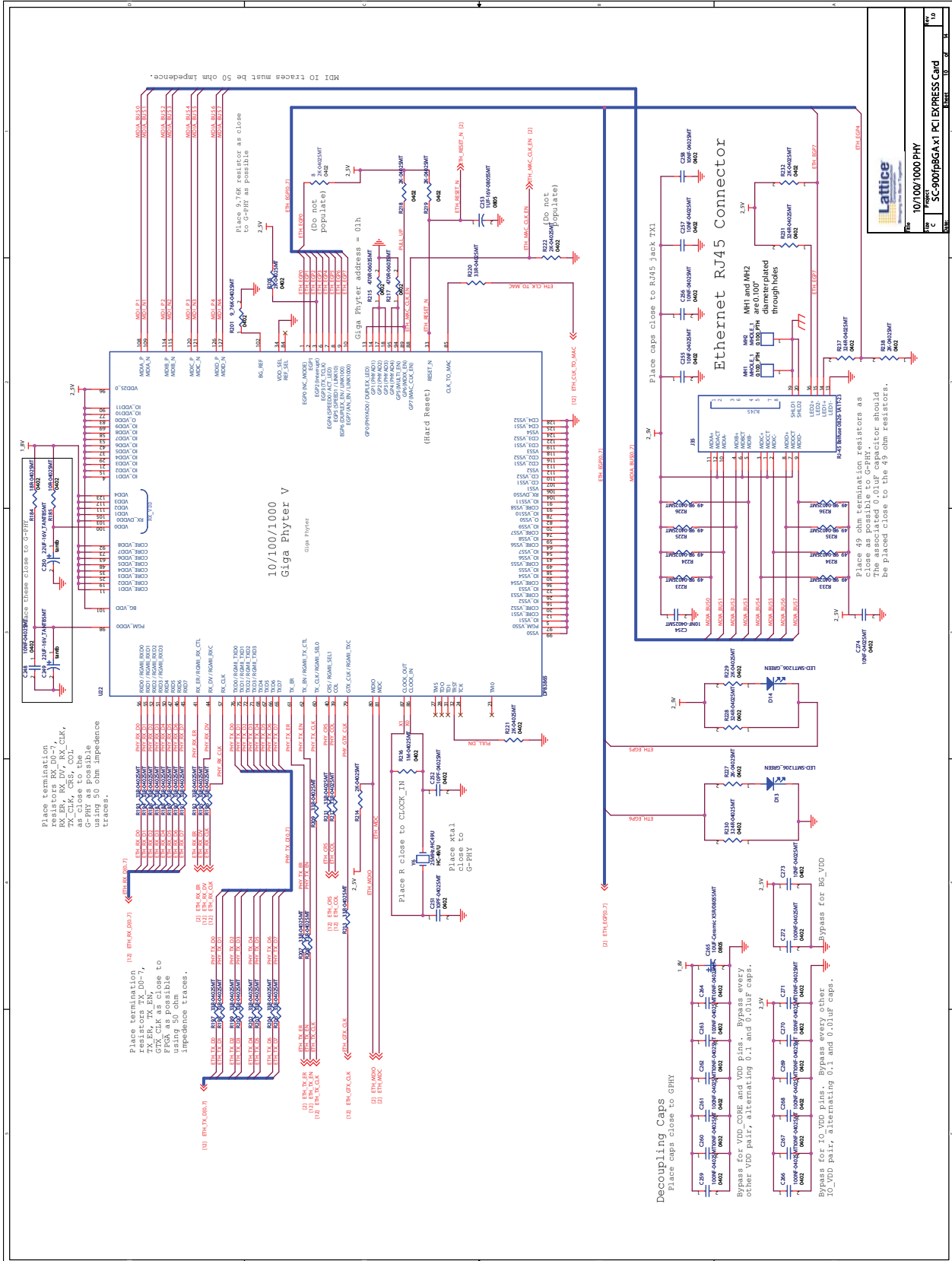

Figure 13. 10/100/1000 PHY



Lattice	
Part	10/100/1000 PHY
Product	SC-9001PBGGA x1 PCI EXPRESS CARD
Rev	1.0

Figure 14. RLDRAM

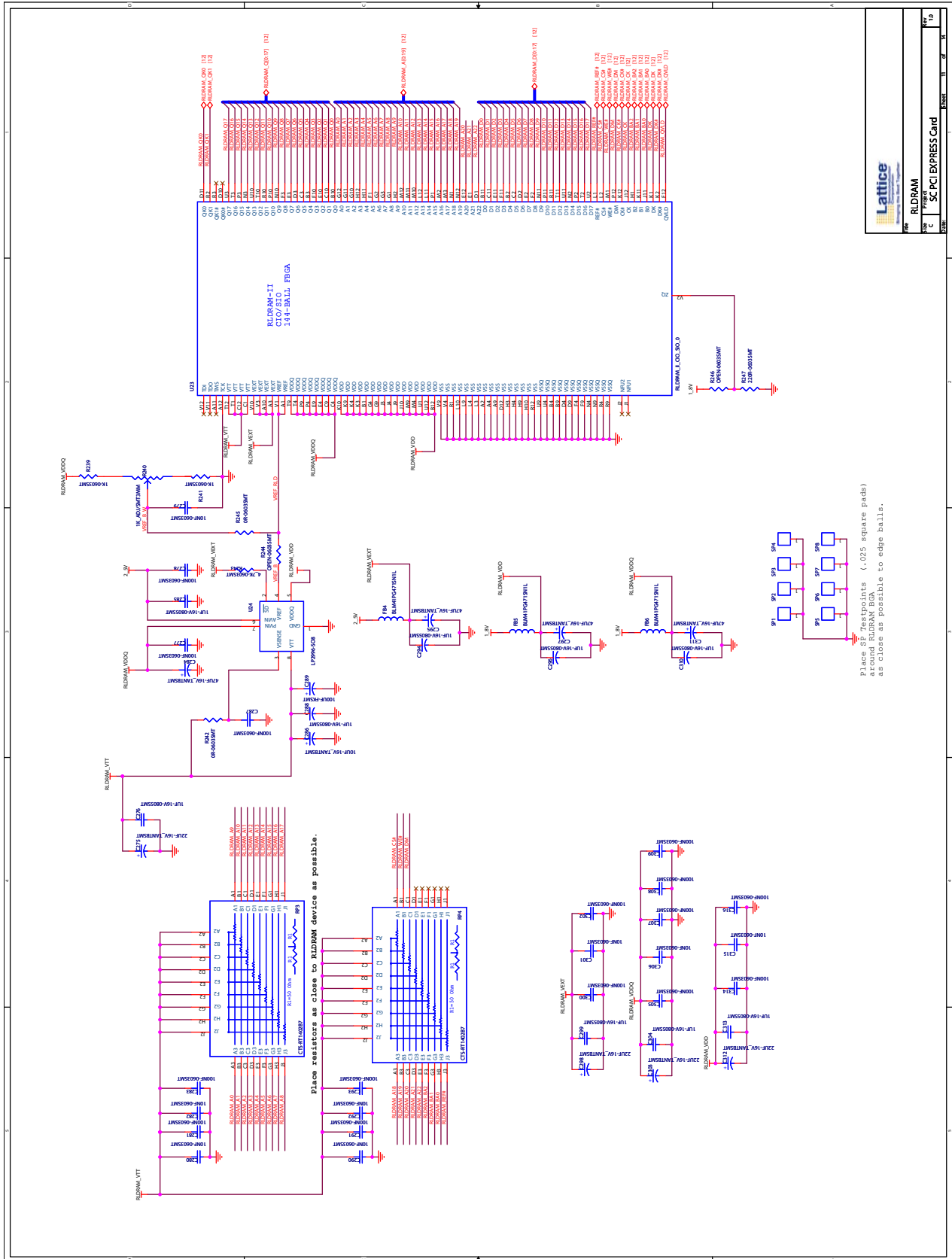

Figure 15. FPGA Banks

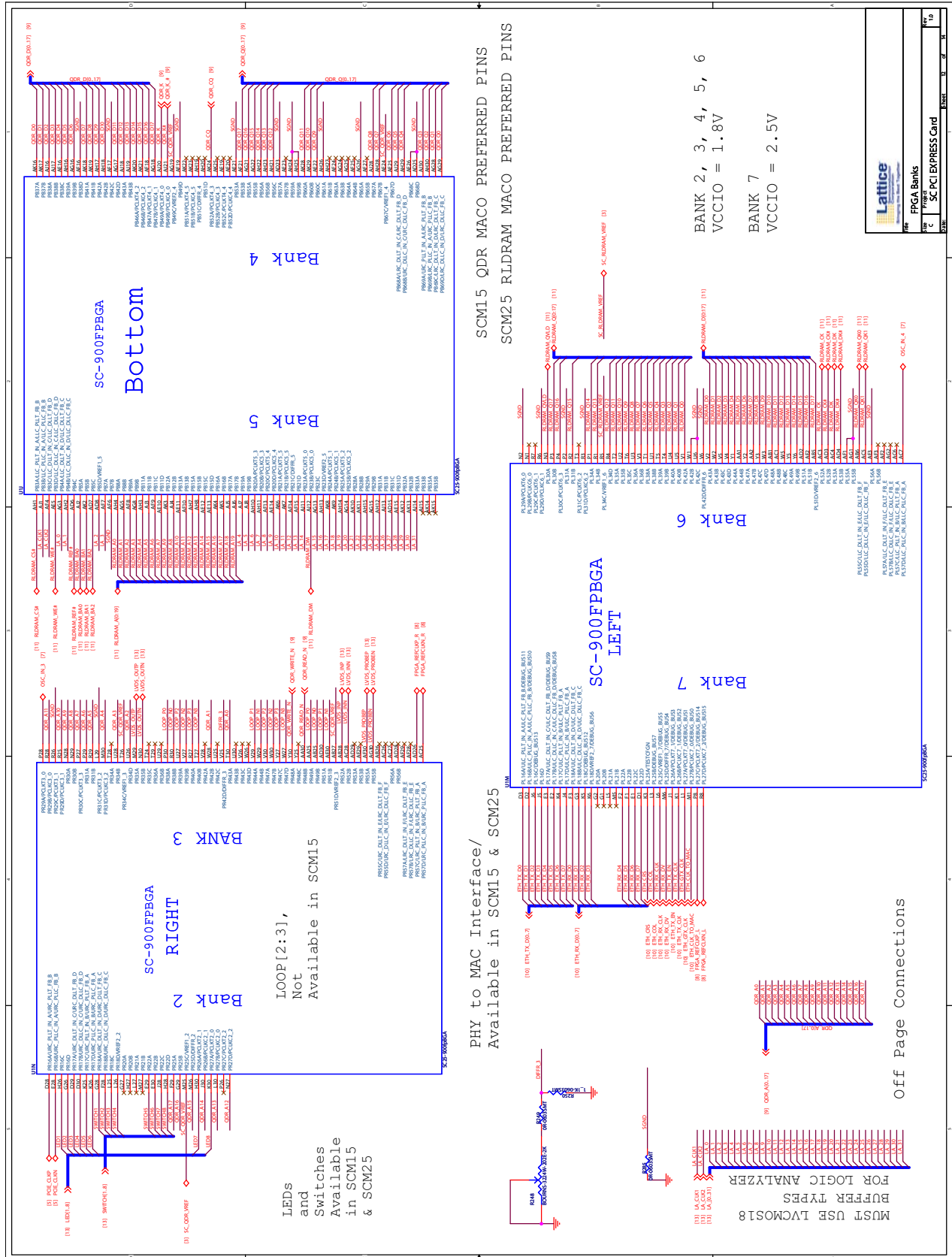

Figure 16. PC RS232 Test

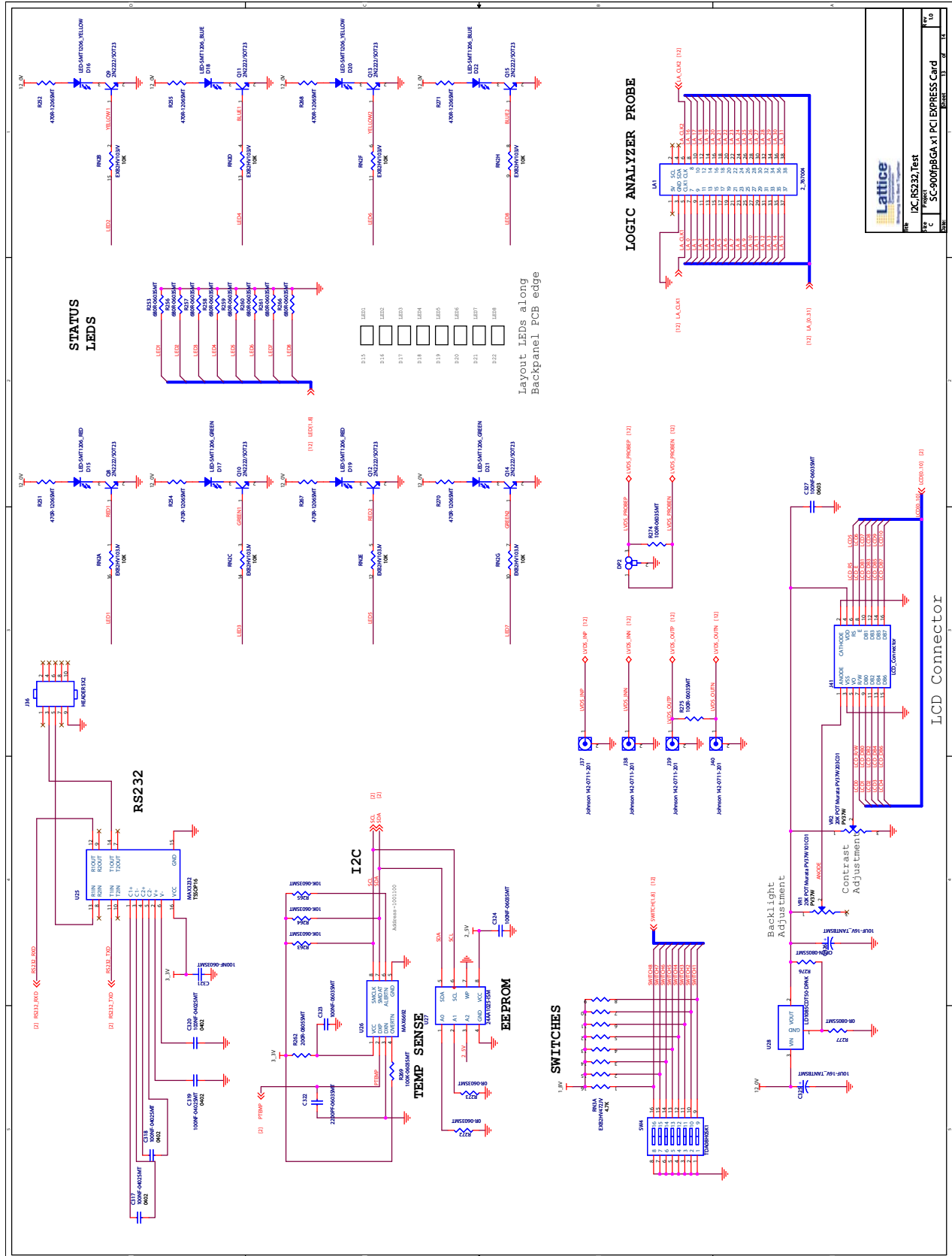
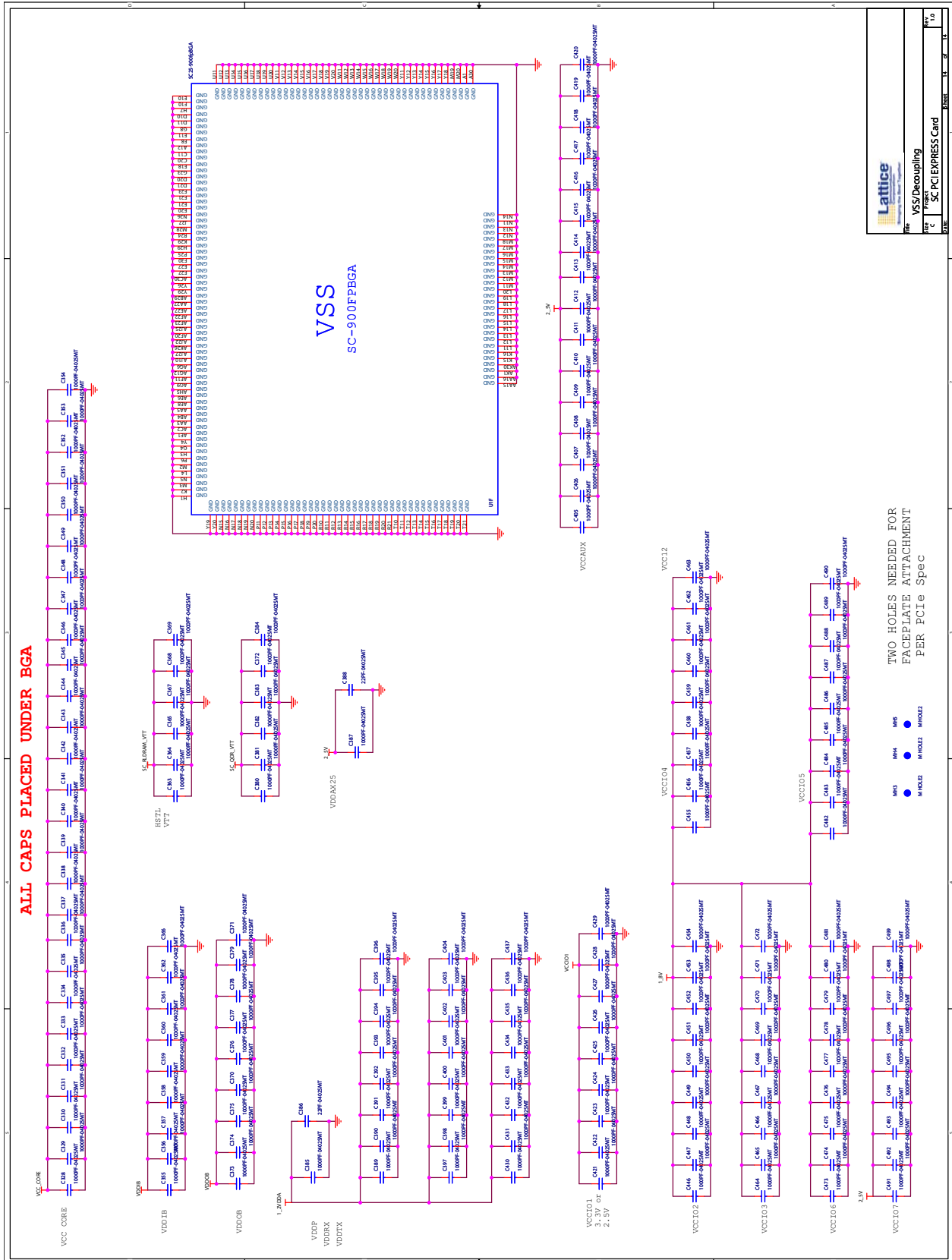

Figure 17. VSS Decoupling



## X-ON Electronics

Largest Supplier of Electrical and Electronic Components

*Click to view similar products for [Programmable Logic IC Development Tools](#) category:*

*Click to view products by [Lattice](#) manufacturer:*

Other Similar products are found below :

[HLDC-DDR3-A](#) [DK-DEV-5SGXEA7N](#) [EK-10M50F484](#) [EPXA4F672C2](#) [EPXA4F672C3](#) [EPXA4F672C1](#) [K0161](#) [LCMXO256C-S-EVN](#)  
[12GSDIFMCCD](#) [SFP+X4FMCCD](#) [88980182](#) [P0582](#) [HW-PWAC-2600317](#) [DEV-17514](#) [LCMXO3D-9400HC-B-EVN](#) [P0671](#) [DK-K7-](#)  
[CONN-G](#) [P0467](#) [LCMXO2-1200ZE-P1-EVN](#) [LCMXO2-4000HE-DSIB-EVN](#) [DK-DEV-4SGX530N](#) [LCMXO3L-SMA-EVN](#) [P006-006-2](#)  
[EK-U1-VCU108-G](#) [A2F500-DEV-KIT-2](#) [LCMXO3LF-9400C-ASC-B-EVN](#) [471-014](#) [EVAL-TPG-ZYNQ3](#) [SL001](#) [80-001005](#) [P0466-EDU](#)  
[EK-10CL025U256](#) [P0496](#) [P0493](#) [DK-SOC-10AS066S-A](#) [DK-DEV-10CX220-A](#) [80-001002](#) [iCE40UP5K-MDP-EVN](#) [RXCA10S066PF34-](#)  
[IDK00A](#) [ALTHYDRAC5GX](#) [ALTNITROC5GX](#) [ALTBERYLLC5GX](#) [471-015](#) [LFE3-17EA-USB3-EVN](#) [1553](#) [4332](#) [Hinj](#) [HinjKit](#)  
[SNOMAKRRKIT](#) [SnoMakrR10](#)