

GT Series 150, 280 & Lever Lock



The GT Connection System™ features tangless terminals and offers one of the lowest connector engage forces in the industry. Designed for both 1.50 and 2.80mm blade width applications, GT achieves superior electrical performance that meets or exceeds all known customer requirements, including USCAR standards. The unsealed systems are available in cavity variations between 2-way and 16-way. To maintain world class ergonomics, Delphi Packard introduced the GT Lever Lock series. This series provides connector mating forces of less than 50 Newtons for up to 40 terminations per connector.



The sealed GT Connection System™ utilizes a new two-rib cable seal. This seal is smaller and uses less material than traditional three rib seal designs without impacting performance. The sealed systems are available in cavity variations between 2-way and 16-way. To maintain world class ergonomics, Delphi Packard introduced the sealed GT Lever Lock series. This series provides connector mating forces of less than 50 Newtons for up to 40 terminations per connector.

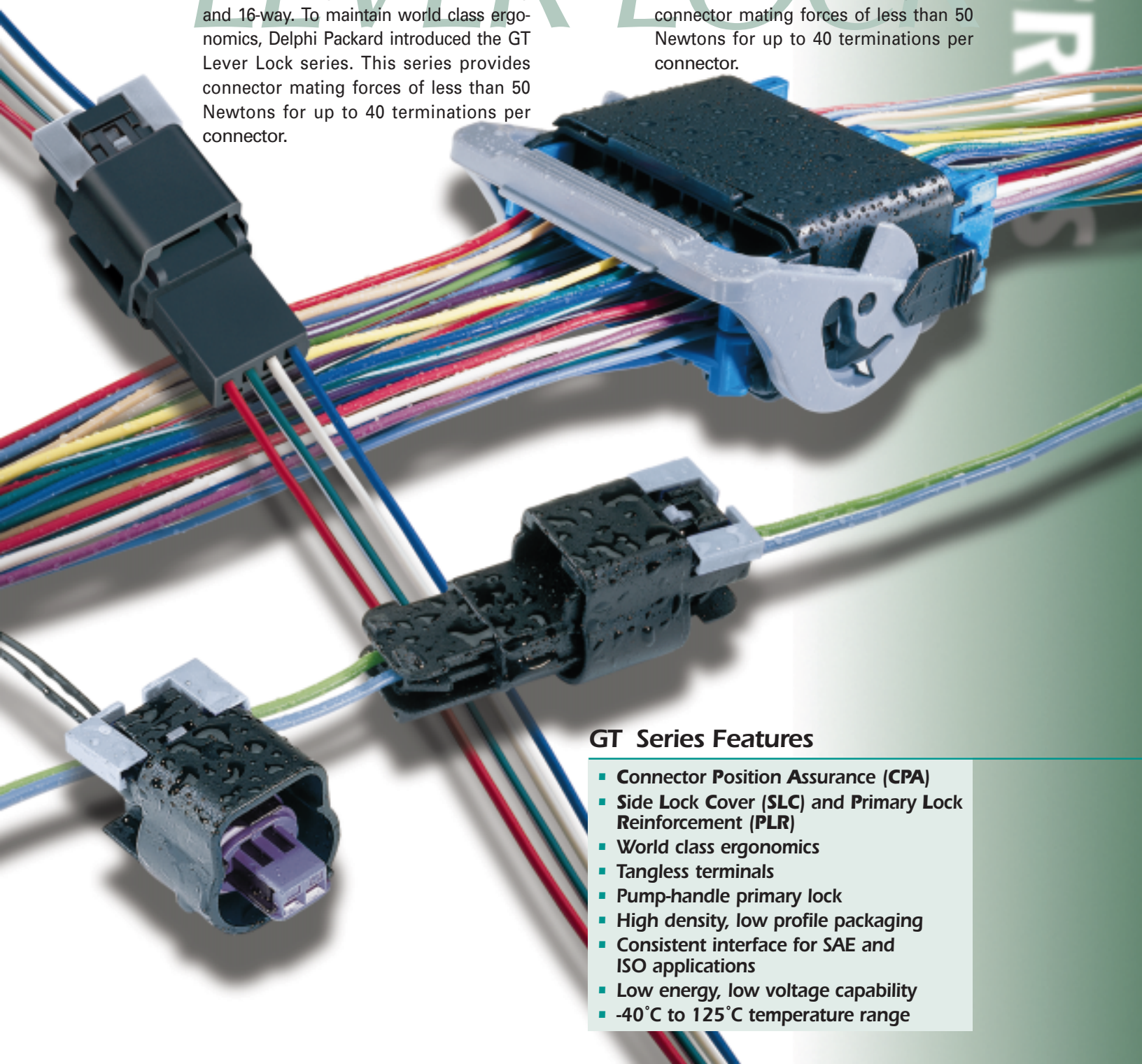

GT Series Features

- Connector Position Assurance (CPA)
- Side Lock Cover (SLC) and Primary Lock Reinforcement (PLR)
- World class ergonomics
- Tangless terminals
- Pump-handle primary lock
- High density, low profile packaging
- Consistent interface for SAE and ISO applications
- Low energy, low voltage capability
- -40°C to 125°C temperature range



Cross Sectional View

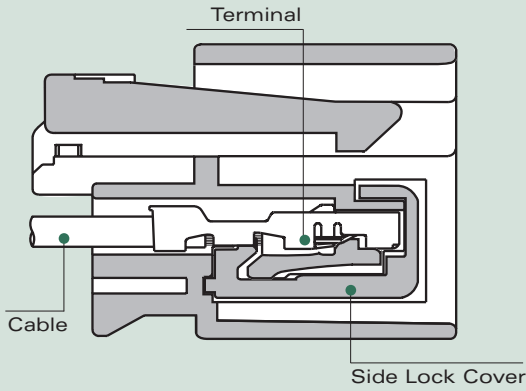

Female Connector Assembly

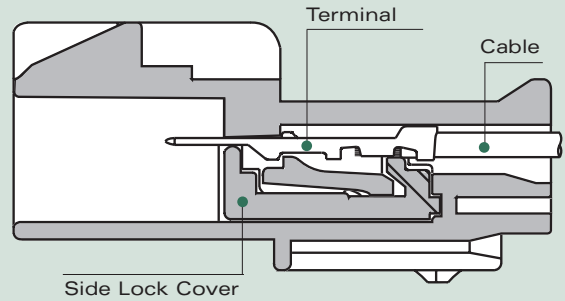

Male Connector Assembly

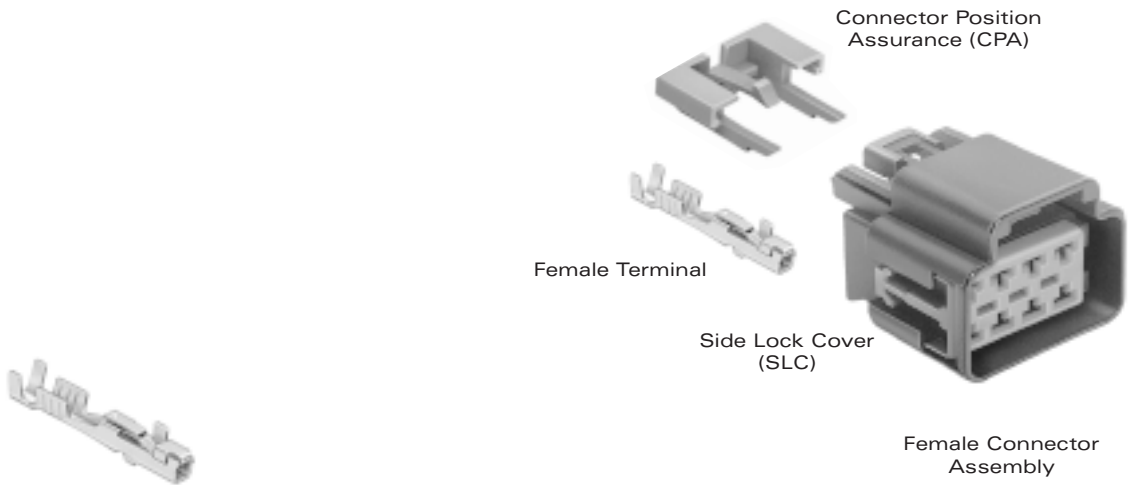

GT 150 FEMALE TERMINALS UNSEALED

Part #	Cable Range (mm ²)	Material	Plating
12191811	0.50-0.35	Tin Brass	Tin
12191812	1.00-0.75	Tin Brass	Tin

GT 150 FEMALE CONNECTOR ASSEMBLIES UNSEALED

# Cavities	Connector	Color	Material
2	15332129	Black	PA6 10% GF & 20% GB
3	15332132	Black	PA6 10% GF & 20% GB
4	15332135	Black	PA6 10% GF & 20% GB
5	15332138	Black	PA6 10% GF & 20% GB
6	15332141	Black	PA6 10% GF & 20% GB
8	15332145	Black	PA6 10% GF & 20% GB
10	15332153	Black	PA6 10% GF & 20% GB
12	15332161	Black	PA6 10% GF & 20% GB
14	15332169	Black	PA6 10% GF & 20% GB
16	15332177	Black	PA6 10% GF & 20% GB

Side Lock Covers (SLC) are included in the Connector Assemblies listed in this section.

<http://delphi.com/products/connect>



Unsealed System Application Information

CABLE RANGE (mm²): 0.35-1.0
CURRENT RANGE (AMPS): 0-15
TEMP RANGE °C: -40 to 125
RESISTANCE: <10mΩ@20mV
VOLTAGE DROP: <10.0mV/amp
CENTERLINE SPACING (mm): 4.0
BLADE WIDTH (mm): 1.5

GT 150 SERIES TERMINALS-Tin Plated

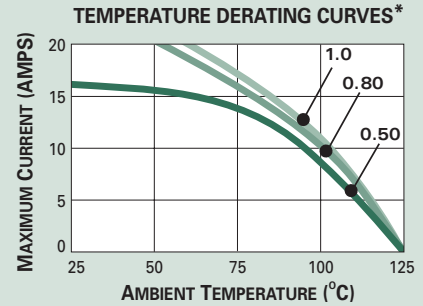
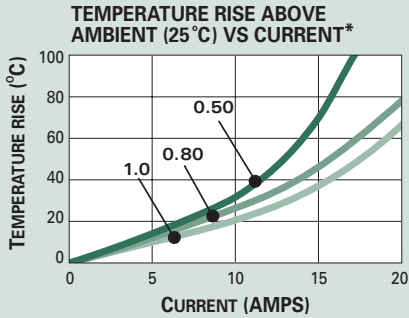

*The test data are based on single circuits in free space and were generated using a "Lumped Resistance" model. This model does not account for all of the variables that would be present in an actual application. For actual product performance, contact your regional support representative at the number listed below.

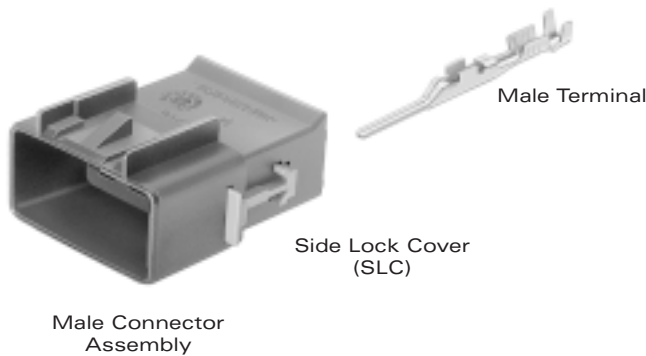

GT 150 MALE CONNECTOR ASSEMBLIES UNSEALED

# Cavities	Connector	Color	Material
2	15332130	Black	PA6 10% GF & 20% GB
3	15332133	Black	PA6 10% GF & 20% GB
4	15332136	Black	PA6 10% GF & 20% GB
5	15332139	Black	PA6 10% GF & 20% GB
6	15332142	Black	PA6 10% GF & 20% GB
8	15332150	Black	PA6 10% GF & 20% GB
10	15332158	Black	PA6 10% GF & 20% GB
12	15332166	Black	PA6 10% GF & 20% GB
14	15332174	Black	PA6 10% GF & 20% GB
16	15332182	Black	PA6 10% GF & 20% GB

Side Lock Covers (SLC) are included in the Connector Assemblies listed in this section.

GT 150 MALE TERMINALS UNSEALED

Part #	Cable Range (mm ²)	Material	Plating
15304701	0.50-0.35	Tin Brass	Tin
15304702	1.00-0.75	Tin Brass	Tin

SECTION NOTES:

- Contact your regional support representative at the number listed below.
- Due to rigid tolerances of connector cavities, it is critical to meet all crimp dimensions as specified.

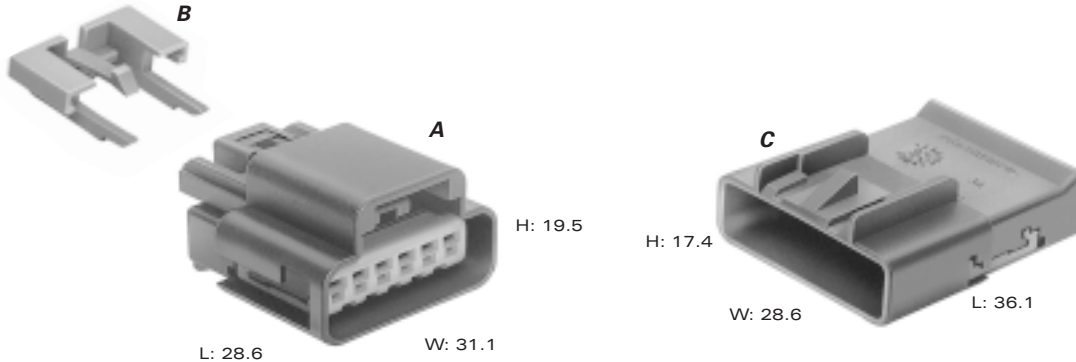

Total Mated Length: 52.1mm

A PART NO: 15332129
 DESCRIPTION: Connector Assembly 2F
 SIZE: 28.6L x 19.5H x 15.1W
 COLOR: Black
 MATERIAL: PA6 10% GF & 20% GB
 TERMINALS: See Page 10

C PART NO: 15332130
 DESCRIPTION: Connector Assembly 2M
 SIZE: 36.1L x 17.4H x 12.6W
 COLOR: Black
 MATERIAL: PA6 10% GF & 20% GB
 TERMINALS: See Page 11

PART NO: 15332132
 DESCRIPTION: Connector Assembly 3F
 SIZE: 28.6L x 19.5H x 19.1W
 COLOR: Black
 MATERIAL: PA6 10% GF & 20% GB
 TERMINALS: See Page 10

PART NO: 15332133
 DESCRIPTION: Connector Assembly 3M
 SIZE: 36.1L x 17.4H x 16.6W
 COLOR: Black
 MATERIAL: PA6 10% GF & 20% GB
 TERMINALS: See Page 11

PART NO: 15332135
 DESCRIPTION: Connector Assembly 4F
 SIZE: 28.6L x 19.5H x 23.1W
 COLOR: Black
 MATERIAL: PA6 10% GF & 20% GB
 TERMINALS: See Page 10

PART NO: 15332136
 DESCRIPTION: Connector Assembly 4M
 SIZE: 36.1L x 17.4H x 20.6W
 COLOR: Black
 MATERIAL: PA6 10% GF & 20% GB
 TERMINALS: See Page 11

PART NO: 15332138
 DESCRIPTION: Connector Assembly 5F
 SIZE: 28.6L x 19.5H x 27.1W
 COLOR: Black
 MATERIAL: PA6 10% GF & 20% GB
 TERMINALS: See Page 10

PART NO: 15332139
 DESCRIPTION: Connector Assembly 5M
 SIZE: 36.1L x 17.4H x 24.6W
 COLOR: Black
 MATERIAL: PA6 10% GF & 20% GB
 TERMINALS: See Page 11

PART NO: 15332141
 DESCRIPTION: Connector Assembly 6F
 SIZE: 28.6L x 19.5H x 31.1W
 COLOR: Black
 MATERIAL: PA6 10% GF & 20% GB
 TERMINALS: See Page 10

PART NO: 15332142
 DESCRIPTION: Connector Assembly 6M
 SIZE: 36.1L x 17.4H x 28.6W
 COLOR: Black
 MATERIAL: PA6 10% GF & 20% GB
 TERMINALS: See Page 11

B PART NO: 15317832
 DESCRIPTION: CPA
 COLOR: Gray
 MATERIAL: PA6 10% GF & 20% GB

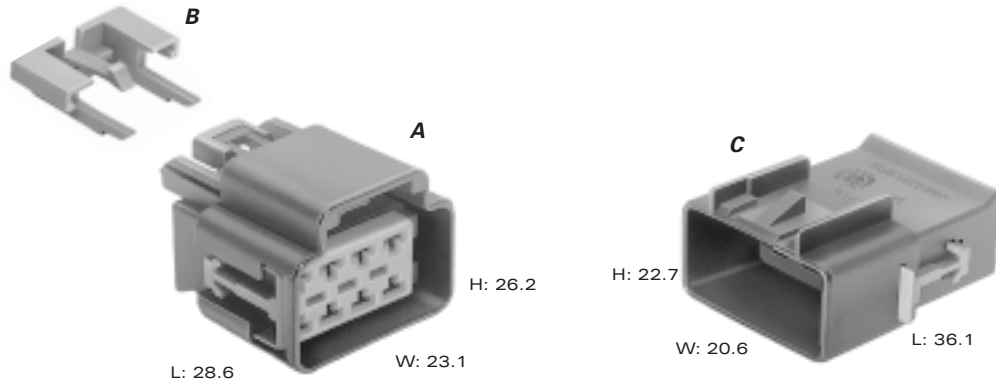

Total Mated Length: 52.1mm

A PART NO: 15332145
 DESCRIPTION: Connector Assembly 8F
 SIZE: 28.6L x 26.2H x 23.1W
 COLOR: Black
 MATERIAL: PA6 10% GF & 20% GB
 TERMINALS: See Page 10

PART NO: 15332153
 DESCRIPTION: Connector Assembly 10F
 SIZE: 28.6L x 26.2H x 27.1W
 COLOR: Black
 MATERIAL: PA6 10% GF & 20% GB
 TERMINALS: See Page 10

PART NO: 15332161
 DESCRIPTION: Connector Assembly 12F
 SIZE: 28.6L x 26.2H x 31.1W
 COLOR: Black
 MATERIAL: PA6 10% GF & 20% GB
 TERMINALS: See Page 10

PART NO: 15332169
 DESCRIPTION: Connector Assembly 14F
 SIZE: 28.6L x 26.2H x 35.1W
 COLOR: Black
 MATERIAL: PA6 10% GF & 20% GB
 TERMINALS: See Page 10

PART NO: 15332177
 DESCRIPTION: Connector Assembly 16F
 SIZE: 28.6L x 26.2H x 39.1W
 COLOR: Black
 MATERIAL: PA6 10% GF & 20% GB
 TERMINALS: See Page 10

B PART NO: 15317832
 DESCRIPTION: CPA
 COLOR: Gray
 MATERIAL: PA6 10% GF & 20% GB

C PART NO: 15332150
 DESCRIPTION: Connector Assembly 8M
 SIZE: 36.1L x 22.7H x 20.6W
 COLOR: Black
 MATERIAL: PA6 10% GF & 20% GB
 TERMINALS: See Page 11

PART NO: 15332158
 DESCRIPTION: Connector Assembly 10M
 SIZE: 36.1L x 22.7H x 24.6W
 COLOR: Black
 MATERIAL: PA6 10% GF & 20% GB
 TERMINALS: See Page 11

PART NO: 15332166
 DESCRIPTION: Connector Assembly 12M
 SIZE: 36.1L x 22.7H x 28.6W
 COLOR: Black
 MATERIAL: PA6 10% GF & 20% GB
 TERMINALS: See Page 11

PART NO: 15332174
 DESCRIPTION: Connector Assembly 14M
 SIZE: 36.1L x 22.7H x 32.6W
 COLOR: Black
 MATERIAL: PA6 10% GF & 20% GB
 TERMINALS: See Page 11

PART NO: 15332182
 DESCRIPTION: Connector Assembly 16M
 SIZE: 36.1L x 22.7H x 36.6W
 COLOR: Black
 MATERIAL: PA6 10% GF & 20% GB
 TERMINALS: See Page 11



Cross Sectional View

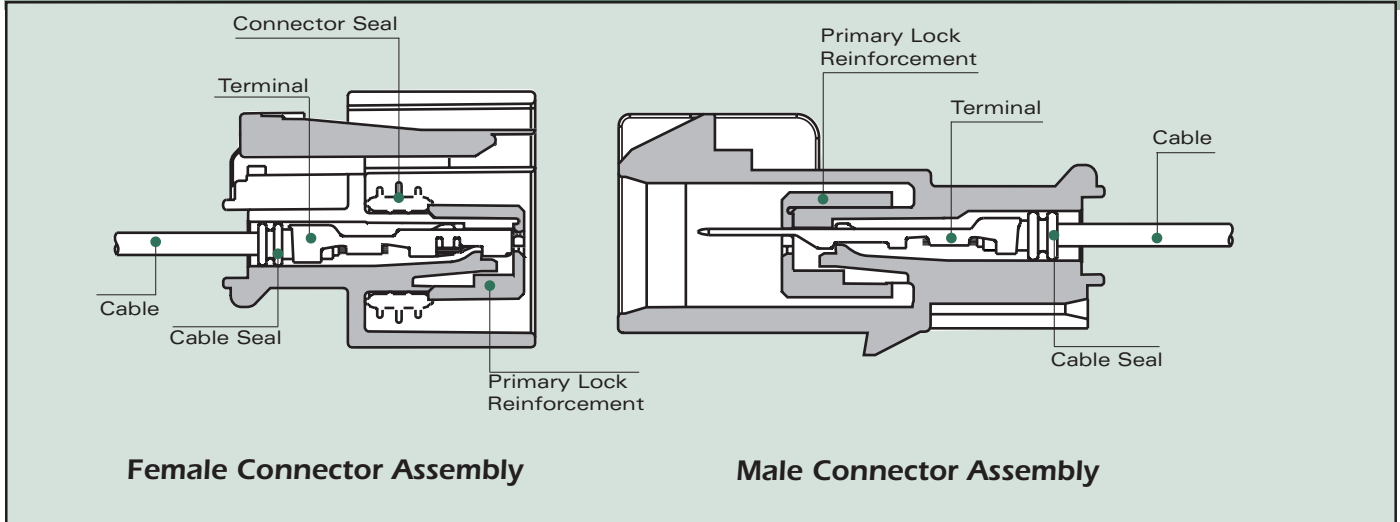

Connector Position Assurance (CPA)

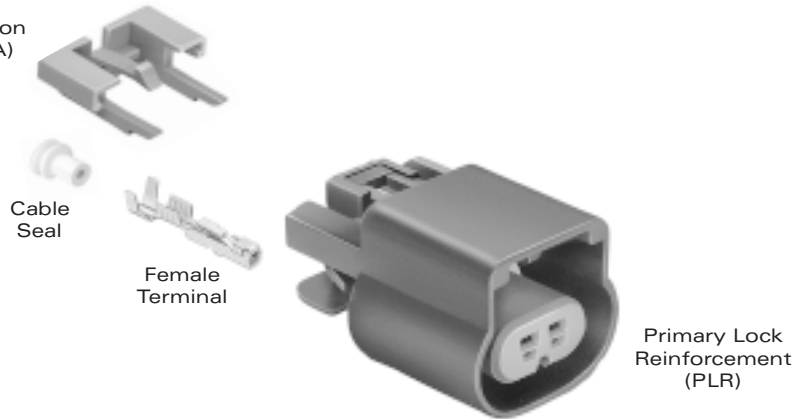

Female Connector Assembly

GT 150 FEMALE TERMINALS SEALED

Part #	Cable Range (mm ²)	Material	Plating
12191818	0.50-0.35	Tin Brass	Tin
12191819	1.00-0.75	Tin Brass	Tin



GT 150 CABLE SEALS

Reel Part #	Loose Part #	Cable Diameter	Material	Color
12191152	15366021	1.20-1.85	Silicone	White
12191153	15366060	1.86-2.25	Silicone	Blue

GT 150 FEMALE CONNECTOR ASSEMBLIES SEALED

# Cavities	Connector	Color	Material
2	15326801	Black	PA6 10% GF & 20% GB
3	15326808	Black	PA6 10% GF & 20% GB
4	15326815	Black	PA6 10% GF & 20% GB
5	15326822	Black	PA6 10% GF & 20% GB
6	15326829	Black	PA6 10% GF & 20% GB
8	15326835	Black	PA6 10% GF & 20% GB
10	15326842	Black	PA6 10% GF & 20% GB
12	15326849	Black	PA6 10% GF & 20% GB
14	15326856	Black	PA6 10% GF & 20% GB
16	15326863	Black	PA6 10% GF & 20% GB

Primary Lock Reinforcement (PLR) and Connector Seals are included in the Connector Assemblies listed in this section.

<http://delphi.com/products/connect>



Sealed System Application Information

CABLE RANGE (mm²): 0.35-1.0
CURRENT RANGE (AMPS): 0-15
TEMP RANGE °C: -40 to 125
RESISTANCE: <10mΩ@20mV
VOLTAGE DROP: <10.0mV/amp
CENTERLINE SPACING (mm):..... 4.5
BLADE WIDTH (mm):..... 1.5

GT 150 SERIES TERMINALS-Tin Plated

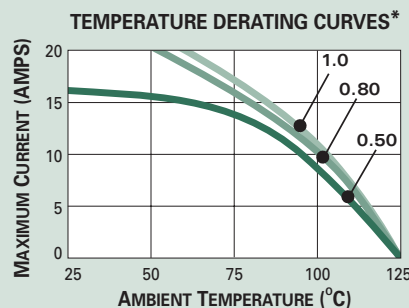
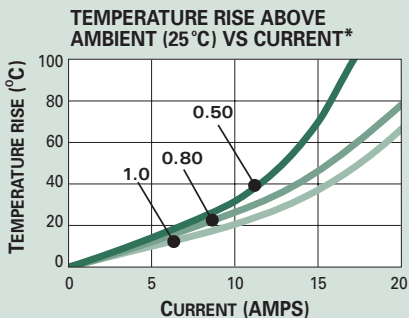

*The test data are based on single circuits in free space and were generated using a "Lumped Resistance" model. This model does not account for all of the variables that would be present in an actual application. For actual product performance, contact your regional support representative at the number listed below.

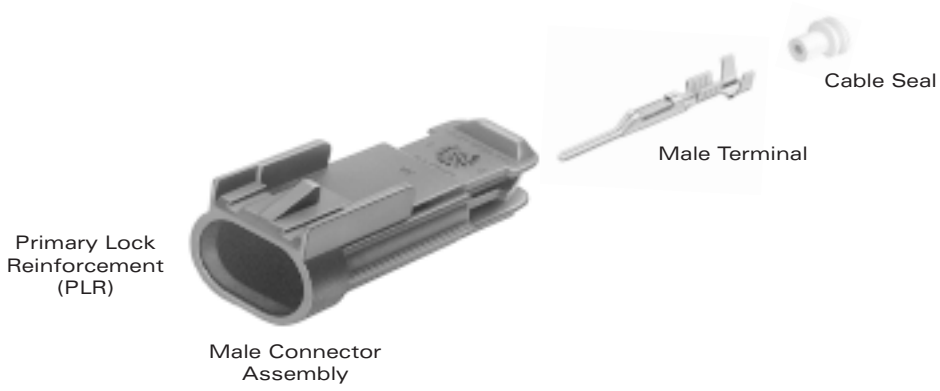

GT 150 MALE CONNECTOR ASSEMBLIES SEALED			
# Cavities	Connector	Color	Material
2	15326806	Black	PA6 10% GF & 20% GB
3	15326813	Black	PA6 10% GF & 20% GB
4	15326820	Black	PA6 10% GF & 20% GB
5	15326827	Black	PA6 10% GF & 20% GB
6	15326833	Black	PA6 10% GF & 20% GB
8	15326840	Black	PA6 10% GF & 20% GB
10	15326847	Black	PA6 10% GF & 20% GB
12	15326854	Black	PA6 10% GF & 20% GB
14	15326861	Black	PA6 10% GF & 20% GB
16	15326868	Black	PA6 10% GF & 20% GB

Primary Lock Reinforcement (PLR) is included in the Connector Assemblies listed in this section.

GT 150 MALE TERMINALS SEALED			
Part #	Cable Range (mm ²)	Material	Plating
15326268	0.50-0.35	Tin Brass	Tin
15326269	1.00-0.75	Tin Brass	Tin

GT 150 CAVITY PLUG*			
Part #	Cavity Diameter	Material	Color
15305171	4.0mm	Silicone	Green

*Cavity plugs seal unused female and male cavities.

SECTION NOTES:

Contact your regional support representative at the number listed below.

- Due to rigid tolerances of connector cavities, it is critical to meet all crimp dimensions as specified.

<http://delphi.com/products/connect>

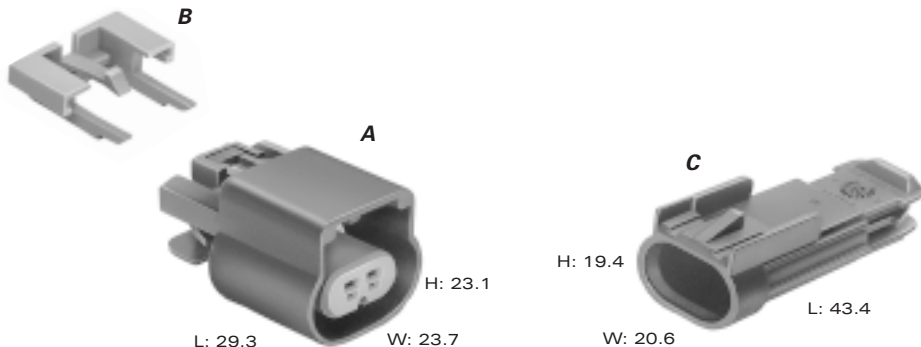

Total Mated Length: 56.7mm

A PART NO: 15326801
 DESCRIPTION: Connector Assembly 2F
 SIZE: 29.3L x 23.1H x 23.7W
 COLOR: Black
 MATERIAL: PA6 10% GF & 20% GB
 TERMINALS: See Page 14
 SEALS/PLUGS: See Page 14, 15

C PART NO: 15326806
 DESCRIPTION: Connector Assembly 2M
 SIZE: 43.4L x 19.4H x 20.6W
 COLOR: Black
 MATERIAL: PA6 10% GF & 20% GB
 TERMINALS: See Page 15
 SEALS/PLUGS: See Page 14, 15

PART NO: 15326808
 DESCRIPTION: Connector Assembly 3F
 SIZE: 29.3L x 23.1H x 28.2W
 COLOR: Black
 MATERIAL: PA6 10% GF & 20% GB
 TERMINALS: See Page 14
 SEALS/PLUGS: See Page 14, 15

PART NO: 15326813
 DESCRIPTION: Connector Assembly 3M
 SIZE: 43.4L x 19.4H x 25.1W
 COLOR: Black
 MATERIAL: PA6 10% GF & 20% GB
 TERMINALS: See Page 15
 SEALS/PLUGS: See Page 14, 15

PART NO: 15326815
 DESCRIPTION: Connector Assembly 4F
 SIZE: 29.3L x 23.1H x 32.7W
 COLOR: Black
 MATERIAL: PA6 10% GF & 20% GB
 TERMINALS: See Page 14
 SEALS/PLUGS: See Page 14, 15

PART NO: 15326820
 DESCRIPTION: Connector Assembly 4M
 SIZE: 43.4L x 19.4H x 29.6W
 COLOR: Black
 MATERIAL: PA6 10% GF & 20% GB
 TERMINALS: See Page 15
 SEALS/PLUGS: See Page 14, 15

PART NO: 15326822
 DESCRIPTION: Connector Assembly 5F
 SIZE: 29.3L x 23.1H x 37.2W
 COLOR: Black
 MATERIAL: PA6 10% GF & 20% GB
 TERMINALS: See Page 14
 SEALS/PLUGS: See Page 14, 15

PART NO: 15326827
 DESCRIPTION: Connector Assembly 5M
 SIZE: 43.4L x 19.4H x 34.1W
 COLOR: Black
 MATERIAL: PA6 10% GF & 20% GB
 TERMINALS: See Page 15
 SEALS/PLUGS: See Page 14, 15

PART NO: 15326829
 DESCRIPTION: Connector Assembly 6F
 SIZE: 29.3L x 23.1H x 41.7W
 COLOR: Black
 MATERIAL: PA6 10% GF & 20% GB
 TERMINALS: See Page 14
 SEALS/PLUGS: See Page 14, 15

PART NO: 15326833
 DESCRIPTION: Connector Assembly 6M
 SIZE: 43.4L x 19.4H x 38.6W
 COLOR: Black
 MATERIAL: PA6 10% GF & 20% GB
 TERMINALS: See Page 15
 SEALS/PLUGS: See Page 14, 15

B PART NO: 15317832
 DESCRIPTION: CPA
 COLOR: Gray
 MATERIAL: PA6 10% GF & 20% GB

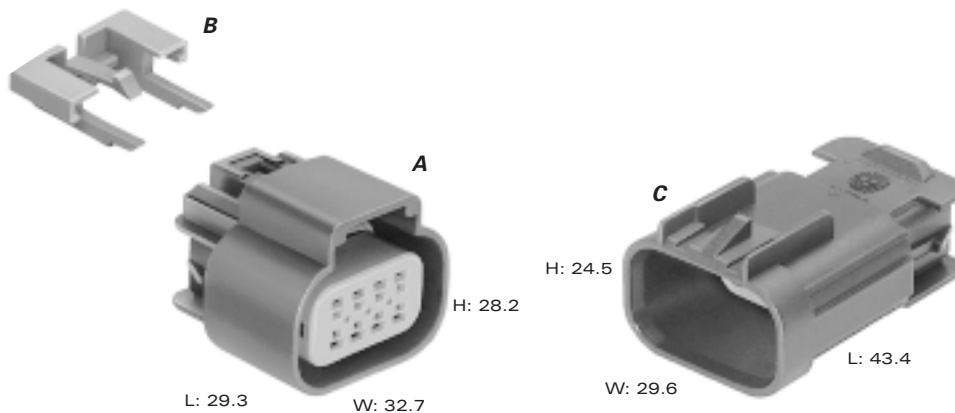

Total Mated Length: 56.7mm

A PART NO: 15326835
 DESCRIPTION: Connector Assembly 8F
 SIZE: 29.3L x 28.2H x 32.7W
 COLOR: Black
 MATERIAL: PA6 10% GF & 20% GB
 TERMINALS: See Page 14
 SEALS/PLUGS: See Page 14, 15

PART NO: 15326842
 DESCRIPTION: Connector Assembly 10F
 SIZE: 29.3L x 28.2H x 37.2W
 COLOR: Black
 MATERIAL: PA6 10% GF & 20% GB
 TERMINALS: See Page 14
 SEALS/PLUGS: See Page 14, 15

PART NO: 15326849
 DESCRIPTION: Connector Assembly 12F
 SIZE: 29.3L x 28.2H x 41.7W
 COLOR: Black
 MATERIAL: PA6 10% GF & 20% GB
 TERMINALS: See Page 14
 SEALS/PLUGS: See Page 14, 15

PART NO: 15326856
 DESCRIPTION: Connector Assembly 14F
 SIZE: 29.3L x 28.2H x 46.2W
 COLOR: Black
 MATERIAL: PA6 10% GF & 20% GB
 TERMINALS: See Page 14
 SEALS/PLUGS: See Page 14, 15

PART NO: 15326863
 DESCRIPTION: Connector Assembly 16F
 SIZE: 29.3L x 28.2H x 50.7W
 COLOR: Black
 MATERIAL: PA6 10% GF & 20% GB
 TERMINALS: See Page 14
 SEALS/PLUGS: See Page 14, 15

B PART NO: 15317832
 DESCRIPTION: CPA
 COLOR: Gray
 MATERIAL: PA6 10% GF & 20% GB

C PART NO: 15326840
 DESCRIPTION: Connector Assembly 8M
 SIZE: 43.4L x 24.5H x 29.6W
 COLOR: Black
 MATERIAL: PA6 10% GF & 20% GB
 TERMINALS: See Page 15
 SEALS/PLUGS: See Page 14, 15

PART NO: 15326847
 DESCRIPTION: Connector Assembly 10M
 SIZE: 43.4L x 24.5H x 34.1W
 COLOR: Black
 MATERIAL: PA6 10% GF & 20% GB
 TERMINALS: See Page 15
 SEALS/PLUGS: See Page 14, 15

PART NO: 15326854
 DESCRIPTION: Connector Assembly 12M
 SIZE: 43.4L x 24.5H x 38.6W
 COLOR: Black
 MATERIAL: PA6 10% GF & 20% GB
 TERMINALS: See Page 15
 SEALS/PLUGS: See Page 14, 15

PART NO: 15326861
 DESCRIPTION: Connector Assembly 14M
 SIZE: 43.4L x 24.5H x 43.1W
 COLOR: Black
 MATERIAL: PA6 10% GF & 20% GB
 TERMINALS: See Page 15
 SEALS/PLUGS: See Page 14, 15

PART NO: 15326868
 DESCRIPTION: Connector Assembly 16M
 SIZE: 43.4L x 24.5H x 47.6W
 COLOR: Black
 MATERIAL: PA6 10% GF & 20% GB
 TERMINALS: See Page 15
 SEALS/PLUGS: See Page 14, 15



Sealed System Application Information

CABLE RANGE (mm²): 0.35-1.0
 CURRENT RANGE (AMPS): 0-15
 TEMP RANGE °C: -40 to 125
 RESISTANCE: <10mΩ@20mV
 VOLTAGE DROP: <10.0mV/amp
 CENTERLINE SPACING (mm): 3.5
 BLADE WIDTH (mm): 1.5

GT 150 SERIES TERMINALS-Tin Plated

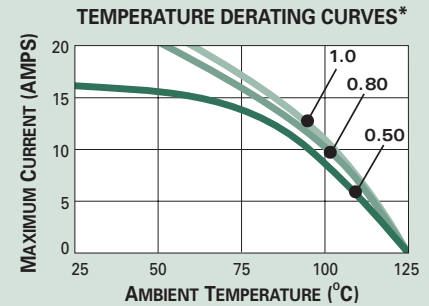
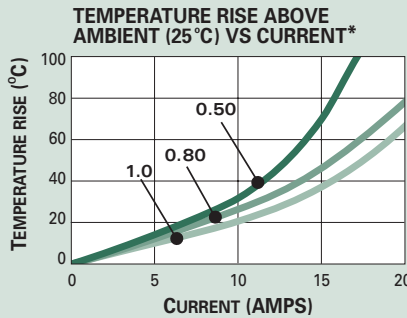

*The test data are based on single circuits in free space and were generated using a "Lumped Resistance" model. This model does not account for all of the variables that would be present in an actual application. For actual product performance, contact your regional support representative at the number listed below.



Cable Seal



Female Terminal

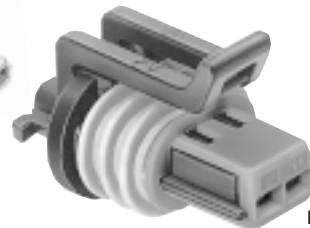

Unshrouded Female Connector Assembly

Mushroom Indexed Primary Lock Reinforcement (PLR)



GT 150 FEMALE TERMINALS SEALED

Part #	Cable Range (mm ²)	Material	Plating
15326266	0.50-0.35	Tin Brass	Tin
15305350	1.00*-0.75	Tin Brass	Tin

*Accommodates 1.00 European Ultra Thin Wall Cable.
 Accomdates 0.80 SAE Ultra Thin Wall Cable

GT 150 FEMALE UNSHROUDED CONNECTOR ASSEMBLIES SEALED

# Cavities	Conn. Asm.	Indexing	Color	Material
2	15336024	Mushroom	Black	PA6 10% GF & 20% GB
2 TBI	15336027	Mushroom	Black	PA6 10% GF & 20% GB
3	15336029	Mushroom	Black	PA6 10% GF & 20% GB
4	15354716	Mushroom	Black	PA6 10% GF & 20% GB

GT 150 CABLE SEALS

Reel Part #	Loose Part #	Cable Diameter	Material	Color
12191155	15366022	1.47-1.85	Silicone	Green
—	15305351	1.70-2.10	Silicone	Yellow

GT 150 CAVITY PLUG*

Part #	Material	Color
15305169	Silicone	Orange

*Cavity plugs seal unused female and male cavities.

<http://delphi.com/products/connect>

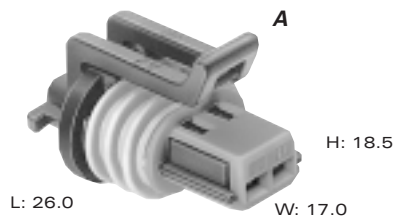
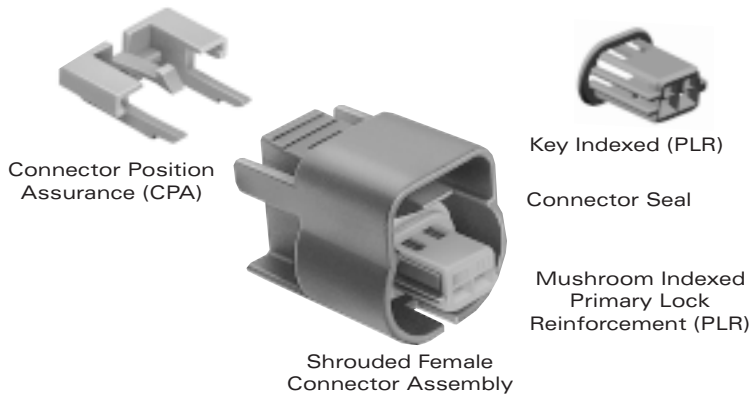

Unshrouded Female Mushroom Indexed

A PART NO: 15336024
 DESCRIPTION: Connector Assembly 2F
 SIZE: 26.0L x 18.5H x 17.0W
 COLOR: Black
 MATERIAL: PA6 10% GF & 20% GB
 TERMINALS: See Page 18
 SEALS/PLUGS: See Page 18

PART NO: 15336027
 DESCRIPTION: TBI Connector Assembly 2F
 SIZE: 26.0L x 11.0H x 20.5W
 COLOR: Black
 MATERIAL: PA6 10% GF & 20% GB
 TERMINALS: See Page 18
 SEALS/PLUGS: See Page 18
 NOTE: Mates to Throttle Body Injector.

PART NO: 15336029
 DESCRIPTION: Connector Assembly 3F
 SIZE: 26.0L x 18.5H x 20.5W
 COLOR: Black
 MATERIAL: PA6 10% GF & 20% GB
 TERMINALS: See Page 18
 SEALS/PLUGS: See Page 18

PART NO: 15354716
 DESCRIPTION: Connector Assembly 4F
 SIZE: 26.0L x 18.5H x 24.0W
 COLOR: Black
 MATERIAL: PA6 10% GF & 20% GB
 TERMINALS: See Page 18
 SEALS/PLUGS: See Page 18

GT 150 FEMALE SHROUDED CONNECTOR ASSEMBLIES SEALED

# Cavities	Conn. Asm.	Indexing	Color	Material
2	15336004	Mushroom	Black	PA6 10% GF & 20% GB
2	15355317	Mushroom	Black	PBT 20% GF
3	15336121	Mushroom	Black	PA66 HS IM
3	15355323	Mushroom	Black	PBT 20% GF
4	15355331	Mushroom	Black	PA66 HS IM
4	15355331	Mushroom	Black	PBT 20% GF
5	15326389	Mushroom	Black	PA66 HS IM
5	15355268	Mushroom	Black	PBT 20% GF
6	15336013	Mushroom	Black	PBT 20% GF
<hr/>				
2	15335987	Key	Black	PA6 10% GF & 20% GB
2	15355319	Key	Black	PBT 20% GF
3	15326556	Key	Black	PA66 HS IM
3	15355325	Key	Black	PBT 20% GF
4	15336001	Key	Black	PA66 HS IM
4	15355329	Key	Black	PBT 20% GF

GT CONNECTOR ASSEMBLY/METRI-PACK PULL-TO-SEAT REPLACEMENT CROSS REFERENCE

GT Connector Assembly	Description	Metri-Pack Pull-To-Seat
15336024	Connector Assembly 2F	12162193, 12162194, 12162195
15336027 TBI	Connector Assembly 2F	12162204, 12162206, 12162208, 12162215, 12162216, 12162217, 12162218
15336029	Connector Assembly 3F	12162182, 12162183, 12162184, 12162185, 12162186
15336035	Connector Assembly 4F	12124846, 12129192, 12162188, 12162189, 12162190, 12162191

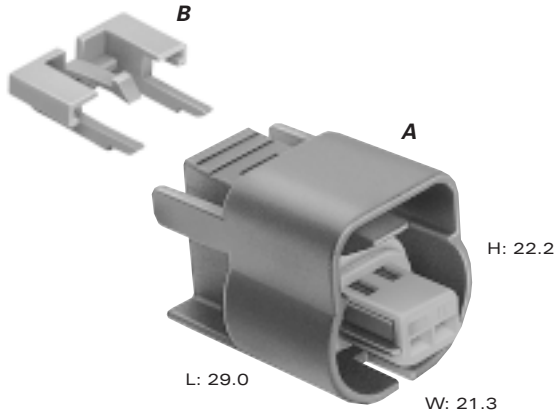

**Shrouded Female
Mushroom Indexed**

A PART NO: 15336004*
DESCRIPTION: Connector Assembly 2F
SIZE: 29.0L x 22.2H x 21.3W
COLOR: Black
MATERIAL: PA6 10% GF & 20% GB
TERMINALS: See Page 18
SEALS/PLUGS: See Page 18
*See Page 19 for alternative material

PART NO: 15326389*
DESCRIPTION: Connector Assembly 5F
SIZE: 29.0L x 22.2H x 31.8W
COLOR: Black
MATERIAL: PA66 HS IM
TERMINALS: See Page 18
SEALS/PLUGS: See Page 18
*See Page 19 for alternative material

PART NO: 15336121*
DESCRIPTION: Connector Assembly 3F
SIZE: 29.0L x 22.2H x 24.8W
COLOR: Black
MATERIAL: PA66 HS IM
TERMINALS: See Page 18
SEALS/PLUGS: See Page 18
*See Page 19 for alternative material

PART NO: 15336013*
DESCRIPTION: Connector Assembly 6F
SIZE: 29.0L x 22.2H x 35.3W
COLOR: Black
MATERIAL: PA66 HS IM
TERMINALS: See Page 18
SEALS/PLUGS: See Page 18
*See Page 19 for alternative material

PART NO: 15355331*
DESCRIPTION: Connector Assembly 4F
SIZE: 29.0L x 22.2H x 28.3W
COLOR: Black
MATERIAL: PA66 HS IM
TERMINALS: See Page 18
SEALS/PLUGS: See Page 18
*See Page 19 for alternative material

B PART NO: 15317832
DESCRIPTION: CPA
COLOR: Gray
MATERIAL: PA6 10% GF & 20% GB

**GT CONNECTOR ASSEMBLY/METRI-PACK SlimLine
CROSS REFERENCE**

GT Connector Assembly	Description	Metri-Pack Pull-To-Seat
15336004, 15355317	Connector Assembly 2F	12162193, 12162194, 12162195
15336121, 15355323	Connector Assembly 3F	12162182, 12162183, 12162184, 12162185, 12162186
15326559, 15355331	Connector Assembly 4F	12124846, 12129192, 12162188, 12162189, 12162190, 12162191
15326389, 15355268	Connector Assembly 5F	12162825, 12162826, 12162827
15336013, 15326829	Connector Assembly 6F	12066317, 12162210, 12162260, 12162261, 12162262

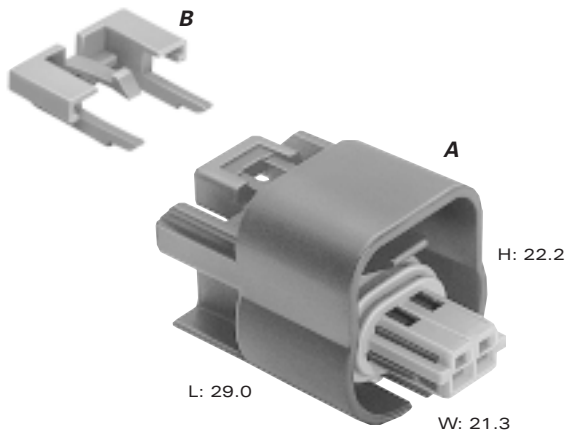

Shrouded Female Key Indexed

A PART NO: 15335987*
 DESCRIPTION: Connector Assembly 2F
 SIZE: 29.0L x 22.2H x 21.3W
 COLOR: Black
 MATERIAL: PA6 10% GF & 20% GB
 TERMINALS: See Page 19
 SEALS/PLUGS: See Page 19
 *See Page 19 for alternative material

PART NO: 15326556*
 DESCRIPTION: Connector Assembly 3F
 SIZE: 29.0L x 22.2H x 24.8W
 COLOR: Black
 MATERIAL: PA66 HS IM
 TERMINALS: See Page 19
 SEALS/PLUGS: See Page 19
 *See Page 19 for alternative material

PART NO: 15336001*
 DESCRIPTION: Connector Assembly 4F
 SIZE: 29.0L x 22.2H x 28.3W
 COLOR: Black
 MATERIAL: PA66 HS IM
 TERMINALS: See Page 19
 SEALS/PLUGS: See Page 19
 *See Page 19 for alternative material

B PART NO: 15317832
 DESCRIPTION: CPA
 COLOR: Gray
 MATERIAL: PA6 10% GF & 20% GB

GT CONNECTOR ASSEMBLY/METRI-PACK *SlimLine* CROSS REFERENCE

GT Connector Assembly	Description	Metri-Pack Pull-To-Seat
15335987, 15355319	Connector Assembly 2F	12162197, 12162198, 12162199
15326556, 15355325	Connector Assembly 3F	12162278, 12162279, 12162280
15336001, 15355329	Connector Assembly 4F	12162833, 12162834



Cross Sectional View

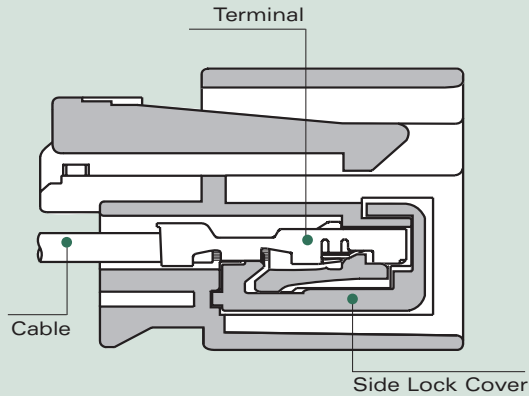

Female Connector Assembly

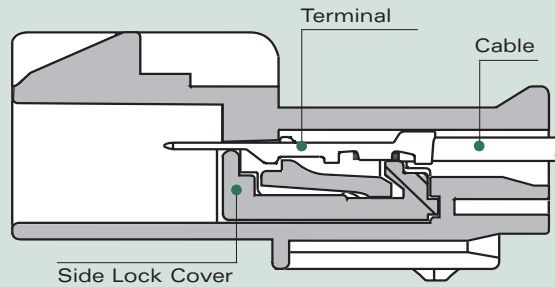

Male Connector Assembly

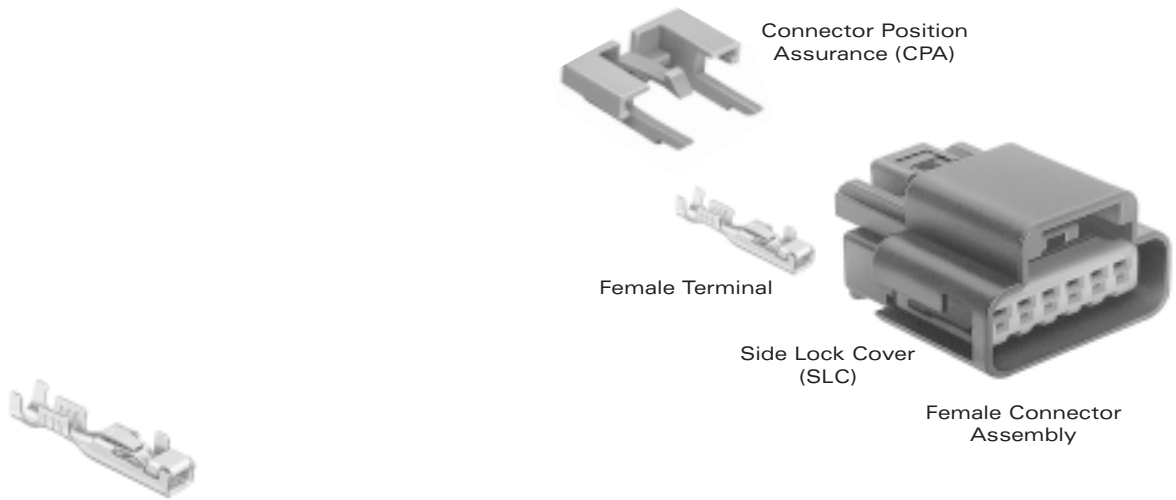

GT 280 FEMALE TERMINALS UNSEALED

Part #	Cable Range (mm ²)	Material	Plating
15304710	0.50-0.35	Tin Brass	Tin
15304711	1.00-0.75	Tin Brass	Tin
15304712	3.00-1.50	Tin Brass	Tin
15304713	5.00-4.00	Tin Brass	Tin

GT 280 FEMALE CONNECTOR ASSEMBLIES UNSEALED

# Cavities	Conn. Asm.	Color	Material
2	15326870	Black	PA6 10% GF & 20% GB
3	15326877	Black	PA6 10% GF & 20% GB
4	15326886	Black	PA6 10% GF & 20% GB
5	15326893	Black	PA6 10% GF & 20% GB
6	15326900	Black	PA6 10% GF & 20% GB
8	15326924	Black	PA6 10% GF & 20% GB
10	15326931	Black	PA6 10% GF & 20% GB
12	15326110	Black	PA6 10% GF & 20% GB
16	15326952	Black	PA6 10% GF & 20% GB

Side Lock Covers (SLC) are included in the Connector Assemblies listed in this section.



Unsealed System Application Information

CABLE RANGE (mm²): 0.35-5.0
CURRENT RANGE (AMPS): 0-25
TEMP RANGE °C: -40 to 125
RESISTANCE: <10mΩ@20mV
VOLTAGE DROP: <4.0mV/amp
CENTERLINE SPACING (mm): 5.5
BLADE WIDTH (mm): 2.8

280 SERIES TERMINALS - Tin Plated

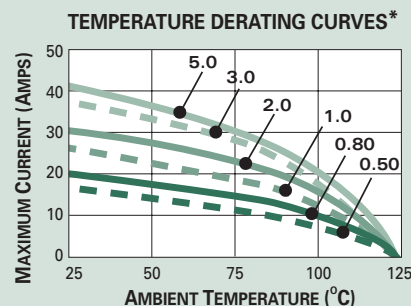
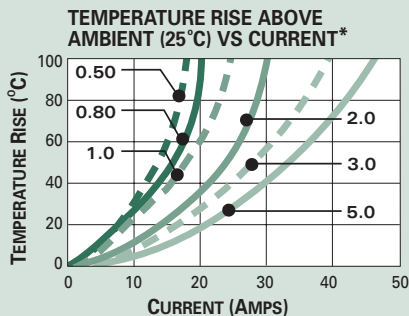

*The test data are based on single circuits in free space and were generated using a "Lumped Resistance" model. This model does not account for all of the variables that would be present in an actual application. For actual product performance, contact your regional support representative at the number listed below.



GT 280 MALE CONNECTOR ASSEMBLIES UNSEALED

# Cavities	Connector	Color	Material
2	15326874	Black	PA6 10% GF & 20% GB
3	15326881	Black	PA6 10% GF & 20% GB
4	15326890	Black	PA6 10% GF & 20% GB
5	15326897	Black	PA6 10% GF & 20% GB
6	15326904	Black	PA6 10% GF & 20% GB
8	15326928	Black	PA6 10% GF & 20% GB
10	15326935	Black	PA6 10% GF & 20% GB
12	15326942	Black	PA6 10% GF & 20% GB
16	15326956	Black	PA6 10% GF & 20% GB

Side Lock Covers (SLC) are included in the Connector Assemblies listed in this section.

GT 280 MALE TERMINALS UNSEALED

Part #	Cable Range (mm ²)	Material	Plating
15304722	0.50-0.35	Tin Brass	Tin
15304723	1.00-0.75	Tin Brass	Tin
15304724	3.00-1.50	Tin Brass	Tin
15304725	5.00-4.00	Tin Brass	Tin

SECTION NOTES:

- Contact your regional support representative at the number listed below.
- Due to rigid tolerances of connector cavities, it is critical to meet all crimp dimensions as specified.
- Special consideration must be used when applying terminals 15304713 and 15304725 due to cavity space limitations.

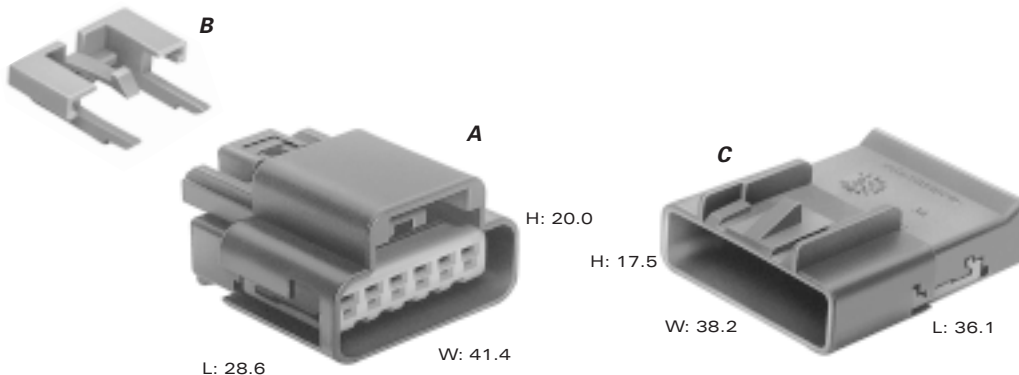

Total Mated Length: 48.7mm

A PART NO: 15326870
 DESCRIPTION: Connector Assembly 2F
 SIZE: 28.6L x 20.0H x 19.4W
 COLOR: Black
 MATERIAL: PA6 10% GF & 20% GB
 TERMINALS: See Page 22

C PART NO: 15326874
 DESCRIPTION: Connector Assembly 2M
 SIZE: 36.1L x 17.5H x 16.2W
 COLOR: Black
 MATERIAL: PA6 10% GF & 20% GB
 TERMINALS: See Page 23

PART NO: 15326877
 DESCRIPTION: Connector Assembly 3F
 SIZE: 28.6L x 20.0H x 24.9W
 COLOR: Black
 MATERIAL: PA6 10% GF & 20% GB
 TERMINALS: See Page 22

PART NO: 15326881
 DESCRIPTION: Connector Assembly 3M
 SIZE: 36.1L x 17.5H x 21.7W
 COLOR: Black
 MATERIAL: PA6 10% GF & 20% GB
 TERMINALS: See Page 23

PART NO: 15326886
 DESCRIPTION: Connector Assembly 4F
 SIZE: 28.6L x 20.0H x 30.4W
 COLOR: Black
 MATERIAL: PA6 10% GF & 20% GB
 TERMINALS: See Page 22

PART NO: 15326890
 DESCRIPTION: Connector Assembly 4M
 SIZE: 36.1L x 17.5H x 27.2W
 COLOR: Black
 MATERIAL: PA6 10% GF & 20% GB
 TERMINALS: See Page 23

PART NO: 15326893†
 DESCRIPTION: Connector Assembly 5F
 SIZE: 28.6L x 20.0H x 35.9W
 COLOR: Black
 MATERIAL: PA6 10% GF & 20% GB
 TERMINALS: See Page 22

PART NO: 15326897
 DESCRIPTION: Connector Assembly 5M
 SIZE: 36.1L x 17.5H x 32.7W
 COLOR: Black
 MATERIAL: PA6 10% GF & 20% GB
 TERMINALS: See Page 23

PART NO: 15326900
 DESCRIPTION: Connector Assembly 6F
 SIZE: 28.6L x 20.0H x 41.4W
 COLOR: Black
 MATERIAL: PA6 10% GF & 20% GB
 TERMINALS: See Page 22

PART NO: 15326904
 DESCRIPTION: Connector Assembly 6M
 SIZE: 36.1L x 17.5H x 38.2W
 COLOR: Black
 MATERIAL: PA6 10% GF & 20% GB
 TERMINALS: See Page 23

B PART NO: 15317832
 DESCRIPTION: CPA
 COLOR: Gray
 MATERIAL: PA6 10% GF & 20% GB

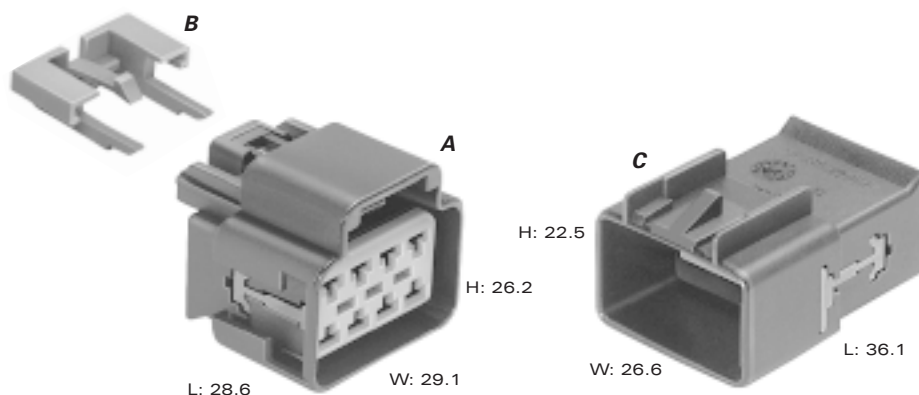

Total Mated Length: 48.7mm

A PART NO: 15326924
 DESCRIPTION: Connector Assembly 8F
 SIZE: 28.6L x 26.2H x 29.1W
 COLOR: Black
 MATERIAL: PA6 10% GF & 20% GB
 TERMINALS: See Page 22

PART NO: 15326931
 DESCRIPTION: Connector Assembly 10F
 SIZE: 28.6L x 26.2H x 34.6W
 COLOR: Black
 MATERIAL: PA6 10% GF & 20% GB
 TERMINALS: See Page 22

PART NO: 15326110
 DESCRIPTION: Connector Assembly 12F
 SIZE: 28.6L x 26.2H x 40.1W
 COLOR: Black
 MATERIAL: PA6 10% GF & 20% GB
 TERMINALS: See Page 22

PART NO: 15326952
 DESCRIPTION: Connector Assembly 16F
 SIZE: 28.6L x 26.2H x 51.1W
 COLOR: Black
 MATERIAL: PA6 10% GF & 20% GB
 TERMINALS: See Page 22

B PART NO: 15317832
 DESCRIPTION: CPA
 COLOR: Gray
 MATERIAL: PA6 10% GF & 20% GB

C PART NO: 15326928
 DESCRIPTION: Connector Assembly 8M
 SIZE: 36.1L x 22.5H x 26.6W
 COLOR: Black
 MATERIAL: PA6 10% GF & 20% GB
 TERMINALS: See Page 23

PART NO: 15326935
 DESCRIPTION: Connector Assembly 10M
 SIZE: 36.1L x 22.5H x 32.1W
 COLOR: Black
 MATERIAL: PA6 10% GF & 20% GB
 TERMINALS: See Page 23

PART NO: 15326942
 DESCRIPTION: Connector Assembly 12M
 SIZE: 36.1L x 22.5H x 37.6W
 COLOR: Black
 MATERIAL: PA6 10% GF & 20% GB
 TERMINALS: See Page 23

PART NO: 15326956
 DESCRIPTION: Connector Assembly 16M
 SIZE: 36.1L x 22.5H x 48.6W
 COLOR: Black
 MATERIAL: PA6 10% GF & 20% GB
 TERMINALS: See Page 23



Cross Sectional View

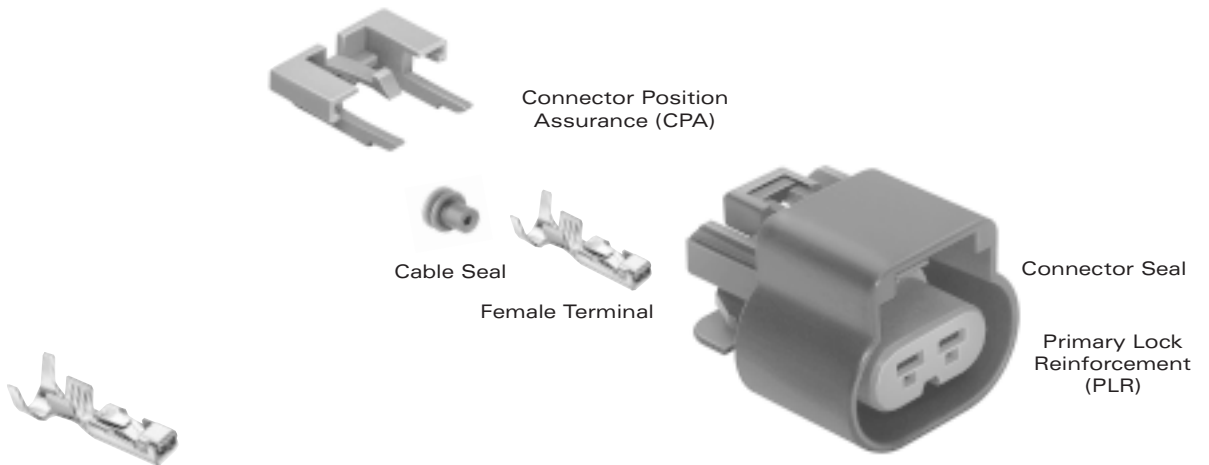
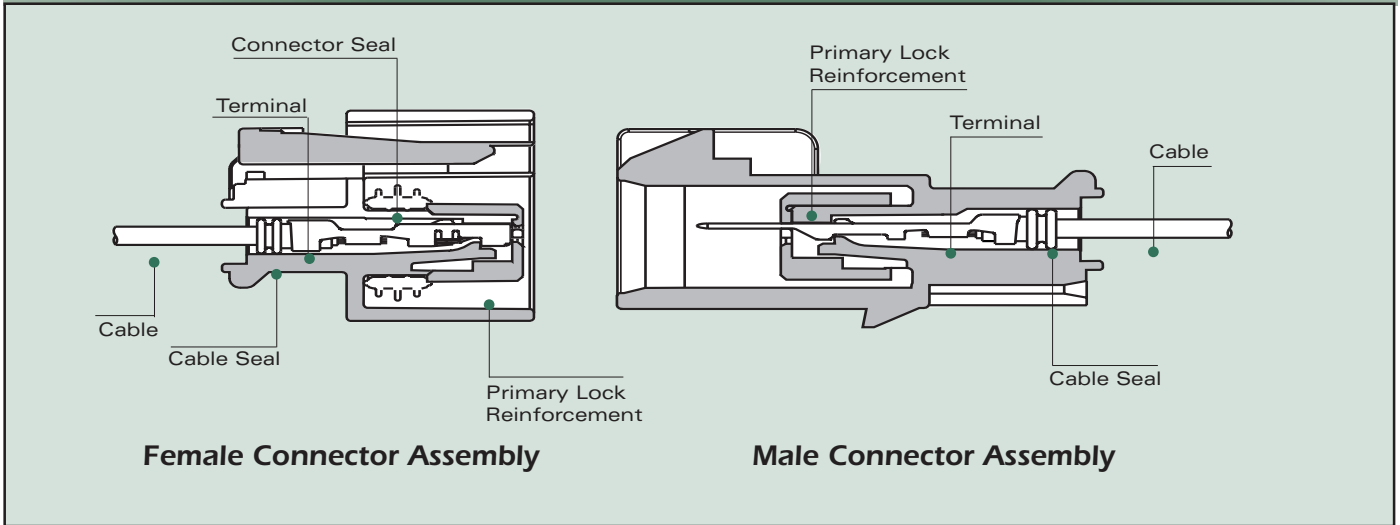

GT 280 FEMALE TERMINALS SEALED

Part #	Cable Range (mm ²)	Material	Plating
15304718	0.50-0.35	Tin Brass	Tin
15304719	1.00-0.75	Tin Brass	Tin
15304720	3.00-1.50	Tin Brass	Tin
15326004	5.00-4.00	Beryllium Copper	Tin



GT 280 CABLE SEALS

Reel Part #	Loose Part #	Cable Diameter	Material	Color
12191221	15366065	1.20-1.85	Silicone	Orange
12191222	15366066	1.86-2.25	Silicone	Yellow
12191223	15366067	2.50-3.20	Silicone	Tan
-	12191235	3.40-3.90	Silicone	Purple

GT 280 FEMALE CONNECTOR ASSEMBLIES SEALED

# Cavities	Conn. Asm.	Color	Material
2	15326679	Black	PA6 10% GF & 20% GB
3	15326614	Black	PA6 10% GF & 20% GB
4	15326631	Black	PA6 10% GF & 20% GB
5	15326642	Black	PA6 10% GF & 20% GB
6	15326635	Black	PA6 10% GF & 20% GB
8	15326654	Black	PA6 10% GF & 20% GB
10	15326660	Black	PA6 10% GF & 20% GB
12	15326910	Black	PA6 10% GF & 20% GB
14	15326917	Black	PA6 10% GF & 20% GB
16	15326666	Black	PA6 10% GF & 20% GB

Primary Lock Reinforcement (PLR) and Connector Seals are included in the Connector Assemblies listed in this section.

<http://delphi.com/products/connect>



Sealed System Application Information



CABLE RANGE (mm²): 0.35-5.0
CURRENT RANGE (AMPS): 0-25
TEMP RANGE °C: -40 to 125
RESISTANCE: <10mΩ@20mV
VOLTAGE DROP: <4.0mV/amp
CENTERLINE SPACING (mm): 6.5
BLADE WIDTH (mm): 2.8

280 SERIES TERMINALS - Tin Plated

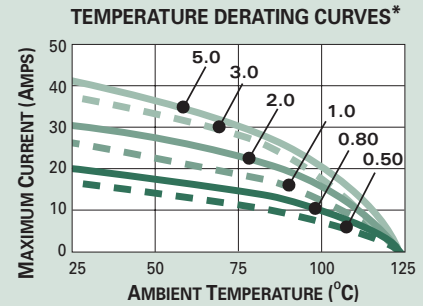
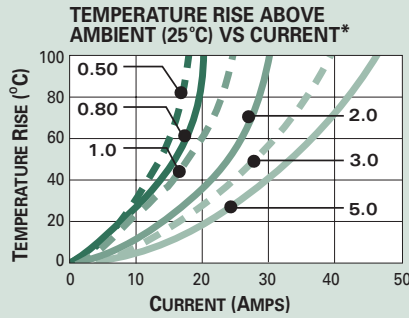

*The test data are based on single circuits in free space and were generated using a "Lumped Resistance" model. This model does not account for all of the variables that would be present in an actual application. For actual product performance, contact your regional support representative at the listed below.

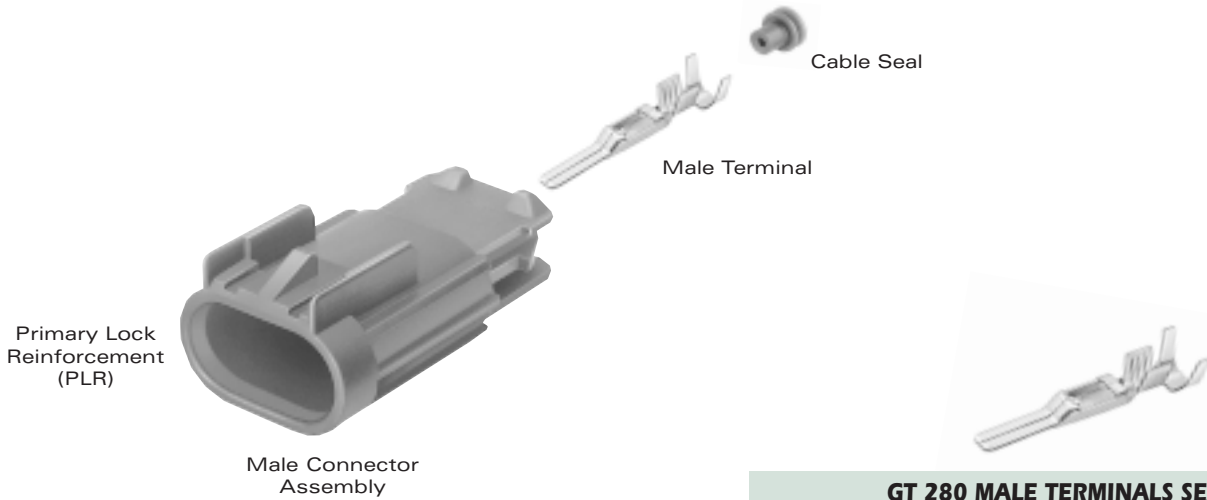

GT 280 MALE CONNECTOR ASSEMBLIES SEALED			
# Cavities	Connector	Color	Material
2	15326678	Black	PA6 10% GF & 20% GB
3	15326623	Black	PA6 10% GF & 20% GB
4	15326633	Black	PA6 10% GF & 20% GB
5	15326647	Black	PA6 10% GF & 20% GB
6	15326640	Black	PA6 10% GF & 20% GB
8	15326655	Black	PA6 10% GF & 20% GB
10	15326661	Black	PA6 10% GF & 20% GB
12	15326915	Black	PA6 10% GF & 20% GB
14	15326922	Black	PA6 10% GF & 20% GB
16	15326667	Black	PA6 10% GF & 20% GB

Primary Lock Reinforcement is included in the Connector Assemblies listed in this section.

GT 280 MALE TERMINALS SEALED			
Part #	Cable Range (mm ²)	Material	Plating
15304730	0.50-0.35	Tin Brass	Tin
15304731	1.00-0.75	Tin Brass	Tin
15304732	3.00-1.50	Tin Brass	Tin

GT 280 CAVITY PLUG*			
Part #	Cavity Diameter	Material	Color
15305170	5.8mm	Silicone	White

*Cavity plugs seal unused female and male cavities.

SECTION NOTES:

- Contact your regional support representative at the number listed below.
- Due to rigid tolerances of connector cavities, it is critical to meet all crimp dimensions as specified.

<http://delphi.com/products/connect>

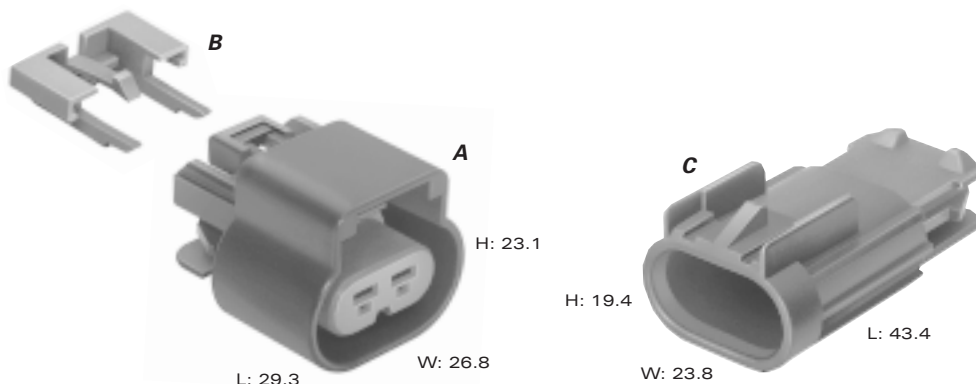

Total Mated Length: 56.7mm

A PART NO: 15326679
 DESCRIPTION: Connector Assembly 2F
 SIZE: 29.3L x 23.1H x 26.8W
 COLOR: Black
 MATERIAL: PA6 10% GF & 20% GB
 TERMINALS: See Page 26
 SEALS/PLUGS: See Page 26, 27

C PART NO: 15326678
 DESCRIPTION: Connector Assembly 2M
 SIZE: 43.4L x 19.4H x 23.8W
 COLOR: Black
 MATERIAL: PA6 10% GF & 20% GB
 TERMINALS: See Page 27
 SEALS/PLUGS: See Page 26, 27

PART NO: 15326614
 DESCRIPTION: Connector Assembly 3F
 SIZE: 29.3L x 23.1H x 33.3W
 COLOR: Black
 MATERIAL: PA6 10% GF & 20% GB
 TERMINALS: See Page 26
 SEALS/PLUGS: See Page 26, 27

PART NO: 15326623
 DESCRIPTION: Connector Assembly 3M
 SIZE: 43.4L x 19.4H x 30.3W
 COLOR: Black
 MATERIAL: PA6 10% GF & 20% GB
 TERMINALS: See Page 27
 SEALS/PLUGS: See Page 26, 27

PART NO: 15326631
 DESCRIPTION: Connector Assembly 4F
 SIZE: 29.3L x 23.1H x 39.8W
 COLOR: Black
 MATERIAL: PA6 10% GF & 20% GB
 TERMINALS: See Page 26
 SEALS/PLUGS: See Page 26, 27

PART NO: 15326633
 DESCRIPTION: Connector Assembly 4M
 SIZE: 43.4L x 19.4H x 36.8W
 COLOR: Black
 MATERIAL: PA6 10% GF & 20% GB
 TERMINALS: See Page 27
 SEALS/PLUGS: See Page 26, 27

PART NO: 15326642
 DESCRIPTION: Connector Assembly 5F
 SIZE: 29.3L x 23.1H x 46.3W
 COLOR: Black
 MATERIAL: PA6 10% GF & 20% GB
 TERMINALS: See Page 26
 SEALS/PLUGS: See Page 26, 27

PART NO: 15326647
 DESCRIPTION: Connector Assembly 5M
 SIZE: 43.4L x 19.4H x 43.3W
 COLOR: Black
 MATERIAL: PA6 10% GF & 20% GB
 TERMINALS: See Page 27
 SEALS/PLUGS: See Page 26, 27

PART NO: 15326635
 DESCRIPTION: Connector Assembly 6F
 SIZE: 29.3L x 23.1H x 52.8W
 COLOR: Black
 MATERIAL: PA6 10% GF & 20% GB
 TERMINALS: See Page 26
 SEALS/PLUGS: See Page 26, 27

PART NO: 15326640
 DESCRIPTION: Connector Assembly 6M
 SIZE: 43.4L x 19.4H x 49.8W
 COLOR: Black
 MATERIAL: PA6 10% GF & 20% GB
 TERMINALS: See Page 27
 SEALS/PLUGS: See Page 26, 27

B PART NO: 15317832
 DESCRIPTION: CPA
 COLOR: Gray
 MATERIAL: PA6 10% GF & 20% GB

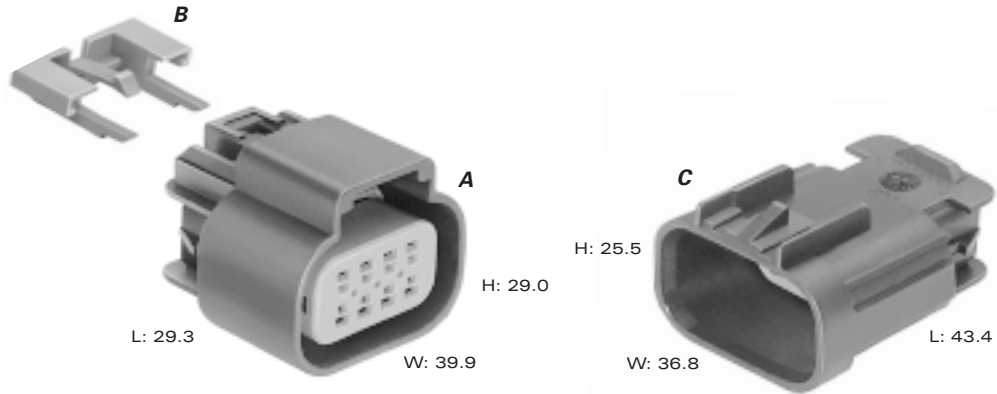

Total Mated Length: 56.7mm

A PART NO: 15326654
 DESCRIPTION: Connector Assembly 8F
 SIZE: 29.3L x 29.0H x 39.9W
 COLOR: Black
 MATERIAL: PA6 10% GF & 20% GB
 TERMINALS: See Page 26
 SEALS/PLUGS: See Page 26, 27

PART NO: 15326660
 DESCRIPTION: Connector Assembly 10F
 SIZE: 29.3L x 29.0H x 46.4W
 COLOR: Black
 MATERIAL: PA6 10% GF & 20% GB
 TERMINALS: See Page 26
 SEALS/PLUGS: See Page 26, 27

PART NO: 15326910
 DESCRIPTION: Connector Assembly 12F
 SIZE: 29.3L x 29.0H x 52.9W
 COLOR: Black
 MATERIAL: PA6 10% GF & 20% GB
 TERMINALS: See Page 26
 SEALS/PLUGS: See Page 26, 27

PART NO: 15326917
 DESCRIPTION: Connector Assembly 14F
 SIZE: 29.3L x 29.0H x 59.4W
 COLOR: Black
 MATERIAL: PA6 10% GF & 20% GB
 TERMINALS: See Page 26
 SEALS/PLUGS: See Page 26, 27

PART NO: 15326666
 DESCRIPTION: Connector Assembly 16F
 SIZE: 29.3L x 29.0H x 65.9W
 COLOR: Black
 MATERIAL: PA6 10% GF & 20% GB
 TERMINALS: See Page 26
 SEALS/PLUGS: See Page 26, 27

B PART NO: 15317832
 DESCRIPTION: CPA
 COLOR: Gray
 MATERIAL: PA6 10% GF & 20% GB

C PART NO: 15326655
 DESCRIPTION: Connector Assembly 8M
 SIZE: 43.4L x 25.5H x 36.8W
 COLOR: Black
 MATERIAL: PA6 10% GF & 20% GB
 TERMINALS: See Page 27
 SEALS/PLUGS: See Page 26, 27

PART NO: 15326661
 DESCRIPTION: Connector Assembly 10M
 SIZE: 43.4L x 25.5H x 43.3W
 COLOR: Black
 MATERIAL: PA6 10% GF & 20% GB
 TERMINALS: See Page 27
 SEALS/PLUGS: See Page 26, 27

PART NO: 15326915
 DESCRIPTION: Connector Assembly 12M
 SIZE: 43.4L x 25.5H x 49.8W
 COLOR: Black
 MATERIAL: PA6 10% GF & 20% GB
 TERMINALS: See Page 27
 SEALS/PLUGS: See Page 26, 27

PART NO: 15326922
 DESCRIPTION: Connector Assembly 14M
 SIZE: 43.4L x 25.5H x 56.3W
 COLOR: Black
 MATERIAL: PA6 10% GF & 20% GB
 TERMINALS: See Page 27
 SEALS/PLUGS: See Page 26, 27

PART NO: 15326667
 DESCRIPTION: Connector Assembly 16M
 SIZE: 43.4L x 25.5H x 62.8W
 COLOR: Black
 MATERIAL: PA6 10% GF & 20% GB
 TERMINALS: See Page 27
 SEALS/PLUGS: See Page 26, 27



GT 280 Connection Systems are designed to mate to most headlamps, including a variety of daytime running lamps, high beam, and dual filament BULBS.

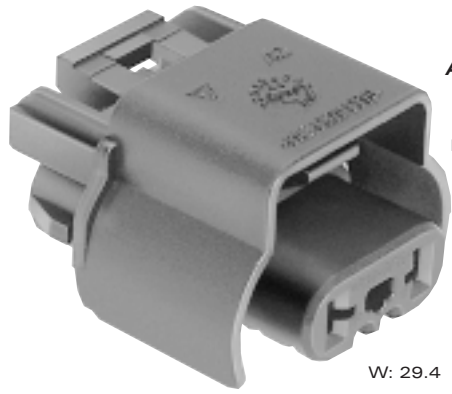

A

H: 23.8

W: 29.4

L: 35.8

- A PART NO: 15336116**
 DESCRIPTION: Connector Assembly 2F
 SIZE: 35.8L x 23.8H x 29.4W
 COLOR: Black
 MATERIAL: PA6 20% GF & 10% GB
 TERMINALS: See Page 26
 SEALS/PLUGS: See Page 84, 85



B

H: 23.8

W: 29.4

L: 35.8

- B PART NO: 15336117**
 DESCRIPTION: Connector Assembly 2F
 SIZE: 35.8L x 23.8H x 29.4W
 COLOR: Brown
 MATERIAL: PA6 20% GF & 10% GB
 TERMINALS: See Page 26
 SEALS/PLUGS: See Page 84, 85



Cross Sectional View

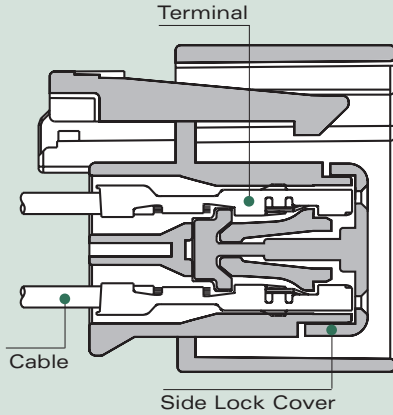

Female Connector Assembly

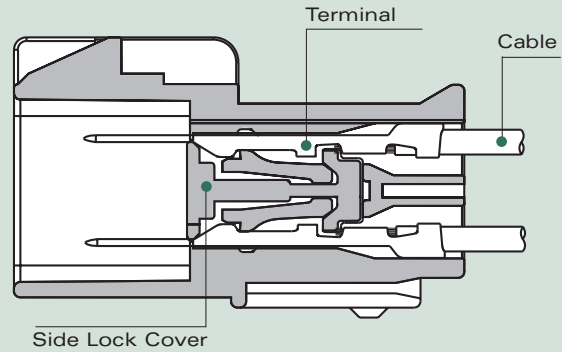

Male Connector Assembly

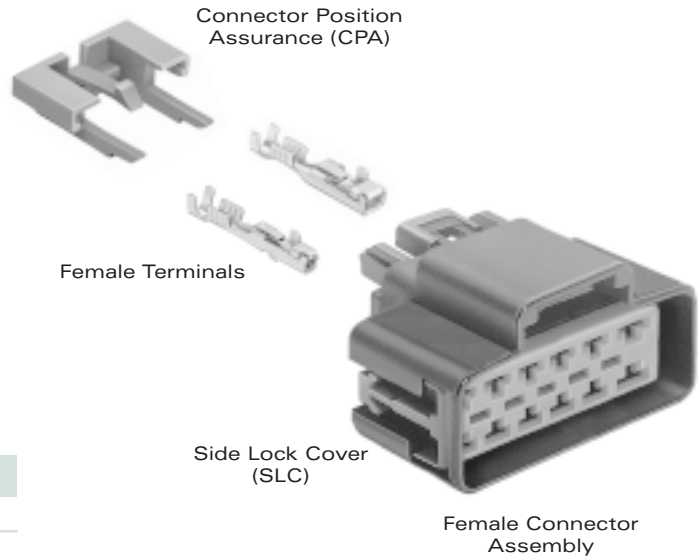

GT 150 FEMALE TERMINALS UNSEALED

Part #	Cable Range (mm ²)	Material	Plating
12191811	0.50-0.35	Tin Brass	Tin
12191812	1.00-0.75	Tin Brass	Tin

GT 280 FEMALE TERMINALS UNSEALED

Part #	Cable Range (mm ²)	Material	Plating
15304710	0.50-0.35	Tin Brass	Tin
15304711	1.00-0.75	Tin Brass	Tin
15304712	3.00-1.50	Tin Brass	Tin
15304713	5.00-4.00	Tin Brass	Tin

GT MIXED FEMALE CONNECTOR ASSEMBLIES UNSEALED

# Cavities	Connector	Color	Material
12	15336205	Black	PA6 10% GF & 20% GB
16	15336219	Black	PA6 10% GF & 20% GB
18	15326082	Black	PA6 10% GF & 20% GB

Side Lock Covers (SLC) are included in the Connector Assemblies listed in this section.

<http://delphi.com/products/connect>



Unsealed System Application Information

GT 150 SERIES TERMINALS-Tin Plated

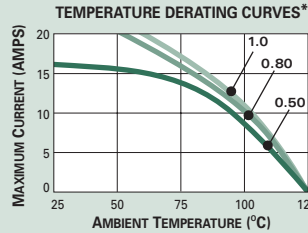
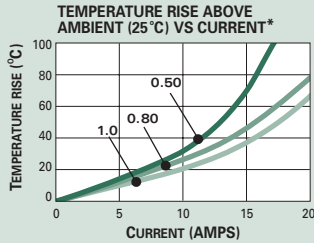

CABLE RANGE (mm²): 0.35-1.0
 CURRENT RANGE (AMPS): 0-15
 TEMP RANGE °C: -40 to 125
 RESISTANCE: <10mΩ@20mV

VOLTAGE DROP: <10.0mV/amp
 CENTERLINE SPACING (mm): 4.0
 BLADE WIDTH (mm): 1.5

280 SERIES TERMINALS - Tin Plated

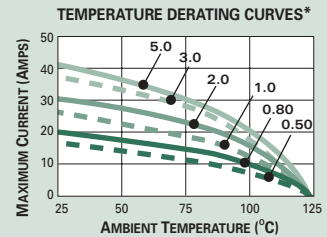
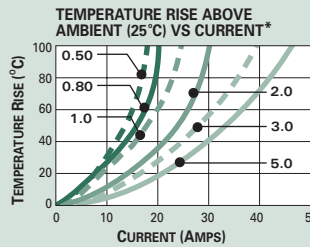

CABLE RANGE (mm²): 0.35-5.0
 CURRENT RANGE (AMPS): 0-25
 TEMP RANGE °C: -40 to 125
 RESISTANCE: <10mΩ@20mV

VOLTAGE DROP: <4.0mV/amp
 CENTERLINE SPACING (mm): 5.5
 BLADE WIDTH (mm): 2.8

* The test data are based on single circuits in free space and were generated using a "Lumped Resistance" model. This model does not account for all of the variables that would be present in an actual application. For actual product performance contact your regional support representative at the number listed below.

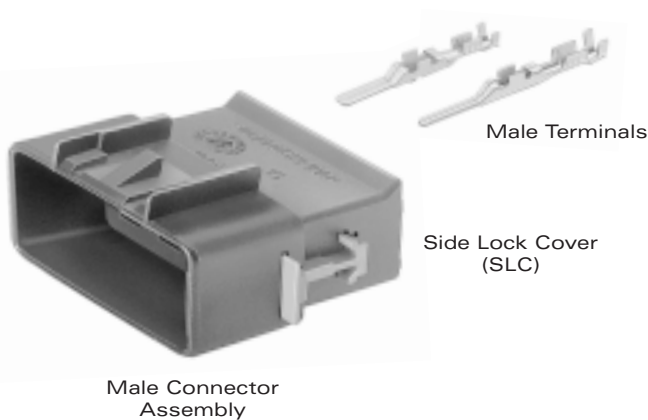

GT 150 MALE TERMINALS UNSEALED

Part #	Cable Range (mm ²)	Material	Plating
15304701	0.50-0.35	Tin Brass	Tin
15304702	1.00-0.75	Tin Brass	Tin

GT 280 MALE TERMINALS UNSEALED

Part #	Cable Range (mm ²)	Material	Plating
15304722	0.50-0.35	Tin Brass	Tin
15304723	1.00-0.75	Tin Brass	Tin
15304724	3.00-1.50	Tin Brass	Tin
15304725	5.00-4.00	Tin Brass	Tin

GT MIXED MALE CONNECTOR ASSEMBLIES UNSEALED

# Cavities	Connector	Color	Material
12	15336209	Black	PA6 10% GF & 20% GB
16	15336224	Black	PA6 10% GF & 20% GB

Side Lock Covers (SLC) are included in the Connector Assemblies listed in this section.

SECTION NOTES:

- Contact your regional support representative at the number listed below.
- Due to rigid tolerances of connector cavities, it is critical to meet all crimp dimensions as specified.
- Special consideration must be used when applying terminals 15304713 and 15304725 due to cavity space limitations.

<http://delphi.com/products/connect>

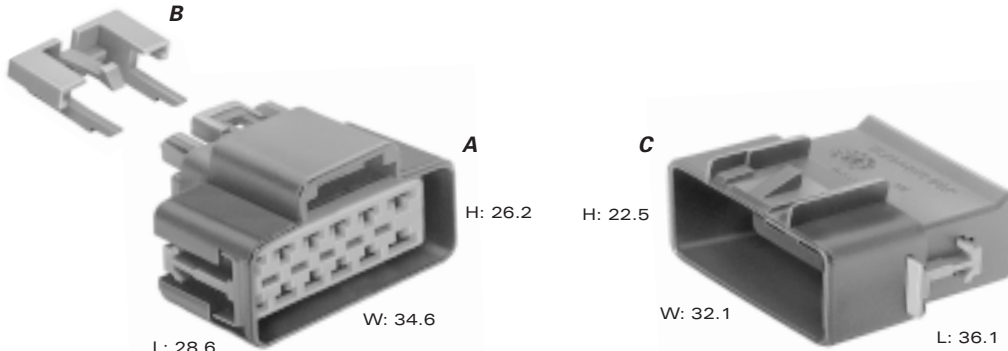

Total Mated Length: 56.7mm

A PART NO: 15336205

DESCRIPTION: Connector Assembly 12F
 SIZE: 28.6L x 26.2H x 34.6W
 COLOR: Black
 MATERIAL: PA6 10% GF & 20% GB
 TERMINALS: See Page 32

PART NO: 15336219

DESCRIPTION: Connector Assembly 16F
 SIZE: 28.6L x 26.2H x 42.6W
 COLOR: Black
 MATERIAL: PA6 10% GF & 20% GB
 TERMINALS: See Page 32

PART NO: 15326082

DESCRIPTION: Connector Assembly 18F
 SIZE: 28.6L x 26.2H x 46.6W
 COLOR: Black
 MATERIAL: PA6 10% GF & 20% GB
 TERMINALS: See Page 32

B PART NO: 15317832

DESCRIPTION: CPA
 COLOR: Gray
 MATERIAL: PA6 10% GF & 20% GB

C PART NO: 15336209

DESCRIPTION: Connector Assembly 12M
 SIZE: 36.1L x 22.5H x 32.1W
 COLOR: Black
 MATERIAL: PA6 10% GF & 20% GB
 TERMINALS: See Page 33

PART NO: 15336224

DESCRIPTION: Connector Assembly 16M
 SIZE: 36.1L x 22.5H x 40.1W
 COLOR: Black
 MATERIAL: PA6 10% GF & 20% GB
 TERMINALS: See Page 33

KEY:

- ▣ 150 SERIES
- 280 SERIES

Mixed connectors feature a combination of different terminal cavities, as indicated by the key.

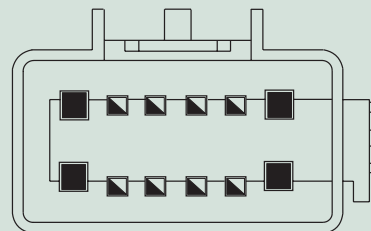
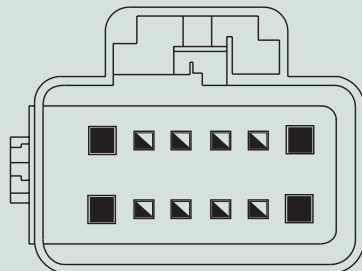



Cross Sectional View

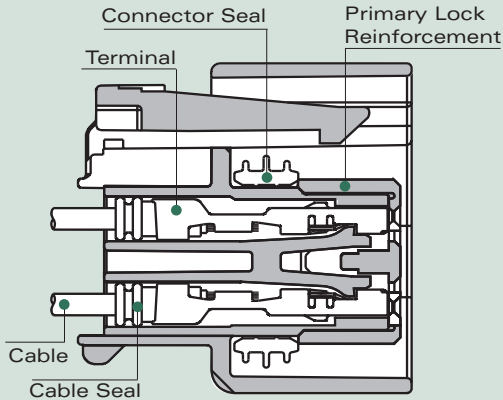

Female Connector Assembly

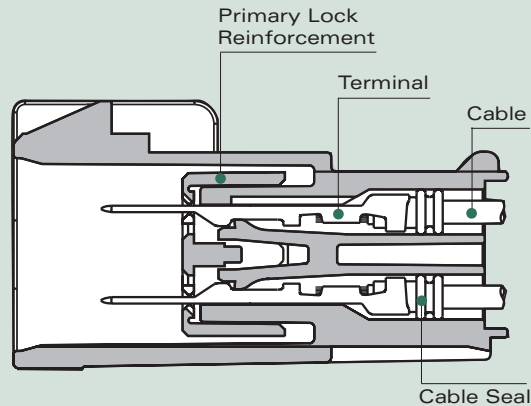

Male Connector Assembly

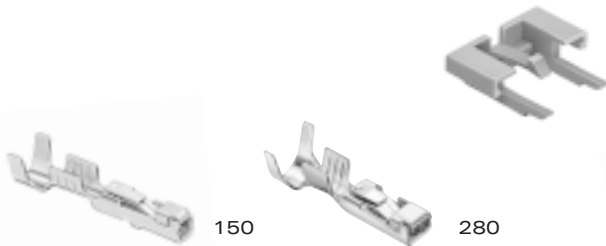

150

280

Connector Position Assurance (CPA)

Cable Seals

Female Terminals



Primary Lock Reinforcement (PLR)

Female Connector Assembly

GT 150 FEMALE TERMINALS SEALED

Part #	Cable Range (mm ²)	Material	Plating
12191818	0.50-0.35	Tin Brass	Tin
12191819	1.00-0.75	Tin Brass	Tin

GT 280 FEMALE TERMINALS SEALED

Part #	Cable Range (mm ²)	Material	Plating
15304718	0.50-0.35	Tin Brass	Tin
15304719	1.00-0.75	Tin Brass	Tin
15304720	3.00-1.50	Tin Brass	Tin
15326004	5.00-4.00	Beryllium Copper	Tin



150



280

GT 150 CABLE SEALS

Reel Part #	Loose Part #	Cable Diameter	Material	Color
12191152	15366021	1.20-1.85	Silicone	White
12191153	15366060	1.86-2.25	Silicone	Blue

GT 280 CABLE SEALS

Reel Part #	Loose Part #	Cable Diameter	Material	Color
12191221	15366065	1.20-1.85	Silicone	Orange
12191222	15366066	1.86-2.25	Silicone	Yellow
12191223	15366067	2.50-3.20	Silicone	Tan
-	12191235	3.40-3.90	Silicone	Purple

GT MIXED FEMALE CONNECTOR ASSEMBLIES SEALED

# Cavities	Connector	Color	Material
12	15326939	Black	PA6 10% GF & 20% GB
14	15336037	Black	PA6 10% GF & 20% GB
16	15326084	Black	PA6 10% GF & 20% GB

Primary Lock Reinforcement (PLR) and Connector Seals are included in the Connector Assemblies listed in this section.



Sealed System Application Information

GT 150 SERIES TERMINALS-Tin Plated

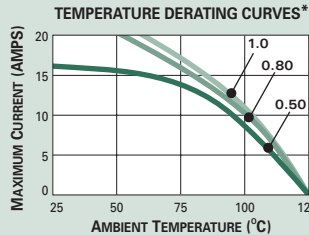
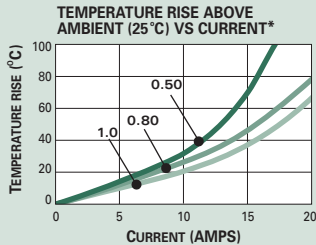

CABLE RANGE (mm²): 0.35-1.0
 CURRENT RANGE (AMPS): 0-15
 TEMP RANGE °C: -40 to 125
 RESISTANCE: <10mΩ@20mV

VOLTAGE DROP: <10.0mV/amp
 CENTERLINE SPACING (mm): 4.5
 BLADE WIDTH (mm): 1.5

280 SERIES TERMINALS - Tin Plated

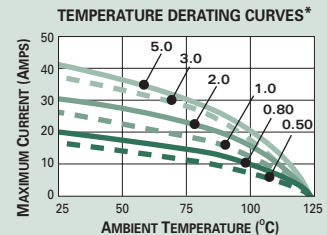
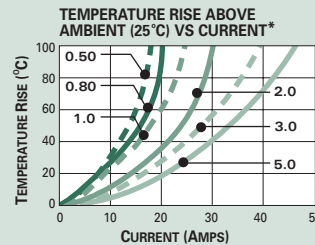

CABLE RANGE (mm²): 0.35-5.0
 CURRENT RANGE (AMPS): 0-25
 TEMP RANGE °C: -40 to 125
 RESISTANCE: <10mΩ@20mV

VOLTAGE DROP: <4.0mV/amp
 CENTERLINE SPACING (mm): 6.5
 BLADE WIDTH (mm): 2.8

* The test data are based on single circuits in free space and were generated using a "Lumped Resistance" model. This model does not account for all of the variables that would be present in an actual application. For actual product performance, contact your regional support representative at the number listed below.

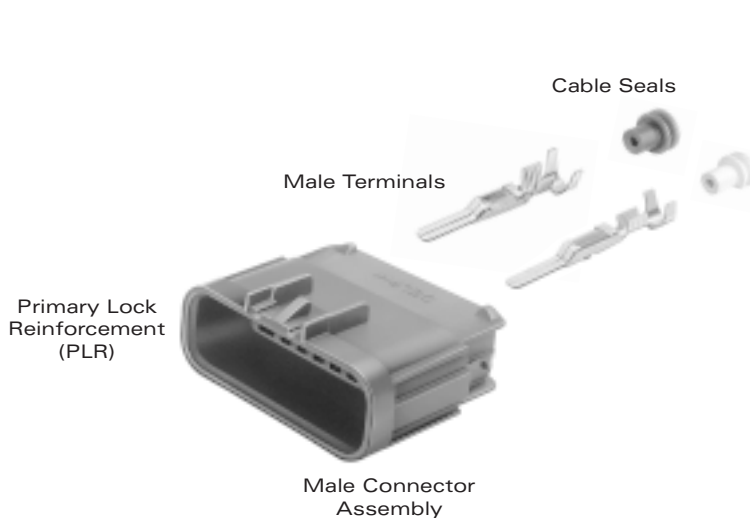

GT 150 MALE TERMINALS SEALED

Part #	Cable Range (mm ²)	Material	Plating
15326268	0.50-0.35	Tin Brass	Tin
15326269	1.00-0.75	Tin Brass	Tin

GT 280 MALE TERMINALS SEALED

Part #	Cable Range (mm ²)	Material	Plating
15304730	0.50-0.35	Tin Brass	Tin
15304731	1.00-0.75	Tin Brass	Tin
15304732	3.00-1.50	Tin Brass	Tin

GT 150 CAVITY PLUG*

Part #	Cavity Diameter	Material	Color
15305171	4.0mm	Silicone	Green

*Cavity plugs seal unused female and male cavities.

GT 280 CAVITY PLUG*

Part #	Cavity Diameter	Material	Color
15305170	5.8mm	Silicone	White

*Cavity plugs seal unused female and male cavities.

GT MIXED MALE CONNECTOR ASSEMBLIES SEALED

# Cavities	Connector	Color	Material
12	15336034	Black	PA6 10% GF & 20% GB
14	15422562	Black	PA6 10% GF & 20% GB
16	15326085	Black	PA6 10% GF & 20% GB

Primary Lock Reinforcement (PLR) is included in the Connector Assemblies listed in this section.

SECTION NOTES:

- Contact your regional support representative at the number listed below.
- Due to rigid tolerances of connector cavities, it is critical to meet all crimp dimensions as specified.

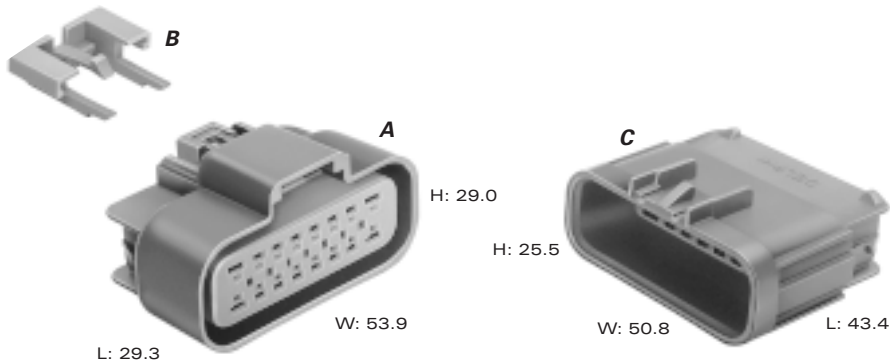

Total Mated Length: 56.7mm

A PART NO: 15326939
 DESCRIPTION: Connector Assembly 12F
 SIZE: 29.3L x 29.0H x 44.9W
 COLOR: Black
 MATERIAL: PA6 10% GF & 20% GB
 TERMINALS: See Page 36
 SEALS/PLUGS: See Page 36, 37

C PART NO: 15336034
 DESCRIPTION: Connector Assembly 12M
 SIZE: 43.4L x 25.5H x 41.8W
 COLOR: Black
 MATERIAL: PA6 10% GF & 20% GB
 TERMINALS: See Page 37
 SEALS/PLUGS: See Page 36, 37

PART NO: 15336037
 DESCRIPTION: Connector Assembly 14F
 SIZE: 29.3L x 29.0H x 49.4W
 COLOR: Black
 MATERIAL: PA6 10% GF & 20% GB
 TERMINALS: See Page 36
 SEALS/PLUGS: See Page 36, 37

PART NO: 15422562
 DESCRIPTION: Connector Assembly 14M
 SIZE: 43.4L x 25.5H x 46.3W
 COLOR: Black
 MATERIAL: PA6 10% GF & 20% GB
 TERMINALS: See Page 37
 SEALS/PLUGS: See Page 36, 37

PART NO: 15326084
 DESCRIPTION: Connector Assembly 16F
 SIZE: 29.3L x 29.0H x 53.9W
 COLOR: Black
 MATERIAL: PA6 10% GF & 20% GB
 TERMINALS: See Page 36
 SEALS/PLUGS: See Page 36, 37

PART NO: 15326085
 DESCRIPTION: Connector Assembly 16M
 SIZE: 43.4L x 25.5H x 50.8W
 COLOR: Black
 MATERIAL: PA6 10% GF & 20% GB
 TERMINALS: See Page 37
 SEALS/PLUGS: See Page 36, 37

B PART NO: 15317832
 DESCRIPTION: CPA
 COLOR: Gray
 MATERIAL: PA6 10% GF & 20% GB

KEY:

- ▣ 150 SERIES
- 280 SERIES

Mixed connectors feature a combination of different terminal cavities, as indicated by the key.

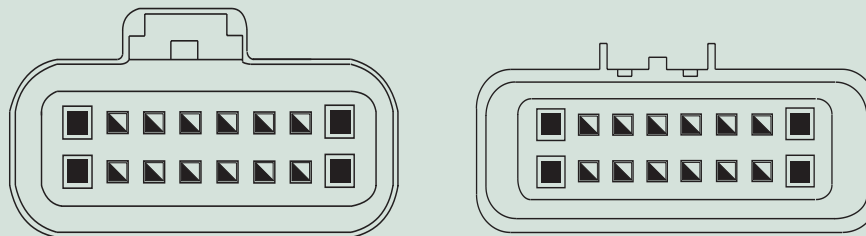



Cross Sectional View

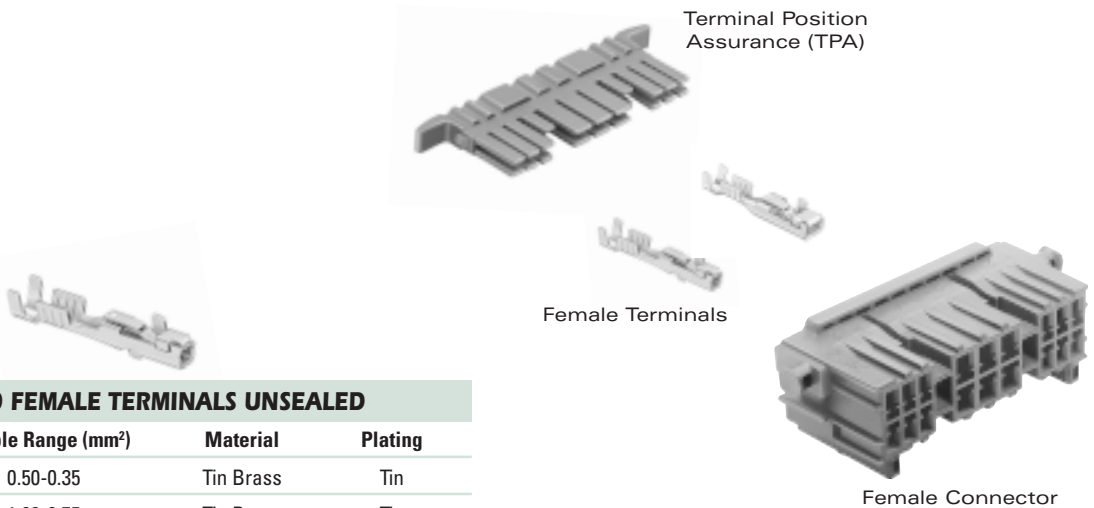
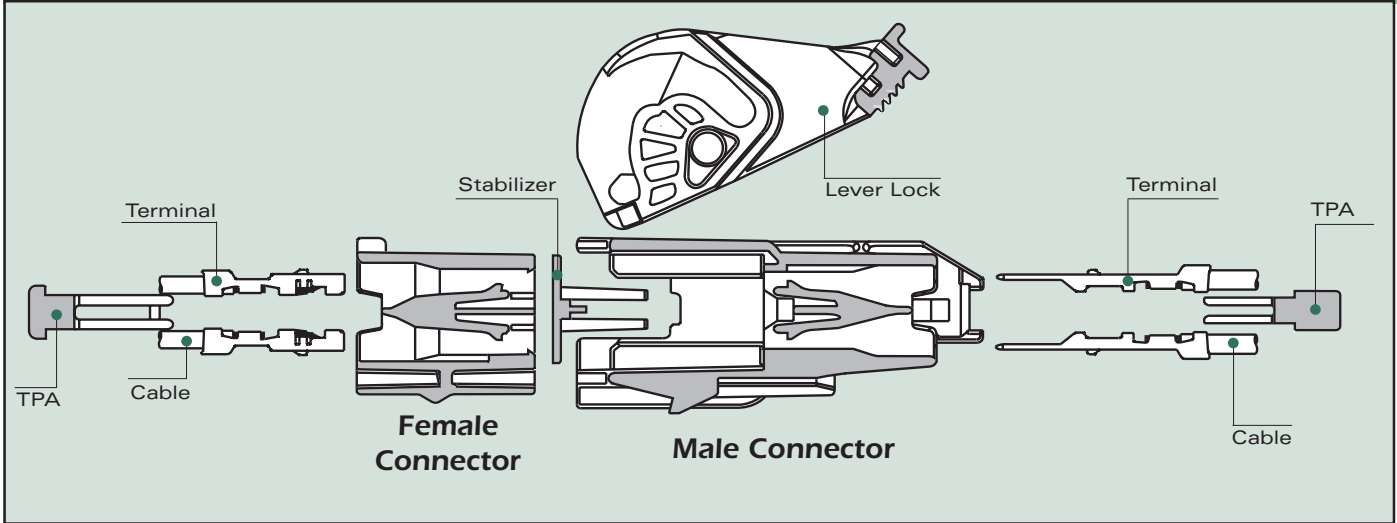

GT 150 FEMALE TERMINALS UNSEALED

Part #	Cable Range (mm ²)	Material	Plating
12191811	0.50-0.35	Tin Brass	Tin
12191812	1.00-0.75	Tin Brass	Tin

GT 280 FEMALE TERMINALS UNSEALED

Part #	Cable Range (mm ²)	Material	Plating
15304710	0.50-0.35	Tin Brass	Tin
15304711	1.00-0.75	Tin Brass	Tin
15304712	3.00-1.50	Tin Brass	Tin
15304713	5.00-4.00	Tin Brass	Tin

GT FEMALE LEVER LOCK CONNECTORS UNSEALED

# Cavities	Connector	Color	Material	TPA
18	15304692	Black	PA66 HS IM	15304694
22	15317325	Lt. Gray	PA66 HS IM	15317326
30	15304908	Black	PA66 HS IM	15304913
40	15359287	Black	PA66 HS IM	15304842

<http://delphi.com/products/connect>



Unsealed System Application Information

GT 150 SERIES TERMINALS-Tin Plated

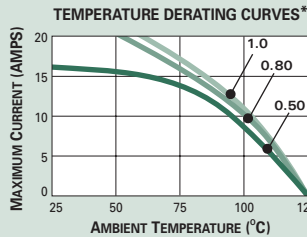
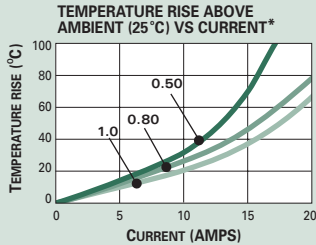

CABLE RANGE (mm²): 0.35-1.0
 CURRENT RANGE (AMPS): 0-15
 TEMP RANGE °C: -40 to 125
 RESISTANCE: <10mΩ@20mV

VOLTAGE DROP: <10.0mV/amp
 CENTERLINE SPACING (mm): 4.0
 BLADE WIDTH (mm): 1.5

280 SERIES TERMINALS - Tin Plated

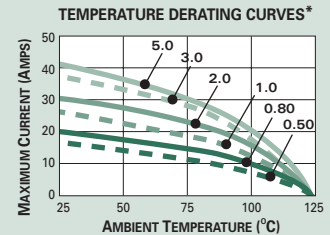
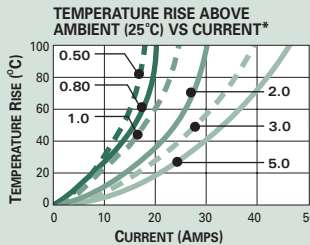

CABLE RANGE (mm²): 0.35-5.0
 CURRENT RANGE (AMPS): 0-25
 TEMP RANGE °C: -40 to 125
 RESISTANCE: <10mΩ@20mV

VOLTAGE DROP: <4.0mV/amp
 CENTERLINE SPACING (mm): 5.5
 BLADE WIDTH (mm): 2.8

* The test data are based on single circuits in free space and were generated using a "Lumped Resistance" model. This model does not account for all of the variables that would be present in an actual application. For actual product performance, contact your regional support representative at the number listed below.

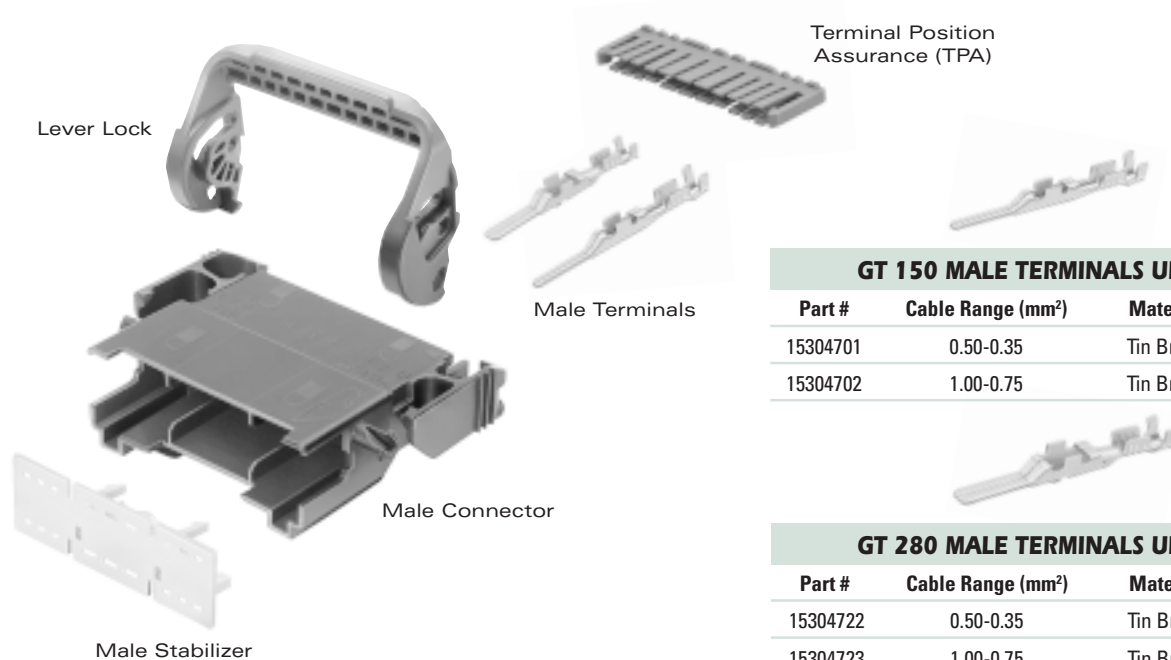

GT 150 MALE TERMINALS UNSEALED

Part #	Cable Range (mm ²)	Material	Plating
15304701	0.50-0.35	Tin Brass	Tin
15304702	1.00-0.75	Tin Brass	Tin

GT 280 MALE TERMINALS UNSEALED

Part #	Cable Range (mm ²)	Material	Plating
15304722	0.50-0.35	Tin Brass	Tin
15304723	1.00-0.75	Tin Brass	Tin
15304724	3.00-1.50	Tin Brass	Tin
15304725	5.00-4.00	Tin Brass	Tin

GT MALE LEVER LOCK CONNECTORS UNSEALED

# Cavities	Connector	Color	Material	TPA	Stabilizer	Lever Lock
18	15336468	Black	PA66 HS IM	15304695	15418982	15317550
22	15317322	Lt. Gray	PA66 HS IM	15317323	15418983	15317321
30	15326762	Black	PA66 HS IM	15304912	15418984	15326799
40	15336417	Black	PA66 HS IM	15304841	15326177	15336387

SECTION NOTES:

- Contact your regional support representative at the number listed below.
- Due to rigid tolerances of connector cavities, it is critical to meet all crimp dimensions as specified.
- Special consideration must be used when applying terminals 15304713 and 15304725 due to cavity space limitations.

<http://delphi.com/products/connect>

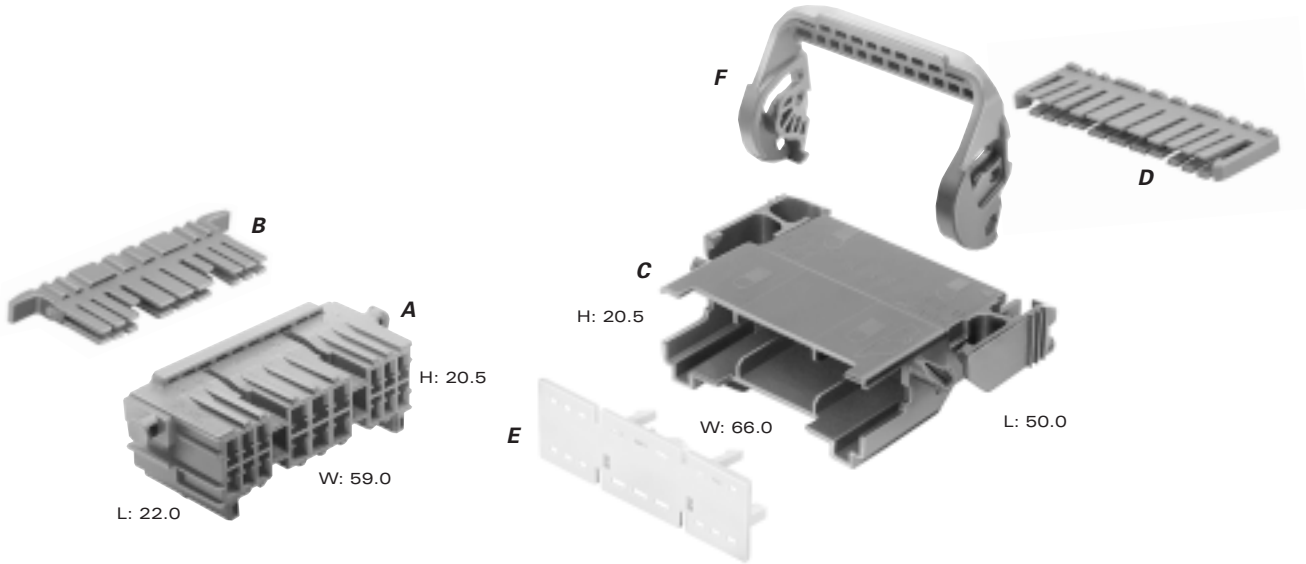

Total Mated Length: 63.8mm

A PART NO: 15304692 (Black)
15304690 (Md. Gray)
DESCRIPTION: Connector 18F
SIZE: 22.0L x 20.5H x 59.0W
MATERIAL: PA66 HS IM
TERMINALS: See Page 40

C PART NO: 15336468 (Black)
15336467 (Md. Gray)
DESCRIPTION: Connector 18M
SIZE: 50.0L x 20.5H x 66.0W
MATERIAL: PA66 HS IM
TERMINALS: See Page 41
CLIP: 12084149

B PART NO: 15304694
DESCRIPTION: TPA
COLOR: Blue
MATERIAL: PBT

D PART NO: 15304695
DESCRIPTION: TPA
COLOR: Blue
MATERIAL: PBT

E PART NO: 15418982
DESCRIPTION: Stabilizer
COLOR: Natural
MATERIAL: PA66 HS IM

F PART NO: 15317550
DESCRIPTION: Lever Lock
COLOR: Purple
MATERIAL: PA66 HS IM

KEY:

- ▣ 150 SERIES
- 280 SERIES

Mixed connectors feature a combination of different terminal cavities, as indicated by the key.

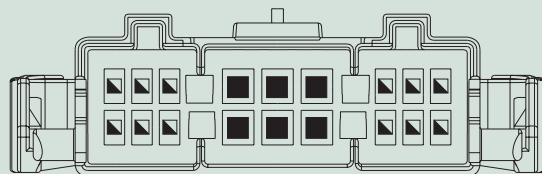
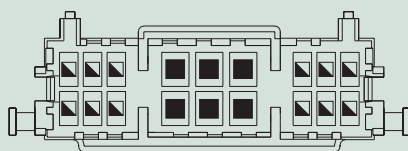

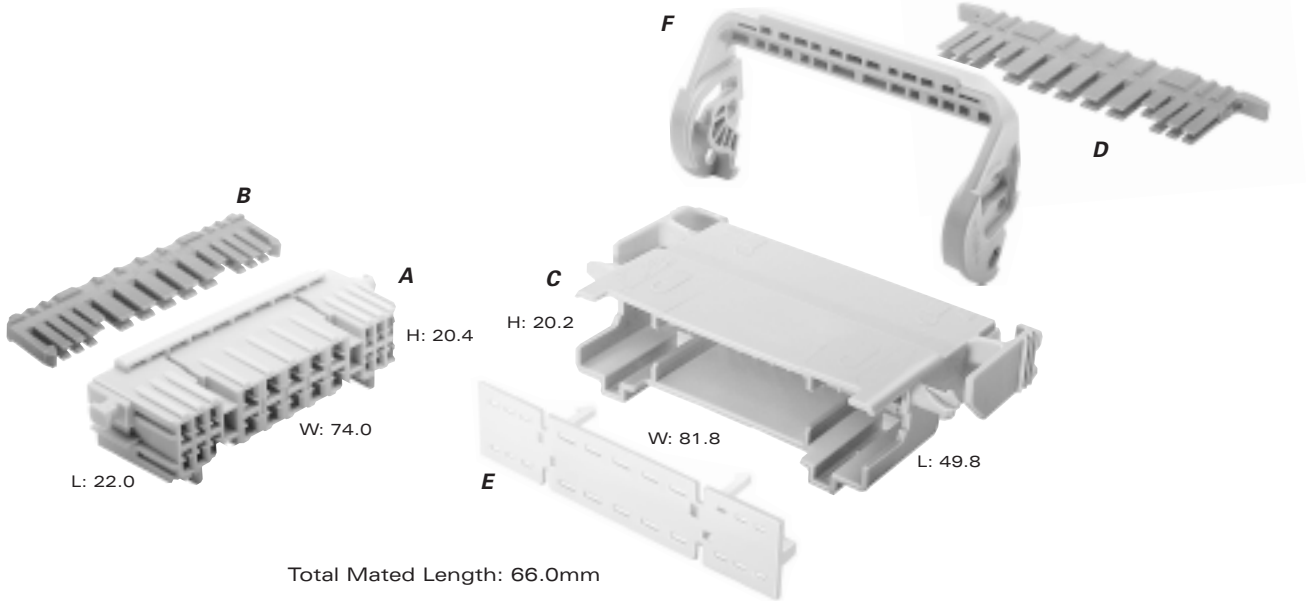

A PART NO: **15317325 (Lt. Gray)**
15326063 (Md. Gray)
 DESCRIPTION: Connector 22F
 SIZE: 22.0L x 20.4H x 74.0W
 MATERIAL: PA66 HS IM
 TERMINALS: See Page 40

B PART NO: **15317326**
 DESCRIPTION: TPA
 COLOR: Blue
 MATERIAL: PBT

C PART NO: **15317322 (Lt. Gray)**
15326064 (Md. Gray)
 DESCRIPTION: Connector 22M
 SIZE: 49.8L x 20.2H x 81.8W
 MATERIAL: PA66 HS IM
 TERMINALS: See Page 41
 CLIP: 12110290

D PART NO: **15317323**
 DESCRIPTION: TPA
 COLOR: Blue
 MATERIAL: PBT

E PART NO: **15418983**
 DESCRIPTION: Stabilizer
 COLOR: Natural
 MATERIAL: PA66 HS IM

F PART NO: **15317321**
 DESCRIPTION: Lever Lock
 COLOR: Blue
 MATERIAL: PA66 HS IM

KEY:

- ▣ 150 SERIES
- 280 SERIES

Mixed connectors feature a combination of different terminal cavities, as indicated by the key.

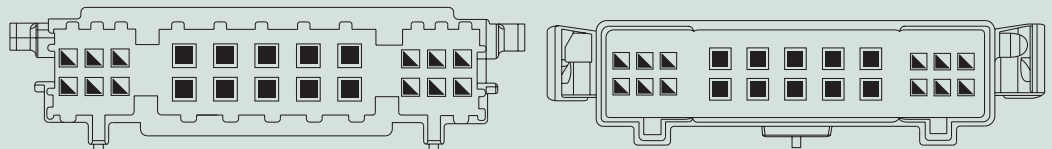

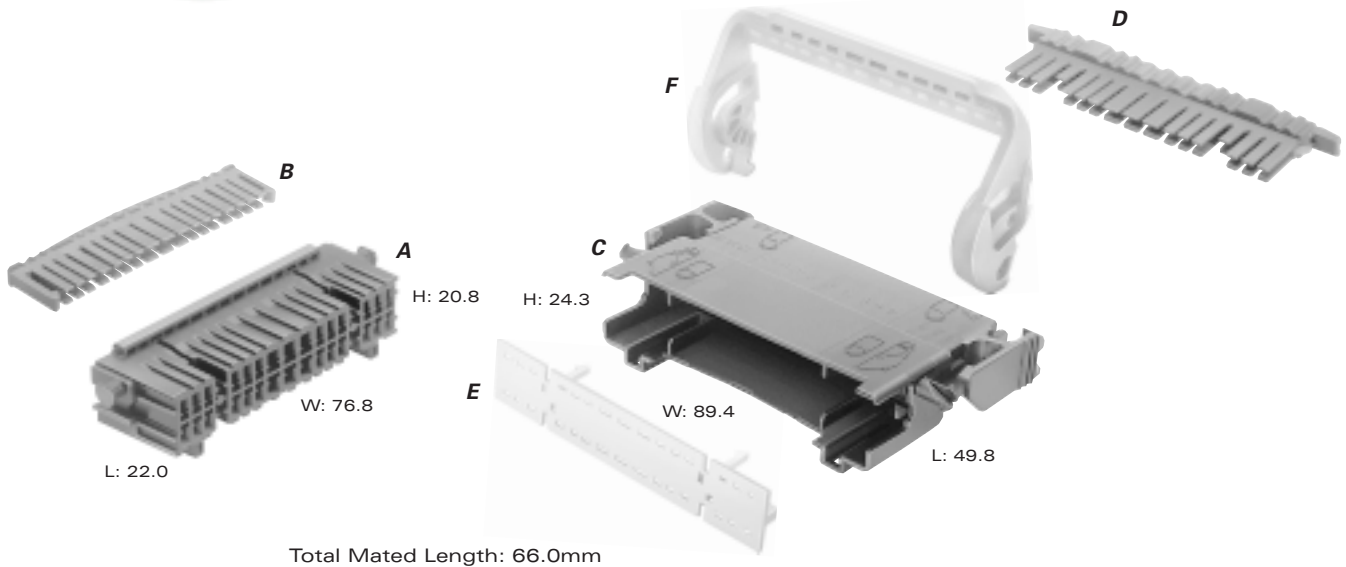

Total Mated Length: 66.0mm

A PART NO: 15304908
 DESCRIPTION: Connector 30F
 SIZE: 22.0L x 20.8H x 76.8W
 COLOR: Black
 MATERIAL: PA66 HS IM
 TERMINALS: See Page 40

C PART NO: 15326762
 DESCRIPTION: Connector 30M
 SIZE: 49.8L x 24.3H x 89.4W
 COLOR: Black
 MATERIAL: PA66 HS IM
 TERMINALS: See Page 41

B PART NO: 15304913
 DESCRIPTION: TPA
 COLOR: Blue
 MATERIAL: PBT

D PART NO: 15304912
 DESCRIPTION: TPA
 COLOR: Blue
 MATERIAL: PBT

E PART NO: 15418984
 DESCRIPTION: Stabilizer
 COLOR: Natural
 MATERIAL: PA66 HS IM

F PART NO: 15326799
 DESCRIPTION: Lever Lock
 COLOR: Natural
 MATERIAL: PA66 HS IM 14% GF

KEY:

- 150 SERIES
- 280 SERIES

Mixed connectors feature a combination of different terminal cavities, as indicated by the key.

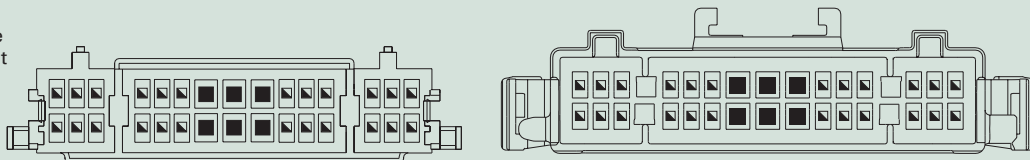

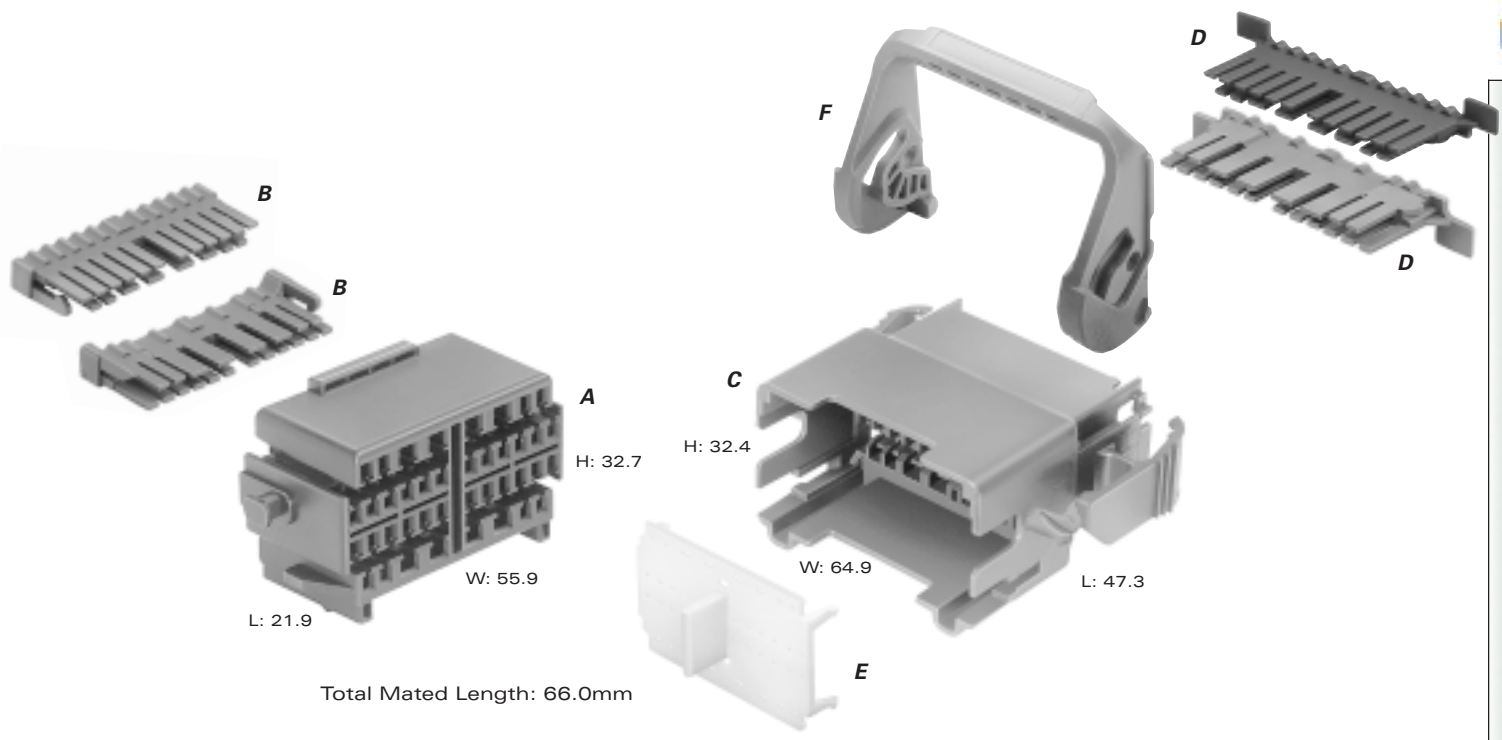

- | | |
|--|--|
| <p>A PART NO: 15359287 (Black)
15393744 (Gray)</p> <p>DESCRIPTION: Connector 40F</p> <p>SIZE: 21.9L x 32.7H x 55.9W</p> <p>MATERIAL: PA66 HS IM</p> <p>TERMINALS: See Page 40</p> | <p>C PART NO: 15336417 (Black)
15305216 (Gray)</p> <p>DESCRIPTION: Connector 40M</p> <p>SIZE: 47.3L x 32.4H x 64.9W</p> <p>MATERIAL: PA66 HS IM</p> <p>TERMINALS: See Page 41</p> |
| <p>B PART NO: 15304842</p> <p>DESCRIPTION: TPA</p> <p>NUMBER REQ.: 2</p> <p>COLOR: Blue</p> <p>MATERIAL: PBT</p> | <p>D PART NO: 15304841</p> <p>DESCRIPTION: TPA</p> <p>NUMBER REQ.: 2</p> <p>COLOR: Blue</p> <p>MATERIAL: PBT</p> |
| <p>E PART NO: 15326177</p> <p>DESCRIPTION: Stabilizer</p> <p>COLOR: Natural</p> <p>MATERIAL: PA66 HS IM</p> | |
| <p>F PART NO: 15336387</p> <p>DESCRIPTION: Lever Lock</p> <p>COLOR: Natural</p> <p>MATERIAL: PA66 HS IM 14% GF</p> | |

KEY:

- 150 SERIES
- 280 SERIES

Mixed connectors feature a combination of different terminal cavities, as indicated by the key.

<http://delphi.com/products/connect>



Cross Sectional View

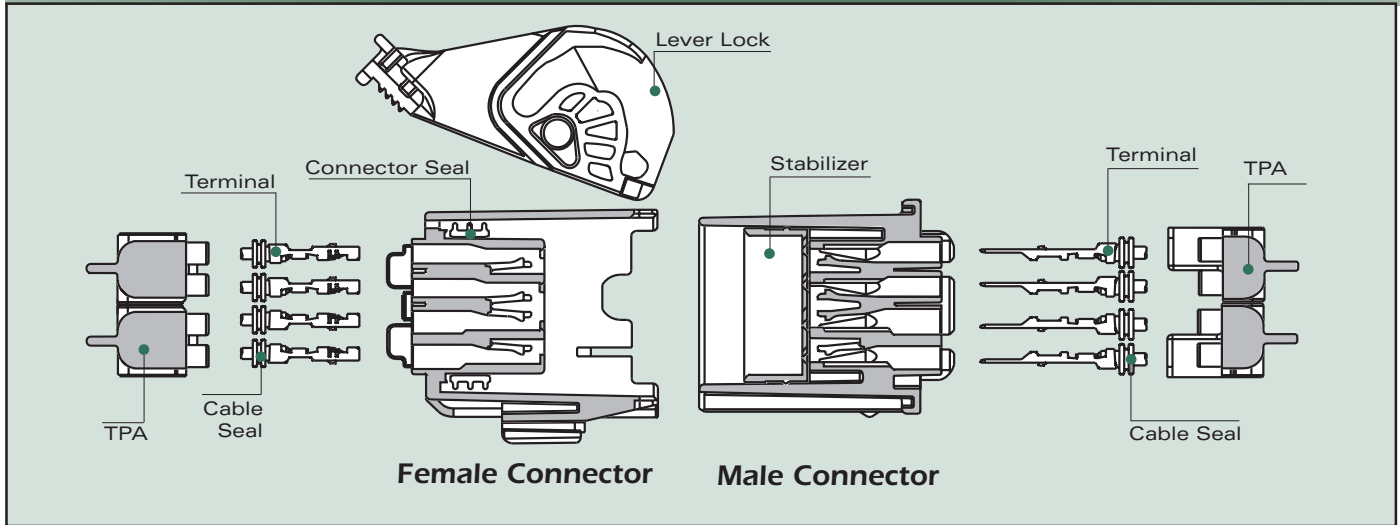

GT 150 FEMALE TERMINALS SEALED

Part #	Cable Range (mm ²)	Material	Plating
12191818	0.50-0.35	Tin Brass	Tin
12191819	1.00-0.75	Tin Brass	Tin

GT 280 FEMALE TERMINALS SEALED

Part # Dia. 5.2 (mm)	Part # Dia. 5.8 (mm)	Cable Range (mm ²)	Material	Plating
15304715	15304718	0.50-0.35	Tin Brass	Tin
15304716	15304719	1.00-0.75	Tin Brass	Tin
15304717	-	2.00-1.50	Tin Brass	Tin
-	15304720	3.00-1.50	Tin Brass	Tin
-	15326004	5.00-4.00	Beryllium Copper	Tin



GT 150 CABLE SEALS

Reel Part #	Loose Part #	Cable Diameter	Material	Color
12191152	15366021	1.20-1.85	Silicone	White
12191153	15366060	1.86-2.25	Silicone	Blue

GT 280 CABLE SEALS

	Reel Part #	Loose Part #	Cable Diameter	Material	Color
280 5.8mm	12191221	15366065	1.20-1.85	Silicone	Orange
	12191222	15366066	1.86-2.25	Silicone	Yellow
	12191223	15366067	2.50-3.20	Silicone	Tan
	-	12191235	3.40-3.90	Silicone	Purple
280 5.2mm	12191156	15366063	1.20-1.85	Silicone	Gray
	12191157	15366064	1.86-2.25	Silicone	Purple
	12191154	15366061	2.09-2.66	Silicone	Dk. Red

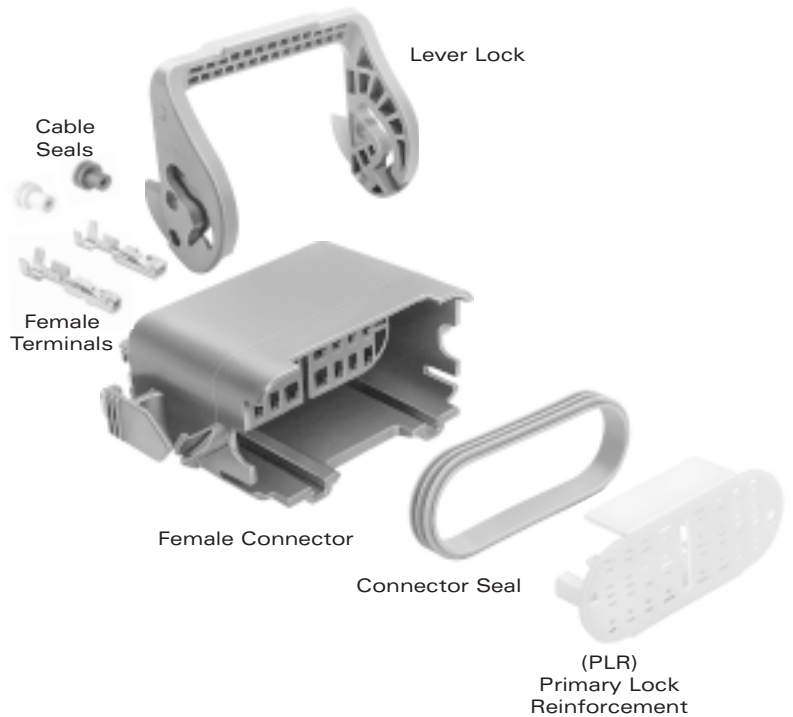

GT FEMALE LEVER LOCK CONNECTORS SEALED

# Cavities	Connector	Color	Material	PLR	TPA	Seal		Lever Lock
						Seal	Lever Lock	
24	15366099	Black	PA6 10%GF & 20% GB	15373422	-	15336177	15369322	
38	15336418	Black	PA66 HS IM	-	15304904	15304905	15336267	



Sealed System Application Information

GT 150 SERIES TERMINALS-Tin Plated

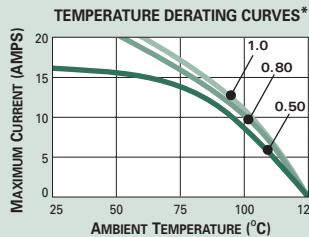
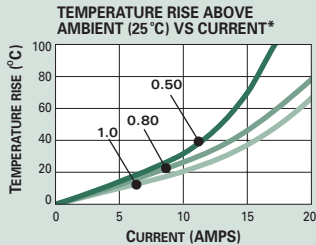

CABLE RANGE (mm²): 0.35-1.0
 CURRENT RANGE (AMPS): 0-15
 TEMP RANGE °C: -40 to 125
 RESISTANCE: <10mΩ@20mV

VOLTAGE DROP: <10.0mV/amp
 CENTERLINE SPACING (mm): 4.5
 BLADE WIDTH (mm): 1.5

280 SERIES TERMINALS - Tin Plated

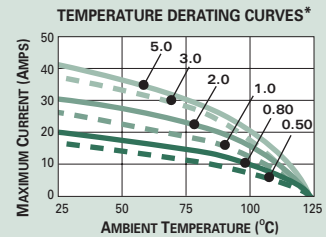
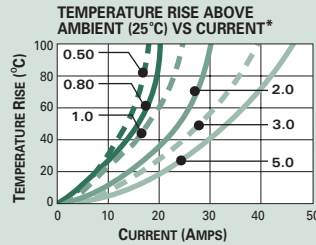

CABLE RANGE (mm²): 0.35-5.0
 CURRENT RANGE (AMPS): 0-25
 TEMP RANGE °C: -40 to 125
 RESISTANCE: <10mΩ@20mV

VOLTAGE DROP: <4.0mV/amp
 CENTERLINE SPACING (mm): 6.5
 BLADE WIDTH (mm): 2.8

* The test data are based on single circuits in free space and were generated using a "Lumped Resistance" model. This model does not account for all of the variables that would be present in an actual application. For actual product performance, contact your regional support representative at the number listed below.

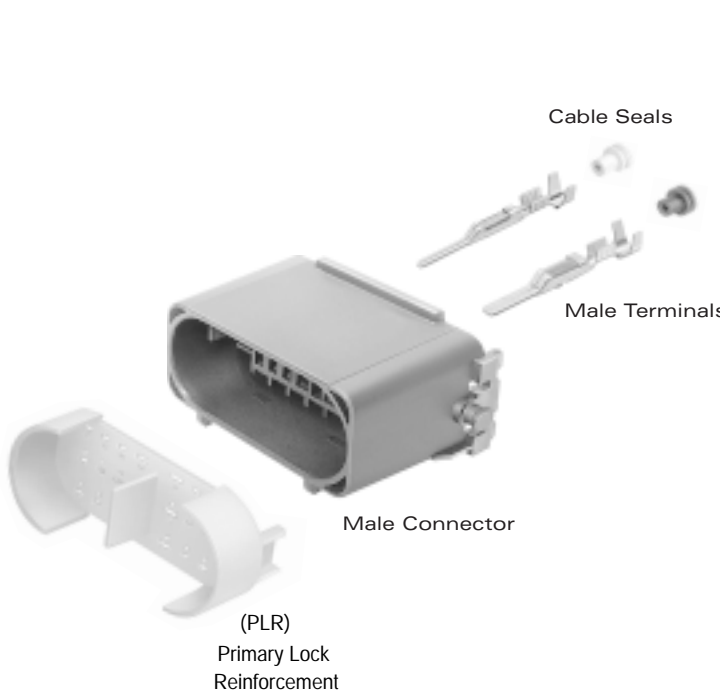

GT 150 MALE TERMINALS SEALED

Part #	Cable Range (mm ²)	Material	Plating
15326268	0.50-0.35	Tin Brass	Tin
15326269	1.00-0.75	Tin Brass	Tin

GT 280 MALE TERMINALS SEALED

Part #	Part #	Cable Range (mm ²)	Material	Plating
Dia. 5.2 (mm)	Dia. 5.8 (mm)			
15304727	15304730	0.50-0.35	Tin Brass	Tin
15304728	15304731	1.00-0.75	Tin Brass	Tin
-	15304732	3.00-1.50	Tin Brass	Tin
15304729	-	2.00-1.50	Tin Brass	Tin

GT 150 CAVITY PLUG*

Part #	Cavity Diameter	Material	Color
15305171	4.0mm	Silicone	Green

*Cavity plugs seal unused female and male cavities.

GT 280 CAVITY PLUG*

Part #	Cavity Diameter	Material	Color
12059168	5.2mm	Silicone	Dk. Red
15305170	5.8mm	Silicone	White

*Cavity plugs seal unused female and male cavities.

GT MALE LEVER LOCK CONNECTORS SEALED

# Cavities	Connector	Color	Material	PLR	TPA	Stabilizer
24	15336173	Black	PA66 HS IM 14% GF	15355131	-	-
38	15317380	Black	PA66 HS IM	-	15304903	15304902

SECTION NOTES:

- Contact your regional support representative at the number listed below.
- Due to rigid tolerances of connector cavities, it is critical to meet all crimp dimension as specified.

<http://delphi.com/products/connect>

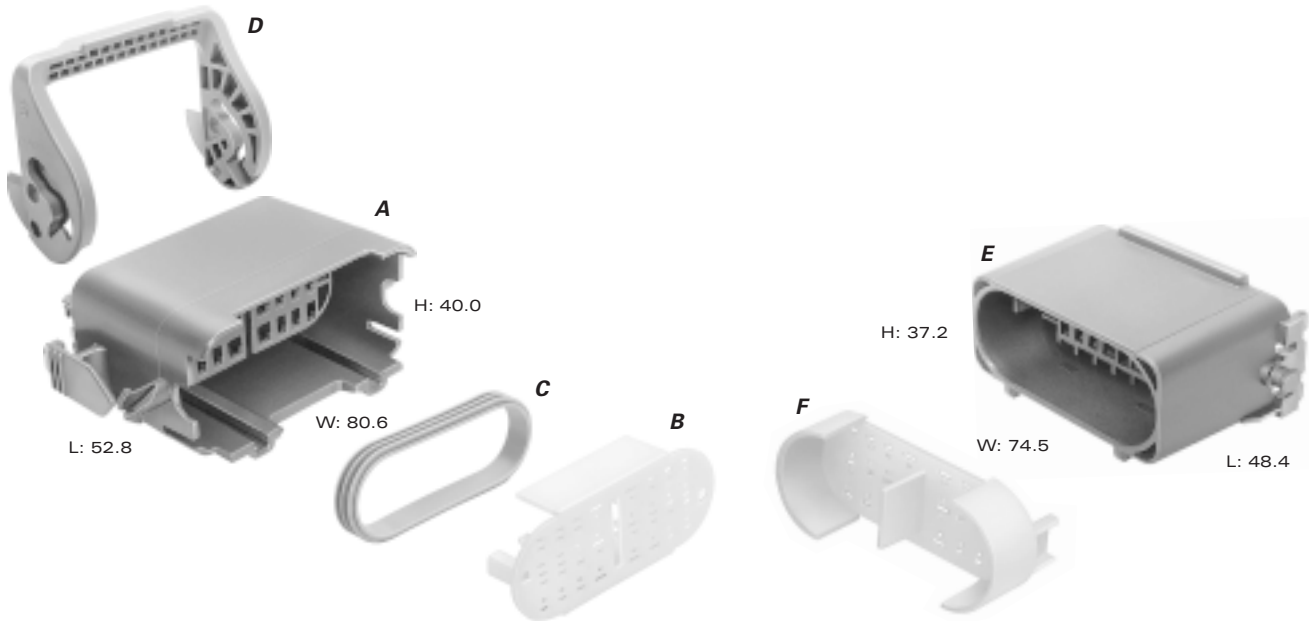

Total Mated Length: 72.0mm

A PART NO: 15366099
 DESCRIPTION: Connector 24F
 SIZE: 52.8L x 40.0H x 80.6W
 COLOR: Black
 MATERIAL: PA6 10%GF & 20% GB
 TERMINALS: See Page 46
 SEALS/PLUGS: See Page 46, 47

E PART NO: 15336173
 DESCRIPTION: Connector 24M
 SIZE: 48.4L x 37.2H x 74.5W
 COLOR: Black
 MATERIAL: PA66 HS IM 14% GF
 TERMINALS: See Page 47
 SEALS/PLUGS: See Page 46, 47

B PART NO: 15373422
 DESCRIPTION: PLR
 COLOR: Natural
 MATERIAL: PA66 HS IM

F PART NO: 15373421
 DESCRIPTION: PLR
 COLOR: Md. Gray
 MATERIAL: PA66 HS IM

C PART NO: 15336177
 DESCRIPTION: Connector Seal
 COLOR: Green
 MATERIAL: Silicone

D PART NO: 15369322
 DESCRIPTION: Lever Lock
 COLOR: Md. Gray
 MATERIAL: PA66 HS IM

KEY:

- ▣ 150 SERIES
- 280 SERIES

Mixed connectors feature a combination of different terminal cavities, as indicated by the key.

System Note:
 For 280 Series sealed cavities use 5.8mm cavity diameter terminals and seals from pages 46 and 47.

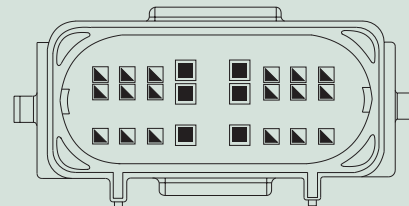
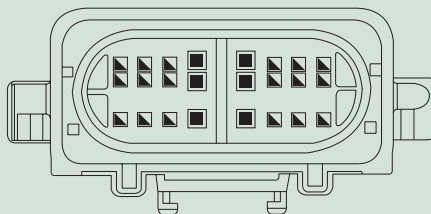

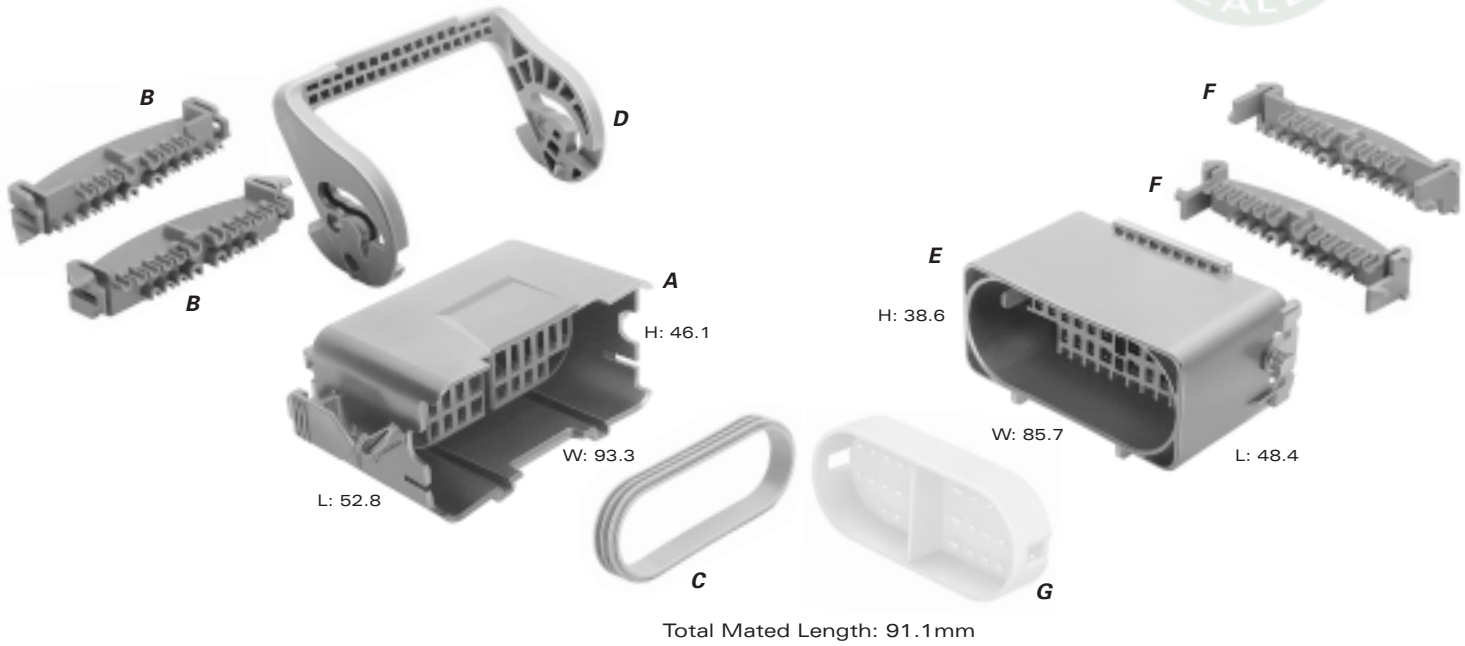

A PART NO: 15336418
 DESCRIPTION: Connector 38F
 SIZE: 52.8L x 46.1H x 93.3W
 COLOR: Black
 MATERIAL: PA66 HS IM
 TERMINALS: See Page 46
 SEALS/PLUGS: See Page 46, 47

B PART NO: 15304904
 DESCRIPTION: TPA
 NUMBER REQ.: 2
 COLOR: Lt. Gray
 MATERIAL: PBT

C PART NO: 15304905
 DESCRIPTION: Connector Seal
 COLOR: Green
 MATERIAL: Silicone

D PART NO: 15336267
 DESCRIPTION: Lever Lock
 COLOR: Dk. Gray
 MATERIAL: PA66 HS IM 14% GF

E PART NO: 15317380
 DESCRIPTION: Connector 38M
 SIZE: 48.4L x 38.6H x 85.7W
 COLOR: Black
 MATERIAL: PA66 HS IM
 TERMINALS: See Page 47
 SEALS/PLUGS: See Page 46, 47
 CLIP: 12084149

F PART NO: 15304903
 DESCRIPTION: TPA
 NUMBER REQ.: 2
 COLOR: Lt. Gray
 MATERIAL: PBT

G PART NO: 15304902
 DESCRIPTION: Stabilizer
 COLOR: Natural
 MATERIAL: PA66 HS IM

KEY:

- ▣ 150 SERIES
- 280 SERIES
- ⊗ Blocked Cavity

Mixed connectors feature a combination of different terminal cavities, as indicated by the key.

System Note:
 For 280 Series sealed cavities use 5.2mm cavity diameter terminals and seals from pages 46 and 47.

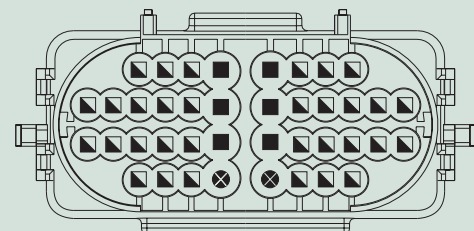
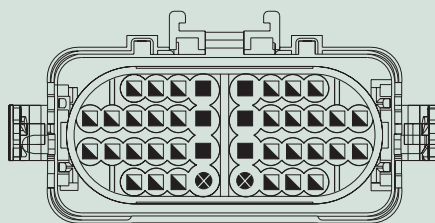

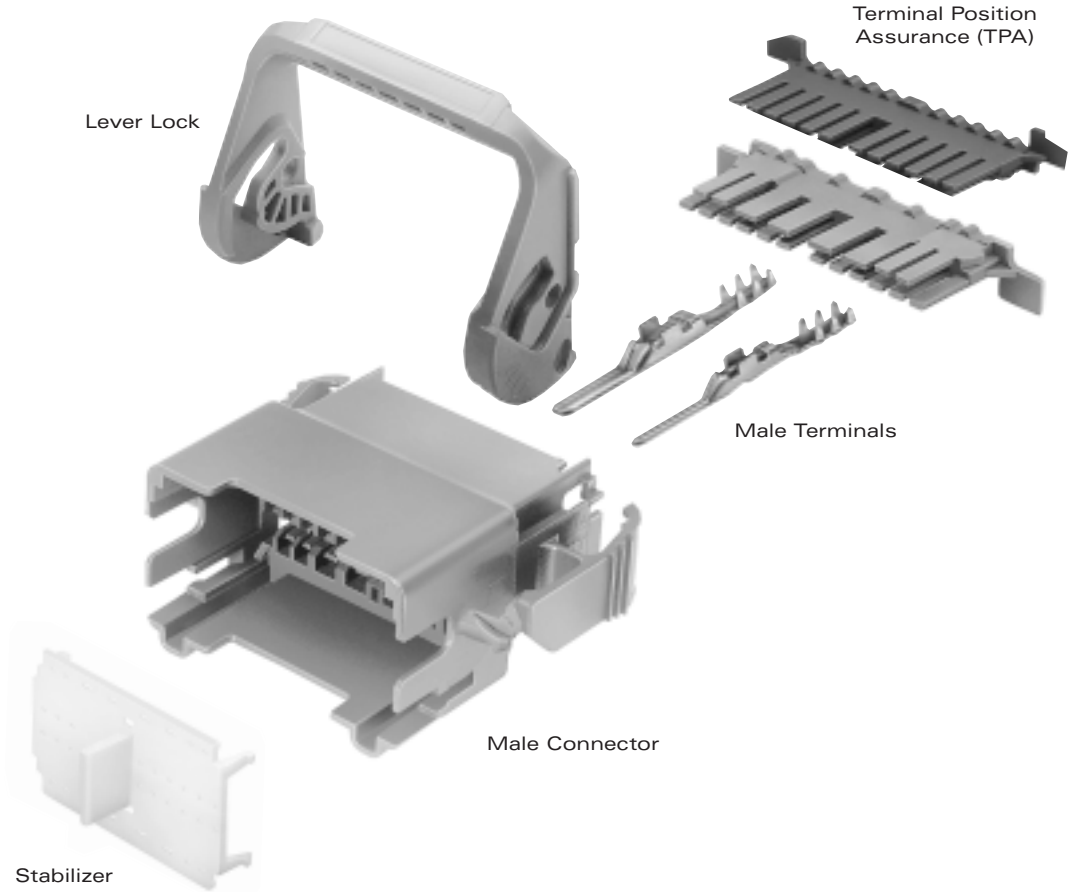

GT MALE LEVER LOCK CONNECTORS UNSEALED

# Cavities	Connector	Color	Material	TPA	Stabilizer	Lever Lock
30	15317735	Brown	PA66 HS IM	15317828	15418984	15326799
40	15317694	Brown	PA66 HS IM	15355380	15326177	15336387

GT 150 MALE TERMINALS UNSEALED

Part #	Material	Plating
15317814	Tin Brass	Tin

GT 280 MALE TERMINALS UNSEALED

Part #	Material	Plating
15317815	Tin Brass	Tin

SECTION NOTES:

- Contact your regional support representative at the number listed below.
- Flex Circuit Systems mate to conventional female connection systems.

<http://delphi.com/products/connect>

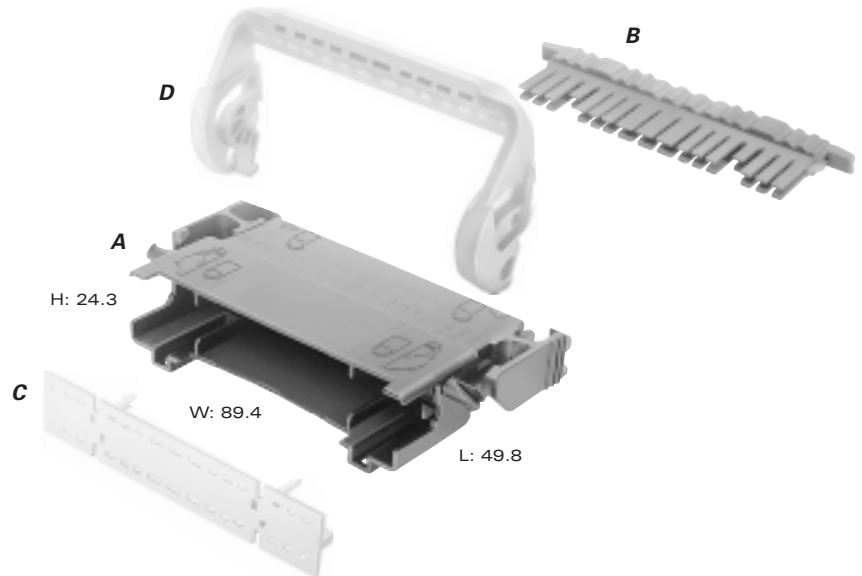

SYSTEM NOTES:

- Conventional mating connector
15305216 (Female) Brown
- 15304913 (TPA) Blue
- Terminals See Page 40.

A PART NO: 15317735
 DESCRIPTION: Connector 30M
 SIZE: 49.8L x 24.3H x 89.4W
 COLOR: Brown
 MATERIAL: PA66 HS IM
 TERMINALS: See Page 50

B PART NO: 15317828
 DESCRIPTION: TPA
 COLOR: Green
 MATERIAL: PBT

C PART NO: 15418984
 DESCRIPTION: Stabilizer
 COLOR: Natural
 MATERIAL: PA66 HS IM

D PART NO: 15326799
 DESCRIPTION: Lever Lock
 COLOR: Natural
 MATERIAL: PA66 HS IM 14% GF

KEY:

- 150 SERIES
- 280 SERIES

Mixed connectors feature a combination of different terminal cavities, as indicated by the key.

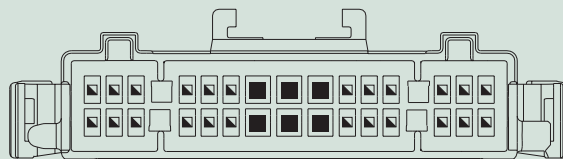

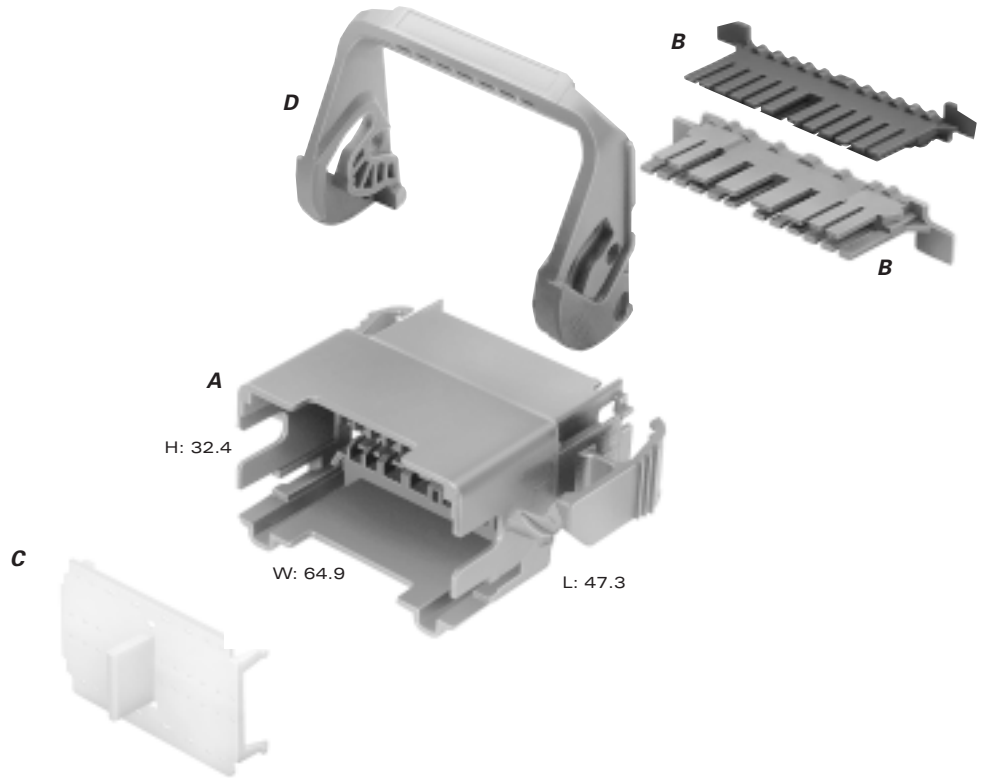

SYSTEM NOTES:

- Conventional mating connector 15305218 (Female) Brown
15304342 (TPA) Blue
- Terminals See Page 40.

A PART NO: 15317694
 DESCRIPTION: Connector 40M
 SIZE: 47.3L x 32.4H x 64.9W
 COLOR: Brown
 MATERIAL: PA66 HS IM
 TERMINALS: See Page 50

B PART NO: 15355380
 DESCRIPTION: TPA
 NUMBER REQ.: 2
 COLOR: Green
 MATERIAL: PBT HM IS

C PART NO: 15326177
 DESCRIPTION: Stabilizer
 COLOR: Natural
 MATERIAL: PA66 HS IM

D PART NO: 15336387
 DESCRIPTION: Lever Lock
 COLOR: Natural
 MATERIAL: PA66 HS IM 14% GF

KEY:

- 150 SERIES
- 280 SERIES

Mixed connectors feature a combination of different terminal cavities, as indicated by the key.

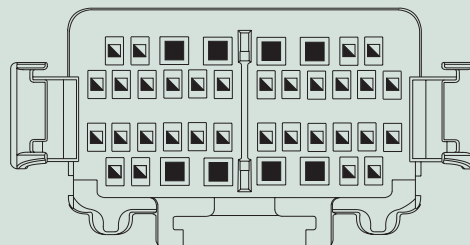

Part Number Index



Part#	Page	Part#	Page	Part#	Page	Part#	Page
15332129	10,9	15326840	15,14	12162218	16	15326614	26,25
15332132	10,9	15326847	15,14	12162186	16	15326631	26,25
15332135	10,9	15326854	15,14	12162204	16	15326635	26,25
15332138	10,9	15326861	15,14	12162206	16	15326642	26,25
15332141	10,9	15326868	15,14	12162208	16	15326679	26,25
15332145	10,10	15326268	15,37,44	12162210	17	15326654	26,26
15332153	10,10	15326269	15,37,44	12162260	17	15326660	26,26
15332161	10,10	15305171	15,37,44	12162261	17	15326666	26,26
15332169	10,10	15336024	18,16	12066317	17	15326910	26,26
15332177	10,10	15336027	18,16	12162262	17	15326917	26,26
12191811	10,32,37	15336029	18,16	12162286	17	12191221	26,36,43
12191812	10,32,37	15354716	18,16	12162825	17	12191222	26,36,43
15332130	11,9	12191155	15	12162826	17	12191223	26,36,43
15332133	11,9	15326266	15	12162827	17	12191235	26,36,43
15332136	11,9	15305350	15	12162197	18	15304718	26,36,43
15332139	11,9	15305351	15	12162198	18	15304719	26,36,43
15332142	11,9	15366022	15	12162199	18	15304720	26,36,43
15332150	11,10	15305169	15	12162279	18	15326004	26,36,43
15332158	11,10	12162182	19,17	12162280	18	15366065	26,36,43
15332166	11,10	12162185	19,17	12162278	18	15366066	26,36,43
15332174	11,10	12162188	19,17	12162833	18	15366067	26,36,43
15332182	11,10	12162189	19,17	12162834	18	15326623	27,25
15304701	11,33,38	12162190	19,17	15326870	22,21	15326633	27,25
15304702	11,33,38	12162191	19,17	15326877	22,21	15326640	27,25
15317832	12,13,16,17,20, 21,24,25,28,29, 34,35	12162193	19,17	15326886	22,21	15326647	27,25
		12162194	19,17	15326893	22,21	15326678	27,25
		12162195	19,17	15326900	22,21	15326655	27,26
15326829	14,16,17	15336004	19,17	15326110	22,22	15326661	27,26
15326801	14,13	12124846	19,17	15326924	22,22	15326667	27,26
15326808	14,13	12129192	19,17	15326931	22,22	15326915	27,26
15326815	14,13	12162183	19,17	15326952	22,22	15326922	27,26
15326822	14,13	12162184	19,17	15304710	22,32,37	15304730	27,37,44
15326835	14,14	15326389	19,17	15304711	22,32,37	15304731	27,37,44
15326842	14,14	15355331	19,17	15304712	22,32,37	15304732	27,37,44
15326849	14,14	15336013	19,17	15304713	22,32,37	15305170	27,37,44
15326856	14,14	15336121	19,17	15326874	23,21	15336116	27
15326863	14,14	15355317	19,17	15326881	23,21	15336117	27
12191152	14,36,43	15355323	19,17	15326890	23,21	15326082	32,31
12191153	14,36,43	15355331	19,17	15326897	23,21	15336205	32,31
12191818	14,36,43	15335987	19,18	15326904	23,21	15336219	32,31
12191819	14,36,43	15326556	19,18	15326928	23,22	15336209	33,31
15366021	14,36,43	15336001	19,18	15326935	23,22	15336224	33,31
15366060	14,36,43	15355319	19,18	15326942	23,22	15326084	36,35
15326806	15,13	15355325	19,18	15326956	23,22	15326939	36,35
15326813	15,13	15355329	19,18	15304722	23,33,38	15336037	36,35
15326820	15,13	12162215	16	15304723	23,33,38	15326085	37,35
15326827	15,13	12162216	16	15304724	23,33,38	15336034	37,35
15326833	15,13	12162217	16	15304725	23,33,38	15422562	37,35

<http://delphi.com/products/connect>

Part#	Page	Part#	Page
15304692	40,39	15373421	47,45
15304694	40,39	15304902	47,46
15317325	40,40	15304903	47,46
15317326	40,40	15317380	47,46
15304908	40,41	12059168	44
15304913	40,41	15304727	44
15359287	40,42	15304728	44
15304842	40,42	15304729	44
15418982	41,39	15317735	50,48
15304695	41,39	15317828	50,48
15317550	41,39	15317694	50,49
15336468	41,39	15355380	50,49
15317321	41,40	15317814	47
15317322	41,40	15317815	47
15317323	41,40		
15418983	41,40		
15418984	41,44,50,48		
15326799	41,44,50,48		
15304912	41,41		
15326762	41,41		
15326177	41,45,50,49		
15336387	41,45,50,49		
15304841	41,42		
15336417	41,42		
15304690	39		
15336467	39		
15326063	40		
15326064	40		
15305216	42		
15393744	42		
15336177	46,45		
15373422	46,45		
15366099	46,45		
15369322	46,45		
15304904	46,46		
15304905	46,46		
15336267	46,46		
15336418	46,46		
12191154	43		
12191156	43		
12191557	43		
15304715	43		
15304716	43		
15304717	43		
15366061	43		
15366063	43		
15366064	43		
15336173	47,45		



X-ON Electronics

Largest Supplier of Electrical and Electronic Components

Click to view similar products for [Automotive Connectors](#) category:

Click to view products by [Delphi](#) manufacturer:

Other Similar products are found below :

[003-018-000](#) [600858](#) [60403001](#) [60993906-B](#) [60993913-B](#) [629515004020001](#) [M902-2131](#) [M902-2161](#) [M902-2344](#) [72.330.1035.1](#)
[73.353.4028.0](#) [F118010](#) [F119300-B](#) [F132210](#) [F132210-B](#) [F166900](#) [F180100](#) [F258300](#) [F258300-B](#) [F294300-B](#) [F339100](#) [F339700](#) [F358300-](#)
[B](#) [F374110](#) [F407400](#) [F412210](#) [F427600](#) [F444110](#) [F487000](#) [F495100-B](#) [F500900-B](#) [F509500B-B](#) [770444-1](#) [776880-1](#) [827153-1](#) [881735-1](#)
[8N1515-32-24P](#) [9-1326727-8](#) [9-1326729-8](#) [925467-1](#) [925474-1](#) [928905-1](#) [936398-2](#) [964562-1](#) [964562-4](#) [964731-2](#) [965051-1](#) [968782-1](#)
[GT17SA-8DS-HU](#) [GT17VS-10DP-5.2CF](#)