

Inductors for power circuits
Wound ferrite
VLCF series



VLCF4024-2 type



FEATURES

- Magnetic shield type wound inductor for power circuits.
- Low-profile product.
- Magnetic shield construction with ferrite core.
- Operating temperature range: -40 to +105°C (including self-temperature rise)

APPLICATION

- Power source inductor for mobile devices such as HDDs, DVCs, and DSCs
- LCDs, other DC to DC converters

PART NUMBER CONSTRUCTION

| | | | | | | | | |
|-------------|------------------------------------|-----------------|---|--------------------------|-------------------------|----------------------|---|---------------|
| VLCF | 4024 | T | - | 1R2 | N | 2R4 | - | 2 |
| Series name | LxWxH dimensions 4.0x4.0x2.4 mm | Packaging style | | Inductance (μ H) | Inductance tolerance | Rated current (A) | | Internal code |

CHARACTERISTICS SPECIFICATION TABLE

| L (μ H) | Measuring frequency (kHz) | DC resistance (Ω)max. (Ω)typ. | Rated current* | | Part No. |
|-----------------|---------------------------------|---|-----------------|------------------|-------------------------------------|
| | | | Isat (A)max. | Itemp (A)typ. | |
| 1.2 | 100 | 0.032 | 2.46 | 3.09 | VLCF4024T-1R2N2R4-2 |
| 1.6 | 100 | 0.039 | 2.10 | 2.61 | VLCF4024T-1R6N2R1-2 |
| 2.2 | 100 | 0.043 | 1.76 | 2.43 | VLCF4024T-2R2N1R7-2 |
| 3.3 | 100 | 0.068 | 1.60 | 1.96 | VLCF4024T-3R3N1R6-2 |
| 4.7 | 100 | 0.087 | 1.43 | 1.76 | VLCF4024T-4R7N1R4-2 |
| 6.8 | 100 | 0.116 | 1.15 | 1.54 | VLCF4024T-6R8N1R1-2 |
| 10 | 100 | 0.136 | 0.90 | 1.37 | VLCF4024T-100MR90-2 |
| 15 | 100 | 0.198 | 0.80 | 1.05 | VLCF4024T-150MR80-2 |
| 22 | 100 | 0.332 | 0.65 | 0.90 | VLCF4024T-220MR65-2 |
| 33 | 100 | 0.438 | 0.55 | 0.74 | VLCF4024T-330MR55-2 |
| 47 | 100 | 0.644 | 0.44 | 0.64 | VLCF4024T-470MR44-2 |
| 100 | 100 | 1.21 | 0.30 | 0.48 | VLCF4024T-101MR30-2 |

* Rated current: smaller value of either Isat or Itemp.

Isat: When based on the inductance change rate (30% below the initial value)

Itemp: When based on the temperature increase (temperature increase of 40°C by self heating)

Measurement equipment

| Measurement item | Product No. | Manufacturer |
|--------------------|---------------------|-----------------------|
| L | 4194A | Keysight Technologies |
| DC resistance | VP-2941A | Panasonic |
| Rated current Isat | 4285A+42841A+42842C | Keysight Technologies |

* Equivalent measurement equipment may be used.



VLCF4024-2 type

L FREQUENCY CHARACTERISTICS

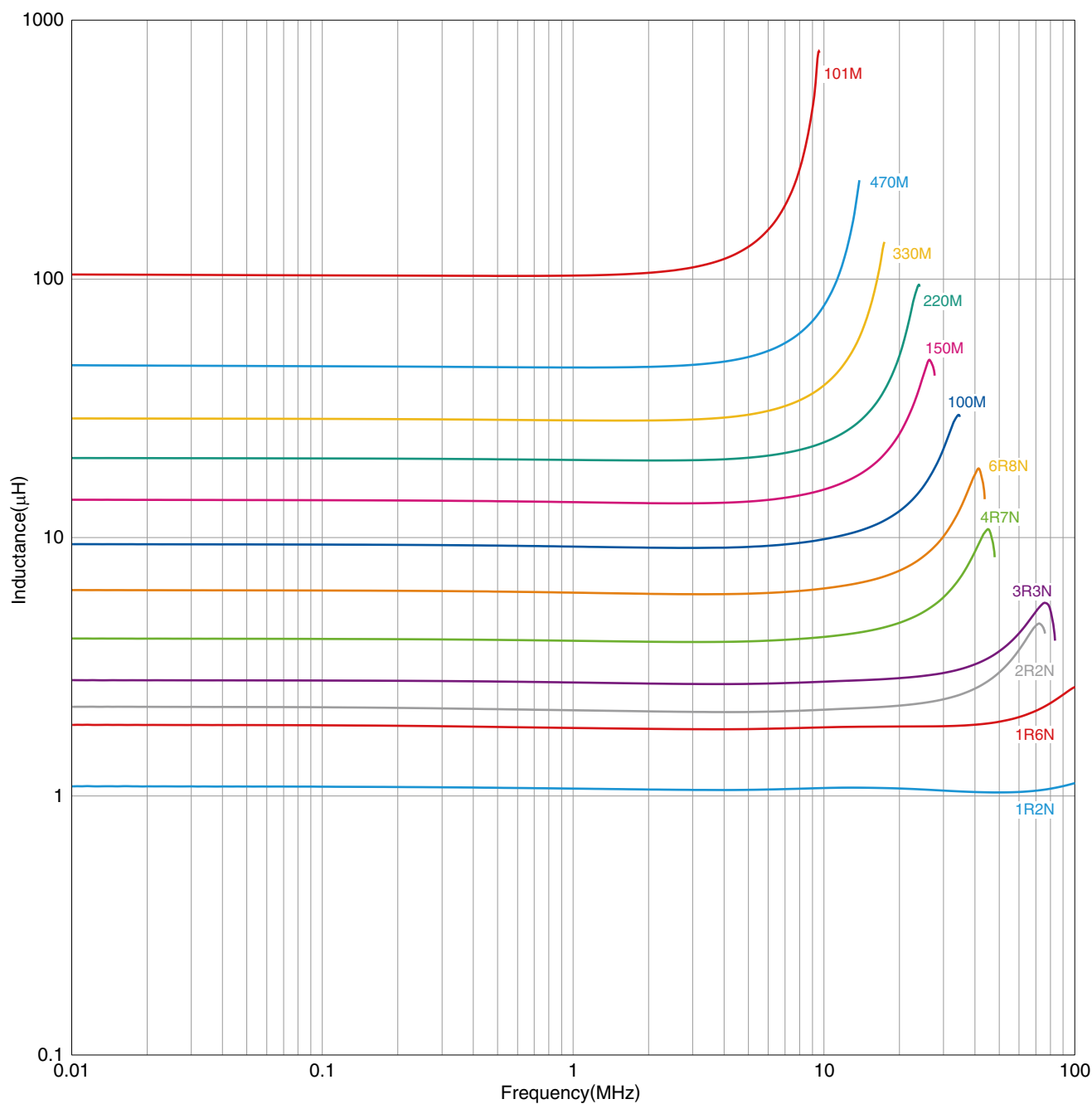

Measurement equipment

| Product No. | Manufacturer |
|-------------|-----------------------|
| 4294A | Keysight Technologies |

* Equivalent measurement equipment may be used.

VLCF4024-2 type

INDUCTANCE VS. DC BIAS CHARACTERISTICS

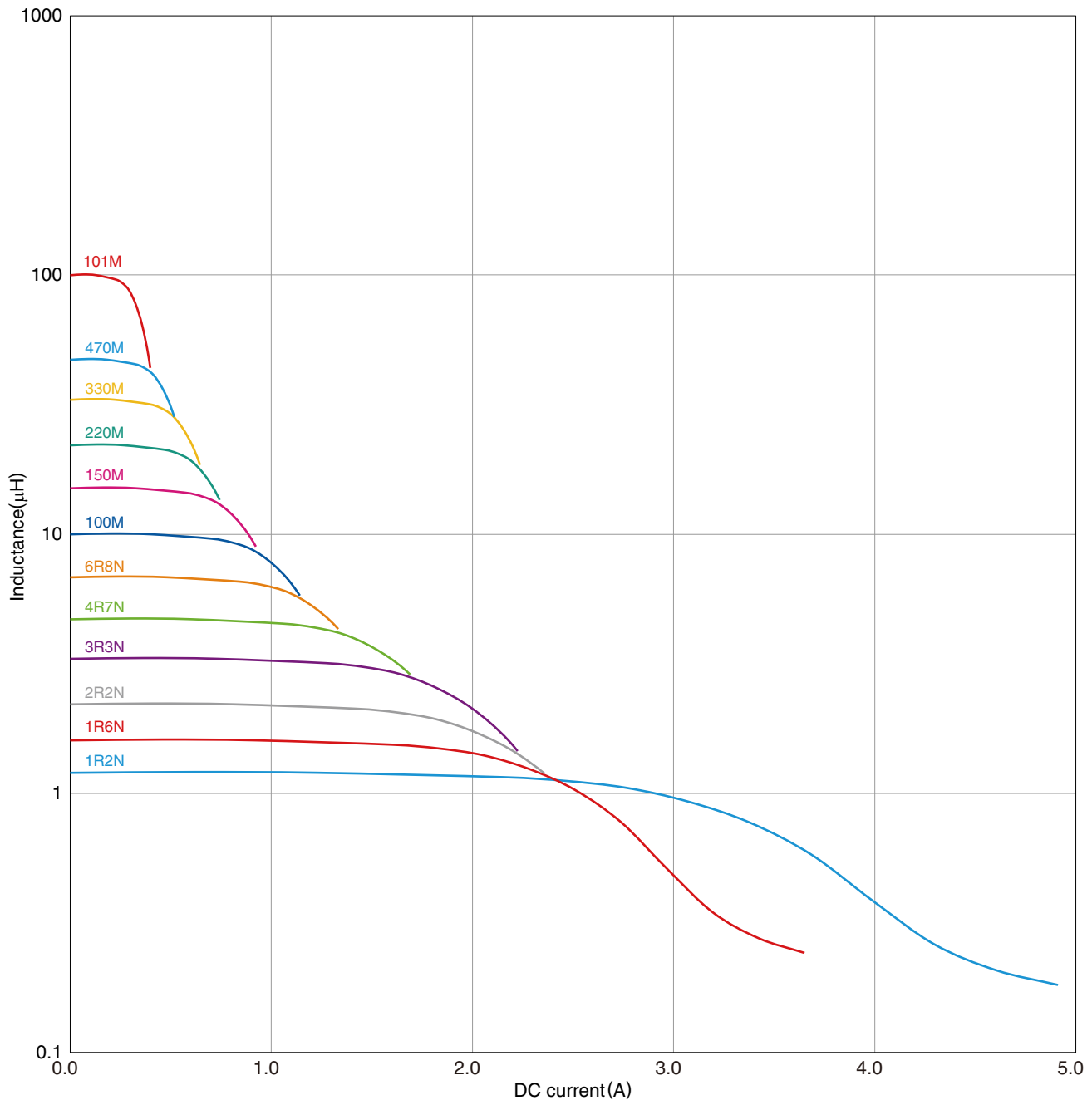

Measurement equipment

| Product No. | Manufacturer |
|---------------------|-----------------------|
| 4285A+42841A+42842C | Keysight Technologies |

* Equivalent measurement equipment may be used.

VLCF4024-2 type

SHAPE & DIMENSIONS

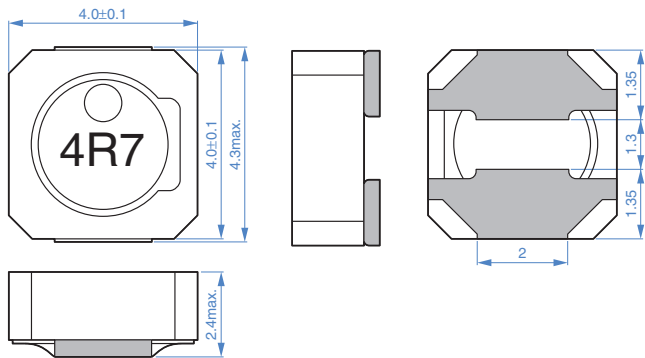

Dimensions in mm

PACKAGING STYLE

REEL DIMENSIONS

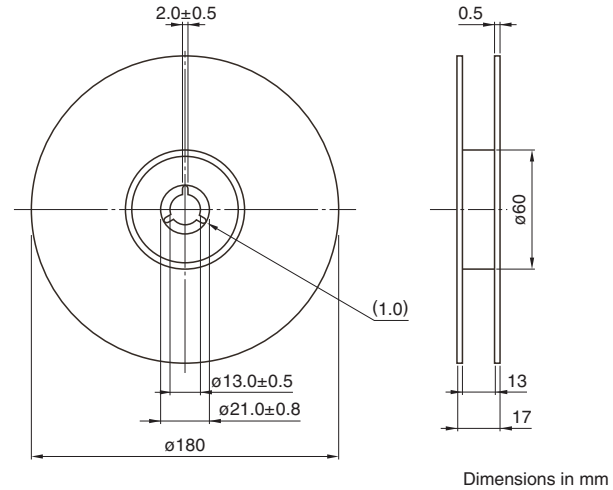

Dimensions in mm

RECOMMENDED LAND PATTERN

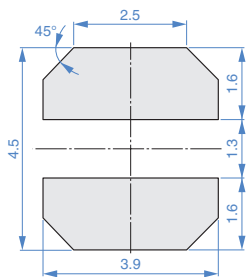

Dimensions in mm

TAPE DIMENSIONS

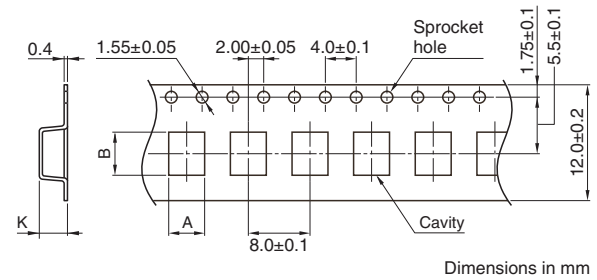

Dimensions in mm

| Type | A | B | K |
|------------|-----|-----|---|
| VLCF4024-2 | 4.4 | 4.4 | 3 |

RECOMMENDED REFLOW PROFILE

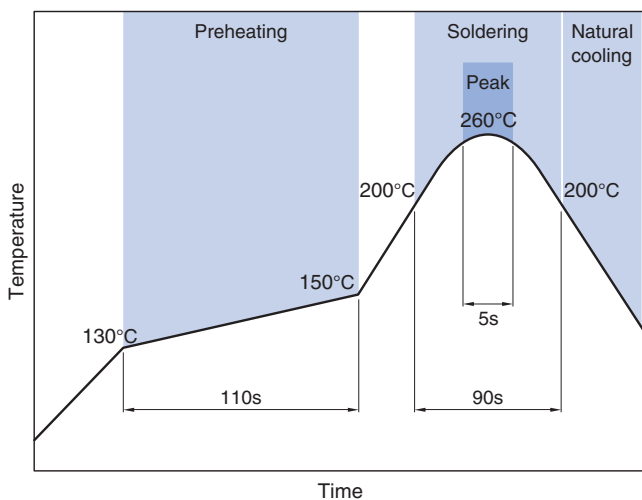

PACKAGE QUANTITY

| | |
|------------------|--------------|
| Package quantity | 500 pcs/reel |
|------------------|--------------|

TEMPERATURE RANGE, INDIVIDUAL WEIGHT

| Operating temperature range* | Storage temperature range** | Individual weight |
|------------------------------|-----------------------------|-------------------|
| -40 to 105 °C | -40 to 105 °C | 138 mg |

* Operating temperature range includes self-temperature rise.

** The storage temperature range is for after the assembly.

REMINDERS FOR USING THESE PRODUCTS

Before using these products, be sure to request the delivery specifications.

SAFETY REMINDERS

Please pay sufficient attention to the warnings for safe designing when using this products.

REMINDERS

- The storage period is less than 6 months. Be sure to follow the storage conditions (temperature: 5 to 40°C, humidity: 10 to 75% RH or less).
If the storage period elapses, the soldering of the terminal electrodes may deteriorate.
- Do not use or store in locations where there are conditions such as gas corrosion (salt, acid, alkali, etc.).
- Before soldering, be sure to preheat components.
The preheating temperature should be set so that the temperature difference between the solder temperature and chip temperature does not exceed 150°C.
- Soldering corrections after mounting should be within the range of the conditions determined in the specifications.
If overheated, a short circuit, performance deterioration, or lifespan shortening may occur.
- When embedding a printed circuit board where a chip is mounted to a set, be sure that residual stress is not given to the chip due to the overall distortion of the printed circuit board and partial distortion such as at screw tightening portions.
- Self heating (temperature increase) occurs when the power is turned ON, so the tolerance should be sufficient for the set thermal design.
- Carefully lay out the coil for the circuit board design of the non-magnetic shield type.
A malfunction may occur due to magnetic interference.
- Use a wrist band to discharge static electricity in your body through the grounding wire.
- Do not expose the products to magnets or magnetic fields.
- Do not use for a purpose outside of the contents regulated in the delivery specifications.
- The products listed on this catalog are intended for use in general electronic equipment (AV equipment, telecommunications equipment, home appliances, amusement equipment, computer equipment, personal equipment, office equipment, measurement equipment, industrial robots) under a normal operation and use condition.
The products are not designed or warranted to meet the requirements of the applications listed below, whose performance and/or quality require a more stringent level of safety or reliability, or whose failure, malfunction or trouble could cause serious damage to society, person or property.
If you intend to use the products in the applications listed below or if you have special requirements exceeding the range or conditions set forth in the each catalog, please contact us.

- (1) Aerospace/aviation equipment
- (2) Transportation equipment (cars, electric trains, ships, etc.)
- (3) Medical equipment
- (4) Power-generation control equipment
- (5) Atomic energy-related equipment
- (6) Seabed equipment
- (7) Transportation control equipment

- (8) Public information-processing equipment
- (9) Military equipment
- (10) Electric heating apparatus, burning equipment
- (11) Disaster prevention/crime prevention equipment
- (12) Safety equipment
- (13) Other applications that are not considered general-purpose applications

When designing your equipment even for general-purpose applications, you are kindly requested to take into consideration securing protection circuit/device or providing backup circuits in your equipment.

X-ON Electronics

Largest Supplier of Electrical and Electronic Components

Click to view similar products for [Fixed Inductors](#) category:

Click to view products by [TDK](#) manufacturer:

Other Similar products are found below :

[MLZ1608M6R8WTD25](#) [MLZ1608N6R8LT000](#) [MLZ1608N3R3LTD25](#) [MLZ1608N3R3LT000](#) [MLZ1608N150LT000](#)

[MLZ1608M150WTD25](#) [MLZ1608M3R3WTD25](#) [MLZ1608M3R3WT000](#) [MLZ1608M150WT000](#) [MLZ1608A1R5WT000](#)

[MLZ1608N1R5LT000](#) [B82432C1333K000](#) [PCMB053T-1R0MS](#) [PCMB053T-1R5MS](#) [PCMB104T-1R5MS](#) [CR32NP-100KC](#) [CR32NP-](#)

[151KC](#) [CR32NP-180KC](#) [CR32NP-181KC](#) [CR32NP-1R5MC](#) [CR32NP-390KC](#) [CR32NP-3R9MC](#) [CR32NP-680KC](#) [CR32NP-820KC](#)

[CR32NP-8R2MC](#) [CR43NP-390KC](#) [CR43NP-560KC](#) [CR43NP-680KC](#) [CR54NP-181KC](#) [CR54NP-470LC](#) [CR54NP-820KC](#) [CR54NP-8R5MC](#)

[MGDQ4-00004-P](#) [MGDU1-00016-P](#) [MHL1ECTTP18NJ](#) [MHL1JCTTD12NJ](#) [PE-51506NL](#) [PE-53601NL](#) [PE-53630NL](#) [PE-53824SNLT](#) [PE-](#)

[62892NL](#) [PE-92100NL](#) [PG0434.801NLT](#) [PG0936.113NLT](#) [PM06-2N7](#) [PM06-39NJ](#) [HC2LP-R47-R](#) [HC2-R47-R](#) [HC3-2R2-R](#) [HC8-1R2-R](#)