



Multilayer Band Pass Filter

For 4200-4760MHz

DEA204480BT-3019B2

2.0x1.25mm [EIA 0805]*

* Dimensions Code JIS[EIA]

Multilayer Band Pass Filter

Conformity to RoHS Directive

For 4200-4760MHz

DEA204480BT-3019B2

SHAPES AND DIMENSIONS

[Top view]

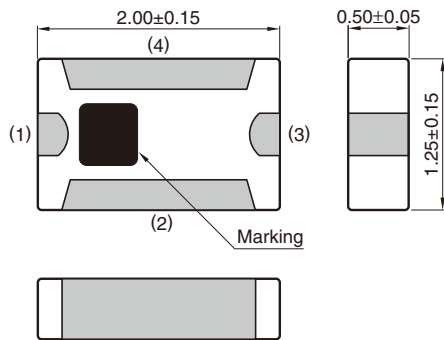

[Bottom view]

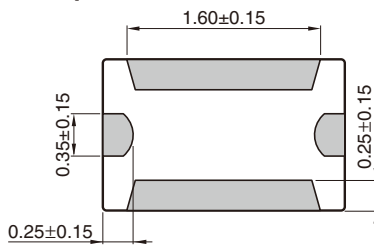

Terminal functions

1	IN/(OUT)
2	GND
3	OUT/(IN)
4	GND

Dimensions in mm

RECOMMENDED LAND PATTERN

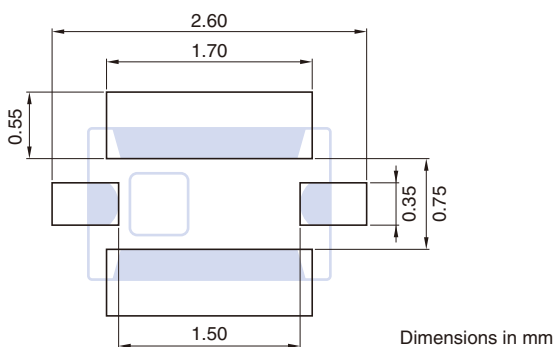

Dimensions in mm

○ RoHS Directive Compliant Product: See the following for more details related to RoHS Directive compliant products. <http://product.tdk.com/en/environment/rohs/>

- All specifications are subject to change without notice.
- Before using these products, be sure to request the delivery specifications.

DEA204480BT-3019B2

ELECTRICAL CHARACTERISTICS

Item	Frequency Range (MHz)	Min.	Typ.	Max.
Insertion Loss (dB)	4200 to 4760	—	2.52	3.3
	4200 to 4760	—	—	3.6 (−40 to +85°C)
Return Loss (dB)	4200 to 4760	9.54	16.5	—
Ripple (dB)	4200 to 4760	—	0.65	2.2
Attenuation (dB)	DC to 2000	40	53.5	—
	2400 to 2500	40	63.1	—
	3200 to 3800	20	29.1	—
	5150	18	46.3	—
	5160 to 5170	22.5	56.5	—
	5170 to 5850	28	35.8	—
	8960	30	41.6	—
Group Delay Ripple (ns)	4200 to 4760	—	0.26	0.60
Characteristic Impedance (Ω)			50 (Nominal)	

· Ta: +25±5°C

TEMPERATURE RANGE

Operating temperature (°C)	Storage temperature (°C)
−40 to +85	−40 to +85

- All specifications are subject to change without notice.
- Before using these products, be sure to request the delivery specifications.

DEA204480BT-3019B2

FREQUENCY CHARACTERISTICS

INSERTION LOSS

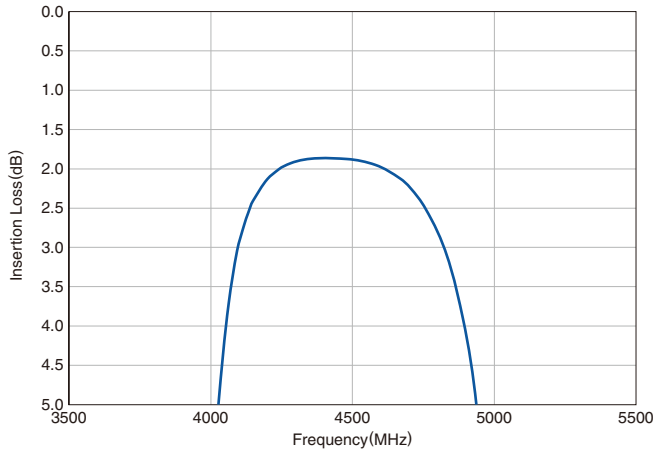

ATTENUATION

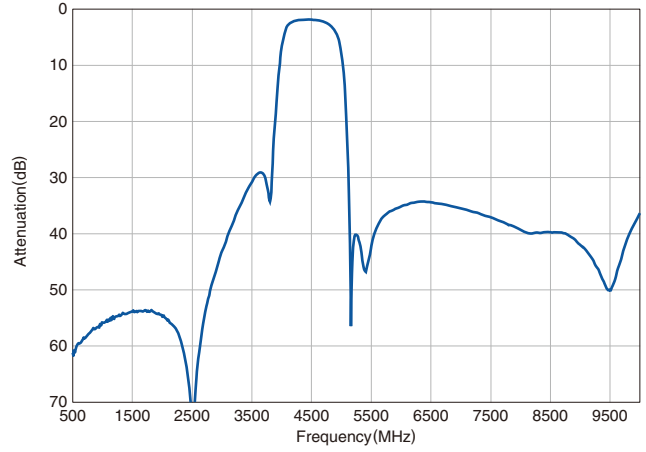

VSWR

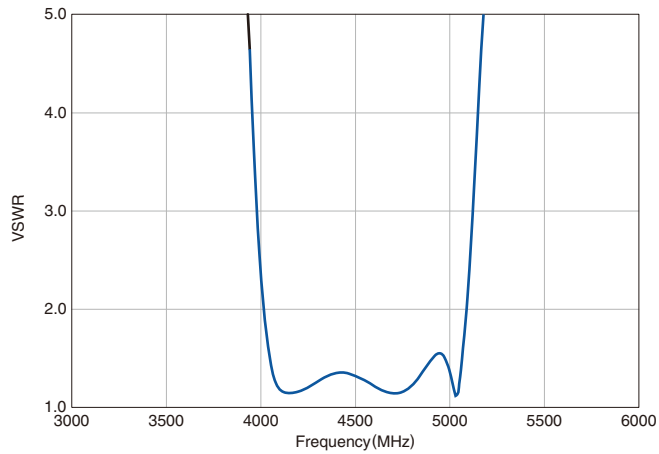

GROUP DELAY

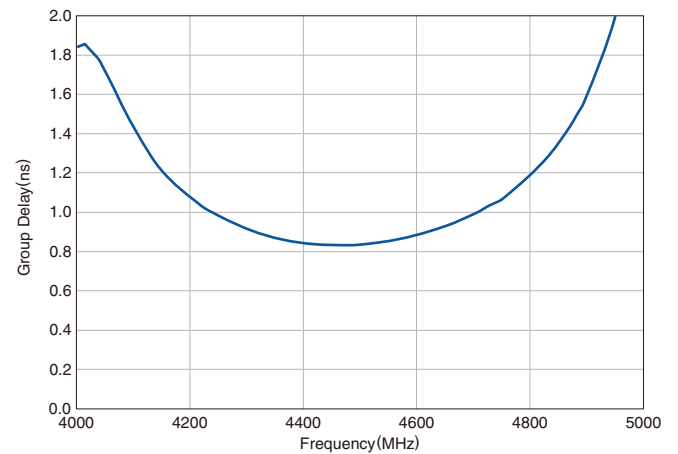

- All specifications are subject to change without notice.
- Before using these products, be sure to request the delivery specifications.

RECOMMENDED REFLOW PROFILE

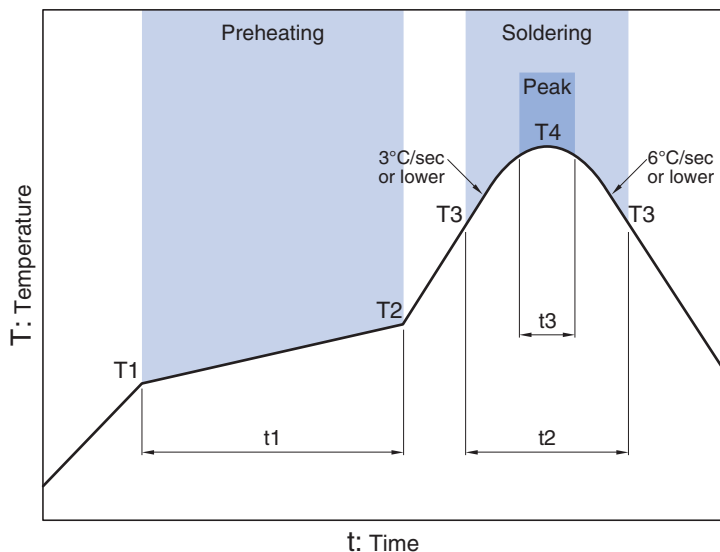

Preheating			Soldering			
Temp.	Temp.	Time	Critical zone (T3 to T4)		Temp.	Time
T1	T2	t1	T3	t2	T4	t3*
150°C	200°C	60 to 120sec	217°C	60 to 120sec	240 to 260°C	30sec max.

* t3 : Time within 5°C of actual peak temperature
 The maximum number of reflow is 3.

REMINDERS FOR USING THESE PRODUCTS

Before using these products, be sure to request the delivery specifications.

SAFETY REMINDERS

Please pay sufficient attention to the warnings for safe designing when using these products.

REMINDERS

The products listed on this catalog are intended for use in general electronic equipment (AV equipment, telecommunications equipment, home appliances, amusement equipment, computer equipment, personal equipment, office equipment, measurement equipment, industrial robots) under a normal operation and use condition.

The products are not designed or warranted to meet the requirements of the applications listed below, whose performance and/or quality require a more stringent level of safety or reliability, or whose failure, malfunction or trouble could cause serious damage to society, person or property.

Please understand that we are not responsible for any damage or liability caused by use of the products in any of the applications below or for any other use exceeding the range or conditions set forth in this catalog.

- | | |
|---|--|
| (1) Aerospace/Aviation equipment | (8) Public information-processing equipment |
| (2) Transportation equipment (cars, electric trains, ships, etc.) | (9) Military equipment |
| (3) Medical equipment | (10) Electric heating apparatus, burning equipment |
| (4) Power-generation control equipment | (11) Disaster prevention/crime prevention equipment |
| (5) Atomic energy-related equipment | (12) Safety equipment |
| (6) Seabed equipment | (13) Other applications that are not considered general-purpose applications |
| (7) Transportation control equipment | |

When using this product in general-purpose applications, you are kindly requested to take into consideration securing protection circuit/equipment or providing backup circuits, etc., to ensure higher safety.

X-ON Electronics

Largest Supplier of Electrical and Electronic Components

Click to view similar products for [Signal Conditioning category](#):

Click to view products by [TDK manufacturer](#):

Other Similar products are found below :

[MAPDCC0004](#) [PD0409J5050S2HF](#) [880157](#) [HHS-109-PIN](#) [DC1417J5005AHF](#) [DC4859J5005AHF](#) [AFS14A30-2185.00-T3](#) [DS-323-PIN](#)
[DSS-313-PIN](#) [B39321R801H210](#) [B39921B4317P810](#) [1A0220-3](#) [2089-6207-00](#) [JP510S](#) [LFB212G45SG8C341](#) [LFB322G45SN1A504](#)
[LFL182G45TC3B746](#) [SF2159E](#) [30057](#) [1P510S](#) [CER0813B](#) [3A325](#) [40287](#) [41180](#) [ATB3225-75032NCT](#) [B69842N5807A150](#)
[BD0810N50100AHF](#) [BD2425J50200AHF](#) [HMC189AMS8TR](#) [C5060J5003AHF](#) [JHS-114-PIN](#) [JHS-115-PIN](#) [JP503AS](#) [DC0710J5005AHF](#)
[DC2327J5005AHF](#) [DC3338J5005AHF](#) [43020](#) [LFB2H2G60BB1C106](#) [LFL15869MTC1B787](#) [X3C19F1-20S](#) [XC3500P-20S](#) [10013-20](#)
[SF2081E](#) [SF2194E](#) [SF2238E](#) [CDBLB455KCAX39-B0](#) [RF1353C](#) [PD0922J5050D2HF](#) [600S150FTRB](#) [1E1305-3](#)