

# Socket Junction Systems

## MIL-T-81714 Series I Class D



### MIL-T-81714 Series II Junction Modules

The high pin count, low weight MIL-T-81714 Series II Socket Junction Module System is available in four basic module sizes, accommodating 12-26 AWG wire in a broad selection of bussing arrangements. Modules are supplied with the appropriate and specified MIL-C-39029/22 socket contacts.



**Feedback Modules**  
**Feedthru Modules**  
**Distribution Modules**



**Board Mount Modules**



**Ground Modules**



**Sealed Splices**



**Mounting Tracks**

### Key Features and Benefits

#### Improved Performance

Significant Ampenhnl Pcd design innovations over conventional Series II systems assure superior performance in wire sealing, contact alignment and retention, and module extraction.

#### Feedback Modules

The SJM feedback modules and mounting track system offer a lightweight junction system with a full range of bussing arrangements.

#### Distribution Modules

Distribution modules provide a variety of contact combinations for power distribution applications and have the same construction and features as the standard Series II modules.

#### Ground Modules

SJM grounding modules are available in both center stud and mounting flange versions.

#### Board Mount Pin Modules

The socket junction modules indicate on the following pages can also be provided in a solder pin version for mounting directly to printed circuit boards, providing a flexible, compact wiring package and eliminating the need for mounting track.

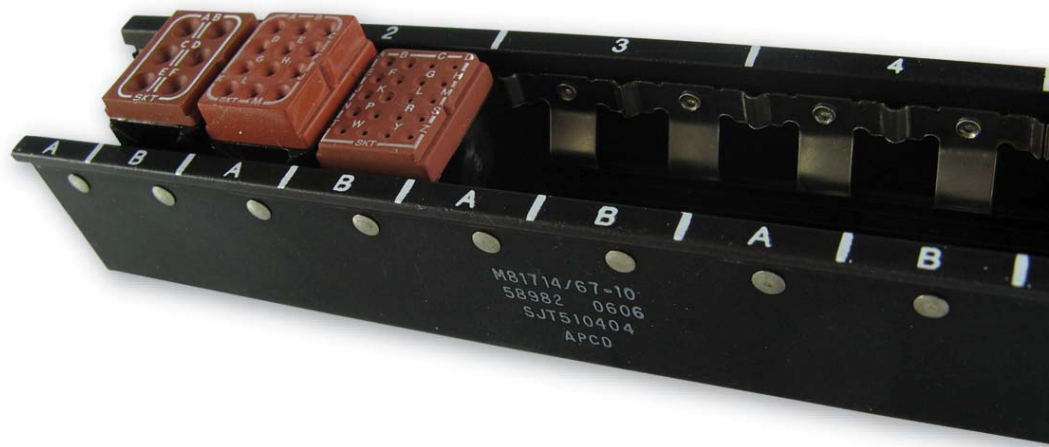

# Military Qualified, QPL-Listed MIL-T-81714 Series II, Class D

## Socket Junction Modules

| Military P/N    | Amphenol Pcd P/N | Page |
|-----------------|------------------|------|
| M81714/60-22-01 | SJM022100        | 49   |
| M81714/60-22-02 | SJM022200        | 49   |
| M81714/60-22-04 | SJM022400        | 49   |
| M81714/60-22-05 | SJM022500        | 49   |
| M81714/60-22-06 | SJM022600        | 49   |
| M81714/60-22-10 | SJM022700        | 49   |
|                 |                  |      |
| M81714/60-20-01 | SJM020100        | 50   |
| M81714/60-20-02 | SJM020200        | 50   |
| M81714/60-20-03 | SJM020300        | 50   |
| M81714/60-20-04 | SJM020400        | 50   |
| M81714/60-20-06 | SJM020600        | 50   |
|                 |                  |      |
| M81714/60-16-01 | SJM016100        | 51   |
| M81714/60-16-02 | SJM016200        | 51   |
| M81714/60-16-03 | SJM016300        | 51   |
|                 |                  |      |
| 51              |                  |      |
| M81714/60-12-01 | SJM012100        | 51   |
| M81714/60-12-02 | SJM012200        | 51   |
| M81714/60-12-03 | SJM012300        | 51   |
|                 |                  |      |
| M81714/61-0Z    | SJM000100        | 52   |
| M81714/61-0Y    | SJM000800        | 52   |
| M81714/61-0X    | SJM000200        | 52   |
| M81714/61-0W    | SJM000300        | 52   |

## Socket Grounding Modules

| Military P/N  | Amphenol Pcd P/N | Page |
|---------------|------------------|------|
| M81714/63-22S | SJG022170        | 54   |
| M81714/63-20S | SJG020170        | 54   |
| M81714/63-16S | SJG016170        | 54   |
| M81714/63-22F | SJG022270        | 55   |
| M81714/63-20F | SJG020270        | 55   |
| M81714/63-16F | SJG016270        | 55   |
| M81714/63-12F | SJG016270        | 55   |

## Socket Junction Module Mounting Track

| Military P/N | Amphenol Pcd P/N | Page |
|--------------|------------------|------|
| M81714/67-02 | SJT502404        | 59   |
| M81714/67-03 | SJT503404        | 59   |
| M81714/67-04 | SJT504404        | 59   |
| M81714/67-05 | SJT505404        | 59   |
| M81714/67-06 | SJT506404        | 59   |
| M81714/67-07 | SJT507404        | 59   |
| M81714/67-08 | SJT508404        | 59   |
| M81714/67-09 | SJT509404        | 59   |
| M81714/67-10 | SJT510404        | 59   |
| M81714/67-12 | SJT512404        | 59   |
| M81714/67-13 | SJT513404        | 59   |
| M81714/67-14 | SJT514404        | 59   |
| M81714/67-15 | SJT515404        | 59   |
| M81714/67-16 | SJT516404        | 59   |
| M81714/67-18 | SJT518404        | 59   |
| M81714/67-19 | SJT519404        | 59   |
| M81714/67-20 | SJT520404        | 59   |
| M81714/67-21 | SJT521404        | 59   |
| M81714/67-25 | SJT525404        | 59   |
| M81714/67-30 | SJT530404        | 59   |
| M81714/67-32 | SJT532404        | 59   |
| M81714/67-40 | SJT540404        | 59   |

## In-Line Junction Splices

| Military P/N   | Amphenol Pcd P/N | Page |
|----------------|------------------|------|
| M81714/65-16-1 | SJS316700        | 58   |
| M81714/65-20-1 | SJS320700        | 58   |
| M81714/65-22-1 | SJS322700        | 58   |
| M81714/65-16-2 | SJS316701        | 58   |
| M81714/65-20-2 | SJS320701        | 58   |
| M81714/65-22-2 | SJS322701        | 58   |

# M81714/60-22

## Series II Size 22

### Operating Range

**Temperature:**

-65°C to 200°C

**Insulation Resistance:**

5000 Megaohms @ 25°C

**Dielectric Withstanding Voltage:**

1500 VRMS at Sea Level

200 VRMS at 110,000 ft.

**Current Rating**

5 Amps

**Vibration & Shock:**

MIL-T-81714 Paragraph

3.5.5 and 3.5.8

### Materials

**Module Body:**

Polytherimide per ASTM-D5205

**Grommet:**

Silicone Blend Elastomer per A-A-59588

**Contact Retainers:**

Stainless Steel

**Internal Pin and Socket Contacts:**

Copper Alloy, Hard Gold Plated in

Accordance with MIL-G-45204

## Socket Junction Modules



## Amphenol Pcd Socket Junction Modules

| Bussing Configurations | Part Numbers    |           | Contact |                   |            |
|------------------------|-----------------|-----------|---------|-------------------|------------|
|                        | Military P/N    | APCD P/N  | QTY*    | Size <sup>1</sup> | P/N M39029 |
|                        | M81714/60-22-01 | SJM022100 | 20      | 22/22             | /22-191    |
|                        | M81714/60-22-02 | SJM022200 | 20      | 22/22             | /22-191    |
|                        | M81714/60-22-04 | SJM022400 | 20      | 22/22             | /22-191    |
|                        | M81714/60-22-05 | SJM022500 | 20      | 22/22             | /22-191    |
|                        | M81714/60-22-06 | SJM022600 | 20      | 22/22             | /22-191    |
|                        | M81714/60-22-07 | SJM022700 | 20      | 22/22             | /22-191    |

\* Quantity figure denotes number of contacts accommodated by module. Modules are supplied with one additional spare contacts and two sealing plugs.

<sup>1</sup> Mating End / Wire Barrel.

## Socket Junction Module Dimensions

### Front & Side View

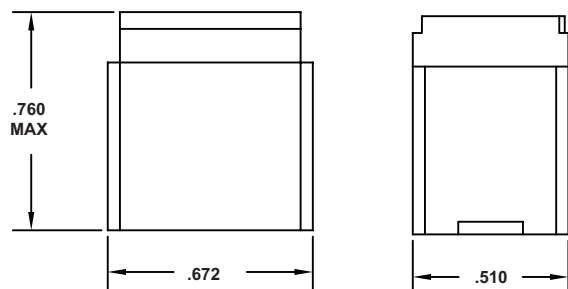

### Top View

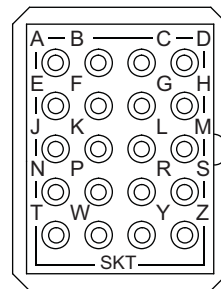

M81714/60-22-01 SHOWN



# Amphenol Pcd

## Socket Junction Modules

# M81714/60-20

## Series II Size 20



### Operating Range

**Temperature:**

-65°C to 200°C

**Insulation Resistance:**

5000 Megaohms @ 25°C

**Dielectric Withstanding Voltage:**

1500 VRMS at Sea Level

200 VRMS at 110,000 ft.

**Current Rating**

7.5 Amps

**Vibration & Shock:**

MIL-T-81714 Paragraph

3.5.5 and 3.5.8

### Materials

**Module Body:**

Polyetherimide per ASTM-D5205

**Grommet:**

Silicone Blend Elastomer per A-A-59588

**Contact Retainers:**

Stainless Steel

**Internal Pin and Socket Contacts:**

Copper Alloy, Hard Gold Plated in

Accordance with MIL-G-45204

## Amphenol Pcd Socket Junction Modules

| Bussing Configurations | Part Numbers    |           | Contact |                   |            |
|------------------------|-----------------|-----------|---------|-------------------|------------|
|                        | Military P/N    | APCD P/N  | QTY*    | Size <sup>1</sup> | P/N M39029 |
|                        | M81714/60-20-01 | SJM020100 | 12      | 20/20             | /22-192    |
|                        | M81714/60-20-02 | SJM020200 | 12      | 20/20             | /22-192    |
|                        | M81714/60-20-03 | SJM020300 | 12      | 20/20             | /22-192    |
|                        | M81714/60-20-04 | SJM020400 | 12      | 20/20             | /22-192    |
|                        | M81714/60-20-06 | SJM020600 | 12      | 20/20             | /22-192    |

\* Quantity figure denotes number of contacts accommodated by module. Modules are supplied with one additional spare contacts and two sealing plugs.

<sup>1</sup> Mating End / Wire Barrel.



## Socket Junction Module Dimensions

### Front & Side View

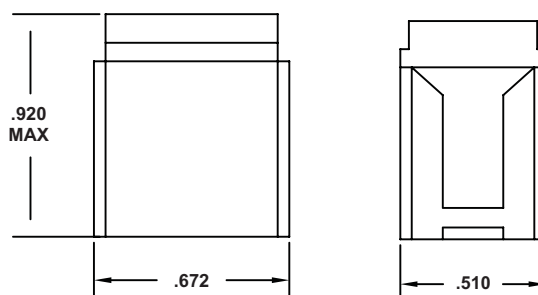

### Top View

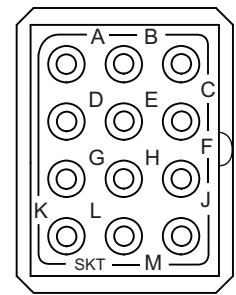

M81714/60-20-01 SHOWN

# M81714/60-16

## Series II Size 16

### Operating Range

**Temperature:**  
-65°C to 200°C

**Insulation Resistance:**  
5000 Megohms @ 25°C

**Dielectric Withstanding Voltage:**  
1500 VRMS at Sea Level  
200 VRMS at 110,000 ft.

**Current Rating**  
13 Amps

**Vibration & Shock:**  
MIL-T-81714 Paragraph  
3.5.5 and 3.5.8

### Materials

**Module Body:**  
Polyetherimide per ASTM-D5205

**Grommet:**  
Silicone Blend Elastomer per A-A-59588

**Contact Retainers:**  
Stainless Steel

**Internal Pin and Socket Contacts:**  
Copper Alloy, Hard Gold Plated in  
Accordance with MIL-G-45204

## Socket Junction Modules



## Amphenol Pcd Socket Junction Modules

| Bussing Configurations | Part Numbers    |           | Contact |                   |            |
|------------------------|-----------------|-----------|---------|-------------------|------------|
|                        | Military P/N    | APCD P/N  | QTY*    | Size <sup>1</sup> | P/N M39029 |
|                        | M81714/60-16-01 | SJM016100 | 6       | 16/16             | /22-193    |
|                        | M81714/60-16-02 | SJM016200 | 6       | 16/16             | /22-193    |
|                        | M81714/60-16-03 | SJM016300 | 6       | 16/16             | /22-193    |

\* Quantity figure denotes number of contacts accommodated by module. Modules are supplied with one additional spare contacts and two sealing plugs.

<sup>1</sup> Mating End / Wire Barrel.

## Socket Junction Module Dimensions

### Front & Side View

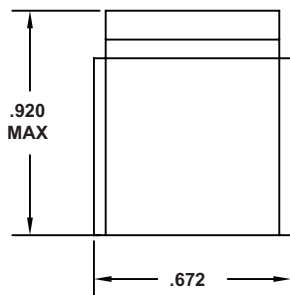

### Top View

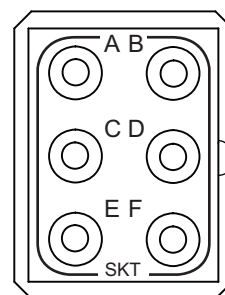

M81714/60-16-01 SHOWN



# Amphenol Pcd

## Socket Junction Modules

# M81714/60-12

## Series II Size 12



### Operating Range

#### Temperature:

-65°C to 200°C

#### Insulation Resistance:

5000 Megaohms @ 25°C

#### Dielectric Withstanding Voltage:

1500 VRMS at Sea Level

200 VRMS at 110,000 ft.

#### Current Rating

23 Amps

#### Vibration & Shock:

MIL-T-81714 Paragraph

3.5.5 and 3.5.8

### Materials

#### Module Body:

Polyetherimide per ASTM-D5205

#### Grommet:

Silicone Blend Elastomer per A-A-59588

#### Contact Retainers:

Stainless Steel

#### Internal Pin and Socket Contacts:

Copper Alloy, Hard Gold Plated in

Accordance with MIL-G-45204

## Amphenol Pcd Socket Junction Modules

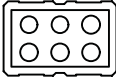
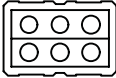
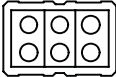
| Bussing Configurations  | Part Numbers    |           | Contact |                   |            |
|---|-----------------|-----------|---------|-------------------|------------|
|   | Military P/N    | APCD P/N  | QTY*    | Size <sup>1</sup> | P/N M39029 |
|    | M81714/60-12-01 | SJM012100 | 6       | 12/12             | /22-605    |
|  | M81714/60-12-02 | SJM012200 | 6       | 12/12             | /22-605    |
|  | M81714/60-12-03 | SJM012300 | 6       | 12/12             | /22-605    |

\* Quantity figure denotes number of contacts accommodated by module. Modules are supplied with one additional spare contacts and two sealing plugs.

<sup>1</sup> Mating End / Wire Barrel.



## Socket Junction Module Dimensions

### Front & Side View

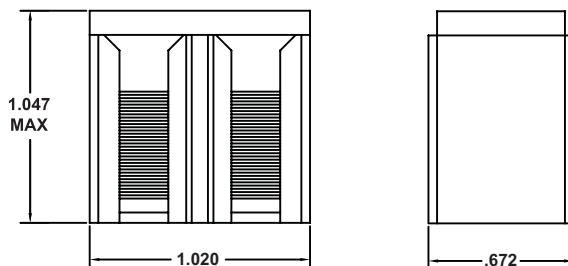

### Top View

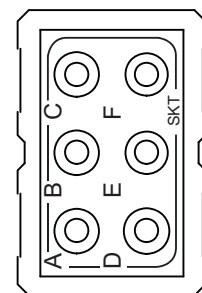

M81714/60-12-01 SHOWN

# M81714/61 Series II

## Distribution Socket Junction Modules

### Socket Junction Modules

#### Operating Range

**Temperature:**

-65°C to 200°C

**Insulation Resistance:**

5000 Megaohms @ 25°C

**Dielectric Withstanding Voltage:**

1500 VRMS at Sea Level

200 VRMS at 110,000 ft.

**Current Rating**

5 Amps (Size 22)

7.5 Amps (Size 20)

13 Amps (Size 16)

23 Amps (Size 12)

**Vibration & Shock:**

MIL-T-81714 Paragraph

3.5.5 and 3.5.8

#### Materials

**Module Body:**

Polyetherimide per ASTM-D5205

**Grommet:**

Silicone Blend Elastomer per A-A-59588

**Contact Retainers:**

Stainless Steel

**Internal Pin and Socket Contacts:**

Copper Alloy, Hard Gold Plated in  
Accordance with MIL-G-45204



### Amphenol Pcd Socket Junction Modules

| Bussing Configurations | Part Numbers |           | Contact |      |            | Bussing   |
|------------------------|--------------|-----------|---------|------|------------|---|
|                        | Military P/N | APCD P/N  | QTY     | Size | P/N M39029 | Bus Description   |
|                        | M81714/61-0Z | SJM000100 | 6       | 16   | /22-193    | 1 BUS<br>TWO SIZE 12 &<br>SIX SIZE 16                         |
|                        |              |           | 2       | 12   | /22-605    |   |
|                        | M81714/61-0Y | SJM000800 | 6       | 20   | /22-192    | 1 BUS<br>TWO SIZE 16 &<br>SIX SIZE 20                         |
|                        |              |           | 2       | 16   | /22-193    |   |
|                        | M81714/61-0X | SJM000200 | 6       | 16   | /22-193    | 2 BUSES<br>ONE SIZE 12 &<br>THREE SIZE 16 PER BUS             |
|                        |              |           | 2       | 12   | /22-605    |   |
|                        | M81714/61-0W | SJM000500 | 5       | 22   | /22-191    | 5 BUSES<br>ONE SIZE 22 & ONE SIZE 20<br>& ONE SIZE 16 PER BUS |
|                        |              |           | 5       | 20   | /22-192    |   |
|                        |              |           | 5       | 16   | /22-193    |   |

### Socket Junction Module Dimensions

#### Front View

##### M81714/61-0Y

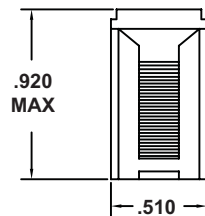

##### M81714/61-0Z, M81714/61-0X, M81714/61-0W

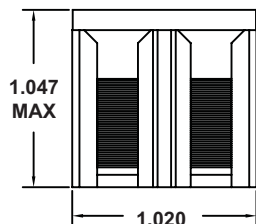

#### Side View

##### M81714/61-0Y

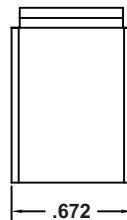

##### M81714/61-0Z, M81714/61-0X, M81714/61-0W

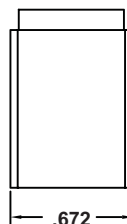

### Product Description

Distribution Socket Junction Modules are available in a variety of MIL-T-81714 configurations, feature the same construction and features as the standard Series II high density modules, and are recommended for power distribution applications



# Amphenol Pcd

# M81714/63 Socket Ground Modules

## Stud Mount Series II Size 16, 20, 22

### Socket Junction Modules



#### Operating Range

**Temperature:**  
-65°C to 200°C

**Current Rating**  
5 Amps (Size 22)  
7.5 Amps (Size 20)  
13 Amps (Size 16)

**Vibration & Shock:**  
MIL-T-81714 Paragraph  
3.5.5 and 3.5.8

#### Materials

**Module Body:**  
Polyetherimide per ASTM-D5205

**Grommet:**  
Silicone Blend Elastomer per A-A-59588

**Stud / Shell:**  
Copper Alloy, Gold Plated per  
SAE-AMS-2422. Tin Plating per  
ASTM-B545 Also Available as an Alternate

**Contact Retainers:**  
Stainless Steel

**Socket Contacts:**  
Copper Alloy, Hard Gold Plated in  
Accordance with MIL-G-45204

### Socket Grounding Modules Part Numbers

#### Product Description

M81714/63, stud mount, socket grounding modules mount directly to a ground plane or ground lug creating a multi-wire sealed grounding device. The grounding modules could also be mounted to a bus bar for power distribution, sensing or metering. All mounting hardware is furnished and custom hardware configurations are available. The mounting stud is available in gold or tin plating.

#### Part Numbers

#### Contact

#### Stud

| Military P/N  | APCD P/N  | QTY* | Size <sup>1</sup> | P/N M39029 | Plating |
|---------------|-----------|------|-------------------|------------|---------|
| M81714/63-22S | SJG022170 | 20   | 22/22             | /22-191    | Gold    |
|               | SJG022100 | 20   | 22/22             | /22-191    | Tin     |
| M81714/63-20S | SJG020170 | 12   | 20/20             | /22-192    | Gold    |
|               | SJG020100 | 12   | 20/20             | /22-192    | Tin     |
| M81714/63-16S | SJG016170 | 6    | 16/16             | /22-193    | Gold    |
|               | SJG016100 | 6    | 16/16             | /22-193    | Tin     |

\* Quantity figure denotes number of contacts accommodated by module. Modules are supplied with one additional spare contacts and two sealing plugs  
<sup>1</sup> Mating End/ Wire Barrel



### Socket Junction Module Dimensions

#### Top View

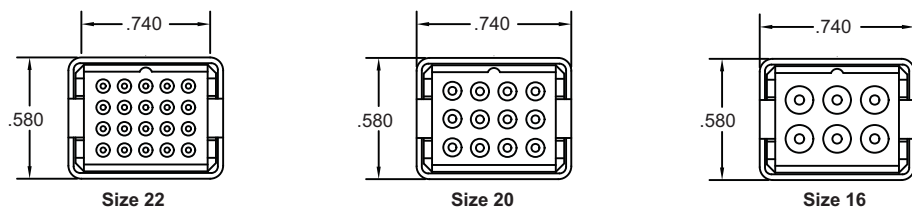

#### Side View

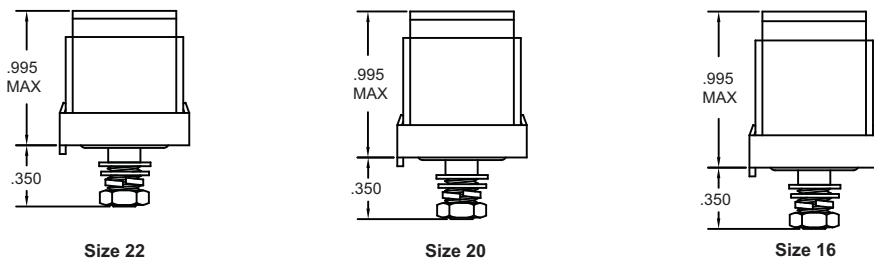



# M81714/63 Socket Ground Modules

## Flange Mount Series II Size 12, 16, 20, 22

### Operating Range

**Temperature:**

-65°C to 200°C

**Current Rating**

5 Amps (Size 22)

7.5 Amps (Size 20)

13 Amps (Size 16)

23 Amps (Size 12)

**Vibration & Shock:**

MIL-T-81714 Paragraph

3.5.5 and 3.5.8

### Materials

**Module Body:**

Polyetherimide per ASTM-D5205

**Grommet:**

Silicone Blend Elastomer per A-A-59588

**Flange / Shell:**

Copper Alloy, Gold Plated per SAE-AMS-2422. Tin Plating per ASTM-B545 Also Available as an Alternate

**Contact Retainers:**

Stainless Steel

**Socket Contacts:**

Copper Alloy, Hard Gold Plated in Accordance with MIL-G-45204

## Socket Junction Modules



## Socket Grounding Modules Part Numbers

| Part Numbers  |           |      | Contact           |            | Flange  |
|---------------|-----------|------|-------------------|------------|---------|
| Military P/N  | APCD P/N  | QTY* | Size <sup>1</sup> | P/N M39029 | Plating |
| M81714/63-22F | SJG022270 | 20   | 22/22             | /22-191    | Gold    |
|               | SJG022200 | 20   | 22/22             | /22-191    | Tin     |
| M81714/63-20F | SJG020270 | 12   | 20/20             | /22-192    | Gold    |
|               | SJG020200 | 12   | 20/20             | /22-192    | Tin     |
| M81714/63-16F | SJG016270 | 6    | 16/16             | /22-193    | Gold    |
|               | SJG016200 | 6    | 16/16             | /22-193    | Tin     |
| M81714/63-12F | SJG012270 | 6    | 12/12             | /22-605    | Gold    |
|               | SJG012200 | 6    | 12/12             | /22-605    | Tin     |

\* Quantity figure denotes number of contacts accommodated by module. Modules are supplied with one additional spare contacts and two sealing plugs  
<sup>1</sup> Mating End/ Wire Barrel

## Product Description

M81714/ 63, flange mount, socket grounding modules mount directly to a ground plane or ground lug creating a multi-wire sealed grounding device. The grounding modules could also be mounted to a bus bar for power distribution, sensing or metering. All mounting hardware is furnished and custom hardware configurations are available. The mounting stud is available in gold or tin plating.

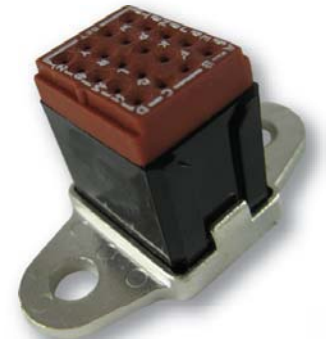

## Socket Junction Module Dimensions

### Top View

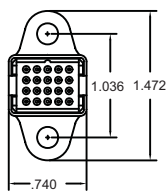

Size 22

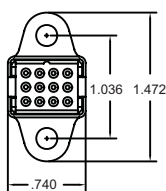

Size 20

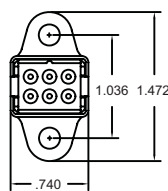

Size 16

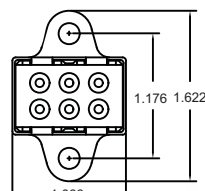

Size 12

### Side View

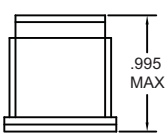

Size 22

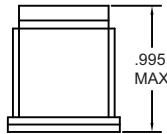

Size 20



Size 16

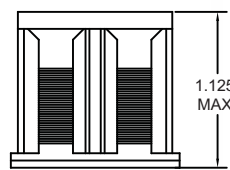

Size 12

# Amphenol Pcd

## Socket Junction Modules



# Board Mount Socket Junction Modules Series II Size 12, 16, 20, 22

### Operating Range

**Temperature:**

-65°C to 125°C

**Insulation Resistance:**

1000 Megaohms Min.

**Dielectric Withstanding Voltage:**

1500 VRMS at Sea Level

200 VRMS at 80,000 ft.

**Current rating:**

5 Amps (Size 22)

7.5 Amps (Size 20)

13 Amps (Size 16)

23 Amps (Size 12)

### Materials

**Module Body:**

Polytherimide per ASTM-D5205

**Grommet:**

Silicone Blend Elastomer per A-A-59588

**Contact Retainers:**

Stainless Steel

**Socket Contacts:**

Copper Alloy, Hard Gold Plated in

Accordance with MIL-G-45204

## Product Description

The socket junction modules indicate on the following pages can also be provided in a solder pin version for mounting directly to printed circuit boards, providing a flexible, compact wiring package and eliminating the need for mounting track. Please contact Amphenol Pcd for details on the SJP pin module.

## Module Configurations

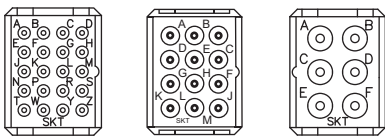

A

B

C



## Board Mount Socket Junctions

| APCD P/N  | QTY | Size  | Contact P/N   | Config. | DIM. L |
|-----------|-----|-------|---------------|---------|--------|
| SJP022000 | 20  | 22/22 | M39029/22-191 | A       | .187   |
| SJP022010 | 20  | 22/22 | M39029/22-191 | A       | .250   |
| SJP020000 | 12  | 20/20 | M39029/22-192 | B       | .187   |
| SJP020010 | 12  | 20/20 | M39029/22-192 | B       | .250   |
| SJP016000 | 6   | 16/16 | M39029/22-193 | C       | .187   |
| SJP016010 | 6   | 16/16 | M39029/22-193 | C       | .250   |
| SJP012000 | 6   | 12/12 | M39029/22-605 | D       | .187   |
| SJP012010 | 6   | 12/12 | M39029/22-605 | D       | .250   |
| SJP012010 | 6   | 12/12 | M39029/22-605 | D       | .335   |

## Board Mount Socket Junction Modules Dimensions

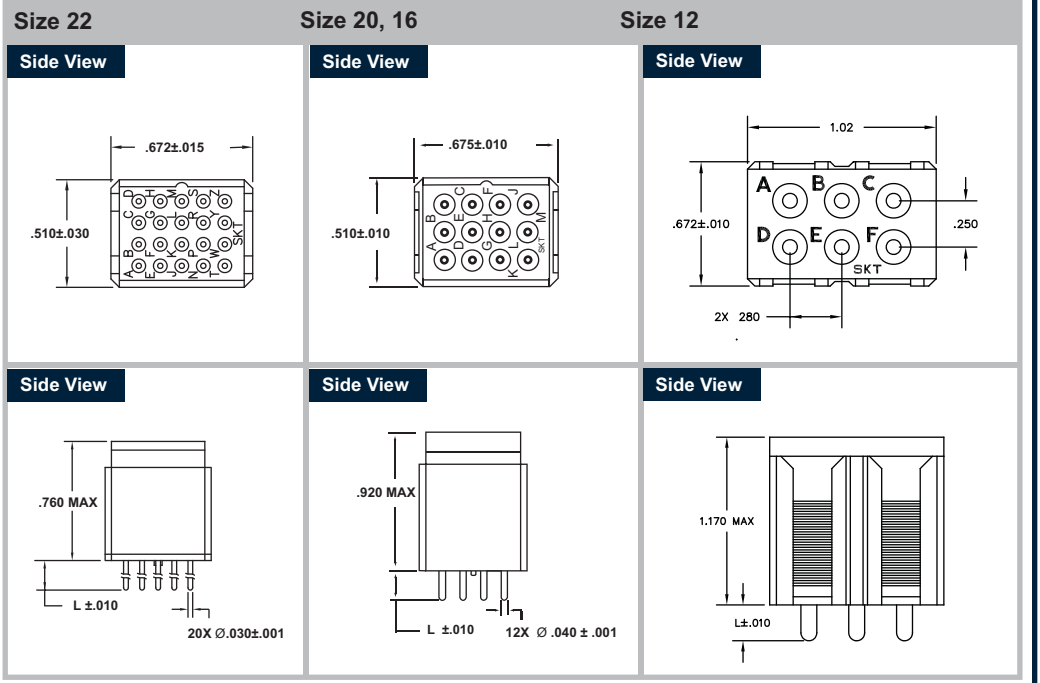

# Electronic Socket Junction Modules

## SJE Component Modules

### Operating Range

#### Temperature:

-65°C to 200°C

#### Insulation Resistance:

5000 Megaohms Min.

#### Dielectric Withstanding Voltage:

1500 VRMS at Sea Level

200 VRMS at 100,000 ft.

#### Vibration & Shock:

Per MIL-T-81714

Paragraph 3.5.5 & 3.5.8

### Materials

#### Insulator Body:

Polyetherimide per ASTM-D-5205

#### Grommet:

Silicone Rubber per A-A-59588

#### Internal Contact:

Copper Alloy, Gold Finish

per SAE-AMS-MIL-G-45204

## Socket Junction Modules



## Electronic Socket Junction Modules

| Circuit Diagram | APCD P/N  | Component | Quantity |
|-----------------|-----------|-----------|----------|
|                 | SJE020001 | Diode     | 5        |
|                 | SJE020003 | Diode     | 4        |
|                 | SJE020006 | Resistor  | 5        |
|                 | SJE020008 | Diode     | 2        |
|                 | SJE020009 | Diode     | 5        |
|                 | SJE020016 | Diode     | 5        |
|                 | SJE020017 | Resistor  | 4        |
|                 | SJE020022 | Diode     | 5        |
|                 | SJE020045 | Diode     | 5        |
|                 | SJE020290 | Resistor  | 2        |
|                 | SJE020297 | Fuse      | 5        |

## Product Descriptions

Amphenol Pcd's Electronic Socket Junction Modules are available with a variety of components and in a wide range of configurations. Components available include, but are not limited to, diodes, resistors, fuses, thyristors, and inductors, and are also available with multiple components within one module. There are new configurations produced regularly and customized components are also available.

## Junction Module Dimensions

### Side View

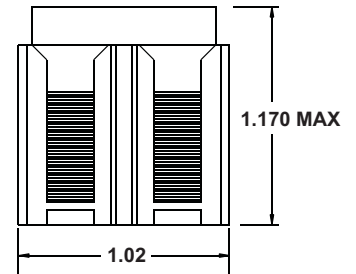

### Top View

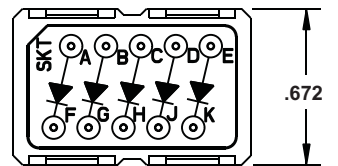

# Amphenol Pcd

# M81714/65 Sealed In-Line Splices

## SJS Series II Single and Double

### Socket Junction Splices



#### Operating Range

**Temperature:**  
-65°C to 200°C

**Insulation Resistance:**  
5000 Megaohms Min.

**Dielectric Withstanding Voltage:**  
1500 VRMS at Sea Level  
200 VRMS at 100,000 ft.

**Vibration & Shock:**  
Per MIL-T-81714  
Paragraph 3.5.5 & 3.5.8

**Current Rating:**  
13 Amps (Size 16)  
7.5 Amps (Size 20)  
5 Amps (Size 22)

#### Materials

**Insulator Body:**  
Polyetherimide per ASTM-D-5205

**Grommet:**  
Silicone Rubber per A-A-59588

**Internal Contact:**  
Copper Alloy, Gold Finish  
Accordance with MIL-G-45204

### Product Description

Series II In-Line Splices are available in single and double configurations in sizes 16, 20, and 22 AWG. These M81714/65 Splices use the same advanced polyetherimide body, one-piece bus assembly and construction as Amphenol Pcd's other M81714 connectors.

### Single SJS Splices

|  | Military P/N   | APCD P/N  | Ø Diameter |
|--|----------------|-----------|------------|
|  | M81714/65-16-1 | SJS316700 | .324 Max   |
|  | M81714/65-20-1 | SJS320700 | .290 Max   |
|  | M81714/65-22-1 | SJS322700 | .230 Max   |

### Sealed Splice Contacts

| In-Line Splice | Contact       |
|----------------|---------------|
| M81714/65-16-1 | M39029/22-193 |
| M81714/65-20-1 | M39029/22-192 |
| M81714/65-22-1 | M39029/22-191 |
| M81714/65-16-2 | M39029/22-193 |
| M81714/65-20-2 | M39029/22-192 |
| M81714/65-22-2 | M39029/22-191 |

### Double SJS Splices

|  | Military P/N   | APCD P/N  | A        | B        | C        |
|--|----------------|-----------|----------|----------|----------|
|  | M81714/65-16-2 | SJS316701 | .548 Max | .304 Max | .180 Max |
|  | M81714/65-20-2 | SJS320701 | .481 Max | .271 Max | .150 Max |
|  | M81714/65-22-2 | SJS322701 | .384 Max | .204 Max | .120 Max |

### Splice Dimensions

#### SJS Single Splice

##### Side View

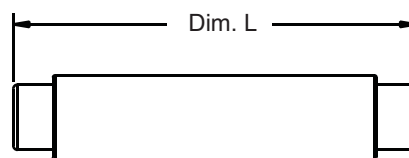

Wire Size      Dimension L

|         |           |
|---------|-----------|
| Size 16 | 1.452 Max |
| Size 20 | 1.434 Max |
| Size 22 | 1.310 Max |

#### SJS Double Splice

##### Side View

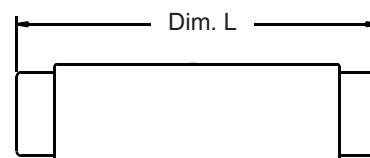

Wire Size      Dimension L

|         |           |
|---------|-----------|
| Size 16 | 1.428 Max |
| Size 20 | 1.428 Max |
| Size 22 | 1.322 Max |

# M81714/67 Series II

## Socket Junction Module Mounting Tracks

### Operating Range

**Temperature:**

-65° to 200°C

**Corrosion:**

No Exposure of Base Metal  
After 48 Hours of Salt Spray

**Magnetic Permeability:**

2.0 MU Max.

**Vibration and Shock:**

Per MIL-T-81714 Paragraph

3.5.5 and 3.5.8

### Materials

**Rail:**

Aluminum Alloy, Black Anodized

**Spring Clips:**

Stainless Steel

**Rivets:**

Stainless Steel

## Socket Junction Modules



## Socket Junction Modules Mounting Tracks

| Military P/N | APCD      | Mounting Pos.* | Dimensions |        |
|--------------|-----------|----------------|------------|--------|
|              |           |                | A          | B      |
| M81714/67-02 | SJT502404 | 2              | 1.036      | 0.518  |
| M81714/67-03 | SJT503404 | 3              | 1.554      | 1.036  |
| M81714/67-04 | SJT504404 | 4              | 2.072      | 1.554  |
| M81714/67-05 | SJT505404 | 5              | 2.590      | 2.072  |
| M81714/67-06 | SJT506404 | 6              | 3.108      | 2.590  |
| M81714/67-07 | SJT507404 | 7              | 3.626      | 3.108  |
| M81714/67-08 | SJT508404 | 8              | 4.144      | 3.626  |
| M81714/67-09 | SJT509404 | 9              | 4.662      | 4.144  |
| M81714/67-10 | SJT510404 | 10             | 5.180      | 4.662  |
| M81714/67-12 | SJT512404 | 12             | 6.216      | 5.698  |
| M81714/67-13 | SJT513404 | 13             | 6.734      | 6.216  |
| M81714/67-14 | SJT514404 | 14             | 7.252      | 6.734  |
| M81714/67-15 | SJT515404 | 15             | 7.770      | 7.252  |
| M81714/67-16 | SJT516404 | 16             | 8.288      | 7.770  |
| M81714/67-18 | SJT518404 | 18             | 9.324      | 8.806  |
| M81714/67-19 | SJT519404 | 19             | 9.842      | 9.324  |
| M81714/67-20 | SJT520404 | 20             | 10.360     | 9.842  |
| M81714/67-21 | SJT521404 | 21             | 10.878     | 10.360 |
| M81714/67-25 | SJT525404 | 25             | 12.950     | 12.432 |
| M81714/67-30 | SJT530404 | 30             | 15.540     | 15.022 |
| M81714/67-32 | SJT532404 | 32             | 16.576     | 16.058 |
| M81714/67-40 | SJT540404 | 40             | 20.720     | 20.202 |

\*Size 12 Modules require two mounting positions

### Removal Tools

| MIL P/N      | APCD P/N  | Description |
|--------------|-----------|-------------|
| M81714/69-01 | CNA051300 | Single      |
| M81714/69-02 | CNA052300 | Double      |

### Removal Tools

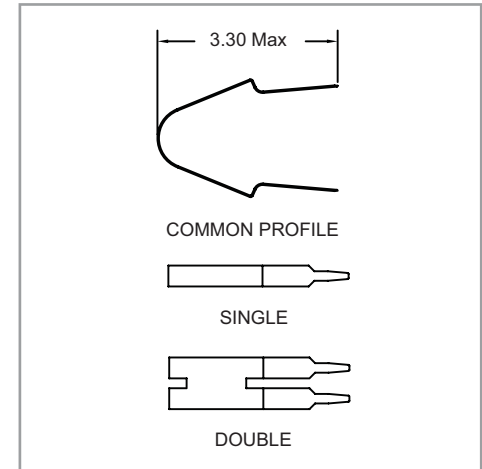

## Socket Junction Track Dimensions

### Top View

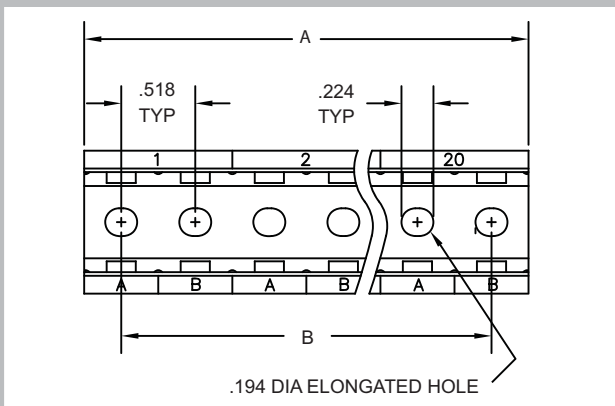

### Cross Section

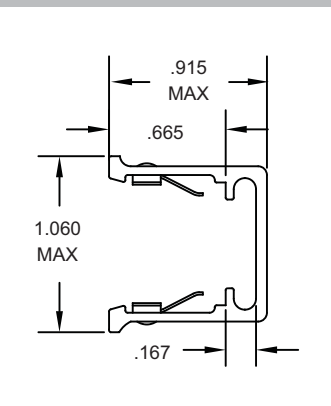

**Amphenol Pcd**

# M81714/67 Series II

## Composite Socket Junction Module Mounting Tracks

### Socket Junction Modules



#### Operating Range

##### Temperature:

-65° to 175°C

##### Vibration and Shock:

Per MIL-T-81714 Paragraph

3.5.5 and 3.5.8

#### Materials

##### Rail:

Glass Filled Polyetherimide,

Color: Black

### Product Description

The SJTC Mounting Track is fabricated of glass-filled polyetherimide which was selected for its unique combination of high strength, lightweight, chemical resistance and dimensional stability. The track is available with 2 through 20 mounting positions and is inter-changeable with existing aluminum track. The new track is 45% lighter than the aluminum track and 10% lighter than any other series II track available, and meets all dimensional requirements of MIL-T-81714.

### Composite Socket Junction Module Mounting Tracks

| Military Equivalent P/N | APCD P/N  | Mounting Pos. | Dimensions |       |
|-------------------------|-----------|---------------|------------|-------|
|                         |           |               | A          | B     |
| M81714/67-02            | SJTC02000 | 2             | 1.036      | 0.518 |
| M81714/67-03            | SJTC03000 | 3             | 1.554      | 1.036 |
| M81714/67-04            | SJTC04000 | 4             | 2.072      | 1.554 |
| M81714/67-05            | SJTC05000 | 5             | 2.590      | 2.072 |
| M81714/67-06            | SJTC06000 | 6             | 3.108      | 2.590 |
| M81714/67-07            | SJTC07000 | 7             | 3.626      | 3.108 |
| M81714/67-08            | SJTC08000 | 8             | 4.144      | 3.626 |
| M81714/67-09            | SJTC09000 | 9             | 4.662      | 4.144 |
| M81714/67-10            | SJTC10000 | 10            | 5.180      | 4.662 |
|                         | SJTC11000 | 11            | 5.698      | 5.180 |
| M81714/67-12            | SJTC12000 | 12            | 6.216      | 5.698 |
| M81714/67-13            | SJTC13000 | 13            | 6.734      | 6.216 |
| M81714/67-14            | SJTC14000 | 14            | 7.252      | 6.734 |
| M81714/67-15            | SJTC15000 | 15            | 7.770      | 7.252 |
| M81714/67-16            | SJTC16000 | 16            | 8.288      | 7.770 |
|                         | SJTC17000 | 17            | 8.806      | 8.288 |
| M81714/67-18            | SJTC18000 | 18            | 9.324      | 8.806 |
| M81714/67-19            | SJTC19000 | 19            | 9.842      | 9.324 |
| M81714/67-20            | SJTC20000 | 20            | 10.360     | 9.842 |

\*Size 12 Modules require two mounting positions

### Removal Tools

| MIL P/N      | APCD P/N  | Description |
|--------------|-----------|-------------|
| M81714/69-01 | CNA051300 | Single      |
| M81714/69-02 | CNA052300 | Double      |

### Removal Tools

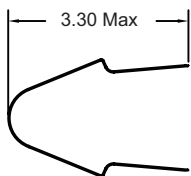

COMMON PROFILE

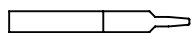

SINGLE

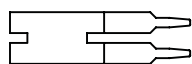

DOUBLE

### Composite Socket Junction Module Mounting Tracks

#### Top View

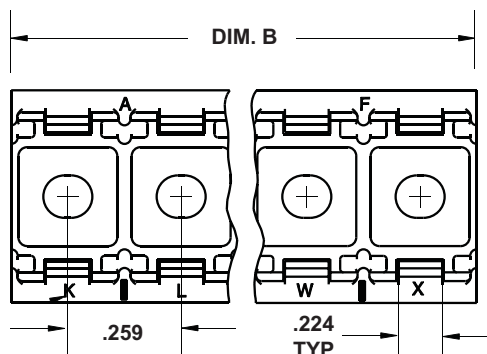

#### Cross Section

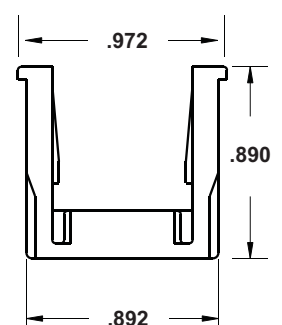

## X-ON Electronics

Largest Supplier of Electrical and Electronic Components

*Click to view similar products for [Socket Junction Modules](#) category:*

*Click to view products by [Amphenol](#) manufacturer:*

Other Similar products are found below :

[00610700081](#) [120-1833-000](#) [SJG016100](#) [SJG022171](#) [SJG022200](#) [SJM020601](#) [SJM022101](#) [107890-ZZ](#) [SJG020200](#) [SJM022501](#) [SJG020170](#)  
[M81714/61-0Z](#) [SJG022271](#) [SJM022701](#) [BTJ116E02B-513](#) [BTJ120E02C-513](#) [SJM020301](#) [SJM022601](#) [SJG016270](#) [SJG020271](#)  
[00175110600](#) [BTL-16-513](#) [00111510102](#) [BTM-16](#) [SJM000800](#) [BTM-22-513](#) [BTL-16](#) [00175110200](#) [00170511156](#) [00175110800](#)  
[00175110700](#) [BTM-22](#) [00175110107](#) [SJE020016](#) [00175110507](#) [00111510502](#) [00175110300](#) [00111510202](#) [00175110207](#) [00175110400](#)  
[SJM012200](#) [SJM022201](#) [SJE020045](#) [SJM016101](#) [SJM016201](#) [SJM020101](#) [A85049124S25W](#) [A85049124S13W](#) [A85049124S17W](#)  
[A85049124S11W](#)