

AlGaInP Visible Laser Diode

ADL-65103TL

6-2D-LD65-030 REV.00

★650nm 10mW 50°C Low Current Operation

• Features

1. Better FFP performance
2. Higher power
3. High efficiency

• Applications

1. Laser levelers
2. Industrial laser markers / measuring instruments
3. Bar code readers

• Absolute maximum ratings

Parameter	Symbol	Condition	Rating	Unit
Light output power	P_O	CW	13	mW
Reverse voltage (LD)	V_{RL}	-	2	V
Reverse voltage (PD)	V_{RD}	-	30	V
Forward current (PD)	I_{FD}	-	10	mA
Case temperature	T_C	-	-10~+50	°C
Storage temperature	T_S	-	-40~+85	°C

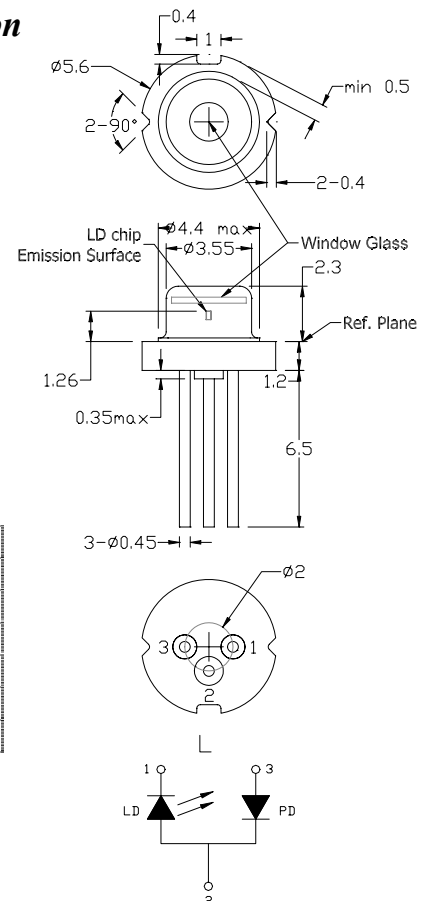

• Electrical and optical characteristics ($T_c=25^\circ\text{C}$)

Parameter	Symbol	Min.	Typ.	Max.	Unit	Conditions
Peak wavelength	λ	645	650	660	nm	$P_o=10\text{mW}$
Threshold current	I_{th}	-	20	25	mA	
Operating current	I_{op}	-	31	40	mA	$P_o=10\text{mW}$
Operating voltage	V_{op}	-	2.2	2.5	V	$P_o=10\text{mW}$
Differential efficiency	η	0.7	0.9	1.2	mW/mA	$P_o=7-10$
Monitor current	I_m	0.1	0.3	0.4	mA	$P_o=10\text{mW}, V_{RD}=5\text{V}$
Parallel divergence angle	$\theta_{ }$	6	9.5	12	deg	
Perpendicular divergence angle	θ_{\perp}	25	28	32	deg	
Parallel FFP deviation angle	$\Delta\theta_{ }$	-2	0	+2	deg	$P_o=10\text{mW}$
Perpendicular FFP deviation angle	$\Delta\theta_{\perp}$	-2	0	+2	deg	
Emission point accuracy	$\Delta x \Delta y \Delta z$	-80	0	+80	μm	

• Precautions

- Do not operate the device above maximum ratings. Doing so may cause unexpected and permanent damage to the device.
- Take precautions to avoid electrostatic discharge and/or momentary power spikes. A change in the characteristics of the laser or premature failure may result.
- Proper heat sinking of the device assures stability and lifetime. Always ensure that maximum operating temperatures are not exceeded.
- Observing visible or invisible laser beams with the human eye directly, or indirectly, can cause permanent damage. Use a camera to observe the laser.
- No laser device should be used in any application or situation where life or property is at risk in event of device failure.
- Specifications are subject to change without notice. Ensure that you have the latest specification by contacting us prior to purchase or use of the product

* For reference only. Contents above are subject to change without notice.

AlGaInP Visible Laser Diode

ADL-65103TL
6-2D-LD65-030_REV.00

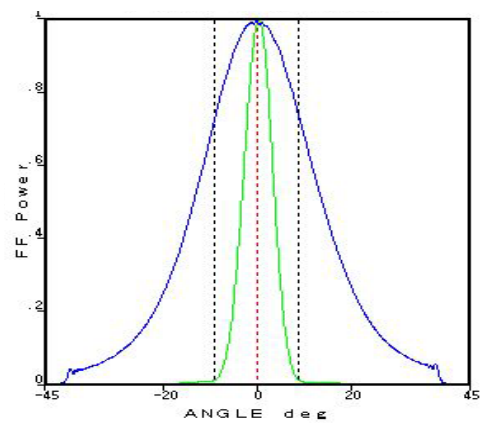
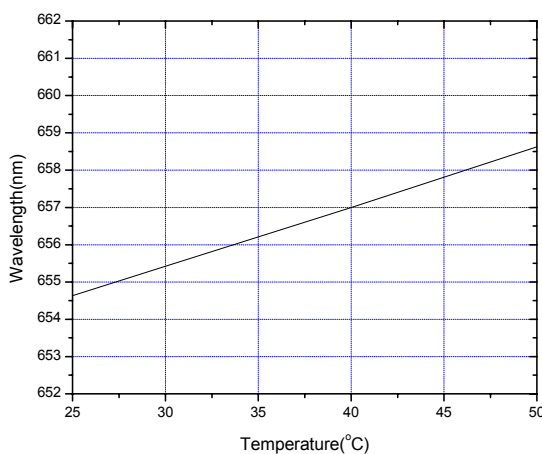
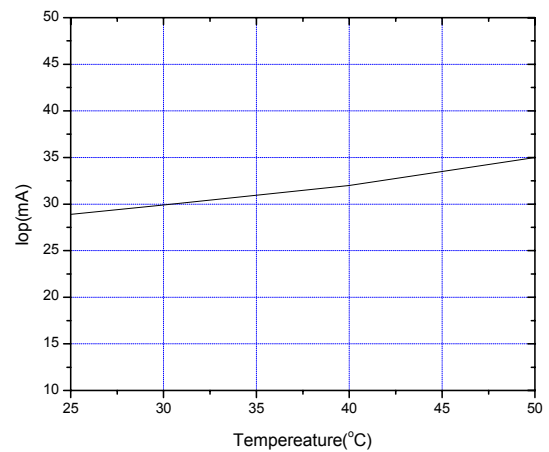
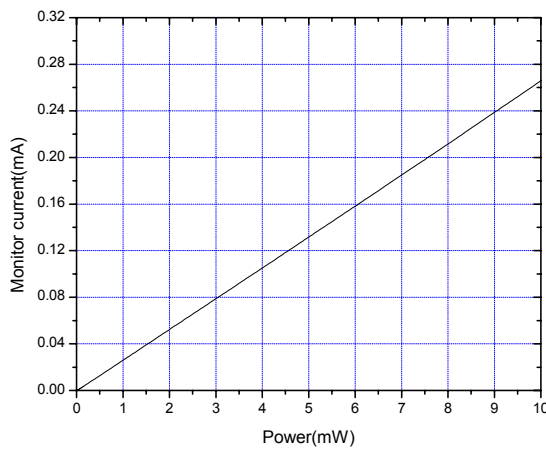
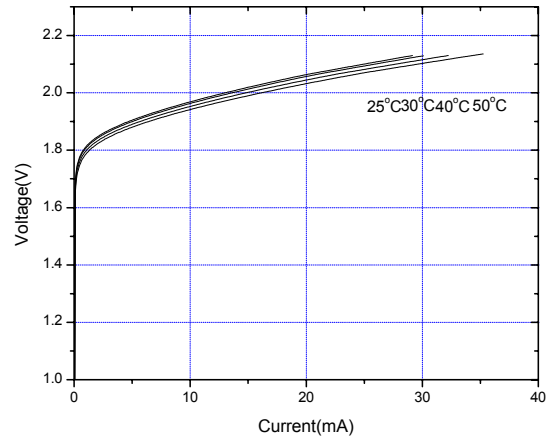
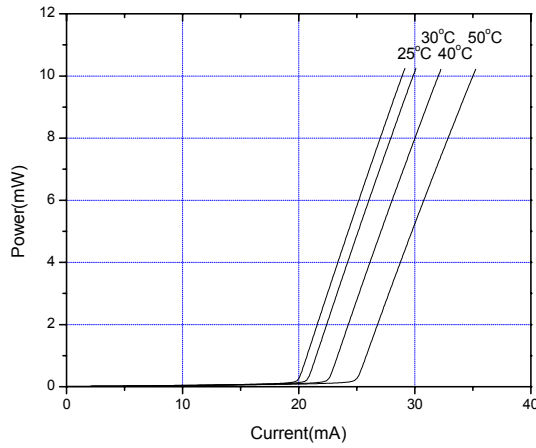

* For reference only. Contents above are subject to change without notice.

2 Germany & Other Countries
Laser Components GmbH
Tel: +49 8142 2864 - 0
Fax: +49 8142 2864 - 11
info@lasercomponents.com
www.lasercomponents.com

USA
Laser Components USA, Inc.
Tel: +1 603 821 - 7040
Fax: +1 603 821 - 7041
info@laser-components.com
www.laser-components.com

United Kingdom
Laser Components (UK) Ltd.
Tel: +44 1245 491 499
Fax: +44 1245 491 801
info@lasercomponents.co.uk
www.lasercomponents.co.uk

France
Laser Components S.A.S.
Tel: +33 1 39 59 52 25
Fax: +33 1 39 59 53 50
info@lasercomponents.fr
www.lasercomponents.fr

X-ON Electronics

Largest Supplier of Electrical and Electronic Components

Click to view similar products for [Laser Diodes](#) category:

Click to view products by [Laser Components](#) manufacturer:

Other Similar products are found below :

[PLT5 520EA P](#) [PLT3 520D](#) [905D1S03UA](#) [905D1S09UA](#) [905D1S3J03UA](#) [905D1S3J09UA](#) [ADL-63054SL](#) [ADL-63301TL](#) [ADL-63V0ANP](#)
[ADL-65055TL](#) [ADL-65074TA4](#) [ADL-65074TL-1](#) [ADL-65075SL](#) [ADL-65075TA4](#) [ADL-65104TA4](#) [ADL-65104TL](#) [ADL-66201TA4](#) [ADL-](#)
[66505TL](#) [ADL-66801TL](#) [ADL-78051TL](#) [ADL-78101TL](#) [ADL-83Z01TL](#) [ADL-83Z51TL](#) [ADL-85051TL](#) [ADL-85301TL](#) [ADL-85501TL](#)
[PLT3 450C](#) [LCU632051A](#) [LCU670561A](#) [HFE4081-321](#) [OPV315YBT](#) [PLT5 450B](#) [ADL-63054TL](#) [ADL-63102TL-3](#) [ADL-63153TL](#) [ADL-](#)
[65103TL](#) [ADL-66201TL](#) [PLT5 510](#) [LCU66A051A](#) [SPL LL90_3](#) [ADL-65075TL](#) [DFB-1310-10LR-LCA](#) [FP-1310-4I-LCB](#) [HFE4192-582](#)
[FP-1310-5I-50SMF-FCAPC](#) [PL 450B](#) [PL 520_B1](#) [PLPT5 450KA](#) [PLPT5 447KA](#) [PLPT9 450LA_E](#)