

## ADL-80Y05TL

### Infrared Laser Diode

#### 808nm 200mW High Power Operation

##### • Features

1. High pumping efficiency
2. Stable wavelength
3. High reliability

##### • Applications

1. Pumping source for DPSS green laser
2. Medical applications

##### • Absolute maximum ratings

Parameter	Symbol	Condition	Rating	Unit
Light output power	$P_O$	CW	220	mW
Reverse voltage (LD)	$V_{RL}$	-	2	V
Case temperature	$T_C$	-	-10~+50	°C
Storage temperature	$T_S$	-	-40~+85	°C

##### • Electrical and optical characteristics ( $T_C=25^\circ\text{C}$ )

Parameter	Symbol	Min.	Typ.	Max.	Unit	Conditions (CW)
Peak wavelength	$\lambda$	801	-	809	nm	$P_O=200\text{mW}$
Threshold current	$I_{th}$	-	60	100	mA	
Operating current	$I_{op}$	-	260	320	mA	
Operating voltage	$V_{op}$	-	1.9	2.2	V	$P_O=150\text{--}200\text{mW}$
Differential efficiency	$\eta$	0.8	1.0	-	mW/mA	
Monitor Current	$I_m$	0.3	-	2.4	mA	$P_O=200\text{mW}$
Parallel divergence angle	$\theta_{  }$	-	6	11	deg	$P_O=200\text{mW}$
Perpendicular divergence angle	$\theta_{\perp}$	-	28	40	deg	
Parallel FFP deviation angle	$\Delta\theta_{  }$	-3	0	+3	deg	
Perpendicular FFP deviation angle	$\Delta\theta_{\perp}$	-5	0	+5	deg	
Emission point accuracy	$\Delta x \Delta y \Delta z$	-80	0	+80	um	

##### • Precautions

- Do not operate the device above maximum ratings. Doing so may cause unexpected and permanent damage to the device.
- Take precautions to avoid electrostatic discharge and/or momentary power spikes. A change in the characteristics of the laser or premature failure may result.
- Proper heat sinking of the device assures stability and lifetime. Always ensure that maximum operating temperatures are not exceeded.
- Observing visible or invisible laser beams with the human eye directly, or indirectly, can cause permanent damage. Use a camera to observe the laser.
- No laser device should be used in any application or situation where life or property is at risk in event of device failure.
- Specifications are subject to change without notice. Ensure that you have the latest specification by contacting us prior to purchase or use of the product.

\* For reference only. Contents above are subject to change without notice.

T6-2D-LD80-001\_Rev.00

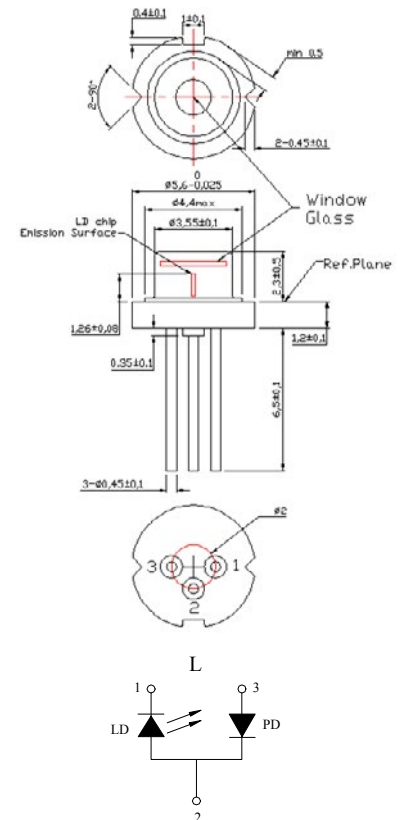

# Infrared Laser Diode

## ADL-80Y05TL T6-2D-LD80-001\_Rev.00

TENTATIVE

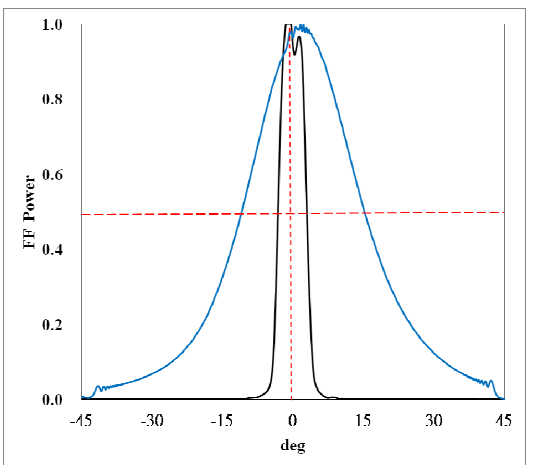
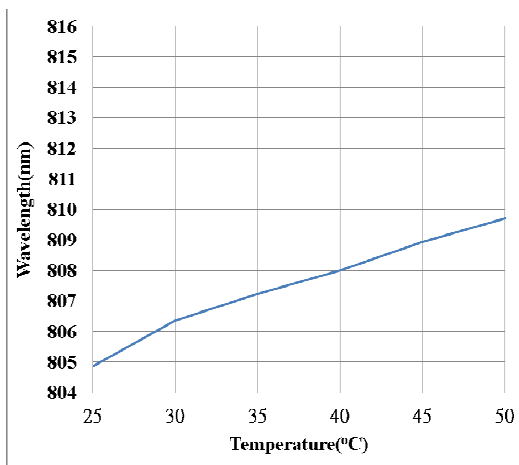
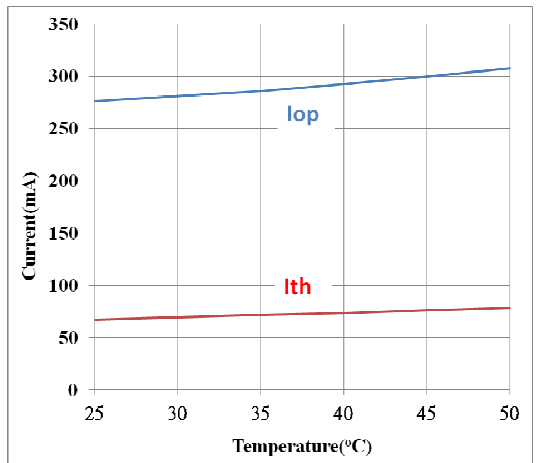
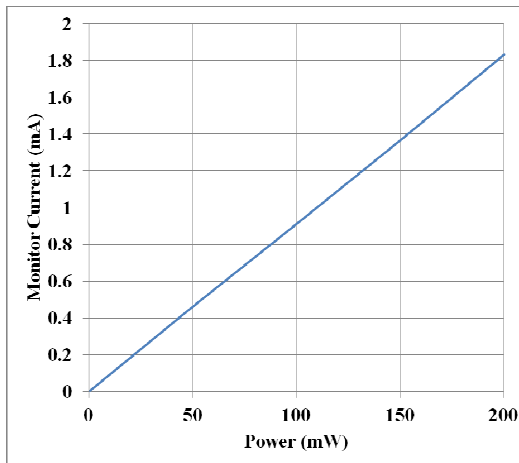
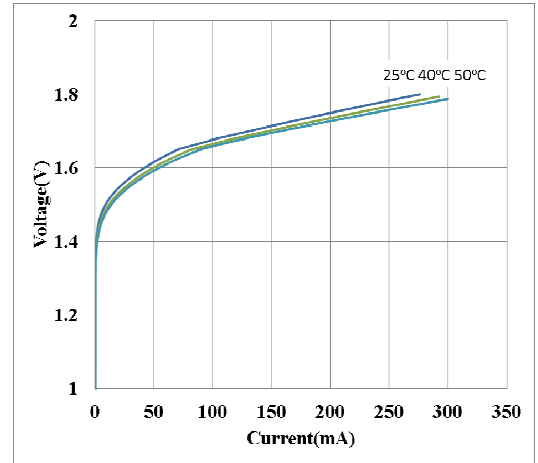
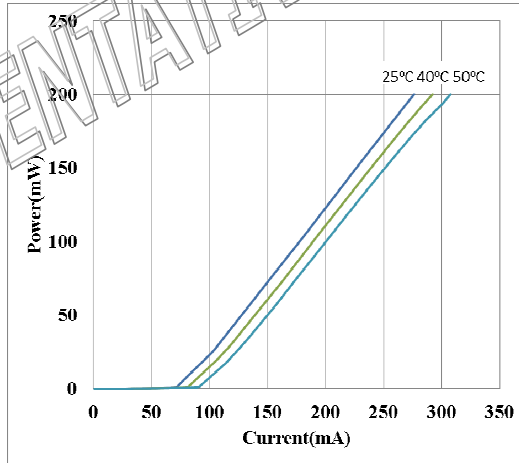

\* For reference only. Contents above are subject to change without notice.

## X-ON Electronics

Largest Supplier of Electrical and Electronic Components

*Click to view similar products for [Laser Diodes](#) category:*

*Click to view products by [Laser Components](#) manufacturer:*

Other Similar products are found below :

[PLT5 520EA P](#) [PLT3 520D](#) [905D1S03UA](#) [905D1S09UA](#) [905D1S3J03UA](#) [905D1S3J09UA](#) [ADL-63054SL](#) [ADL-63301TL](#) [ADL-63V0ANP](#)  
[ADL-65055TL](#) [ADL-65074TA4](#) [ADL-65074TL-1](#) [ADL-65075SL](#) [ADL-65075TA4](#) [ADL-65104TA4](#) [ADL-65104TL](#) [ADL-66201TA4](#) [ADL-](#)  
[66505TL](#) [ADL-66801TL](#) [ADL-78051TL](#) [ADL-78101TL](#) [ADL-83Z01TL](#) [ADL-83Z51TL](#) [ADL-85051TL](#) [ADL-85301TL](#) [ADL-85501TL](#)  
[PLT3 450C](#) [LCU632051A](#) [LCU670561A](#) [HFE4081-321](#) [OPV315YBT](#) [PLT5 450B](#) [ADL-63054TL](#) [ADL-63102TL-3](#) [ADL-63153TL](#) [ADL-](#)  
[65103TL](#) [ADL-66201TL](#) [PLT5 510](#) [LCU66A051A](#) [SPL LL90\\_3](#) [ADL-65075TL](#) [DFB-1310-10LR-LCA](#) [FP-1310-4I-LCB](#) [HFE4192-582](#)  
[FP-1310-5I-50SMF-FCAPC](#) [PL 450B](#) [PL 520\\_B1](#) [PLPT5 450KA](#) [PLPT5 447KA](#) [PLPT9 450LA\\_E](#)