



**Features**

- Wide input range 180 ~ 528VAC
- Constant Power mode output
- Metal housing with Class I design
- Built-in active PFC function
- Function options: output adjustable via potentiometer; 3 in 1 dimming (dim-to-off) ; Smart timer dimming
- Typical lifetime>50000 hours
- 5 years warranty

**Applications**

- Harbor lighting
- LED high-bay lighting
- Parking space lighting
- LED fishing lamp
- Type “HL” for use in Class I , Division 2 hazardous (Classified) location.

**Description**

HVGC-480 series is a 480W LED AC/DC driver featuring the constant power mode and high voltage output. HVGC-480 operates from 180~528VAC and offers models with different rated current ranging between 1400mA and 3500mA. Thanks to the high efficiency up to 94.5%, with the fanless design, the entire series is able to operate for -40°C~+90°C case temperature under free air convection. The design of metal housing and IP67 ingress protection level allows this series to fit both indoor and outdoor applications. HVGC-480 is equipped with various function options, such as dimming methodologies, so as to provide the optimal design flexibility for LED lighting system.

**Model Encoding**

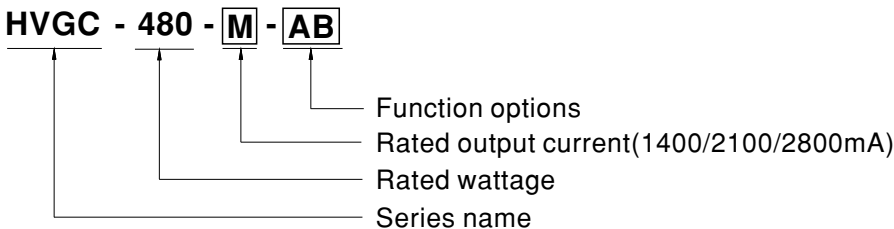

Type	IP Level	Function	Note
AB	IP65	Standard constant power output with 3 in 1 dimming function (0~10Vdc, 10V PWM signal and resistance) and built-in potentiometer.	In Stock
Blank	IP67	Io and Vo fixed.	By request
D2	IP67	Built-in Smart timer dimming and programmable function.	By request
Dx	IP67	Built-in Smart timer dimming function by user request.	By request
DA	IP67	DALI control technology.	By request



**SPECIFICATION**

MODEL		HVGC-480-L-□	HVGC-480-M-□	HVGC-480-H-□
OUTPUT	RATED CURRENT	1400mA	2100mA	2800mA
	RATED POWER	480W	480W	480W
	CONSTANT CURRENT REGION <small>Note.2</small>	137 ~ 343V	92 ~ 228.5V	68 ~ 171.5V
	FULL POWER CURRENT RANGE	1400~1750mA	2100~2625mA	2800~3500mA
	OPEN CIRCUIT VOLTAGE (max.)	350V	240V	180V
	CURRENT ADJ. RANGE(Typ.)	700~1750mA	1050~2625mA	1400~3500mA
	CURRENT RIPPLE	5.0% max. @rated current		
	CURRENT TOLERANCE	±5%		
SET UP TIME <small>Note.4</small>	500ms/230VAC, 347VAC, 480VAC			
INPUT	VOLTAGE RANGE <small>Note.3</small>	180 ~ 528VAC 254VDC ~ 747VDC (Please refer to "STATIC CHARACTERISTIC" section)		
	FREQUENCY RANGE	47 ~ 63Hz		
	POWER FACTOR (Typ.)	PF ≥ 0.98 / 230VAC, PF ≥ 0.98 / 277VAC, PF ≥ 0.97 / 347VAC, PF ≥ 0.96 / 400VAC, PF ≥ 0.95 / 480VAC at full load (Please refer to "Power Factor Characteristic" section)		
	TOTAL HARMONIC DISTORTION	THD < 20% (@ load ≥ 50% at 230VAC/277VAC/347VAC/400VAC/480VAC input (Please refer to "TOTAL HARMONIC DISTORTION (THD)" section)		
	EFFICIENCY (Typ.)	94.5%	94.5%	94.5%
	AC CURRENT (Typ.)	1.52A / 347VAC	1.11A / 480VAC	
	INRUSH CURRENT(Typ.)	COLD START 40A(t <sub>width</sub> =1100μs measured at 50% I <sub>peak</sub> ) at 480VAC; Per NEMA 410		
	MAX. NO. of PSUs on 16A CIRCUIT BREAKER	2 unit(circuit breaker of type B) / 4 units(circuit breaker of type C) at 480VAC		
LEAKAGE CURRENT	<0.75mA / 480VAC			
PROTECTION	SHORT CIRCUIT	Constant current limiting, recovers automatically after fault condition is removed		
	OVER VOLTAGE	351 ~ 381V	241 ~ 257V	181 ~ 193V
	OVER TEMPERATURE	Shut down output voltage, re-power on to recovery		
ENVIRONMENT	WORKING TEMP.	T <sub>case</sub> =-40 ~ +90°C (Please refer to "OUTPUT LOAD vs TEMPERATURE" section)		
	MAX. CASE TEMP.	T <sub>case</sub> =+90°C		
	WORKING HUMIDITY	20 ~ 95% RH non-condensing		
	STORAGE TEMP., HUMIDITY	-40 ~ +80°C, 10 ~ 95% RH non-condensing		
	TEMP. COEFFICIENT	±0.03%/°C (0 ~ 60°C)		
	VIBRATION	10 ~ 500Hz, 5G 12min./1cycle, period for 72min. each along X, Y, Z axes		
SAFETY & EMC	SAFETY STANDARDS	UL8750 (type"HL"), CSA C22.2 No. 250.13-14, ENEC EN61347-1, EN61347-2-13 independent, EN62384, IP65 or IP67, EAC TP TC 004 approved		
	WITHSTAND VOLTAGE	I/P-O/P:3.75KVAC I/P-FG:2KVAC O/P-FG:1.5KVAC		
	ISOLATION RESISTANCE	I/P-O/P, I/P-FG, O/P-FG:100M Ohms / 500VDC / 25°C / 70% RH		
	EMC EMISSION	Compliance to EN55015, EN61000-3-2 Class C (@ load ≥ 50%); EN61000-3-3, FCC Part 15 class B, EAC TP TC 020		
	EMC IMMUNITY	Compliance to EN61000-4-2,3,4,5,6,8,11, EN61547, light industry level (surge immunity Line-Earth 4KV, Line-Line 2KV), EAC TP TC 020		
OTHERS	MTBF	286.1K hrs min. Telcordia SR-332(Bellcore) ; 72.9K hrs min. MIL-HDBK-217F (25°C)		
	DIMENSION	262*125*43.8mm (L*W*H)		
	PACKING	2.72Kg;4pcs/11.45Kg/0.55CUFT		
NOTE	<ol style="list-style-type: none"> <li>All parameters NOT specially mentioned are measured at 347VAC input, rated current and 25°C of ambient temperature.</li> <li>Please refer to "DRIVING METHODS OF LED MODULE".</li> <li>De-rating may be needed under low input voltages. Please refer to "STATIC CHARACTERISTIC" sections for details.</li> <li>Length of set up time is measured at first cold start. Turning ON/OFF the power supply may lead to increase of the set up time.</li> <li>The driver is considered as a component that will be operated in combination with final equipment. Since EMC performance will be affected by the complete installation, the final equipment manufacturers must re-qualify EMC Directive on the complete installation again.</li> <li>This series meets the typical life expectancy of &gt;50,000 hours of operation when T<sub>case</sub>, particularly t<sub>c</sub> point (or TMP, per DLC), is about 80°C or less.</li> <li>Please refer to the warranty statement on MEAN WELL's website at <a href="http://www.meanwell.com">http://www.meanwell.com</a></li> <li>To fulfill requirements of the latest ErP regulation for lighting fixtures, this LED driver can only be used behind a switch without permanently connected to the mains.</li> <li>The ambient temperature derating of 3.5°C/1000m with fanless models and of 5°C/1000m with fan models for operating altitude higher than 2000m(6500ft).</li> </ol>			

## ■ BLOCK DIAGRAM

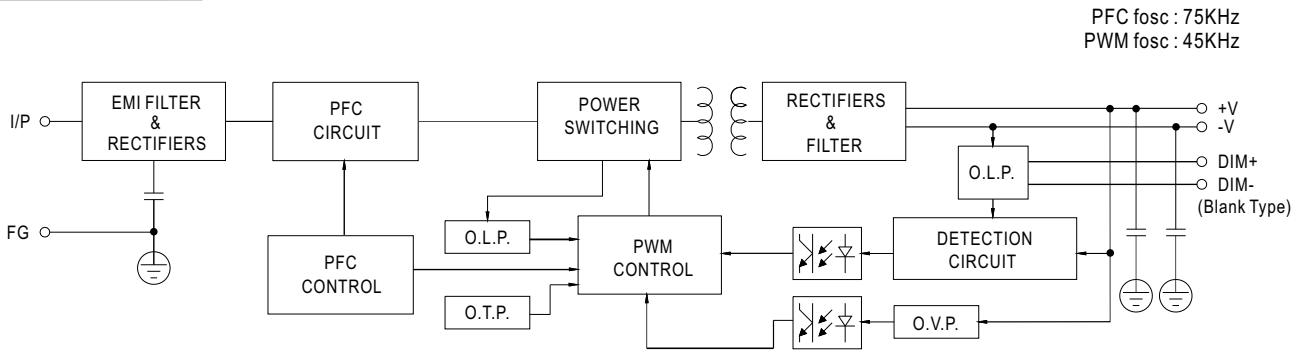

## ■ DRIVING METHODS OF LED MODULE

※ I-V Operating Area

◎ HVGC-480-L

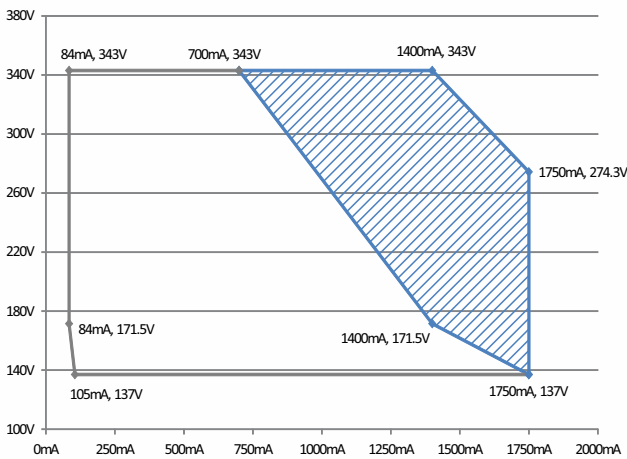

▨ Recommended High Performance Region □ Allowed Operational Region

◎ HVGC-480-M

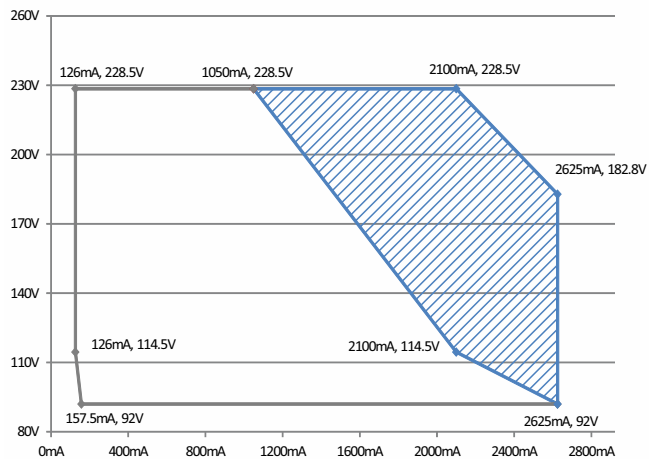

▨ Recommended High Performance Region □ Allowed Operational Region

◎ HVGC-480-H

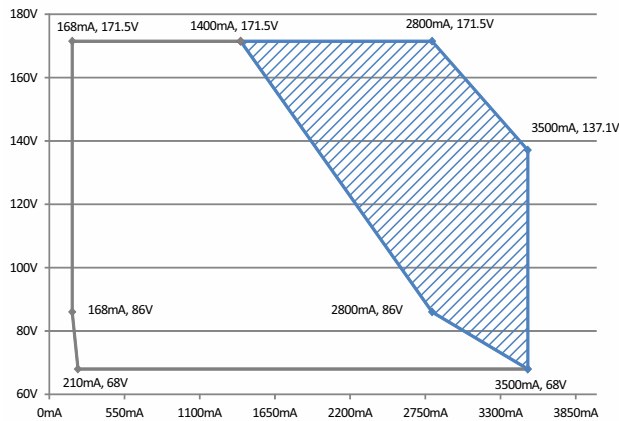

▨ Recommended High Performance Region □ Allowed Operational Region

## ■ DIMMING OPERATION

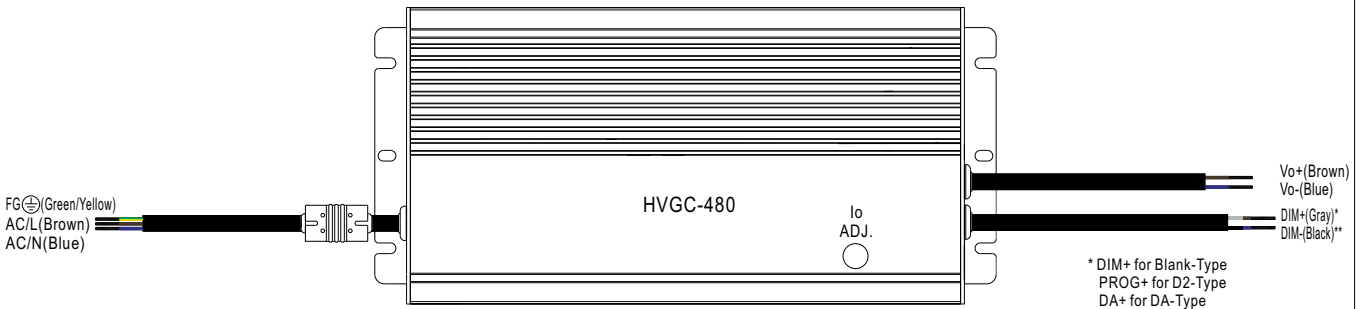

### ※ 3 in 1 dimming function (for AB-Type)

- Output constant current level can be adjusted by applying one of the three methodologies between DIM+ and DIM-: 0 ~ 10VDC, or 10V PWM signal or resistance.
- Direct connecting to LEDs is suggested. It is not suitable to be used with additional drivers.
- Dimming source current from power supply: 100 $\mu$ A (typ.)

#### ◎ Applying additive 0 ~ 10VDC

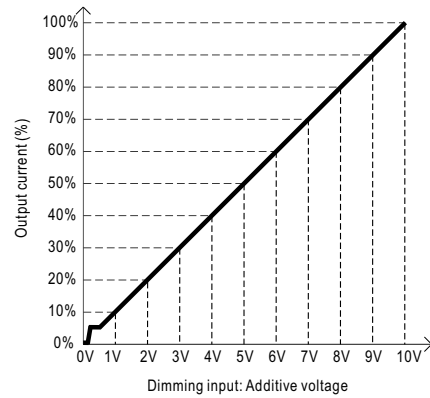
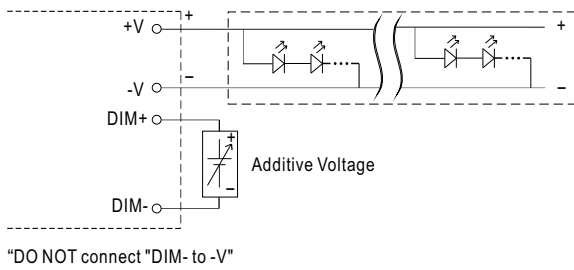

#### ◎ Applying additive 10V PWM signal (frequency range 100Hz ~ 3KHz):

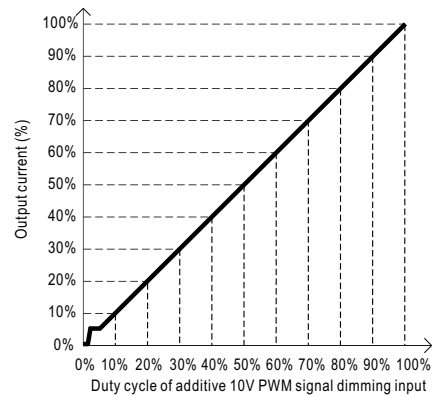
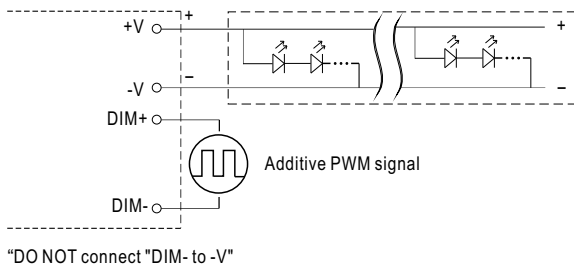

#### ◎ Applying additive resistance:

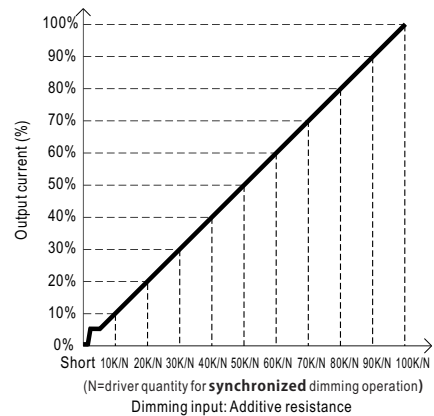
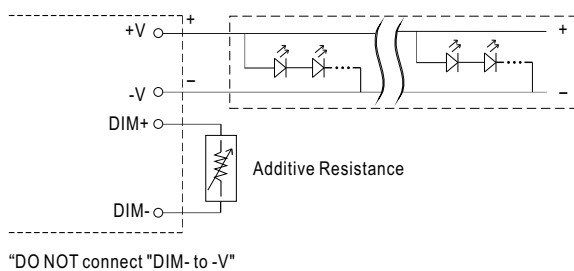

Note : 1. Min. dimming level is about 6% and the output current is not defined when 0% < Iout < 6%.

2. The output current could drop down to 0% when dimming input is about 0k $\Omega$  or 0Vdc, or 10V PWM signal with 0% duty cycle.

※ **Smart timer dimming function (for Dxx-Type by User definition)**

MEAN WELL Smart timer dimming primarily provides the adaptive proportion dimming profile for the output constant current level to perform up to 14 consecutive hours. 3 dimming profiles hereunder are defined accounting for the most frequently seen applications. If other options may be needed, please contact MEAN WELL for details.

Ex : ☉ D01-Type: the profile recommended for residential lighting

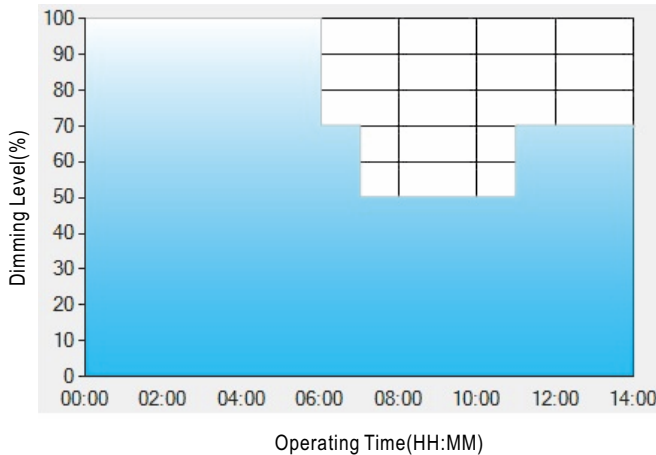

Set up for D01-Type in Smart timer dimming software program:

	T1	T2	T3	T4
TIME**	06:00	07:00	11:00	---
LEVEL**	100%	70%	50%	70%

\*\* : TIME matches Operating Time in the diagram whereas LEVEL matches Dimming Level.

Example: If a residential lighting application adopts D01-Type, when turning on the power supply at 6:00pm, for instance:

- [1] The power supply will switch to the constant current level at 100% starting from 6:00pm.
  - [2] The power supply will switch to the constant current level at 70% in turn, starting from 0:00am, which is 06:00 after the power supply turns on.
  - [3] The power supply will switch to the constant current level at 50% in turn, starting from 1:00am, which is 07:00 after the power supply turns on.
  - [4] The power supply will switch to the constant current level at 70% in turn, starting from 5:00am, which is 11:00 after the power supply turns on.
- The constant current level remains till 8:00am, which is 14:00 after the power supply turns on.

Ex : ☉ D02-Type: the profile recommended for street lighting

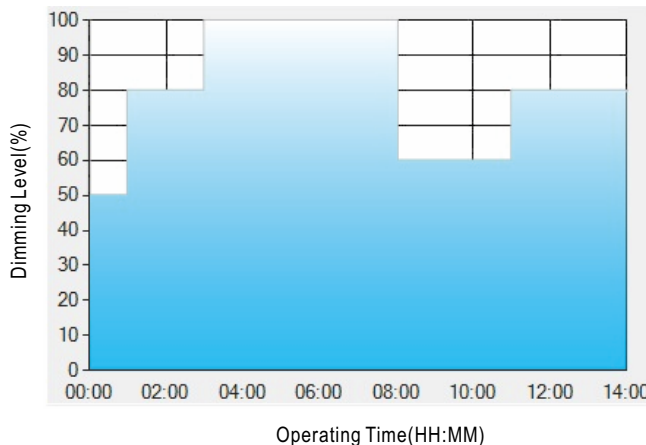

Set up for D02-Type in Smart timer dimming software program:

	T1	T2	T3	T4	T5
TIME**	01:00	03:00	8:00	11:00	---
LEVEL**	50%	80%	100%	60%	80%

\*\* : TIME matches Operating Time in the diagram whereas LEVEL matches Dimming Level.

Example: If a street lighting application adopts D02-Type, when turning on the power supply at 5:00pm, for instance:

- [1] The power supply will switch to the constant current level at 50% starting from 5:00pm.
- [2] The power supply will switch to the constant current level at 80% in turn, starting from 6:00pm, which is 01:00 after the power supply turns on.
- [3] The power supply will switch to the constant current level at 100% in turn, starting from 8:00pm, which is 03:00 after the power supply turns on.
- [4] The power supply will switch to the constant current level at 60% in turn, starting from 1:00am, which is 08:00 after the power supply turns on.
- [5] The power supply will switch to the constant current level at 80% in turn, starting from 4:00am, which is 11:00 after the power supply turns on. The constant current level remains till 6:30am, which is 14:00 after the power supply turns on.

Ex: ☉ D03-Type: the profile recommended for tunnel lighting

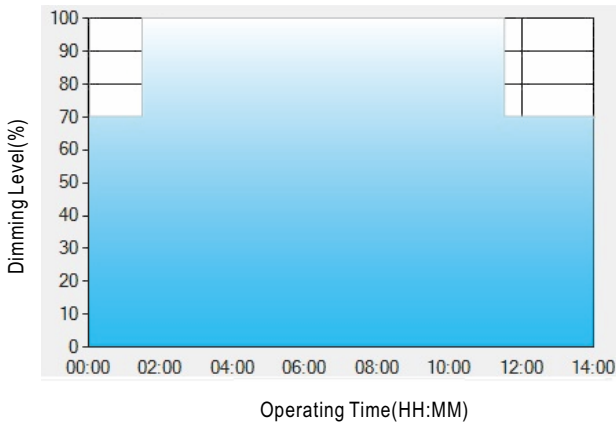

Set up for D03-Type in Smart timer dimming software program:

	T1	T2	T3
TIME**	01:30	11:00	---
LEVEL**	70%	100%	70%

\*\* : TIME matches Operating Time in the diagram whereas LEVEL matches Dimming Level.

Example: If a tunnel lighting application adopts D03-Type, when turning on the power supply at 4:30pm, for instance:

[1] The power supply will switch to the constant current level at 70% starting from 4:30pm.

[2] The power supply will switch to the constant current level at 100% in turn, starting from 6:00pm, which is 01:30 after the power supply turns on.

[3] The power supply will switch to the constant current level at 70% in turn, starting from 5:00am, which is 11:00 after the power supply turns on.

The constant current level remains till 6:30am, which is 14:00 after the power supply turns on.

※ **DALI interface(primary side; for DA-Type)**

- Apply DALI signal between DA+ and DA-.
- DALI protocol comprises 16 groups and 64 addresses.
- First step is fixed at 6% of output.

### OUTPUT LOAD vs TEMPERATURE

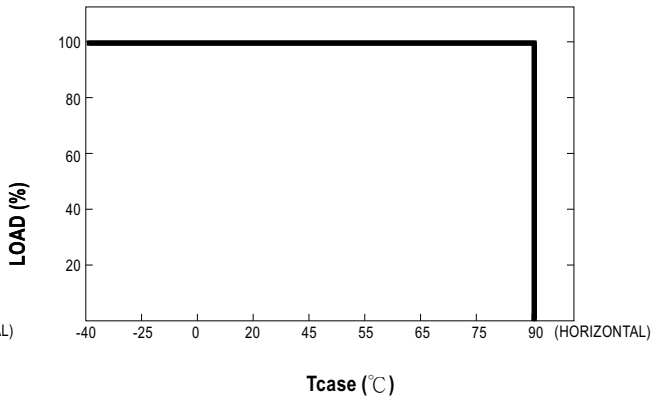
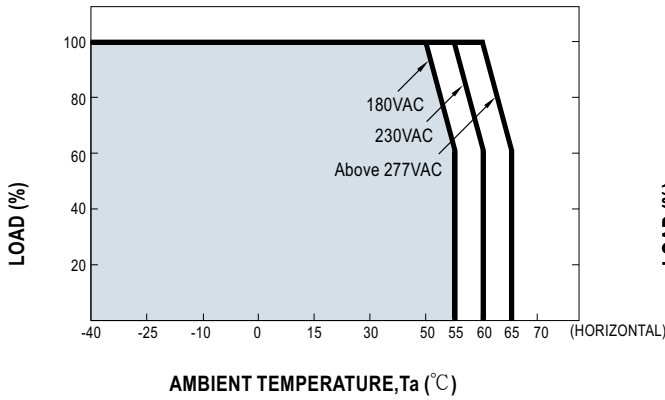

If HVGC-480 operates in Constant Power mode with the rated current, the maximum workable Ta is 55°C (Typ. 230VAC)

### STATIC CHARACTERISTIC

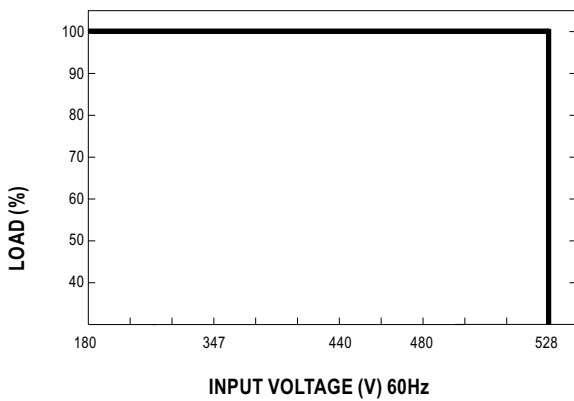

### POWER FACTOR (PF) CHARACTERISTIC

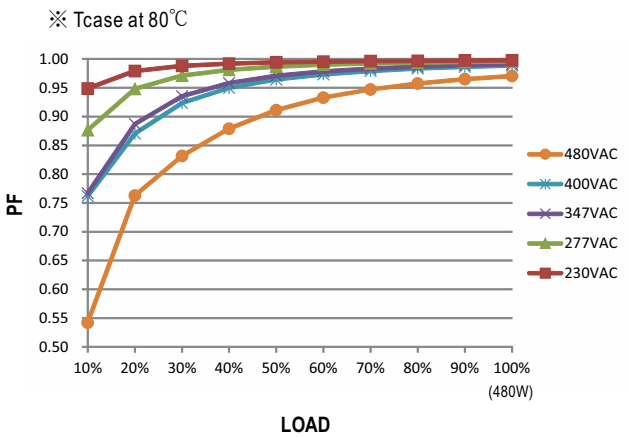

### TOTAL HARMONIC DISTORTION (THD)

※ L Model, Tcase at 80°C

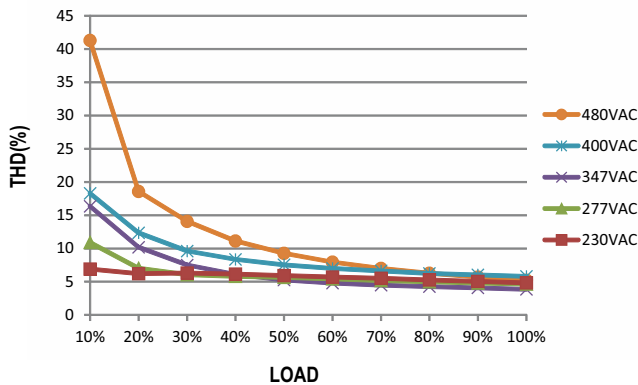

### EFFICIENCY vs LOAD

HVGC-480 series possess superior working efficiency that up to 94.5% can be reached in field applications.

※ L Model, Tcase at 80°C

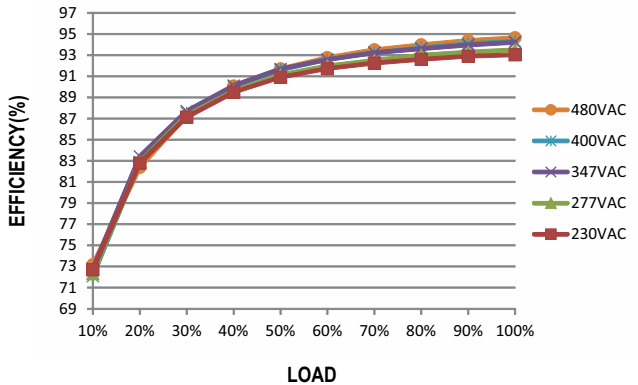

■ LIFE TIME

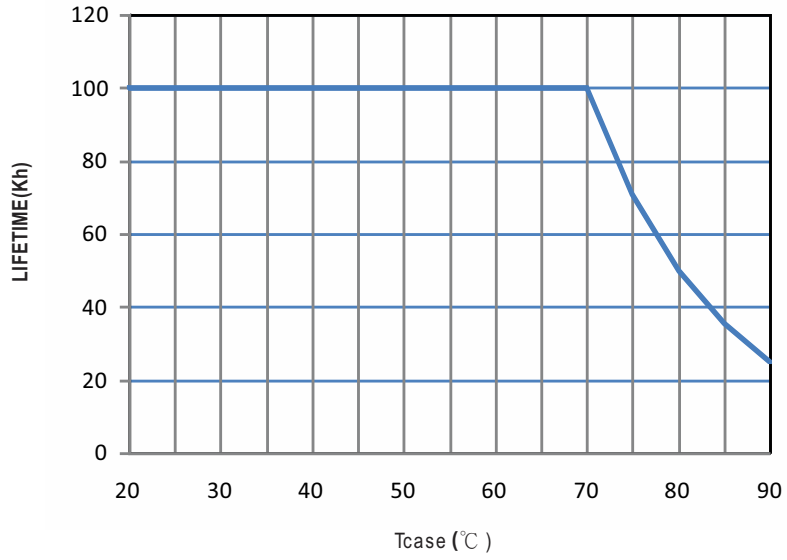



**MECHANICAL SPECIFICATION**

Case No. 251 Unit:mm

※AB-Type

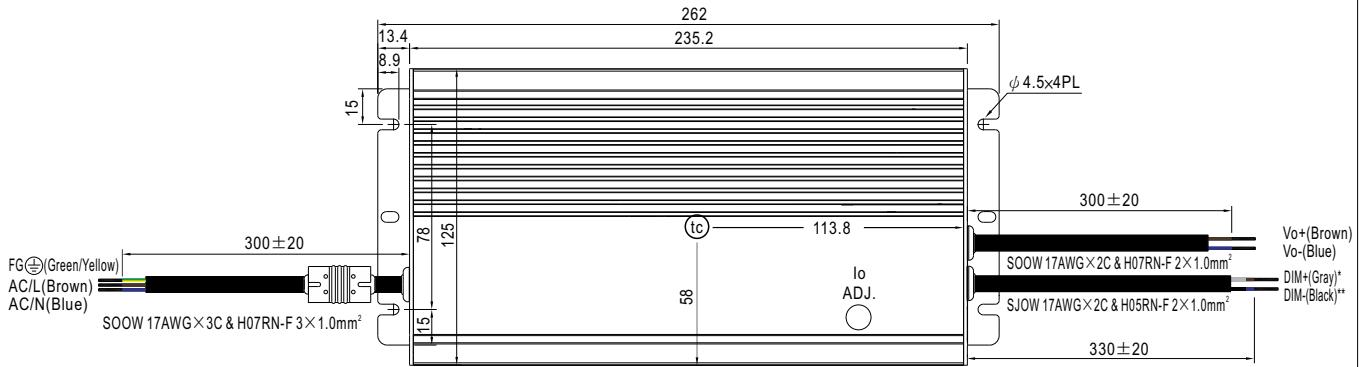

•  $t_c$  : Max. Case Temperature

※Blank-Type

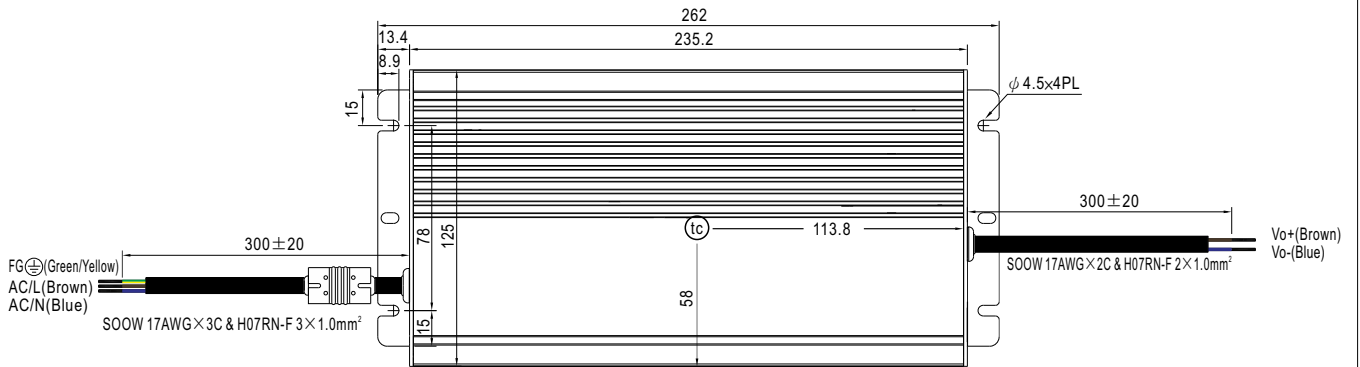

•  $t_c$  : Max. Case Temperature

## MECHANICAL SPECIFICATION

### ※D2-Type

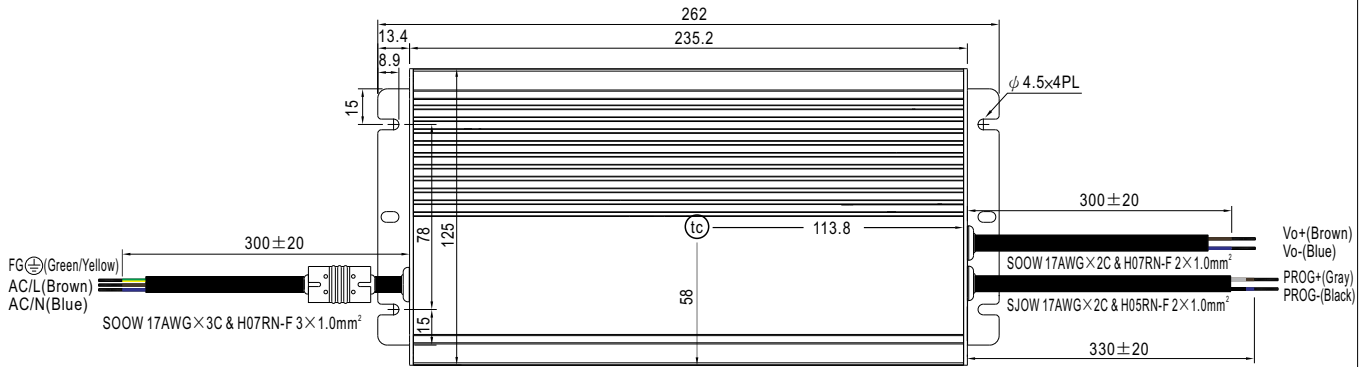

• (tc) : Max. Case Temperature

### ※Dx-Type

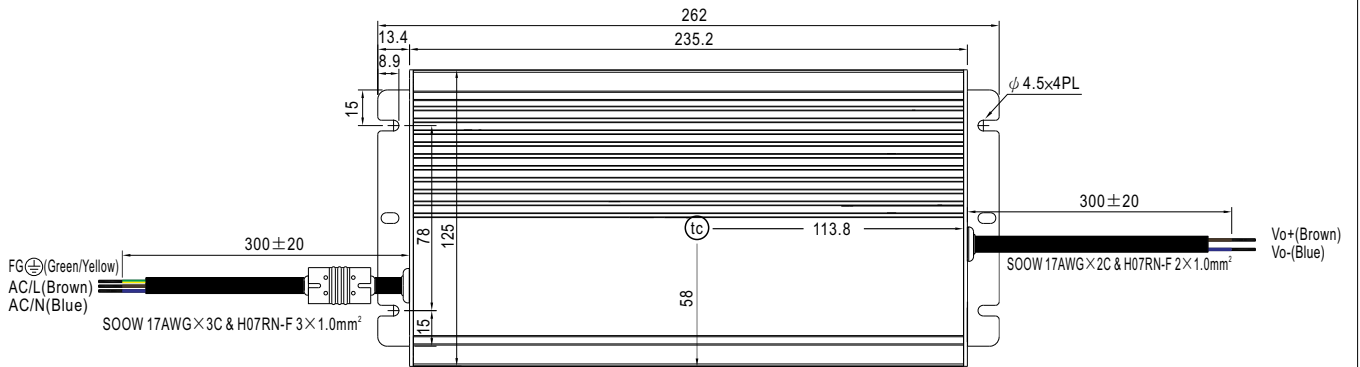

• (tc) : Max. Case Temperature

※DA-Type

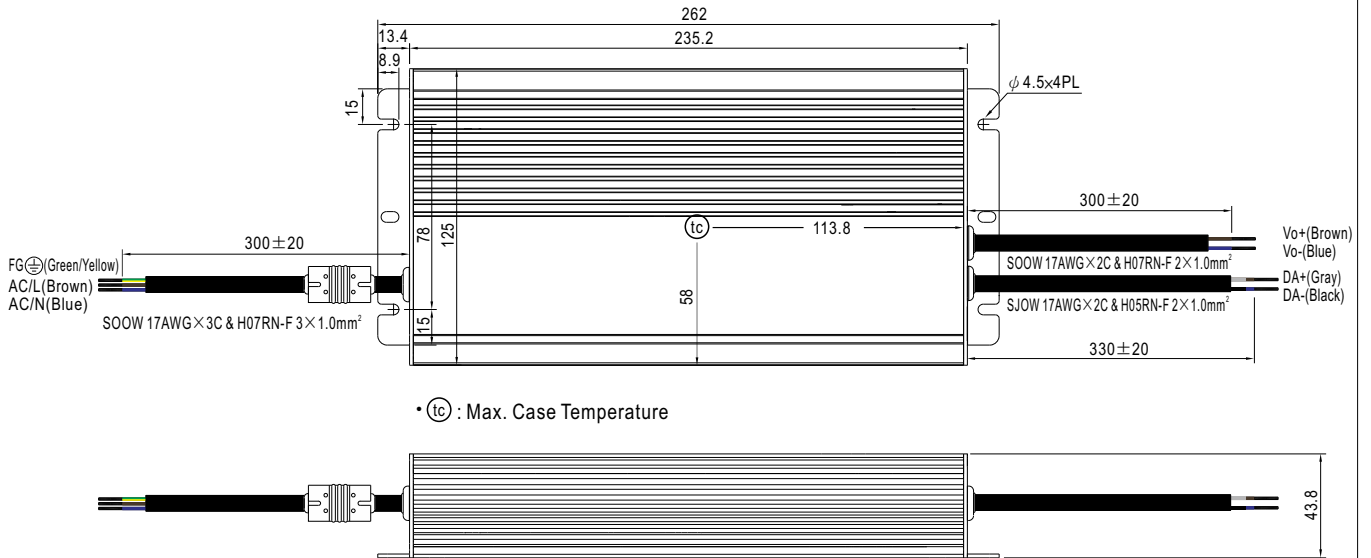

## ■ INSTALLATION MANUAL

Please refer to : <http://www.meanwell.com/manual.html>

## X-ON Electronics

Largest Supplier of Electrical and Electronic Components

*Click to view similar products for [LED Power Supplies](#) category:*

*Click to view products by [Mean Well](#) manufacturer:*

Other Similar products are found below :

[ESS015W-1000-12](#) [EUC-075S105DT](#) [PDA-WIFI](#) [PIFC-K250F](#) [PITB-K222A](#) [ALD-514012PJ134](#) [LB240S24KH](#) [LMH020-SPLC-0000-0000001](#) [79534](#) [79535](#) [EUG-200S210DT](#) [ESS030W-1050-21](#) [ESS030W-0900-32](#) [BPOXL 4-12-035](#) [SLM160W-3.9-40-ZA](#) [ESS010W-0180-42](#) [ESS010W-0350-24](#) [ESS010W-0200-42](#) [PDA080B-1A0G](#) [ESS010W-0500-12](#) [PDA150B-S1A5G](#) [ZPS-20](#) [SLM140W-1.05-130-ZA](#) [ESS040W-1400-27](#) [ESS015W-0700-18](#) [ESS010E-0250-42](#) [EVM120W-2700-42-ECN2](#) [EDC-100S105SV-0007](#) [79278](#) [EUD-150S350DVA](#) [LWA320-C420-ARK-B](#) [50304](#) [HVG-320-36AB](#) [HVG-320-54AB](#) [OT FIT 50/220-240/300 D L](#) [OT FIT 35/220-240/350 D CS L](#) [OT FIT 65/220-240/350 D CS L](#) [ELEMENT 30/220-240/700 S](#) [LC 75W 100-400MA 1-10V LP EXC](#) [LCA 35W 150-700MA ONE4ALL LP PRE](#) [LCA 50W 100-400MA ONE4ALL LP PRE](#) [LCA 50W 350-1050MA ONE4ALL LP PRE](#) [LCA 50W 350-1050MA 2XCH LP PRE](#) [LCI 150/325-1050/300 O4A SL PRE](#) [LCA 75W 100-400MA ONE4ALL LP PRE](#) [LCA 45W 500-1400MA ONE4ALL SC PRE](#) [LC 50W 100-400MA FLEXC LP EXC](#) [LCA 75W 350-1050MA ONE4ALL LP PRE](#) [LC 50W 350-1050MA FLEXC LP EXC](#) [LC 75W 350-1050MA FLEXC LP EXC](#)