



CONNECTORS/ APPLIANCES

MTA, CST-100 II and SL-156 Connectors

Introduction

This catalog has been designed to assist you, our customer, identify products to satisfy your connector needs for printed circuit board headers, mass termination connectors preloaded with contacts, crimp-snap contacts and housings, and card edge connectors with preloaded contacts. The list at right identifies by centerline the types of product available and is meant to be of assistance to you in the product selection process.



IDC
MTA-100



Crimp
CST-100 II



IDC
MTA-156

Introduction and Table of Contents	2, 3
Connector Selection Guide	3

.100 [2.54] Centerline Connectors

MTA-100 IDC Connectors and Headers	4-23
Introduction	4
Wire-to-Board Mateability Guide	5, 6
Connectors—UL94V-2 and UL94V-0	
Closed End with and without Polarizing Tab	7, 8
Feed-Thru with and without Polarizing Tab.....	7, 8
LED Closed End and Feed-Thru—UL94V-2.....	7, 8
Accessories	9, 10
Posted Connectors Mateability Guide	11, 12
MTA-100 Posted Connectors (Wire-to-Wire) UL94V-2	
Closed End.....	13
Feed-Thru	13
Headers—UL94V-0	
Flat—Straight and Right-Angle Posts.....	14
Narrow Flat—Straight and Right-Angle Posts.....	15
Polarized—Straight and Right-Angle Posts.....	16
Friction Lock—Straight and Right-Angle Posts.....	17
Headers with Retention Peg—Straight Posts.....	18
High Profile Headers—Right-Angle Posts.....	19
Polarized—High Temperature, Straight and Right-Angle Posts.....	20
Friction Lock—High Temperature, Straight and Right-Angle Posts	21
Polarized—Surface Mount, Straight.....	22
Friction Lock—Surface Mount, Straight	22
Shrouded—Straight and Right-Angle Posts.....	23
CST-100 II Crimp Contacts, Housings and Shrouded	24, 25

.156 [3.96] Centerline Connectors

MTA-156 IDC Connectors and Headers	26-46
Introduction	26
Wire-to-Board Mateability Guide	27, 28
Connectors—UL94V-2 and UL94V-0	
Closed End with Locking Ramp, with and without Polarizing Tabs.....	29
Closed End without Locking Ramp, with and without Polarizing Tabs	30
Feed-Thru with Locking Ramp, with and without Polarizing Tabs	31
Feed-Thru without Locking Ramp, with and without Polarizing Tabs.....	32
Accessories	33-35
Posted Connectors Mateability Guide	36, 37
MTA-156 Posted Connectors (Wire-to-Wire)—UL94V-2	
Closed End.....	38
Feed-Thru	38
MTA-156 Headers—UL94V-0	
Flat—Straight Posts.....	39
Flat—Right-Angle Posts.....	40
Friction Lock—Straight Posts.....	41
Friction Lock—Right-Angle Posts.....	42
Polarized Lock—Straight Posts.....	43
Polarized Lock—Right-Angle Posts.....	44
Friction Lock—High Temperature, Straight Posts.....	45
Shrouded—Straight and Right-Angle Posts.....	46



**Crimp
SL-156**

Need More Information?

Call Technical Support at the numbers listed on the back of this catalog. Technical Support is staffed with specialists well versed in TE products. They can provide you with:

- Technical support
- Catalogs
- Technical Documents
- Product Samples
- Authorized Distributor Locations

SL-156 Crimp Connectors and Headers	47-51
Wire-to-Board Mateability Guide	47
Wire-to-Board Crimp Contacts and Keying Plugs.....	48
Wire-to-Board Housings—UL94V-0.....	49
Housings with Through Board Latch—UL94V-2.....	50
Housings and Contacts for Large Insulation Diameter (LID) Wire.....	51
MTA Wire Selection and Ribbon Cable Preparation	52
IDC Ribbon Cable	53-56
MTA Wire Termination Flowchart	57
MTA Application Tooling	58-61
Part Number Index	62-64
Global Contacts	65
TE Technical Support	66

CONNECTOR SELECTION GUIDE

Product Name	Centerline	Contact Termination	Wire-to-Wire Options	No. of Positions	Wire Size (AWG)	Wire Insulation Dia. Max.	Current Rating (A)**	Voltage Rating Max. (VAC)	Operating Temp. Range (°C)	UL Flammability	Replacement Contacts	Approvals
.100" Centerline												
MTA-100 IDC Connectors and Headers	.100 2.54	IDC	Planned	2-28	28-22	.060* 1.52	5	250	-55 to +105	V-0 & V-2	Yes	
CST-100 II Contacts and Housings	.100 2.54	Crimp	Planned	2-28	26-22	.065 1.65	4	250	-55 to +105	V-0	Yes	
.156" Centerline												
MTA-156 Connectors and Headers	.156 3.96	IDC	Yes	2-24	16-18	.095* 2.41	7	600	-55 to +105	V-0 & V-2	Yes	
SL-156 Contacts and Housings	.156 3.96	Crimp	No	1-24; 2-10 w/ through board latch	24-18	.105 2.67	10	250	-25 to +105	V-0	Yes	
SL-156 Large Ins. Dia. (LID) Contacts and Housings	.156 3.96	Crimp	No	2-24	24-16	.112 2.84	10	250	-25 to +105	V-0	Yes	

*When terminated one position at a time.

**Current Rating is application dependent.

.100 [2.54] Centerline MTA-100 IDC Connectors and Headers

PRODUCT FACTS

- Connectors and headers for 2 through 28 positions; wire sizes of 22, 24, 26 and 28 AWG [0.4-0.08 mm²]
- Wire-to-Post Connectors preloaded with dual beam contacts
- Connectors and headers, except shrouded headers, are end-to-end stackable
- Connector styles include both closed end and feed thru connectors with locking ramps, with and without polarizing tabs
- Molded ribs on housing do not allow reverse mating
- Posted connectors for 2 through 19 positions
- Connectors preloaded with IDC contacts
- All contacts are slotted for insulation displacement (IDC) terminal technique
- Contacts are lubricated for fretting corrosion protection
- Benefits derived from the MTA-100 system include increased quality and ease of handling such as:
 - One-step assembly
 - No wire stripping
 - No contact damage
 - Reduced wiring errors
 - Simpler tooling
 - Simple maintenance and repair
- Meets the material requirements of Table 23.1 of UL1410 Standards for Television Receiver and Video Products (wire-to post connectors only)
- Recognized under the Component Program of Underwriters Laboratories Inc., File No. E28476 
- Certified by Canadian Standards Association, File No. LR7189 

Technical Documents Product Specification

108-1050 MTA-100 Connectors

Application Specifications

114-1019 MTA-100 Connectors

114-1031 MTA-100 Ribbon Cable Assembly

MTA-100 connectors accept discrete and ribbon cable wire sizes ranging from 22-28 AWG [0.4-0.08 mm²] with maximum insulation outside diameter of .060 [1.52] for terminating single wire and .050



[1.27] for mass termination of wires. Tin plated solid, fused stranded, or stranded (7 strands) wire with PVC insulation can be used on 22-28 AWG [0.4-0.9 mm²] MTA-100 connectors and 19 stranded wire on 22-24 AWG [0.4-0.2 mm²] MTA-100 connectors. Only one wire to be terminated into an IDC contact slot.

The wire-to-post connector housing material is flame retardant thermoplastic, either UL94V-2 or UL94V-0 rated.

A full line of .100 [2.54] centerline headers completes the system. Headers are available with straight or right-angle posts, in flat, polarized or friction lock styles. Headers are available in 2 through 28 positions. Shrouded headers are available in 2 through 14 positions.

Performance Data*

Voltage Rating—250 vac

Current Rating—5 amp max.

Low-Level Resistance—
6 mΩ max. initial

Dielectric Withstanding Voltage—
750 vac/1 min.

Insulation Resistance—
5000 MΩ min. initial

Operating Temperature—
-55° C to +105° C

Note: Refer to page 52 for approved wire listings.

*Refer to the Product Specification for additional electrical, mechanical and environmental performance tests and requirements.

MTA-100 Connector/Header Mateability Guide

This matrix has been prepared to assist you, our customer, in defining the correct mating halves for the MTA-100 header and connector combination. Where a “Y” is indicated the combination is a valid mating pair. Where an “N” is indicated the combination is not acceptable for mating.

Matrix for
Tin Plated
Part Numbers

		Headers																																	
		640452	640453	640454	640455	640456	640457	644456	644457	644486	644488	644694	644695	644803	644861	644874	644875	644876	644877	644892	644893	644894	647047	647048	647050	647051	647106	647166	647502	647531	647609	647623	647532	1744075	
Connectors	640440	Y	Y	Y	Y	Y	Y	Y	Y	Y	Y	Y	Y	Y	Y	Y	Y	Y	N	N	N	Y	Y	Y	Y	Y	Y	Y	Y	Y	Y	Y	Y	Y	
	640441	Y	Y	Y	Y	Y	Y	Y	Y	Y	Y	Y	Y	Y	Y	Y	Y	Y	N	N	N	Y	Y	Y	Y	Y	Y	Y	Y	Y	Y	Y	Y	Y	
	640442	Y	Y	Y	Y	Y	Y	Y	Y	Y	Y	Y	Y	Y	Y	Y	Y	Y	N	N	N	Y	Y	Y	Y	Y	Y	Y	Y	Y	Y	Y	Y	Y	
	640443	Y	Y	Y	Y	Y	Y	Y	Y	Y	Y	Y	Y	Y	Y	Y	Y	Y	N	N	N	Y	Y	Y	Y	Y	Y	Y	Y	Y	Y	Y	Y	Y	
	640468	Y	Y	Y	Y	Y	Y	Y	Y	Y	Y	Y	Y	Y	Y	Y	Y	Y	Y	N	N	N	Y	Y	Y	Y	Y	Y	Y	Y	Y	Y	Y	Y	Y
	640469	Y	Y	Y	Y	Y	Y	Y	Y	Y	Y	Y	Y	Y	Y	Y	Y	Y	Y	N	N	N	Y	Y	Y	Y	Y	Y	Y	Y	Y	Y	Y	Y	Y
	640470	Y	Y	Y	Y	Y	Y	Y	Y	Y	Y	Y	Y	Y	Y	Y	Y	Y	Y	N	N	N	Y	Y	Y	Y	Y	Y	Y	Y	Y	Y	Y	Y	Y
	640471	Y	Y	Y	Y	Y	Y	Y	Y	Y	Y	Y	Y	Y	Y	Y	Y	Y	Y	N	N	N	Y	Y	Y	Y	Y	Y	Y	Y	Y	Y	Y	Y	Y
	640620	Y	Y	Y	Y	Y	Y	Y	Y	Y	Y	Y	Y	Y	Y	Y	Y	Y	Y	N	N	N	Y	Y	Y	Y	Y	Y	Y	Y	Y	Y	Y	Y	Y
	640621	Y	Y	Y	Y	Y	Y	Y	Y	Y	Y	Y	Y	Y	Y	Y	Y	Y	Y	N	N	N	Y	Y	Y	Y	Y	Y	Y	Y	Y	Y	Y	Y	Y
	640622	Y	Y	Y	Y	Y	Y	Y	Y	Y	Y	Y	Y	Y	Y	Y	Y	Y	Y	N	N	N	Y	Y	Y	Y	Y	Y	Y	Y	Y	Y	Y	Y	Y
	640623	Y	Y	Y	Y	Y	Y	Y	Y	Y	Y	Y	Y	Y	Y	Y	Y	Y	Y	N	N	N	Y	Y	Y	Y	Y	Y	Y	Y	Y	Y	Y	Y	Y
	641311	Y	Y	Y	Y	Y	Y	Y	Y	Y	Y	Y	Y	Y	Y	Y	Y	Y	Y	N	N	N	Y	Y	Y	Y	Y	Y	Y	Y	Y	Y	Y	Y	Y
	641312	Y	Y	Y	Y	Y	Y	Y	Y	Y	Y	Y	Y	Y	Y	Y	Y	Y	Y	N	N	N	Y	Y	Y	Y	Y	Y	Y	Y	Y	Y	Y	Y	Y
	641313	Y	Y	Y	Y	Y	Y	Y	Y	Y	Y	Y	Y	Y	Y	Y	Y	Y	Y	N	N	N	Y	Y	Y	Y	Y	Y	Y	Y	Y	Y	Y	Y	Y
	641314	Y	Y	Y	Y	Y	Y	Y	Y	Y	Y	Y	Y	Y	Y	Y	Y	Y	Y	N	N	N	Y	Y	Y	Y	Y	Y	Y	Y	Y	Y	Y	Y	Y
	641534	Y	Y	Y	Y	Y	Y	Y	Y	Y	Y	Y	Y	Y	Y	Y	Y	Y	Y	N	N	N	Y	Y	Y	Y	Y	Y	Y	Y	Y	Y	Y	Y	Y
	641535	Y	Y	Y	Y	Y	Y	Y	Y	Y	Y	Y	Y	Y	Y	Y	Y	Y	Y	N	N	N	Y	Y	Y	Y	Y	Y	Y	Y	Y	Y	Y	Y	Y
	641536	Y	Y	Y	Y	Y	Y	Y	Y	Y	Y	Y	Y	Y	Y	Y	Y	Y	Y	N	N	N	Y	Y	Y	Y	Y	Y	Y	Y	Y	Y	Y	Y	Y
	641537	Y	Y	Y	Y	Y	Y	Y	Y	Y	Y	Y	Y	Y	Y	Y	Y	Y	Y	N	N	N	Y	Y	Y	Y	Y	Y	Y	Y	Y	Y	Y	Y	Y
	641653	Y	Y	Y	Y	Y	Y	Y	Y	Y	Y	Y	Y	Y	Y	Y	Y	Y	Y	N	N	N	Y	Y	Y	Y	Y	Y	Y	Y	Y	Y	Y	Y	Y
	641654	Y	Y	Y	Y	Y	Y	Y	Y	Y	Y	Y	Y	Y	Y	Y	Y	Y	Y	N	N	N	Y	Y	Y	Y	Y	Y	Y	Y	Y	Y	Y	Y	Y
	641655	Y	Y	Y	Y	Y	Y	Y	Y	Y	Y	Y	Y	Y	Y	Y	Y	Y	Y	N	N	N	Y	Y	Y	Y	Y	Y	Y	Y	Y	Y	Y	Y	Y
	641656	Y	Y	Y	Y	Y	Y	Y	Y	Y	Y	Y	Y	Y	Y	Y	Y	Y	Y	N	N	N	Y	Y	Y	Y	Y	Y	Y	Y	Y	Y	Y	Y	Y
	643498	Y	Y	Y	Y	Y	Y	Y	Y	Y	Y	Y	Y	Y	Y	Y	Y	Y	Y	N	N	N	Y	Y	Y	Y	Y	Y	Y	Y	Y	Y	Y	Y	Y
	643813	Y	Y	Y	Y	Y	Y	Y	Y	Y	Y	Y	Y	Y	Y	Y	Y	Y	Y	N	N	N	Y	Y	Y	Y	Y	Y	Y	Y	Y	Y	Y	Y	Y
	643814	Y	Y	Y	Y	Y	Y	Y	Y	Y	Y	Y	Y	Y	Y	Y	Y	Y	Y	N	N	N	Y	Y	Y	Y	Y	Y	Y	Y	Y	Y	Y	Y	Y
	643815	Y	Y	Y	Y	Y	Y	Y	Y	Y	Y	Y	Y	Y	Y	Y	Y	Y	Y	N	N	N	Y	Y	Y	Y	Y	Y	Y	Y	Y	Y	Y	Y	Y
	643816	Y	Y	Y	Y	Y	Y	Y	Y	Y	Y	Y	Y	Y	Y	Y	Y	Y	Y	N	N	N	Y	Y	Y	Y	Y	Y	Y	Y	Y	Y	Y	Y	Y
	643828	Y	Y	Y	Y	Y	Y	Y	Y	Y	Y	Y	Y	Y	Y	Y	Y	Y	Y	N	N	N	Y	Y	Y	Y	Y	Y	Y	Y	Y	Y	Y	Y	Y
	644083	Y	Y	Y	Y	Y	Y	Y	Y	Y	Y	Y	Y	Y	Y	Y	Y	Y	Y	N	N	N	Y	Y	Y	Y	Y	Y	Y	Y	Y	Y	Y	Y	Y
	644312	Y	Y	Y	Y	Y	Y	Y	Y	Y	Y	Y	Y	Y	Y	Y	Y	Y	Y	N	N	N	Y	Y	Y	Y	Y	Y	Y	Y	Y	Y	Y	Y	Y
	644313	Y	Y	Y	Y	Y	Y	Y	Y	Y	Y	Y	Y	Y	Y	Y	Y	Y	Y	N	N	N	Y	Y	Y	Y	Y	Y	Y	Y	Y	Y	Y	Y	Y
	644497	Y	Y	Y	Y	Y	Y	Y	Y	Y	Y	Y	Y	Y	Y	Y	Y	Y	Y	N	N	N	Y	Y	Y	Y	Y	Y	Y	Y	Y	Y	Y	Y	Y
	644511	Y	Y	Y	Y	Y	Y	Y	Y	Y	Y	Y	Y	Y	Y	Y	Y	Y	Y	N	N	N	Y	Y	Y	Y	Y	Y	Y	Y	Y	Y	Y	Y	Y
	644512	Y	Y	Y	Y	Y	Y	Y	Y	Y	Y	Y	Y	Y	Y	Y	Y	Y	Y	N	N	N	Y	Y	Y	Y	Y	Y	Y	Y	Y	Y	Y	Y	Y
	644513	Y	Y	Y	Y	Y	Y	Y	Y	Y	Y	Y	Y	Y	Y	Y	Y	Y	Y	N	N	N	Y	Y	Y	Y	Y	Y	Y	Y	Y	Y	Y	Y	Y
	644514	Y	Y	Y	Y	Y	Y	Y	Y	Y	Y	Y	Y	Y	Y	Y	Y	Y	Y	N	N	N	Y	Y	Y	Y	Y	Y	Y	Y	Y	Y	Y	Y	Y
	644540	Y	Y	Y	Y	Y	Y	Y	Y	Y	Y	Y	Y	Y	Y	Y	Y	Y	Y	N	N	N	Y	Y	Y	Y	Y	Y	Y	Y	Y	Y	Y	Y	Y
	644563	Y	Y	Y	Y	Y	Y	Y	Y	Y	Y	Y	Y	Y	Y	Y	Y	Y	Y	N	N	N	Y	Y	Y	Y	Y	Y	Y	Y	Y	Y	Y	Y	Y
644564	Y	Y	Y	Y	Y	Y	Y	Y	Y	Y	Y	Y	Y	Y	Y	Y	Y	Y	N	N	N	Y	Y	Y	Y	Y	Y	Y	Y	Y	Y	Y	Y	Y	
644565	Y	Y	Y	Y	Y	Y	Y	Y	Y	Y	Y	Y	Y	Y	Y	Y	Y	Y	N	N	N	Y	Y	Y	Y	Y	Y	Y	Y	Y	Y	Y	Y	Y	
644574	Y	Y	Y	Y	Y	Y	Y	Y	Y	Y	Y	Y	Y	Y	Y	Y	Y	Y	N	N	N	Y	Y	Y	Y	Y	Y	Y	Y	Y	Y	Y	Y	Y	
644575	Y	Y	Y	Y	Y	Y	Y	Y	Y	Y	Y	Y	Y	Y	Y	Y	Y	Y	N	N	N	Y	Y	Y	Y	Y	Y	Y	Y	Y	Y	Y	Y	Y	
644576	Y	Y	Y	Y	Y	Y	Y	Y	Y	Y	Y	Y	Y	Y	Y	Y	Y	Y	N	N	N	Y	Y	Y	Y	Y	Y	Y	Y	Y	Y	Y	Y	Y	
644577	Y	Y	Y	Y	Y	Y	Y	Y	Y	Y	Y	Y	Y	Y	Y	Y	Y	Y	N	N	N	Y	Y	Y	Y	Y	Y	Y	Y	Y	Y	Y	Y	Y	
644578	Y	Y	Y	Y	Y	Y	Y	Y	Y	Y	Y	Y	Y	Y	Y	Y	Y	Y	N	N	N	Y	Y	Y	Y	Y	Y	Y	Y	Y	Y	Y	Y	Y	
644579	Y	Y	Y	Y	Y	Y	Y	Y	Y	Y	Y	Y	Y	Y	Y	Y	Y	Y	N	N	N	Y	Y	Y	Y	Y	Y	Y	Y	Y	Y	Y	Y	Y	
644795	Y	Y	Y	Y	Y	Y	Y	Y	Y	Y	Y	Y	Y	Y	Y	Y	Y	Y	N	N	N	Y	Y	Y	Y	Y	Y	Y	Y	Y	Y	Y	Y	Y	
*1375820	Y	Y	Y	Y	Y	Y	Y	N	N	Y	Y	N	N	Y	Y	Y	Y	Y	N	N	N	Y	Y	Y	Y	Y	Y	Y	Y	Y	Y	Y	Y	Y	

*Select contact plating to match header plating.

MTA-100 Connector/Header Mateability Guide (continued)

This matrix has been prepared to assist you, our customer, in defining the correct mating halves for the MTA-100 header and connector combination. Where a “Y” is indicated the combination is a valid mating pair. Where an “N” is indicated the combination is not acceptable for mating.

Matrix for
.000030
[0.00076]
Gold Plated
Part Numbers

		Headers																									
		641211	641212	641213	641214	641215	641216	644487	644489	644884	644885	644886	644887	644896	644897	644898	647108	647109	647114	647116	647117	647168	647626	647624	647534	1744047	1744163
Connectors	641237	Y	Y	Y	Y	Y	Y	Y	Y	Y	Y	Y	Y	N	N	N	Y	Y	Y	Y	Y	Y	Y	Y	Y	Y	Y
	641238	Y	Y	Y	Y	Y	Y	Y	Y	Y	Y	Y	Y	N	N	N	Y	Y	Y	Y	Y	Y	Y	Y	Y	Y	Y
	641239	Y	Y	Y	Y	Y	Y	Y	Y	Y	Y	Y	Y	N	N	N	Y	Y	Y	Y	Y	Y	Y	Y	Y	Y	Y
	641240	Y	Y	Y	Y	Y	Y	Y	Y	Y	Y	Y	Y	N	N	N	Y	Y	Y	Y	Y	Y	Y	Y	Y	Y	Y
	641241	Y	Y	Y	Y	Y	Y	Y	Y	Y	Y	Y	Y	N	N	N	Y	Y	Y	Y	Y	Y	Y	Y	Y	Y	Y
	641242	Y	Y	Y	Y	Y	Y	Y	Y	Y	Y	Y	Y	N	N	N	Y	Y	Y	Y	Y	Y	Y	Y	Y	Y	Y
	641243	Y	Y	Y	Y	Y	Y	Y	Y	Y	Y	Y	Y	N	N	N	Y	Y	Y	Y	Y	Y	Y	Y	Y	Y	Y
	641244	Y	Y	Y	Y	Y	Y	Y	Y	Y	Y	Y	Y	N	N	N	Y	Y	Y	Y	Y	Y	Y	Y	Y	Y	Y
	644020	Y	Y	Y	Y	Y	Y	Y	Y	Y	Y	Y	Y	N	N	N	Y	Y	Y	Y	Y	Y	Y	Y	Y	Y	Y
	644042	Y	Y	Y	Y	Y	Y	Y	Y	Y	Y	Y	Y	N	N	N	Y	Y	Y	Y	Y	Y	Y	Y	Y	Y	Y
	644043	Y	Y	Y	Y	Y	Y	Y	Y	Y	Y	Y	Y	N	N	N	Y	Y	Y	Y	Y	Y	Y	Y	Y	Y	Y
	644044	Y	Y	Y	Y	Y	Y	Y	Y	Y	Y	Y	Y	N	N	N	Y	Y	Y	Y	Y	Y	Y	Y	Y	Y	Y
	644702	Y	Y	Y	Y	Y	Y	Y	Y	Y	Y	Y	Y	N	N	N	Y	Y	Y	Y	Y	Y	Y	Y	Y	Y	Y
	644726	Y	Y	Y	Y	Y	Y	Y	Y	Y	Y	Y	Y	N	N	N	Y	Y	Y	Y	Y	Y	Y	Y	Y	Y	Y
	*1375820	Y	Y	Y	Y	Y	Y	N	N	Y	Y	Y	Y	Y	Y	Y	Y	Y	Y	Y	Y	Y	Y	Y	Y	Y	Y

*Select contact plating to match header plating.

Matrix for
.000015
[0.00038]
Gold Plated
Part Numbers

		Headers																									
		641122	641123	641124	641125	641126	641127	644888	644889	644890	644891	647075	647076	647078	647079	647107	647167	647467	647625	647627	647533	1744074					
Connectors	641190	Y	Y	Y	Y	Y	Y	Y	Y	Y	Y	Y	Y	Y	Y	Y	Y	Y	Y	Y	Y	Y	Y	Y	Y		
	641191	Y	Y	Y	Y	Y	Y	Y	Y	Y	Y	Y	Y	Y	Y	Y	Y	Y	Y	Y	Y	Y	Y	Y	Y	Y	
	641192	Y	Y	Y	Y	Y	Y	Y	Y	Y	Y	Y	Y	Y	Y	Y	Y	Y	Y	Y	Y	Y	Y	Y	Y	Y	
	641193	Y	Y	Y	Y	Y	Y	Y	Y	Y	Y	Y	Y	Y	Y	Y	Y	Y	Y	Y	Y	Y	Y	Y	Y	Y	
	641198	Y	Y	Y	Y	Y	Y	Y	Y	Y	Y	Y	Y	Y	Y	Y	Y	Y	Y	Y	Y	Y	Y	Y	Y	Y	
	641199	Y	Y	Y	Y	Y	Y	Y	Y	Y	Y	Y	Y	Y	Y	Y	Y	Y	Y	Y	Y	Y	Y	Y	Y	Y	
	641200	Y	Y	Y	Y	Y	Y	Y	Y	Y	Y	Y	Y	Y	Y	Y	Y	Y	Y	Y	Y	Y	Y	Y	Y	Y	
	641201	Y	Y	Y	Y	Y	Y	Y	Y	Y	Y	Y	Y	Y	Y	Y	Y	Y	Y	Y	Y	Y	Y	Y	Y	Y	
	644038	Y	Y	Y	Y	Y	Y	Y	Y	Y	Y	Y	Y	Y	Y	Y	Y	Y	Y	Y	Y	Y	Y	Y	Y	Y	
	644040	Y	Y	Y	Y	Y	Y	Y	Y	Y	Y	Y	Y	Y	Y	Y	Y	Y	Y	Y	Y	Y	Y	Y	Y	Y	
	647477	Y	Y	Y	Y	Y	Y	Y	Y	Y	Y	Y	Y	Y	Y	Y	Y	Y	Y	Y	Y	Y	Y	Y	Y	Y	
	647480	Y	Y	Y	Y	Y	Y	Y	Y	Y	Y	Y	Y	Y	Y	Y	Y	Y	Y	Y	Y	Y	Y	Y	Y	Y	
	*1375820	N	N	N	N	N	N	N	N	N	N	N	N	N	N	N	N	N	N	N	N	N	N	N	N	N	N
	1744020	Y	Y	Y	Y	Y	Y	Y	Y	Y	Y	Y	Y	Y	Y	Y	Y	Y	Y	Y	Y	Y	Y	Y	Y	Y	

*Select contact plating to match header plating.

MTA-100 IDC Connectors—Closed End and Feed-Thru

Material and Finish

Housing—UL94V-2 rated, nylon, see below for color; or UL94V-0 rated, nylon, black

Contacts—Phosphor bronze, post tin plated, .000030 [0.00076] or .000015 [0.00038] post gold-plated over nickel

Color Coding by Wire Size for UL94V-2 Connectors

28 AWG—Green

26 AWG—Blue

24 AWG—White

22 AWG—Red

All wire sizes in UL94V-0—Black

For mateability options, see matrix on pages 5 and 6.

For mating half visuals, see pages 13 thru 23.

Notes:

1. Refer to pages 52-56 for approved wire listing.
2. For strain reliefs and dust covers, see page 9.
3. For keying plugs, see page 10.
4. Other circuit sizes are available upon request. Minimums may apply.
5. Connector circuits can be molded closed for keying purposes. Minimums may apply.
6. Where no part numbers appear in the chart, parts can be made available upon request. Minimums may apply.
7. To determine connector overall length (dim. A), multiply .100 x the number of circuits. Example: .100 x 10 circuits equals 1.000 inch [25.4 mm].

Closed End Connectors

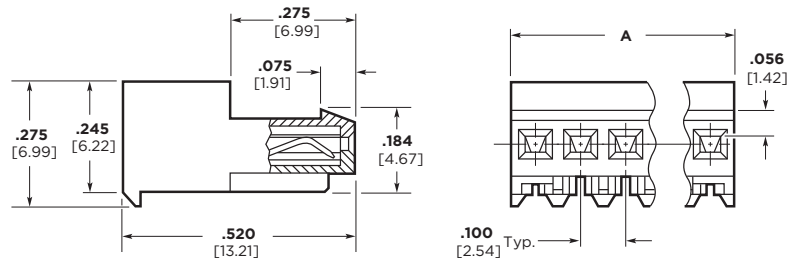

Without Polarizing Tabs

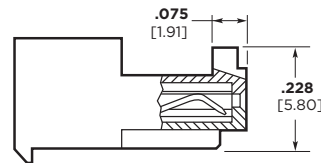

With Polarizing Tabs

Feed-Thru Connectors

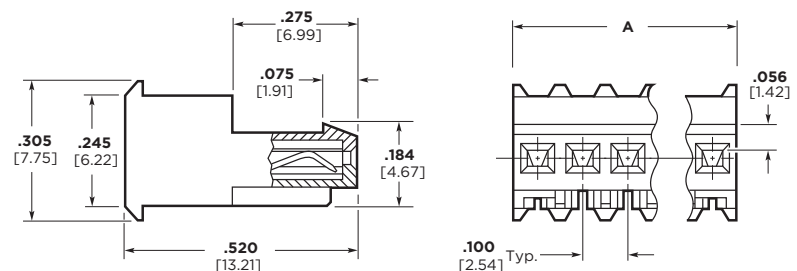

Without Polarizing Tabs

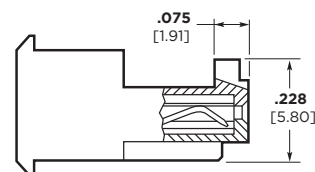

With Polarizing Tabs

MTA-100 IDC Connectors—Closed End and Feed-Thru (continued)

Connector Ordering Information

The “Base Part Numbers” Chart at right shows the base part number, and their RoHS (Restrictions on Certain Hazardous Substances) Compliant (lead free) equivalent available for the described connectors.

Prefixes and suffixes are determined by the number of circuit positions in the connector. For example, the complete part number for a 10-position closed end connector without polarizing tabs for 22 AWG wire would be:

Base number **640440** plus prefix-and-suffix
4- -- -0

The correct ordering number is
4-640440-0

All part numbers are the RoHS equivalent version. Example:

No. of Pos.	Lead Free RoHS Prefix/Suffix
2	3-640440-2
3	3-640440-3
4	3-640440-4
5	3-640440-5
6	3-640440-6
7	3-640440-7
8	3-640440-8
9	3-640440-9
10	4-640440-0
11	4-640440-1
12	4-640440-2
13	4-640440-3
14	4-640440-4
15	4-640440-5
16	4-640440-6
17	4-640440-7
18	4-640440-8
19	4-640440-9
20	5-640440-0
21	5-640440-1
22	5-640440-2
23	5-640440-3
24	5-640440-4
25	5-640440-5
26	5-640440-6
27	5-640440-7
28	5-640440-8

Note: All RoHS equivalent part numbers may not be available upon catalog release. If the number you need is not available, please contact Product Engineering to expedite your request.

Base Part Numbers

Connector Type & Wire Size	Closed End				Feed-Thru			
	Without Tabs		With Tabs		Without Tabs		With Tabs	
	Connector Part Nos.	RoHS Equiv.	Connector Part Nos.	RoHS Equiv.	Connector Part Nos.	RoHS Equiv.	Connector Part Nos.	RoHS Equiv.
Standard UL94V-2, Tin Plated								
22 AWG 0.3-0.4 mm ²	640440	32-58	643813	32-58	640620	32-58	644540 ¹	32-45
24 AWG 0.2 mm ²	640441	32-58	643814	32-58	640621	32-58	644563 ¹	32-54
26 AWG 0.12-0.15 mm ²	640442	32-58	643815	32-58	640622	32-58	644564 ¹	32-45
28 AWG 0.08-0.09 mm ²	640443	32-58	643816	32-58	640623	32-58	644565 ¹	32-45
Tape Mounted on Reel UL94V-2, Tin Plated								
22 AWG 0.3-0.4 mm ²	640468	32-58	644511	42-68	641311	32-58	—	—
24 AWG 0.2 mm ²	640469	32-58	644512	32-58	641312	32-58	—	—
26 AWG 0.12-0.15 mm ²	640470	32-58	644513	32-58	641313	32-58	—	—
28 AWG 0.08-0.09 mm ²	640471	32-58	644514	32-58	641314	32-58	—	—
Standard UL94V-2, .000030 [0.00076] Gold Plated								
22 AWG 0.3-0.4 mm ²	641237	32-58	644042	32-58	641241	32-58	644702 ¹	32-45
24 AWG 0.2 mm ²	641238	32-58	644020	32-58	641242	32-58	—	—
26 AWG 0.12-0.15 mm ²	641239	32-58	644043 ¹	32-44	641243	32-58	644726 ¹	32-45
28 AWG 0.8-0.9 mm ²	641240	32-58	644044 ¹	32-44	641244	32-58	—	—
Standard UL94V-2, .000015 [0.00038] Gold Plated								
22 AWG 0.3-0.4 mm ²	641190	32-58	644038 ¹	32-44	641198	32-58	647477	32-46
24 AWG 0.2 mm ²	641191	32-58	1744020 ¹	32-44	641199	32-58	—	—
26 AWG 0.12-0.15 mm ²	641192	32-58	644040 ¹	32-44	641200	32-58	647480	32-43
28 AWG 0.08-0.09 mm ²	641193	32-58	—	—	641201	32-58	—	—
LED*, UL94V-2, Tin Plated (See Note 1)								
22 AWG 0.3-0.4 mm ²	641534	32-33	—	—	641653	32-33	—	—
24 AWG 0.2 mm ²	641535	32-33	644795	32-33	641654	32-33	—	—
26 AWG 0.12-0.15 mm ²	641536	32-33	—	—	641655	32-33	—	—
28 AWG 0.08-0.09 mm ²	641537	32-33	—	—	641656	32-33	—	—
Standard UL94V-0, Tin Plated (Gold is available, minimums may apply.) (Black in color)								
22 AWG 0.3-0.4 mm ²	643498 ¹	32-45	644083 ¹	32-45	644575 ¹	32-45	644578 ¹	32-45
24 AWG 0.2 mm ²	644574 ¹	32-45	644312 ¹	32-45	644576 ¹	32-45	644579 ¹	32-45
26 AWG 0.12-0.15 mm ²	643828 ¹	32-45	644313 ¹	32-45	644577 ¹	32-45	644497 ¹	32-45

*LED connectors are designed to mate with .014-.020 [0.36-0.51] diameter posts or square leads.

¹ Other circuit sizes are available upon request. Minimums may apply.

² Tape mounted.

Note: Blocked circuit configurations are available. Contact product engineer or product manager for details. Minimums may apply.

MTA-100 IDC Connector Accessories

Covers

Material (RoHS Compliant)

Strain Relief Cover—UL94V-2 rated, nylon, white

Dust Covers—UL94V-0 rated, polyester, white

Cover Ordering Information

The “Base Part Numbers” Chart at right shows the base part number and number of circuits available for the described cover.

Prefixes and suffixes are determined by the number of circuit positions in the cover. For example, the complete part number for a 10-position closed end strain relief cover would be:

Base number **643075** plus
prefix-and-suffix
1- -0

The correct ordering number is
1-643075-0

Closed End Strain Relief Covers

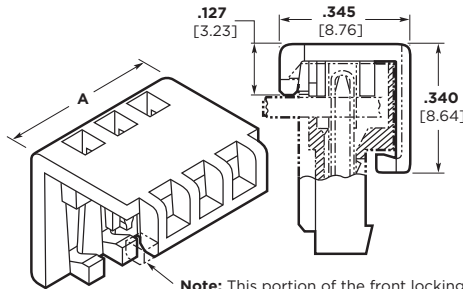

Closed End Dust Covers

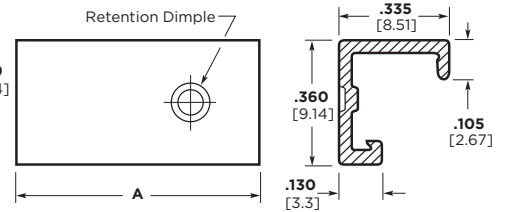

Feed-Thru Strain Relief Covers



Feed-Thru Dust Covers

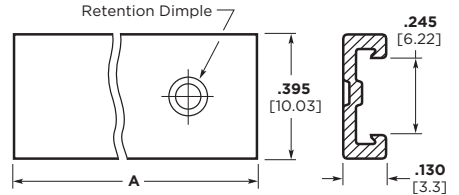

Base Part Numbers

Closed End				Feed-Thru			
Strain Relief Covers		Dust Covers		Strain Relief Covers		Dust Covers	
Cover Part Nos.	No. of Circuits	Cover Part Nos.	No. of Circuits	Cover Part Nos.	No. of Circuits	Cover Part Nos.	No. of Circuits
643075	2-28	640550	2-28	643077	2-28	640642	3-28

Cover Length

No. of Circuits	Dim. A	Prefix/Suffix	No. of Circuits	Dim. A	Prefix/Suffix	No. of Circuits	Dim. A	Prefix/Suffix	No. of Circuits	Dim. A	Prefix/Suffix
2	.200 5.08	-2	9	.900 22.86	-9	16	1.600 40.64	1- -6	23	2.300 58.42	2- -3
3	.300 7.62	-3	10	1.00 25.4	1- -0	17	1.700 43.18	1- -7	24	2.400 60.96	2- -4
4	.400 10.16	-4	11	1.100 27.94	1- -1	18	1.800 45.72	1- -8	25	2.500 63.5	2- -5
5	.500 12.7	-5	12	1.200 30.48	1- -2	19	1.900 48.26	1- -9	26	2.600 66.04	2- -6
6	.600 15.24	-6	13	1.300 33.02	1- -3	20	2.000 50.8	2- -0	27	2.700 68.58	2- -7
7	.700 17.78	-7	14	1.400 35.56	1- -4	21	2.100 53.34	2- -1	28	2.800 71.12	2- -8
8	.800 20.32	-8	15	1.500 38.1	1- -5	22	2.200 55.88	2- -2			

MTA-100 IDC Connector Accessories (continued)

Keying Plug with Carrier Strip (10 plugs per strip) Part No. 641994-1

Material (RoHS Compliant)

UL94V-2 rated, nylon, natural color



Note: Removal of contact is not necessary when using keying plug.

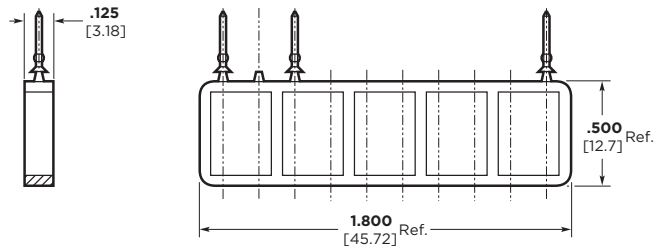

Replacement IDC Contacts

Material and Finish

Phosphor bronze, post tin plated;
.000030 [0.00076] or .000015
[0.00038] post gold plated over nickel

Note: TE does not recommend terminating an MTA contact more than one time. Use replacement contacts when required for field repairs or wire changes.

Wire Size		Part Numbers			
AWG	mm ²	Standard Tin Plated	.000030 [0.00076] Gold Plated	.000015 [0.00038] Gold Plated	LED Tin Plated
22	0.3-0.4	640636-3	641186-4	641186-3	641643-2
24	0.2	640637-3	641187-4	641187-3	641644-2
26	0.12-0.15	640638-3	641188-4	641188-3	641645-2
28	0.08-0.09	640639-3	641189-4	641189-3	641646-2



Crimp Snap-In Contacts

Material and Finish

Phosphor bronze, tin plated.



Wire Size		Part Nos.	
AWG	mm ²	Loose Piece*	Strip**
26-22	0.12-0.4	640709-2	640708-2

*Hand Tool No. 59836-1 (IS 408-6527)

**Applicator No. 466747-1 (IS 408-8040)

Special applications for crimp snap-in contacts are:

1. Double wire per contact
2. Coax or shielded wire
3. Mixed wire size in same connector

Note: Only one crimp snap-in contact per connector.

MTA-100 Connector/Connector Mateability Guide

This matrix has been prepared to assist you, our customer, in defining the correct mating halves for the MTA-100 posted connector and connector combination. Where a “Y” is indicated the combination is a valid mating pair. Where an “N” is indicated the combination is not acceptable for mating.

**Matrix for
Tin Plated
Part Numbers**

		Posted Connectors							
		647000	647001	647002	647003	647004	647005	647006	647007
Connectors	640440	Y	Y	Y	Y	Y	Y	Y	Y
	640441	Y	Y	Y	Y	Y	Y	Y	Y
	640442	Y	Y	Y	Y	Y	Y	Y	Y
	640443	Y	Y	Y	Y	Y	Y	Y	Y
	640468	Y	Y	Y	Y	Y	Y	Y	Y
	640469	Y	Y	Y	Y	Y	Y	Y	Y
	640470	Y	Y	Y	Y	Y	Y	Y	Y
	640471	Y	Y	Y	Y	Y	Y	Y	Y
	640620	Y	Y	Y	Y	Y	Y	Y	Y
	640621	Y	Y	Y	Y	Y	Y	Y	Y
	640622	Y	Y	Y	Y	Y	Y	Y	Y
	640623	Y	Y	Y	Y	Y	Y	Y	Y
	641311	Y	Y	Y	Y	Y	Y	Y	Y
	641312	Y	Y	Y	Y	Y	Y	Y	Y
	641313	Y	Y	Y	Y	Y	Y	Y	Y
	641314	Y	Y	Y	Y	Y	Y	Y	Y
	641534	Y	Y	Y	Y	Y	Y	Y	Y
	641535	Y	Y	Y	Y	Y	Y	Y	Y
	641536	Y	Y	Y	Y	Y	Y	Y	Y
	641537	Y	Y	Y	Y	Y	Y	Y	Y
	641653	Y	Y	Y	Y	Y	Y	Y	Y
	641654	Y	Y	Y	Y	Y	Y	Y	Y
	641655	Y	Y	Y	Y	Y	Y	Y	Y
	641656	Y	Y	Y	Y	Y	Y	Y	Y
	643498	Y	Y	Y	Y	Y	Y	Y	Y
	643813	Y*	Y*	Y*	Y*	Y*	Y*	Y*	Y*
	643814	Y*	Y*	Y*	Y*	Y*	Y*	Y*	Y*
	643815	Y*	Y*	Y*	Y*	Y*	Y*	Y*	Y*
	643816	Y*	Y*	Y*	Y*	Y*	Y*	Y*	Y*
	643828	Y	Y	Y	Y	Y	Y	Y	Y
	644083	Y*	Y*	Y*	Y*	Y*	Y*	Y*	Y*
	644312	Y*	Y*	Y*	Y*	Y*	Y*	Y*	Y*
	644313	Y*	Y*	Y*	Y*	Y*	Y*	Y*	Y*
	644497	Y*	Y*	Y*	Y*	Y*	Y*	Y*	Y*
	644511	Y*	Y*	Y*	Y*	Y*	Y*	Y*	Y*
	644512	Y*	Y*	Y*	Y*	Y*	Y*	Y*	Y*
	644513	Y*	Y*	Y*	Y*	Y*	Y*	Y*	Y*
	644514	Y*	Y*	Y*	Y*	Y*	Y*	Y*	Y*
	644540	Y*	Y*	Y*	Y*	Y*	Y*	Y*	Y*
	644563	Y*	Y*	Y*	Y*	Y*	Y*	Y*	Y*
	644564	Y*	Y*	Y*	Y*	Y*	Y*	Y*	Y*
	644565	Y*	Y*	Y*	Y*	Y*	Y*	Y*	Y*
	644574	Y	Y	Y	Y	Y	Y	Y	Y
	644575	Y	Y	Y	Y	Y	Y	Y	Y
	644576	Y	Y	Y	Y	Y	Y	Y	Y
644577	Y	Y	Y	Y	Y	Y	Y	Y	
644578	Y*	Y*	Y*	Y*	Y*	Y*	Y*	Y*	
644579	Y*	Y*	Y*	Y*	Y*	Y*	Y*	Y*	
644795	Y*	Y*	Y*	Y*	Y*	Y*	Y*	Y*	
1375820	N	N	N	N	N	N	N	N	

*2 & 3 position MTA-100 Posted Connectors can not mate with MTA-100 connectors with polarizing tabs.

MTA-100 Connector/Connector Mateability Guide (continued)

This matrix has been prepared to assist you, our customer, in defining the correct mating halves for the MTA-100 posted connector and connector combination. Where a “Y” is indicated the combination is a valid mating pair. Where an “N” is indicated the combination is not acceptable for mating.

**Matrix for
.000030
[0.00076]
Gold Plated
Part Numbers**

		Posted Connectors							
		647008	647009	647010	647011	647012	647013	647014	647015
Connectors	641237	Y	Y	Y	Y	Y	Y	Y	Y
	641238	Y	Y	Y	Y	Y	Y	Y	Y
	641239	Y	Y	Y	Y	Y	Y	Y	Y
	641240	Y	Y	Y	Y	Y	Y	Y	Y
	641241	Y	Y	Y	Y	Y	Y	Y	Y
	641242	Y	Y	Y	Y	Y	Y	Y	Y
	641243	Y	Y	Y	Y	Y	Y	Y	Y
	641244	Y	Y	Y	Y	Y	Y	Y	Y
	644020	Y*	Y*	Y*	Y*	Y*	Y*	Y*	Y*
	644042	Y*	Y*	Y*	Y*	Y*	Y*	Y*	Y*
	644043	Y*	Y*	Y*	Y*	Y*	Y*	Y*	Y*
	644044	Y*	Y*	Y*	Y*	Y*	Y*	Y*	Y*
	644702	Y*	Y*	Y*	Y*	Y*	Y*	Y*	Y*
	644726	Y*	Y*	Y*	Y*	Y*	Y*	Y*	Y*
	1375820	N	N	N	N	N	N	N	N

*2 & 3 position MTA-100 Posted Connectors can not mate with MTA-100 connectors with polarizing tabs.

**Matrix for
.000015
[0.00038]
Gold Plated
Part Numbers**

		Posted Connectors							
		647008	647009	647010	647011	647012	647013	647014	647015
Connectors	641190	Y	Y	Y	Y	Y	Y	Y	Y
	641191	Y	Y	Y	Y	Y	Y	Y	Y
	641192	Y	Y	Y	Y	Y	Y	Y	Y
	641193	Y	Y	Y	Y	Y	Y	Y	Y
	641198	Y	Y	Y	Y	Y	Y	Y	Y
	641199	Y	Y	Y	Y	Y	Y	Y	Y
	641200	Y	Y	Y	Y	Y	Y	Y	Y
	641201	Y	Y	Y	Y	Y	Y	Y	Y
	644038	Y*	Y*	Y*	Y*	Y*	Y*	Y*	Y*
	644040	Y*	Y*	Y*	Y*	Y*	Y*	Y*	Y*
	647477	Y*	Y*	Y*	Y*	Y*	Y*	Y*	Y*
	644726	Y*	Y*	Y*	Y*	Y*	Y*	Y*	Y*
	647480	Y*	Y*	Y*	Y*	Y*	Y*	Y*	Y*
	1375820	N	N	N	N	N	N	N	N
	1744020	Y	Y	Y	Y	Y	Y	Y	Y

*2 & 3 position MTA-100 Posted Connectors can not mate with MTA-100 connectors with polarizing tabs.

MTA-100 IDC Posted Connectors (Wire-to-Wire)—Closed End, Feed-Thru

Material and Finish

Housing—UL94V-2 rated, nylon, see chart for color

Contacts—Copper alloy, post tin or gold plated over nickel (see chart)

- Note:**
1. Mating half visuals — pages 7 & 8.
 2. Use feed thru strain relief covers & feed thru dust covers (if needed)—page 9.
 3. Approved wire listing—pages 52-56.



Closed End



Feed-Thru



Connector Ordering Information

The “Base Part Numbers” Chart at right shows the base part number.

Prefixes and suffixes are determined by the number of circuit positions in the connector. For example, the complete part number for a 12-position closed end connector for 22 AWG wire would be:

Base number **647000** plus prefix-and-suffix
4- -2

The correct ordering number is
4-647000-2

All part numbers are the RoHS equivalent version. Example:

No. of Pos.	Lead Free RoHS Prefix/Suffix
2	3-647000-2
	thru
19	4-647000-9

See page 8 for an explanation of RoHS lead free equivalents.

Note: All RoHS equivalent part numbers may not be available upon catalog release. If the number you need is not available, please contact Product Engineering to expedite your request.

Color Coding by Wire Size for UL94V-2 Connectors

- 22 AWG**—Red
- 24 AWG**—White
- 26 AWG**—Blue
- 28 AWG**—Green

Performance Data

- Voltage Rating**—250 vac
- Current Rating**—5 amp max.
- Low-Level Resistance**—6 mΩ max. initial
- Dielectric Withstanding Voltage**—750 vac/1 min.
- Insulation Resistance**—5000 MΩ min. initial
- Operating Temperature**—-55° C to +105° C

Base Part Numbers

Connector Type & Wire Size	Closed End Connector		Feed-Thru Connector	
	Part Nos.	RoHS Equiv.	Part Nos.	No. of Circuits
Standard UL 94V-2, Tin Plated				
22 AWG 0.3–0.4 mm ²	647000	32-49 ¹	647004	— ²
24 AWG 0.2 mm ²	647001	32-49 ¹	647005	— ²
26 AWG 0.12–0.15 mm ²	647002	32-49 ¹	647006	— ²
28 AWG 0.08–0.09 mm ²	647003	32-49 ¹	647007	— ²
Standard UL 94V-2, .000030 [0.00076] Gold Plated				
22 AWG 0.3–0.4 mm ²	647008	32-49 ¹	647012	— ²
24 AWG 0.2 mm ²	647009	32-49 ¹	647013	— ²
26 AWG 0.12–0.15 mm ²	647010	32-49 ¹	647014	— ²
28 AWG 0.08–0.09 mm ²	647011	32-49 ¹	647015	— ²
Standard UL 94V-2, .000015 [0.00038] Gold Plated				
22 AWG 0.3–0.4 mm ²	647016	32-49 ¹	647020	— ²
24 AWG 0.2 mm ²	647017	32-49 ¹	647021	— ²
26 AWG 0.12–0.15 mm ²	647018	32-49 ¹	647022	— ²
28 AWG 0.08–0.09 mm ²	647019	32-49 ¹	647023	— ²

¹ 2 and 3 position MTA-100 Posted Connectors (Closed End) **can not mate** with MTA-100 connectors with polarizing tabs.
² Parts may be manufactured upon request. Minimums may apply. Contact product engineer or product manager for details.

No. of Circuits	Dim.		No. of Circuits	Dim.		No. of Circuits	Dim.		No. of Circuits	Dim.	
	A	B		A	B		A	B		A	B
2	.300 [7.62]	.227 [5.77]	6	.700 [17.78]	.627 [15.93]	10	1.100 [27.94]	1.027 [26.09]	14	1.500 [38.10]	1.427 [36.25]
3	.400 [10.16]	.327 [8.31]	7	.800 [20.32]	.727 [18.47]	11	1.200 [30.48]	1.127 [28.63]	15	1.600 [40.64]	1.527 [38.79]
4	.500 [12.70]	.427 [10.85]	8	.900 [22.86]	.827 [21.01]	12	1.300 [33.02]	1.227 [31.17]	16	1.700 [43.18]	1.627 [41.33]
5	.600 [15.24]	.527 [13.39]	9	1.000 [25.40]	.927 [23.55]	13	1.400 [35.56]	1.327 [33.71]	17	1.800 [45.72]	1.727 [43.87]
									18	1.900 [48.26]	1.827 [46.41]
									19	2.000 [50.80]	1.927 [48.95]

Technical Documents

- Product Specification**
108-1050-1 MTA-100 Posted Connector
- Application Specification**
114-1019 MTA-100 Connectors

Replacement IDC Contacts

Material and Finish
Contacts—Copper alloy, post tin or gold plated over nickel

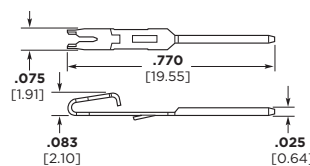

Wire Size AWG mm ²	Part Numbers	Part Numbers	
		Tin Plated	.000030 [0.00076] Gold Plated
22 0.3-0.4	3-647030-1	3-647030-2	
24 0.2	3-647031-1	3-647031-2	
26 0.12-0.15	3-647032-1	3-647032-2	
28 0.8-0.9	3-647033-1	3-647033-2	

MTA-100 Flat Headers—Straight and Right-Angle

Material and Finish

Housing—UL94V-0 rated, polyester, white

Contacts—Copper alloy, tin plated, .000030 [0.00076] or .000015 [0.00038] gold over nickel

Note:

1. Post(s) can be omitted for keying purposes. Specify the desired post(s) to be omitted using the figure to identify Post No. 1.
2. Gold headers are duplex plated, gold on mating end of post and tin on the solder tail.
3. To determine header overall length (dim. A) multiply .100 x the number of posts. Example: .100 x 10 posts equals 1.000 inch [25.4 mm].

For mateability options, see matrix on pages 5 and 6.

For mating half visuals, see pages 7, 8 and 24.

Header Ordering Information

The “Base Part Numbers” Chart at right shows the base part number.

Prefixes and suffixes are determined by the number of post positions in the header. For example, the complete part number for a 10-position header with straight posts would be:

Base number **641211** plus prefix-and-suffix
4- -- 0

The correct ordering number is
4-641211-0

All part numbers are the RoHS equivalent version. Example:

No. of Pos.	Lead Free RoHS Prefix/Suffix
2	3-641211-2
	thru
28	5-641211-8

See page 8 for an explanation of RoHS lead free equivalents.

Note: All RoHS equivalent part numbers may not be available upon catalog release. If the number you need is not available, please contact Product Engineering to expedite your request.

Note: Select load headers (omitted pin headers) are available upon request. Please contact product engineer or product manager for details.

Straight Post (.025 [0.64] Square)

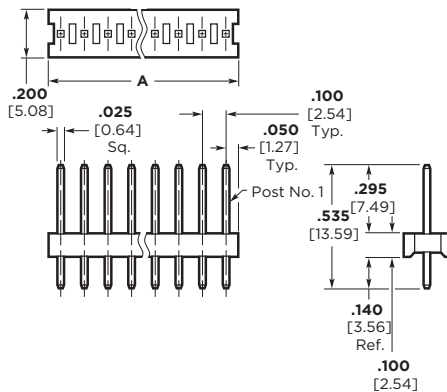

Right-Angle Post (.025 [0.64] Square)



X = .120 [3.05] min., .240 [6.1] max. when mated with MTA-100 Connector.
X = .120 [3.05] min., when mated with CST-100 II Connector.

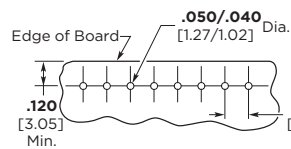

Recommended Mounting Hole Pattern for .062 [1.57] Thk. PC Board

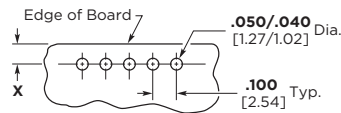

Recommended Mounting Hole Pattern for .062 [1.57] Thk. PC Board

Note: Consult Product Drawing for details on placing headers onto PC boards.

Base Part Numbers

Straight Posts		Right-Angle Posts	
Header Part Nos.	No. of Post RoHS Equiv.	Header Part Nos.	No. of Posts/RoHS Equiv.
Standard UL94V-0, Tin Plated			
640452	2-28	640453	2-28
Standard UL94V-0, .000030 [0.00076] Gold Plated			
641211	2-28 32-58	641212	2-28 32-58
Standard UL94V-0, .000015 [0.00038] Gold Plated			
641122	2-28 32-58	641123	2-28 32-58

MTA-100 Narrow Flat Headers—Straight and Right-Angle

Material and Finish

Housing—UL94V-0 rated, polyester, white

Contacts—Copper alloy, tin plated,
.000030 [0.00076] or .000015
[0.00038] gold over nickel

Notes:

1. Post(s) can be omitted for keying purposes. Specify the desired post(s) to be omitted using the figure to identify Post No. 1.
2. Headers without retentive legs are suitable for breakaway application.
3. 2 or 3 retentive leg(s) per header, depending upon number of positions.
4. Gold headers are duplex plated, gold on mating end of post and tin on the solder tail.
5. To determine header overall length (dim. A) multiply .100 x the number of posts minus (-) .012. Example: .100 x 10 posts - .012 = .988 inches [25.1 mm].

For mateability options, see matrix on pages 5 and 6.

For mating half visuals, see pages 7, 8 and 24.

Connector Ordering Information

The “Base Part Numbers” Chart at right shows the base part number.

Prefixes and suffixes are determined by the number of post positions in the header. For example, the complete part number for a 10-position header with straight posts and without retentive legs would be:

Base number **644456** plus
prefix-and-suffix
4- -0

The correct ordering number is
4-644456-0

All part numbers are the RoHS equivalent version. Example:

No. of Pos.	Lead Free RoHS Prefix/Suffix
2	3-644456-2
thru	
28	5-644456-8

See page 8 for an explanation of RoHS lead free equivalents.

Note: All RoHS equivalent part numbers may not be available upon catalog release. If the number you need is not available, please contact Product Engineering to expedite your request.

Note: Select load headers (omitted pin headers) are available upon request. Please contact product engineer or product manager for details.

Straight Post (.025 [0.64] Square)

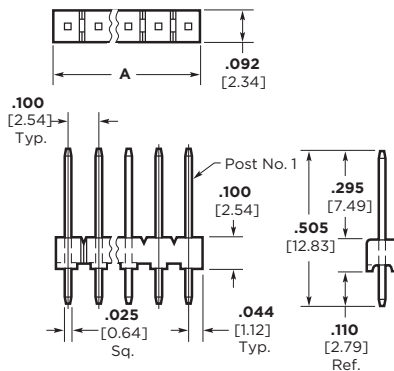

Right-Angle Post (.025 [0.64] Square)

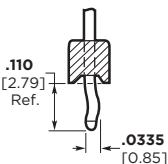

Straight and Right-Angle Post with Retentive Legs

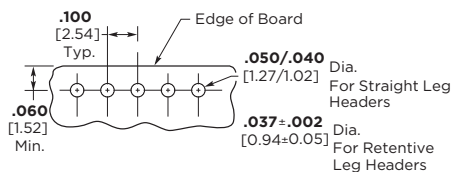

Recommended Mounting Hole Pattern for .062 [1.57] Thk. PC Board

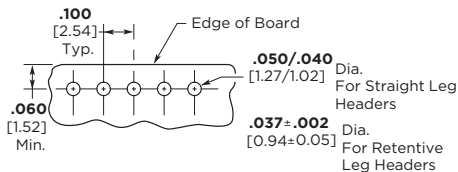

Recommended Mounting Hole Pattern for .062 [1.57] Thk. PC Board

Note: Consult Product Drawing for details on placing headers onto PC boards.

Base Part Numbers

Straight Posts				Right-Angle Posts			
Without Retentive Legs		With Retentive Legs		Without Retentive Legs		With Retentive Legs	
Header Part Nos.	RoHS Equiv.	Header Part Nos.	RoHS Equiv.	Header Part Nos.	RoHS Equiv.	Header Part Nos.	RoHS Equiv.
Standard UL94V-0, Tin Plated							
644456	32-58	644695	32-58	644457	32-58	644694	32-58
Standard UL94V-0, .000030 [0.00076] Gold Plated							
644884	2-28	644886	2-28	644885	2-28	644887	2-28
Standard UL94V-0, .000015 [0.00038] Gold Plated							
644888	2-28	644890	2-28	644889	2-28	644891	2-28

High temperature product available. Please contact Sales Engineer or Product Information Center.

MTA-100 Polarized Headers—Straight and Right-Angle

Material and Finish

Housing—UL94V-0 rated, polyester, white

Contacts—Copper alloy, tin plated, .000030 [0.00076] or .000015 [0.00038] gold over nickel

- Note:**
1. Post(s) can be omitted for keying purposes. Specify the desired post(s) to be omitted using the figure to identify Post No. 1.
 2. Gold headers are duplex plated, gold on mating end of post and tin on the solder tail.
 3. All posts on retentive leg headers are bent.
 4. To determine header overall length (dim. A) multiply .100 x the number of posts. Example: .100 x 10 posts equals 1.000 inch [25.4 mm].

For mateability options, see matrix on pages 5 and 6.

For mating half visuals, see pages 7, 8 and 24.

Connector Ordering Information

The “Base Part Numbers” Chart at right shows the base part number.

Prefixes and suffixes are determined by the number of post positions in the header. For example, the complete part number for a 10-position header with straight posts would be:

Base number **641213** plus prefix-and-suffix **4- - -0**

The correct ordering number is **4-641213-0**

All part numbers are the RoHS equivalent version. Example:

No. of Pos.	Lead Free RoHS Prefix/Suffix
2	3-641213-2
	thru
28	5-641213-8

See page 8 for an explanation of RoHS lead free equivalents.

Note: All RoHS equivalent part numbers may not be available upon catalog release. If the number you need is not available, please contact Product Engineering to expedite your request.

Note: Select load headers (omitted pin headers) are available upon request. Please contact product engineer or product manager for details.

Straight Post (.025 [0.64] Square)

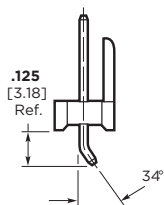
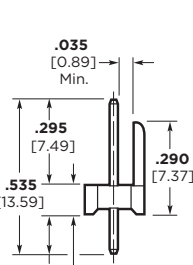
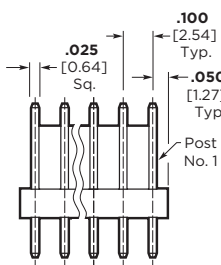
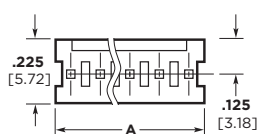

Retentive Leg

Right-Angle Post (.025 [0.64] Square)

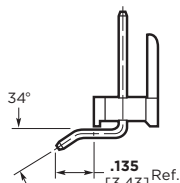
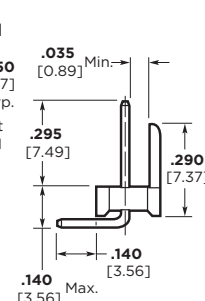
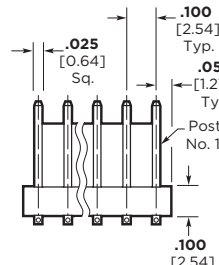
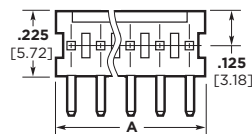

Retentive Leg

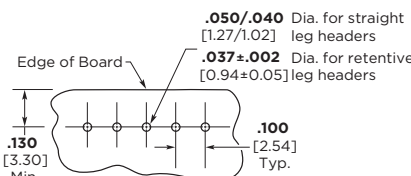

Recommended Mounting Hole Pattern for .062 [1.57] Thk. PC Board

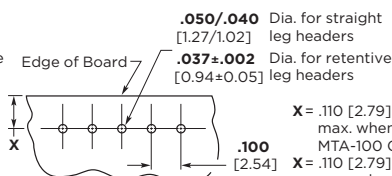

Recommended Mounting Hole Pattern for .062 [1.57] Thk. PC Board

X = .110 [2.79] min., .160 [4.06] max. when mated with MTA-100 Connector.
X = .110 [2.79] min., .120 [3.05] max. when mated with CST-100 II Connector.

Note: Consult Product Drawing for details on placing headers onto PC boards.

Base Part Numbers

Straight Posts				Right-Angle Posts			
Without Retentive Legs		With Retentive Legs		Without Retentive Legs		With Retentive Legs	
Header Part Nos.	RoHS Equiv.	Header Part Nos.	RoHS Equiv.	Header Part Nos.	RoHS Equiv.	Header Part Nos.	RoHS Equiv.
Standard UL94V-0, Tin Plated							
640454	2-28	644876	2-28	640455	2-28	644877	2-28
Standard UL94V-0, .000030 [0.00076] Gold Plated							
641213	32-58	—	—	641214	32-58	—	—
Standard UL94V-0, .000015 [0.00038] Gold Plated							
641124	32-58	—	—	641125	32-58	—	—

MTA-100 Friction Lock Headers—Straight and Right-Angle

Material and Finish

Housing—UL94V-0 rated, polyester, white

Contacts—Copper alloy, tin plated, .000030 [0.00076] or .000015 [0.00038] gold over nickel

- Note:**
1. Post(s) can be omitted for keying purposes. Specify the desired post(s) to be omitted using the figure to identify Post No. 1.
 2. Gold headers are duplex plated, gold on mating end of post and tin on the solder tail.
 3. All posts on retentive leg headers are bent.
 4. To determine header overall length (dim. A) multiply .100 x the number of posts. Example: .100 x 10 posts equals 1.000 inch [25.4 mm].

For mateability options, see matrix on pages 5 and 6.

For mating half visuals, see pages 7, 8 and 24.

Header Ordering Information

The “Base Part Numbers” Chart at right shows the base part number.

Prefixes and suffixes are determined by the number of post positions in the header. For example, the complete part number for a 10-position header with straight posts would be:

Base number **641215** plus prefix-and-suffix **4- -0**

The correct ordering number is **4-641215-0**

All part numbers are the RoHS equivalent version. Example:

No. of Pos.	Standard Prefix/Suffix	Lead Free RoHS Prefix/Suffix
2	641215-2	3-641215-2
thru		
28	2-641215-8	5-641215-8

See page 8 for an explanation of RoHS lead free equivalents.

Note: All RoHS equivalent part numbers may not be available upon catalog release. If the number you need is not available, please contact Product Engineering to expedite your request.

Note: Select load headers (omitted pin headers) are available upon request. Please contact product engineer or product manager for details.

Straight Post (.025 [0.64] Square)

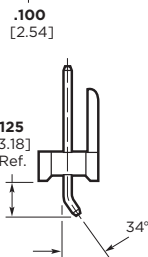
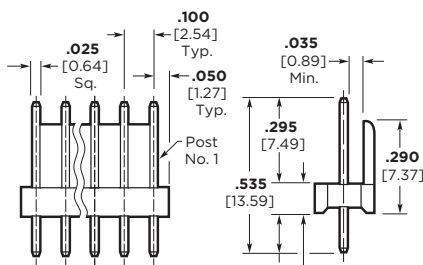

Retentive Leg

Right-Angle Post (.025 [0.64] Square)

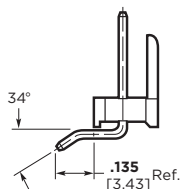
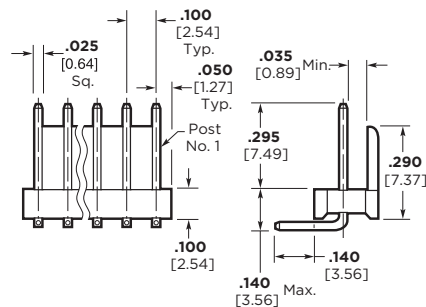
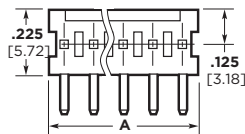

Retentive Leg



Recommended Mounting Hole Pattern for .062 [1.57] Thk. PC Board

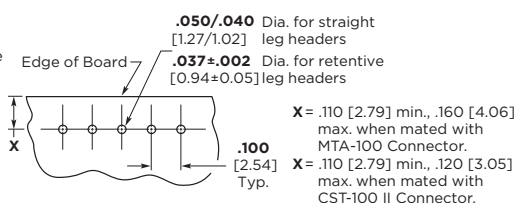

Recommended Mounting Hole Pattern for .062 [1.57] Thk. PC Board

Note: Consult Product Drawing for details on placing headers onto PC boards.

Base Part Numbers

Straight Posts				Right-Angle Posts			
Without Retentive Legs		With Retentive Legs		Without Retentive Legs		With Retentive Legs	
Header Part Nos.	RoHS Equiv.	Header Part Nos.	RoHS Equiv.	Header Part Nos.	RoHS Equiv.	Header Part Nos.	RoHS Equiv.
Standard UL94V-0, Tin Plated							
640456	2-28	644874	2-28	640457	2-28	644875	2-28
Standard UL94V-0, .000030 [0.00076] Gold Plated							
641215	32-58	—	—	641216	32-58	—	—
Standard UL94V-0, .000015 [0.00038] Gold Plated							
641126	32-58	—	—	641127	32-58	—	—

MTA-100 Headers with Retention Peg—Straight

Material and Finish

Housing—UL94V-0 rated, thermoplastic, black

Contacts—Copper alloy, tin plated, .000030 [0.00076] or .000015 [0.00038] gold over nickel

- Note:** 1. Post(s) can be omitted for keying purposes. Specify the desired post(s) to be omitted using the figure to identify Post No. 1.
 2. Gold headers are duplex plated, gold on mating end of post and tin on the solder tail.
 3. To determine header overall length (dim. A) multiply .100 x the number of posts. Example: .100 x 10 posts equals 1.000 inch [25.4 mm].

For mateability options, see matrix on pages 5 and 6.

For mating half visuals, see pages 7, 8 and 24.

Header Ordering Information

The “Base Part Numbers” Chart at right shows the base part number.

Prefixes and suffixes are determined by the number of post positions in the header. For example, the complete part number for a 10-position header with straight posts would be:

Base number **647609** plus
 prefix-and-suffix
4 - - 0

The correct ordering number is
4-647609-0

All part numbers are the RoHS equivalent version. Example:

No. of Pos.	Standard Prefix/Suffix	Lead Free RoHS Prefix/Suffix
2	647609-2	3-647609-2
3	647609-3	3-647609-3
4	647609-4	3-647609-4
5	647609-5	3-647609-5
6	647609-6	3-647609-6
7	647609-7	3-647609-7
8	647609-8	3-647609-8
9	647609-9	3-647609-9
10	1-647609-0	4-647609-0
11	1-647609-1	4-647609-1
12	1-647609-2	4-647609-2

Note: All RoHS equivalent part numbers may not be available upon catalog release. If the number you need is not available, please contact Product Engineering to expedite your request.

Friction Lock



Polarized

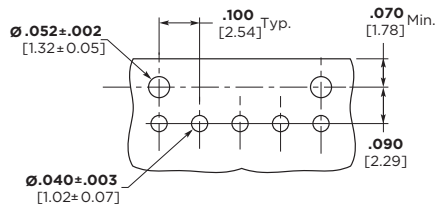
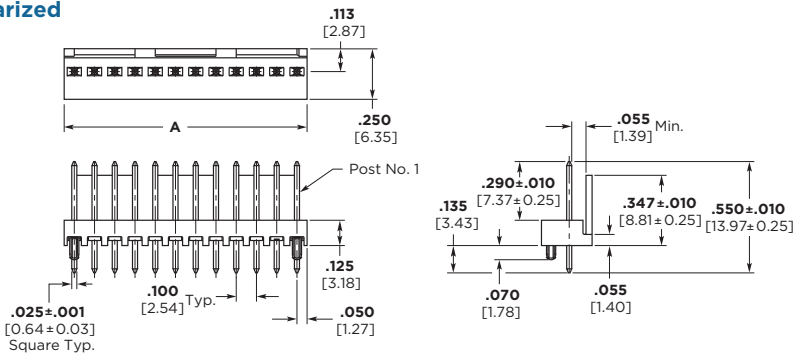

Recommended Mounting Hole Pattern for .062 [1.57] Thk. PC Board

Note: Consult Product Drawing for details on placing headers onto PC boards.

Base Part Numbers

Friction Lock		Polarized	
Header Part Nos.	RoHS Equiv.	Header Part Nos.	RoHS Equiv.
Standard UL94V-0, Tin Plated			
647609	32-42	647623	32-42
Standard UL94V-0, .000030 [0.00076] Gold Plated			
647626	32-42	647624	32-42
Standard UL94V-0, .000015 [0.00038] Gold Plated			
647627	32-42	647625	32-42

Note: Select lead headers (omitted pin headers) are available upon request. Please contact product engineer or product manager for details.

MTA-100 High Profile Headers—Right-Angle

Material and Finish

Housing—UL94V-0 rated, thermoplastic, black

Contacts—Copper alloy, tin plated, .000030 [0.00076] or .000015 [0.00038] gold over nickel

- Note:**
1. Post(s) can be omitted for keying purposes. Specify the desired post(s) to be omitted using the figure to identify Post No. 1.
 2. Gold headers are duplex plated, gold on mating end of post and tin on the solder tail.
 3. To determine header overall length (dim. A) multiply .100 x the number of posts. Example: .100 x 10 posts equals 1.000 inch [25.4 mm].
 4. This product can be mounted in the middle of the PC Board as shown in the PCB layout.

For mateability options, see matrix on pages 5 and 6.

For mating half visuals, see pages 7, 8 and 24.

Header Ordering Information

The “Base Part Numbers” Chart at right shows the base part number.

Prefixes and suffixes are determined by the number of post positions in the header. For example, the complete part number for a 10-position header with right-angle posts would be:

Base number **647630** plus
prefix-and-suffix
4- -0

The correct ordering number is
4-647630-0

All part numbers are the RoHS equivalent version. Example:

No. of Pos.	Lead Free RoHS Prefix/Suffix
2	3-647630-2
3	3-647630-3
4	3-647630-4
5	3-647630-5
6	3-647630-6
7	3-647630-7
8	3-647630-8
9	3-647630-9
10	4-647630-0
11	4-647630-1
12	4-647630-2

Note: All RoHS equivalent part numbers may not be available upon catalog release. If the number you need is not available, please contact Product Engineering to expedite your request.

Friction Lock Right-Angle Post (.025 [0.64] Square)

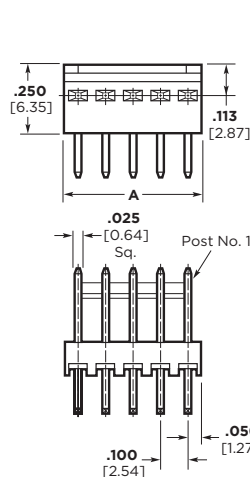

Polarized Right-Angle Post (.025 [0.64] Square)

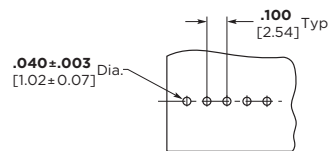
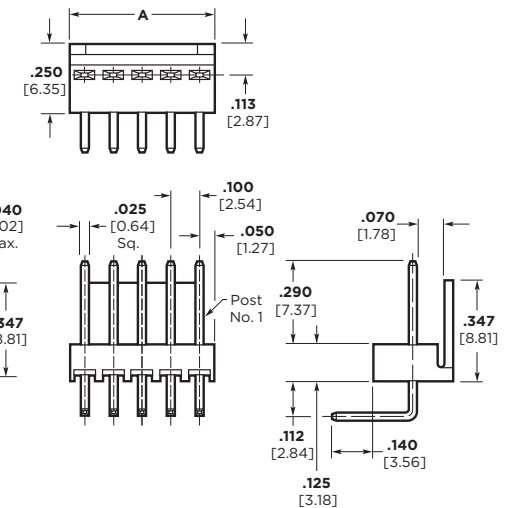

Recommended Mounting Hole Pattern for .062 [1.57] Thk. PC Board

Note: Consult Product Drawing for details on placing headers onto PC boards.

Base Part Numbers

Friction Lock Right-Angle Posts		Polarized Right-Angle Posts	
Header Part Nos.	RoHS Equiv.	Header Part Nos.	RoHS Equiv.
Standard UL94V-0, Tin Plated			
647630	32-42	647651	32-42
Standard UL94V-0, .000030 [0.00076] Gold Plated			
647629	32-42	647653	32-42
Standard UL94V-0, .000015 [0.00038] Gold Plated			
647628	32-42	647652	32-42

Note: Select load headers (omitted pin headers) are available upon request. Please contact product engineer or product manager for details.

MTA-100 Polarized High Temperature Headers—Straight and Right-Angle

Material and Finish

Housing—

2-12 Position—UL94V-0 rated, nylon, black
 13-18 Position—UL94V-0 rated, LCP, black

Posts—Copper alloy, tin plated,
 .000030 [0.00076] or .000015
 [0.00038] gold over nickel

Note:

1. Post(s) can be omitted for keying purposes.
 Specify the desired post(s) to be omitted using the figure to identify Post No. 1.
2. Gold headers are duplex plated, gold on mating end of post and tin on the solder tail.
3. To determine header overall length (dim. A) multiply .100 x the number of posts. Example: .100 x 10 posts equals 1.000 inch [25.4 mm].

For mateability options, see matrix on pages 5 and 6.

For mating half visuals, see pages 7, 8 and 24.

Header Ordering Information

The “Base Part Numbers” Chart at right shows the base part number.

Prefixes and suffixes are determined by the number of post positions in the header. For example, the complete part number for a 10-position header with straight posts would be:

Base number **647047** plus
 prefix-and-suffix
4- - -0

The correct ordering number is
4-647047-0

All part numbers are the RoHS equivalent version. Example:

No. of Pos.	Lead Free RoHS Prefix/Suffix
2	3-647047-2
	thru
12	4-647047-2
13	NA
	thru
18	NA

See page 8 for an explanation of RoHS lead free equivalents.

Note: All RoHS equivalent part numbers may not be available upon catalog release. If the number you need is not available, please contact Product Engineering to expedite your request.

For use with Infrared Reflow Process

Maximum Temperature Rating: 2-12 Position: 280°C
 13-18 Position: 235°C

Straight Post (.025 [0.64] Square)

Right-Angle Post (.025 [0.64] Square)



Note: Consult Product Drawing for details on placing headers onto PC boards.

Recommended Mounting Hole Pattern for .062 [1.57] Thick PC Board

Base Part Numbers

Straight Posts		Straight Posts (Tube Loaded)		Right-Angle Posts	
Header Part Nos.	RoHS Equiv.	Header Part Nos.	RoHS Equiv.	Header Part Nos.	RoHS Equiv.
Standard UL94V-0, Tin Plated					
647047	32-42	647298	32-42	647048	32-42
Standard UL94V-0, .000030 [0.00076] Gold Plated					
647109	32-42	647300	32-42	647114	32-42
Standard UL94V-0, .000015 [0.00038] Gold Plated					
647075	32-42	647299	32-42	647076	32-42

Note: Select load headers (omitted pin headers) are available upon request. Please contact product engineer or product manager for details.

MTA-100 Friction Lock High Temperature Headers—Straight and Right-Angle

Material and Finish

Housing—

2-12 Position—UL94V-0 rated, nylon, black
 13-18 Position—UL94V-0 rated, LCP, black

Posts—Copper alloy, tin plated,
 .000030 [0.00076] or .000015
 [0.00038] gold over nickel

- Note:** 1. Post(s) can be omitted for keying purposes. Specify the desired post(s) to be omitted using the figure to identify Post No. 1.
 2. Gold headers are duplex plated, gold on mating end of post and tin on the solder tail.
 3. To determine header overall length (dim. A) multiply .100 x the number of posts. Example: 100 x 10 posts equals 1.000 inch [25.4 mm].

For mateability options, see matrix on pages 5 and 6.

For mating half visuals, see pages 7, 8 and 24.

Header Ordering Information

The “Base Part Numbers” Chart at right shows the base part number.

Prefixes and suffixes are determined by the number of post positions in the header. For example, the complete part number for a 10-position header with straight posts would be:

Base number **647050** plus
 prefix-and-suffix
4- -- 0

The correct ordering number is
4-647050-0

All part numbers are the RoHS equivalent version. Example:

No. of Pos.	Standard Prefix/Suffix	Lead Free RoHS Prefix/Suffix
2	647050-2	3-647050-2
thru		
12	1-647050-2	4-647050-2
13	1-647050-3	NA
thru		
18	1-647050-8	NA

See page 8 for an explanation of RoHS lead free equivalents.

Note: All RoHS equivalent part numbers may not be available upon catalog release. If the number you need is not available, please contact Product Engineering to expedite your request.

For use with Infrared Reflow Process

Maximum Temperature Rating: 2-12 Position: 280°C
 13-18 Position: 235°C

Straight Post (.025 [0.64] Square)

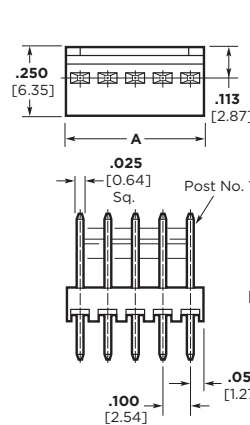

Right-Angle Post (.025 [0.64] Square)

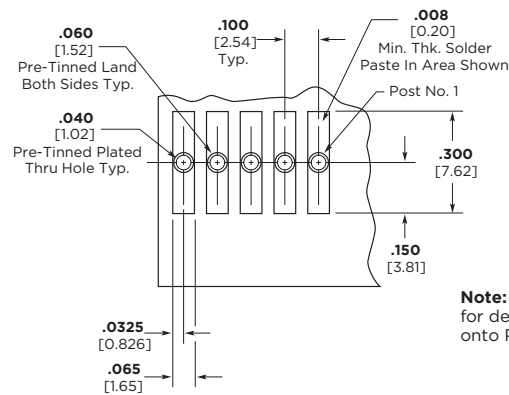
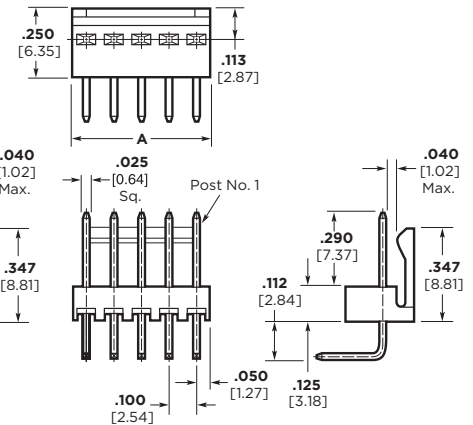

Note: Consult Product Drawing for details on placing headers onto PC boards.

Recommended Mounting Hole Pattern for .062 [1.57] Thick PC Board

Base Part Numbers

Straight Posts		Straight Posts (Tube Loaded)		Right-Angle Posts	
Header Part Nos.	RoHS Equiv.	Header Part Nos.	RoHS Equiv.	Header Part Nos.	RoHS Equiv.
Standard UL94V-0, Tin Plated					
647050	32-42	647295	32-42	647051	32-42
Standard UL94V-0, .000030 [0.00076] Gold Plated					
647116	32-42	647297	32-42	647117	32-42
Standard UL94V-0, .000015 [0.00038] Gold Plated					
647078	32-42	647296	32-42	647079	32-42

Note: Select load headers (omitted pin headers) are available upon request. Please contact product engineer or product manager for details.

MTA-100 Polarized and Friction Lock Surface Mount Headers—Straight

Material and Finish

Housing—

2-12 Position—UL94V-0 rated, nylon, black
 13-18 Position—UL94V-0 rated, LCP, black

Posts—Copper alloy, tin plated,
 .000030 [0.00076] or .000015
 [0.00038] gold over nickel

- Note:** 1. Post(s) can be omitted for keying purposes. Specify the desired post(s) to be omitted using the figure to identify Post No. 1.
 2. Gold headers are duplex plated, gold on mating end of post and tin on the solder tail.
 3. To determine header overall length (dim. A) multiply .100 x the number of posts. Example: .100 x 10 posts equals 1.000 inch [25.4 mm].

For mateability options, see matrix on pages 5 and 6.

For mating half visuals, see pages 7, 8 and 24.

Header Ordering Information

The “Base Part Numbers” Chart at right shows the base part number.

Prefixes and suffixes are determined by the number of post positions in the header. For example, the complete part number for a 10-position surface mount polarized header would be:

Base number **647106** plus
 prefix-and-suffix
4- -0

The correct ordering number is
4-647106-0

All part numbers are the RoHS equivalent version. Example:

No. of Pos.	Lead Free RoHS Prefix/Suffix
2	3-647106-2
12	4-647106-2

See page 8 for an explanation of RoHS lead free equivalents.

Note: All RoHS equivalent part numbers may not be available upon catalog release. If the number you need is not available, please contact Product Engineering to expedite your request.

For use with Infrared Reflow Process

Maximum Temperature Rating: 2-12 Position: 280°C
 13-18 Position: 235°C

Polarized Header

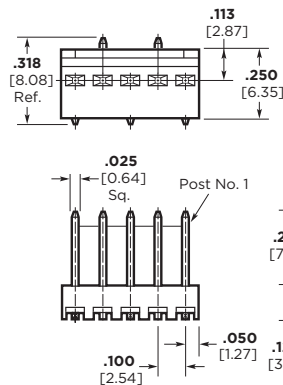

Friction Lock Header

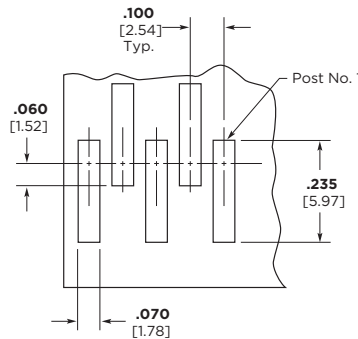
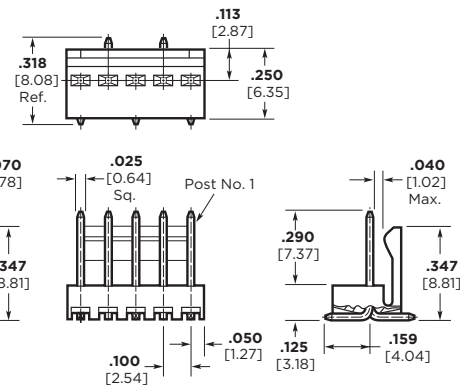

Note: Consult Product Drawing for details on placing headers onto PC boards.

Recommended PC Board Layout for use with .010 [0.25] Thick Stencil

Base Part Numbers

Polarized Headers		Friction Lock Headers	
Header Part Nos.	RoHS Equiv.	Header Part Nos.	RoHS Equiv.
Standard UL94V-0, Tin Plated			
647106	32-42	647166	32-42
Standard UL94V-0, .000030 [0.00076] Gold Plated			
647108	32-42	647168	32-42
Standard UL94V-0, .000015 [0.00038] Gold Plated			
647107	32-42	647167	32-42

Tape Mount Part Numbers

Polarized Headers		Friction Lock Headers	
Header Part Nos.	RoHS Equiv.	Header Part Nos.	RoHS Equiv.
Standard UL94V-0, Tin Plated			
647531	32-42	647502	32-42
Standard UL94V-0, .000030 [0.00076] Gold Plated			
		1744163	32-42
Standard UL94V-0, .000015 [0.00038] Gold Plated			
		647467	32-42

Note: Select load headers (omitted pin headers) are available upon request. Please contact product engineer or product manager for details.

MTA-100 Shrouded Headers—Straight and Right-Angle

Material and Finish

Housing—UL94V-0 rated, polyester, black

Posts—Copper alloy, tin plated, .000030 [0.00076] gold over nickel

Notes:

1. Post(s) can be omitted for keying purposes. Specify the desired post(s) to be omitted using the figure to identify Post No. 1.
2. Headers with .000015 [0.00038] gold plated post are available upon request. Minimums may apply.
3. Gold headers are duplex plated, gold on mating end of post and tin on the solder tail.

For mateability options, see matrix on pages 5 and 6.

For mating half visuals, see pages 7, 8 and 24.

Header Ordering Information

The “Base Part Numbers” Chart at right shows the base part number.

Prefixes and suffixes are determined by the number of post positions in the header. For example, the complete part number for a 10-position header with straight posts and with pegs would be:

Base number **644486** plus prefix-and-suffix **4--0**

The correct ordering number is **4-644486-0**

See page 15 for an explanation of RoHS lead free equivalents.

Note: All RoHS equivalent part numbers may not be available upon catalog release. If the number you need is not available, please contact Product Engineering to expedite your request.

Notes:

1. Select load headers (omitted pin headers) are available upon request. Please contact product engineer or product manager for details.
2. MTA-100 shrouded headers do not mate with CST-100 II housings.

Straight Post (.025 [0.64] Square)

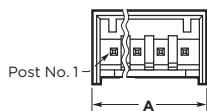

Right-Angle (.025 [0.64] Square)

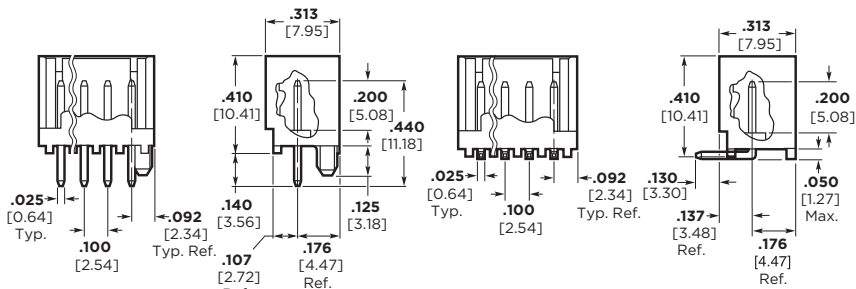
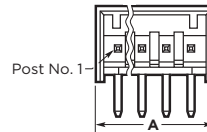

Front Bend

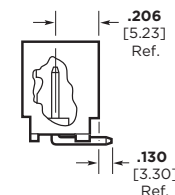

Rear Bend

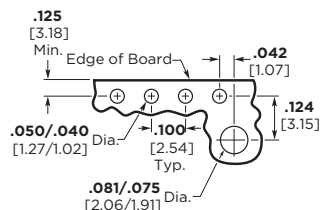

Recommended Mounting Hole Pattern for .062 [1.57] Thk. PC Board (Solder Side of Board Shown)

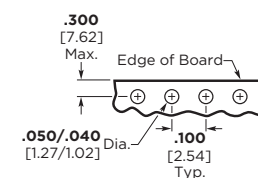

Recommended Mounting Hole Pattern for .062 [1.57] Thk. PC Board (Solder Side of Board Shown)

Note: Consult Product Drawing for details on placing headers onto PC boards.

Base Part Numbers

Straight Posts				Right-Angle Posts			
With Pegs		Without Pegs		Without Pegs Only			
Header Part Nos.	RoHS Equiv.	Header Part Nos.	RoHS Equiv.	Front Bend		Rear Bend	
Header Part Nos.	RoHS Equiv.	Header Part Nos.	RoHS Equiv.	Header Part Nos.	RoHS Equiv.	Header Part Nos.	RoHS Equiv.
Standard UL94V-0, Tin Plated							
644486	22-34	644861	22-34	644488	22-34	644803	22-34
Standard UL94V-0, .000030 [0.00076] Gold Plated							
644487	22-34	—	—	644489	22-34	—	—

Header Length

No. of Circuits	Dim. A	Prefix/Suffix	No. of Circuits	Dim. A	Prefix/Suffix	No. of Circuits	Dim. A	Prefix/Suffix	No. of Circuits	Dim. A	Prefix/Suffix
2	.284 7.21	3- -2	6	.684 17.37	3- -6	10	1.084 27.53	4- -0	14	1.484 37.69	4- -4
3	.384 9.75	3- -3	7	.784 19.91	3- -7	11	1.184 30.07	4- -1			
4	.484 12.29	3- -4	8	.884 22.45	3- -8	12	1.284 32.61	4- -2			
5	.584 14.83	3- -5	9	.984 24.99	3- -9	13	1.384 35.15	4- -3			

.100 [2.54] Centerline CST-100 II Crimp Contacts and Housings

PRODUCT FACTS

- Low cost wire-to-board interconnections
- Wide wire range for single contact
- Tin and gold plated contacts
- Mates with specified MTA and similar competitive notched headers
- Plastic latching feature in housing helps prevent contact backout
- Locking ramps and polarizing tabs are standard
- For keying purposes use keying plug 641994-1 (page 10)
- Recognized under the Component Program of Underwriters Laboratories Inc., File No. E28476
- Certified by Canadian Standards Association, File No. LR7189



For mateability options, see matrix on pages 5 and 6.

For mating half visuals, see pages 13 thru 23 and 25.

See page 8 for an explanation of RoHS lead free equivalents.

Performance Data

Voltage Rating—250 vac

Current Rating—4 amp max.

Low-Level Resistance—
6 mΩ max. initial; 10 mΩ max. initial

Dielectric Withstanding Voltage—
750 vac/1 min.

Insulation Resistance—1000 MΩ min.
initial; 100 MΩ min. final

Operating Temperature—
-55° C to +105° C

Technical Documents

Product Specification
108-1948

Application Specifications
114-13036

Instruction Sheet
408-8493

Application Tooling

Loose Piece Contacts—Hand Tool No.
58517-3 (408-4064)

Strip Contacts—AMP-O-LECTRIC Model
“G” Termination Machine* Applicator No.
567373-3 (Request Catalog 65828)

AMP-O-MATIC Stripper-Crimper Machine*
Applicator No. 567910-1 or 567827-1 (with
CQM) (Request Catalog 65004)

AMPOMATOR CLS IIIG Lead Making Ma-
chine* (Request Catalog 82659)

*Requires applicators. For part numbers, call Technical Support.



Contacts

Part Numbers		
Tin Plated	15 Au Gold Plated	30 Au Gold Plated
1375819-1 (Strip)	1375819-2 (Strip)	1375819-3 (Strip)
1445336-1 (Loose Piece)	1445336-2 (Loose Piece)	1445336-3 (Loose Piece)

Material and Finish (RoHS Compliant)

Phosphor bronze, pretinned or .000015 [0.00038] gold, over nickel
.000030 [0.00076] gold over nickel

Wire Range—22–26 AWG [0.35–0.13 mm²]

Max. Ins. Dia.— .065 [1.65]

Housing*

Material (RoHS Compliant)

UL94V-0 rated, nylon, white

No. of Pos.	Dim. A	Part Numbers
2	.220 5.59	1375820-2
3	.320 8.13	1375820-3
4	.420 10.67	1375820-4
5	.520 13.21	1375820-5
6	.620 15.75	1375820-6
7	.720 18.29	1375820-7
8	.820 20.83	1375820-8
9	.920 23.37	1375820-9
10	1.020 25.91	1-1375820-0
11	1.120 28.45	1-1375820-1
12	1.220 30.99	1-1375820-2
13	1.320 33.53	1-1375820-3
14	1.420 36.07	1-1375820-4
15	1.520 38.61	1-1375820-5

No. of Pos.	Dim. A	Part Numbers
16	1.620 41.15	1-1375820-6
17	1.720 43.69	1-1375820-7
18	1.820 46.23	1-1375820-8
19	1.920 48.77	1-1375820-9
20	2.020 51.31	2-1375820-0
21	2.120 53.85	2-1375820-1
22	2.220 56.39	2-1375820-2
23	2.320 58.93	2-1375820-3
24	2.420 61.47	2-1375820-4
25	2.520 64.01	2-1375820-5
26	2.620 66.55	2-1375820-6
27	2.720 69.09	2-1375820-7
28	2.820 71.63	2-1375820-8

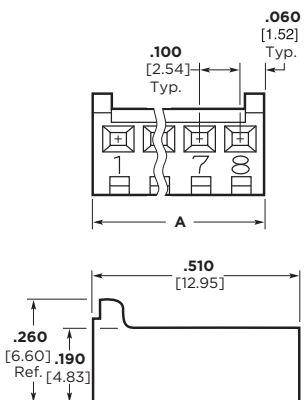
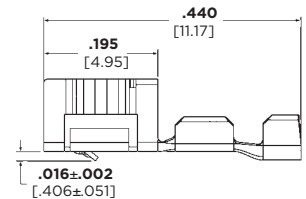

*Housings without polarizing tabs may be manufactured upon request. Minimums may apply. Contact product engineering or product manager for details.

CST-100 II Shrouded Headers—Straight and Right-Angle

Material and Finish

Housing—UL94V-0 rated, polyester, black

Posts—Copper alloy, tin plated, or .000030 [0.00076] gold over nickel

- Notes:** 1. Post(s) can be omitted for keying purposes. Specify the desired post(s) to be omitted using the figure to identify Post No. 1.
 2. Headers with .000015 [0.00038] gold plated post are available upon request. Minimums may apply.
 3. Gold headers are duplex plated, gold on mating end of post and tin on the solder tail.

For mateability options, see matrix on pages 5 and 6.

For mating half visuals, see page 23.

Header Ordering Information

The “Base Part Numbers” Chart at right shows the base part number and number of posts available for the described headers.

Prefixes and suffixes are determined by the number of post positions in the header. For example, the complete part number for a 10-position header with straight posts and with pegs would be:

Base number **644893** plus prefix-and-suffix
4- -0

The correct ordering number is
4-644893-0

All part numbers are the RoHS equivalent version. Example:

No. of Pos.	Lead Free RoHS Prefix/Suffix
2	3-644893-2
	thru
14	4-644893-4

See page 8 for an explanation of RoHS lead free equivalents.

Note: All RoHS equivalent part numbers may not be available upon catalog release. If the number you need is not available, please contact Product Engineering to expedite your request.

Note: CST-100 II shrouded headers only mate with CST-100 II housings. All the MTA-100 headers except the MTA-100 shrouded headers mate with CST-100 II housings.

Straight Post (.025 [0.64] Square)

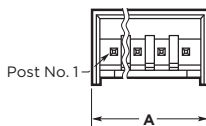

Right-Angle (.025 [0.64] Square)

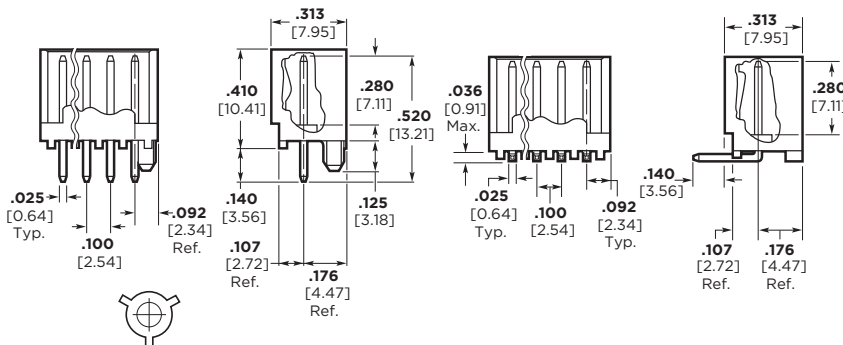
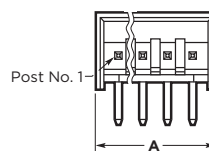

Polarized Retention Peg

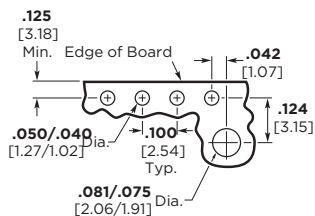

Note: Consult Product Drawing for details on placing headers onto PC boards.

Recommended Mounting Hole Pattern for .062 [1.57] Thk. PC Board (Solder Side of Board Shown)

Recommended Mounting Hole Pattern for .062 [1.57] Thk. PC Board (Solder Side of Board Shown)

Base Part Numbers

Straight Posts				Right-Angle Posts Without Pegs Only	
With Pegs		Without Pegs		Header Part Nos.	No. of Posts/RoHS Equiv.
Header Part Nos.	No. of Posts/RoHS Equiv.	Header Part Nos.	No. of Posts/RoHS Equiv.		
Standard UL94V-0, Tin Plated					
644893	32-44	644892	32-44	644894	32-44
Standard UL94V-0, .000030 [0.00076] Gold Plated					
644897	32-44	644896	32-44	644898	32-44

Header Length

No. of Circuits	Dim. A	Prefix/Suffix	No. of Circuits	Dim. A	Prefix/Suffix	No. of Circuits	Dim. A	Prefix/Suffix
2	.284 7.21	3- -2	5	.584 14.83	3- -5	8	.884 22.45	3- -8
3	.384 9.75	3- -3	6	.684 17.37	3- -6	9	.984 24.99	3- -9
4	.484 12.29	3- -4	7	.784 19.91	3- -7	10	1.084 27.53	4- -0

.156 [3.96] Centerline MTA-156 IDC Connectors and Headers

PRODUCT FACTS

- Connectors and headers for 2 through 24 positions; wire sizes of 18, 20, 22, 24 and 26 AWG [0.9–0.12 mm²]
- Connectors and headers, except shrouded headers, are end-to-end stackable
- Posted connectors for 2,3, 4, 6, 9, 12, 15 and 24 positions
- Card edge connectors for 3, 6, 9, 12, 15, 18 and 20 through 24 positions
- Connectors preloaded with IDC contacts
- All contacts are slotted for insulation displacement (IDC) termination technique
- Connector styles include both closed end and feedthru, with and without locking ramps and polarizing tabs
- Molded ribs on housing do not allow reverse mating
- Contacts are lubricated for fretting corrosion protection
- Benefits derived from the MTA-156 system include increases quality and ease of handling such as—
 - One-step assembly
 - No wire stripping
 - No contact damage
 - Reduced wiring errors
 - Simpler tooling
 - Simple maintenance and repair
- Meets the material requirements of Table 23.1 of UL1410 Standards for Television Receiver and Video Products (wire-to post connectors only)
- Recognized under the Component Program of Underwriters Laboratories Inc., File No. E28476
- Certified by Canadian Standards Association, File No. LR7189



MTA-156 connectors accept discrete and ribbon cable wire sizes ranging from 18–26 AWG [0.9–0.12 mm²] with maximum insulation outside diameter .095 [2.41] for single wire and .070 [1.78] for mass termination of wires. Tin plated solid, fused stranded or stranded (7, 16, and 19 strands) wire with PVC insulation can be used on 18 AWG [0.8–0.9 mm²] MTA-156 connectors; 7, 10, and 19 stranded wire on 20 AWG [0.5–0.6 mm²] MTA-156 connectors; and 7 and 19 stranded wire on 22–26 AWG [0.4–0.12 mm²] MTA-156 connectors.

Only one wire to be terminated into an IDC contact slot.

Mass termination of wire provides the lowest applied cost because it drastically reduces the labor content of virtually any cable or harness assembly required.

The wire-to-post connector housing material is flame retardant thermoplastic, either UL94V-2 or UL94V-0 rated.

A full line of .156 [3.96] centerline headers completes the system. Headers are available with straight or right-angle posts, in flat friction lock and shrouded styles. Headers are available in 2 through 24 positions.

Note: Refer to page 52 for approved wire listings.

Performance Data*

Voltage Rating—600 vac

Current Rating—7 amp max. for MTA-156 Connector

Low-Level Resistance—3.0 mΩ max. initial

Dielectric Withstanding Voltage—2200 vac/1 min.

Insulation Resistance—5000 MΩ min. initial

Operating Temperature—-55° C to +105° C

*Refer to the Product Specification for additional electrical, mechanical and environmental performance tests and requirements.

Technical Documents Product Specification

108-1051 MTA-156 Connectors

Application Specifications

114-1020 MTA-156 Connectors, Posted Connectors and Card Edge Connectors

114-1032 MTA-156 Ribbon Cable Assembly

MTA-156 Connector/Header Mateability Guide

This matrix has been prepared to assist you, our customer, in defining the correct mating halves for the MTA-156 header and connector combination. Where a “Y” is indicated the combination is a valid mating pair. Where an “N” is indicated the combination is not acceptable for mating.

Matrix for Tin Plated Part Numbers

		Headers																						
		640383	640384	640385	640387	640388	640389	640445	644611	644613	644615	644617	644749	644750	644751	644752	644753	644754	644755	647123	647125	647127	647646	744017
Connectors	640426	Y	Y	Y	Y	N	Y	Y	Y	Y	Y	Y	Y	Y	Y	Y	Y	Y	Y	Y	Y	Y	Y	Y
	640427	Y	Y	Y	N	Y	Y	Y	Y	Y	Y	Y	Y	Y	Y	Y	Y	Y	Y	Y	Y	Y	Y	Y
	640428	Y	Y	Y	N	Y	Y	Y	Y	Y	Y	Y	Y	Y	Y	Y	Y	Y	Y	Y	Y	Y	Y	Y
	640429	Y	Y	Y	N	Y	Y	Y	Y	Y	Y	Y	Y	Y	Y	Y	Y	Y	Y	Y	Y	Y	Y	Y
	640430	Y	Y	Y	N	Y	Y	Y	Y	Y	Y	Y	Y	Y	Y	Y	Y	Y	Y	Y	Y	Y	Y	Y
	640431	Y	Y	Y	Y	Y	Y	Y	Y	Y	Y	Y	Y	Y	Y	Y	Y	Y	Y	Y	Y	Y	Y	Y
	640432	Y	Y	Y	Y	Y	Y	Y	Y	Y	Y	Y	Y	Y	Y	Y	Y	Y	Y	Y	Y	Y	Y	Y
	640433	Y	Y	Y	Y	Y	Y	Y	Y	Y	Y	Y	Y	Y	Y	Y	Y	Y	Y	Y	Y	Y	Y	Y
	640434	Y	Y	Y	Y	Y	Y	Y	Y	Y	Y	Y	Y	Y	Y	Y	Y	Y	Y	Y	Y	Y	Y	Y
	640435	Y	Y	Y	Y	Y	Y	Y	Y	Y	Y	Y	Y	Y	Y	Y	Y	Y	Y	Y	Y	Y	Y	Y
	640472	Y	Y	Y	N	Y	Y	Y	Y	Y	Y	Y	Y	Y	Y	Y	Y	Y	N	Y	Y	Y	Y	Y
	640473	Y	Y	Y	N	Y	Y	Y	Y	Y	Y	Y	Y	Y	Y	Y	Y	Y	N	Y	Y	Y	Y	Y
	640474	Y	Y	Y	N	Y	Y	Y	Y	Y	Y	Y	Y	Y	Y	Y	Y	Y	N	Y	Y	Y	Y	Y
	640477	Y	Y	Y	Y	Y	Y	Y	Y	Y	Y	Y	Y	Y	Y	Y	Y	Y	Y	Y	Y	Y	Y	Y
	640480	Y	Y	Y	Y	Y	Y	Y	Y	Y	Y	Y	Y	Y	Y	Y	Y	Y	Y	Y	Y	Y	Y	Y
	640595	Y	Y	Y	N	Y	Y	Y	Y	Y	Y	Y	Y	Y	Y	Y	Y	Y	N	Y	Y	Y	Y	Y
	640599	Y	Y	Y	N	Y	Y	Y	Y	Y	Y	Y	Y	Y	Y	Y	Y	Y	N	Y	Y	Y	Y	Y
	640600	Y	Y	Y	N	Y	Y	Y	Y	Y	Y	Y	Y	Y	Y	Y	Y	Y	N	Y	Y	Y	Y	Y
	640601	Y	Y	Y	N	Y	Y	Y	Y	Y	Y	Y	Y	Y	Y	Y	Y	Y	N	Y	Y	Y	Y	Y
	640602	Y	Y	Y	N	Y	Y	Y	Y	Y	Y	Y	Y	Y	Y	Y	Y	Y	N	Y	Y	Y	Y	Y
	640604	Y	Y	Y	Y	Y	Y	Y	Y	Y	Y	Y	Y	Y	Y	Y	Y	Y	Y	Y	Y	Y	Y	Y
	640605	Y	Y	Y	Y	Y	Y	Y	Y	Y	Y	Y	Y	Y	Y	Y	Y	Y	Y	Y	Y	Y	Y	Y
	640606	Y	Y	Y	Y	Y	Y	Y	Y	Y	Y	Y	Y	Y	Y	Y	Y	Y	Y	Y	Y	Y	Y	Y
	640607	Y	Y	Y	Y	Y	Y	Y	Y	Y	Y	Y	Y	Y	Y	Y	Y	Y	Y	Y	Y	Y	Y	Y
	640608	Y	Y	Y	Y	Y	Y	Y	Y	Y	Y	Y	Y	Y	Y	Y	Y	Y	Y	Y	Y	Y	Y	Y
	641302	Y	Y	Y	N	Y	Y	Y	Y	Y	Y	Y	Y	Y	Y	Y	Y	Y	N	Y	Y	Y	Y	Y
	643817	Y	Y	Y	N	Y	Y	Y	Y	Y	Y	Y	Y	Y	Y	Y	Y	Y	N	Y	Y	Y	Y	Y
	643818	Y	Y	Y	N	Y	Y	Y	Y	Y	Y	Y	Y	Y	Y	Y	Y	Y	N	Y	Y	Y	Y	Y
	643819	Y	Y	Y	N	Y	Y	Y	Y	Y	Y	Y	Y	Y	Y	Y	Y	Y	N	Y	Y	Y	Y	Y
	643820	Y	Y	Y	N	Y	Y	Y	Y	Y	Y	Y	Y	Y	Y	Y	Y	Y	N	Y	Y	Y	Y	Y
	643821	Y	Y	Y	N	Y	Y	Y	Y	Y	Y	Y	Y	Y	Y	Y	Y	Y	N	Y	Y	Y	Y	Y
	644082	Y	Y	Y	Y	Y	Y	Y	Y	Y	Y	Y	Y	Y	Y	Y	Y	Y	Y	Y	Y	Y	Y	Y
	644461	Y	Y	Y	Y	Y	Y	Y	Y	Y	Y	Y	Y	Y	Y	Y	Y	Y	Y	Y	Y	Y	Y	Y
	644462	Y	Y	Y	Y	Y	Y	Y	Y	Y	Y	Y	Y	Y	Y	Y	Y	Y	Y	Y	Y	Y	Y	Y
	644463	Y	Y	Y	Y	Y	Y	Y	Y	Y	Y	Y	Y	Y	Y	Y	Y	Y	Y	Y	Y	Y	Y	Y
	644464	Y	Y	Y	Y	Y	Y	Y	Y	Y	Y	Y	Y	Y	Y	Y	Y	Y	Y	Y	Y	Y	Y	Y
	644465	Y	Y	Y	N	Y	Y	Y	Y	Y	Y	Y	Y	Y	Y	Y	Y	Y	N	Y	Y	Y	Y	Y
	644466	Y	Y	Y	N	Y	Y	Y	Y	Y	Y	Y	Y	Y	Y	Y	Y	Y	N	Y	Y	Y	Y	Y
	644467	Y	Y	Y	N	Y	Y	Y	Y	Y	Y	Y	Y	Y	Y	Y	Y	Y	N	Y	Y	Y	Y	Y
	644468	Y	Y	Y	N	Y	Y	Y	Y	Y	Y	Y	Y	Y	Y	Y	Y	Y	N	Y	Y	Y	Y	Y
	644469	Y	Y	Y	Y	Y	Y	Y	Y	Y	Y	Y	Y	Y	Y	Y	Y	Y	Y	Y	Y	Y	Y	Y
	644470	Y	Y	Y	Y	Y	Y	Y	Y	Y	Y	Y	Y	Y	Y	Y	Y	Y	Y	Y	Y	Y	Y	Y
	644471	Y	Y	Y	Y	Y	Y	Y	Y	Y	Y	Y	Y	Y	Y	Y	Y	Y	Y	Y	Y	Y	Y	Y
	644501	Y	Y	Y	Y	Y	Y	Y	Y	Y	Y	Y	Y	Y	Y	Y	Y	Y	Y	Y	Y	Y	Y	Y
	644502	Y	Y	Y	Y	Y	Y	Y	Y	Y	Y	Y	Y	Y	Y	Y	Y	Y	Y	Y	Y	Y	Y	Y
644566	Y	Y	Y	Y	Y	Y	Y	Y	Y	Y	Y	Y	Y	Y	Y	Y	Y	Y	Y	Y	Y	Y	Y	
644570	Y	Y	Y	Y	Y	Y	Y	Y	Y	Y	Y	Y	Y	Y	Y	Y	Y	Y	Y	Y	Y	Y	Y	
644783	Y	Y	Y	N	Y	Y	Y	Y	Y	Y	Y	Y	Y	Y	Y	Y	Y	N	Y	Y	Y	Y	Y	
644791	Y	Y	Y	Y	Y	Y	Y	Y	Y	Y	Y	Y	Y	Y	Y	Y	Y	Y	Y	Y	Y	Y	Y	
644860	Y	Y	Y	N	Y	Y	Y	Y	Y	Y	Y	Y	Y	Y	Y	Y	Y	N	Y	Y	Y	Y	Y	
644878	Y	Y	Y	N	Y	Y	Y	Y	Y	Y	Y	Y	Y	Y	Y	Y	Y	N	Y	Y	Y	Y	Y	

MTA, CST-100 II and SL-156 Connectors

MTA-156 Connector/Header Mateability Guide (continued)

This matrix has been prepared to assist you, our customer, in defining the correct mating halves for the MTA-156 header and connector combination. Where a “Y” is indicated the combination is a valid mating pair. Where an “N” is indicated the combination is not acceptable for mating.

Matrix for
.00030
[0.00076]
Gold Plated
Part Numbers

Connectors	Headers												
	641202	641203	641204	641207	641208	641209	641210	644631	644633	644756	644759	644760	644761
641217	Y	Y	Y	N	Y	Y	Y	Y	Y	Y	Y	Y	Y
641218	Y	Y	Y	N	Y	Y	Y	Y	Y	Y	Y	Y	Y
641219	Y	Y	Y	N	Y	Y	Y	Y	Y	Y	Y	Y	Y
641220	Y	Y	Y	N	Y	Y	Y	Y	Y	Y	Y	Y	Y
641222	Y	Y	Y	Y	Y	Y	Y	Y	Y	Y	Y	Y	Y
641223	Y	Y	Y	Y	Y	Y	Y	Y	Y	Y	Y	Y	Y
641224	Y	Y	Y	Y	Y	Y	Y	Y	Y	Y	Y	Y	Y
641226	Y	Y	Y	Y	Y	Y	Y	Y	Y	Y	Y	Y	Y
641227	Y	Y	Y	N	Y	Y	Y	Y	Y	Y	Y	Y	Y
641228	Y	Y	Y	N	Y	Y	Y	Y	Y	Y	Y	Y	Y
641229	Y	Y	Y	N	Y	Y	Y	Y	Y	Y	Y	Y	Y
641230	Y	Y	Y	N	Y	Y	Y	Y	Y	Y	Y	Y	Y
641235	Y	Y	Y	Y	Y	Y	Y	Y	Y	Y	Y	Y	Y
644460	Y	Y	Y	N	Y	Y	Y	Y	Y	Y	Y	Y	Y
644662	Y	Y	Y	N	Y	Y	Y	Y	Y	Y	Y	Y	Y
644663	Y	Y	Y	N	Y	Y	Y	Y	Y	Y	Y	Y	Y
644718	Y	Y	Y	N	Y	Y	Y	Y	Y	Y	Y	Y	Y
644720	Y	Y	Y	N	Y	Y	Y	Y	Y	Y	Y	Y	Y

Matrix for
.000015
[0.00038]
Gold Plated
Part Numbers

Connectors	Headers							
	641113	641119	641120	641121	644766	644767	644768	644769
641148	Y	Y	Y	Y	Y	Y	Y	N
641149	Y	Y	Y	Y	Y	Y	Y	N
641150	Y	Y	Y	Y	Y	Y	Y	N
641151	Y	Y	Y	Y	Y	Y	Y	N
641168	Y	Y	Y	Y	Y	Y	Y	N
641170	Y	Y	Y	Y	Y	Y	Y	N
641175	Y	Y	Y	Y	Y	Y	Y	Y
644284	Y	Y	Y	Y	Y	Y	Y	N
647478	Y	Y	Y	Y	Y	Y	Y	N
647479	Y	Y	Y	Y	Y	Y	Y	N

MTA-156 IDC Connectors—Closed End

Material and Finish

Housing—UL94V-2 rated, nylon, see below for color; or UL94V-0 rated, nylon, black

Contacts—Phosphor bronze, post tin plated, .000030 [0.00076] or .000015 [0.00038] post gold plated over nickel

Color Coding by Wire Size for UL94V-2 Connectors

26 AWG—Blue

24 AWG—White

22 AWG—Red

20 AWG—Yellow

18 AWG—Orange

All wire sizes in UL94V-0—Black

Notes:

1. Only connectors with locking ramp and without polarizing tabs mate with posted connectors on page 38.
2. Refer to pages 52-56 for approved wire listing.
3. For strain reliefs and dust covers, see page 9.
4. For keying plugs and panel mount end caps, see page 35.
5. Other circuit sizes are available upon request. Minimums may apply.
6. Connector circuits can be molded closed for keying purposes. Minimums may apply.
7. Where no part numbers appear in the chart, parts can be made available upon request. Minimums may apply.
8. To determine connector overall length (dim. A), multiply .156 x the number of circuits. Example: .156 x 10 circuits equals 1.560 inch [39.62 mm].

Closed End with Locking Ramp

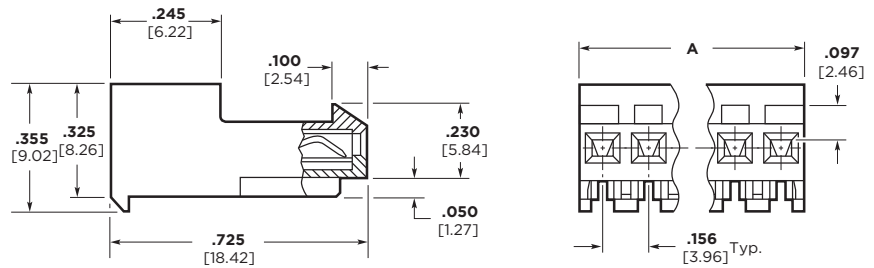

without Polarizing Tabs



with Polarizing Tabs

For mateability options, see matrix on pages 27 and 28.

Mating half visuals for Closed End Connectors with Locking Ramp, see pages 38 thru 41, 43, 45, and 46, (42 and 44 Front Bend Headers only).

Closed End without Locking Ramp

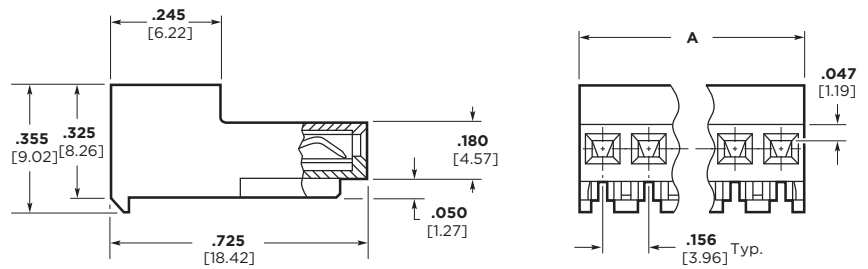

without Polarizing Tabs

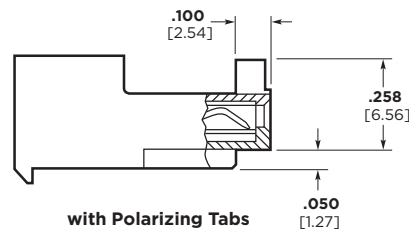

with Polarizing Tabs

For mateability options, see matrix on pages 27 and 28.

Mating half visuals for Closed End Connectors without Locking Ramp, see pages 39 thru 46.

MTA-156 IDC Connectors—Closed End (continued)

Connector Ordering Information

The “Base Part Numbers” Chart at right shows the base part number and number of circuits available for the described connectors.

Prefixes and suffixes are determined by the number of circuit positions in the connector. For example, the complete part number for a 10-position closed end connector with locking ramp and without polarizing tabs for 18 AWG wire would be:

Base number **640426** plus
prefix-and-suffix
4- -0

The correct ordering number is
4-640426-0

All part numbers **bold face** are the RoHS equivalent version. Example:

No. of Pos.	Lead Free RoHS Prefix/Suffix
2	3-640426-2
3	3-640426-3
4	3-640426-4
5	3-640426-5
6	3-640426-6
7	3-640426-7
8	3-640426-8
9	3-640426-9
10	4-640426-0
11	4-640426-1
12	4-640426-2
13	4-640426-3
14	4-640426-4
15	4-640426-5
16	4-640426-6
17	4-640426-7
18	4-640426-8
19	4-640426-9
20	5-640426-0
21	5-640426-1
22	5-640426-2
23	5-640426-3
24	5-640426-4

Note: All RoHS equivalent part numbers may not be available upon catalog release. If the number you need is not available, please contact Product Engineering to expedite your request.

Base Part Numbers

Connector Type & Wire Size	Closed End with Locking Ramp				Closed End without Locking Ramp			
	Without Tabs		With Tabs		Without Tabs		With Tabs	
	Connector Part Nos.	RoHS Equiv.	Connector Part Nos.	RoHS Equiv.	Connector Part Nos.	RoHS Equiv.	Connector Part Nos.	RoHS Equiv.
Standard UL94V-2, Tin Plated								
18 AWG 0.8-0.9 mm ²	640426	32-54	643817	32-54	640431	32-54	644461 ¹	32-44
20 AWG 0.5-0.6 mm ²	640427	32-54	643818	32-54	640432	32-54	644462 ¹	32-44
22 AWG 0.3-0.4 mm ²	640428	32-54	643819	32-54	640433	32-54	644463 ¹	32-44
24 AWG 0.2 mm ²	640429	32-54	643820	32-54	640434	32-54	644464 ¹	32-44
26 AWG 0.12-0.15 mm ²	640430	32-54	643821	32-54	640435	32-54	—	—
Tape Mounted on Reel UL94V-2, Tin Plated								
18 AWG 0.8-0.9 mm ²	640472	32-54	644878	32-54	640477	32-54	—	—
20 AWG 0.5-0.6 mm ²	640473	32-54	—	—	—	—	—	—
22 AWG 0.3-0.4 mm ²	640474	32-54	644783	32-54	—	—	644791 ¹	32-44
24 AWG 0.2 mm ²	—	—	—	—	640480	32-54	—	—
26 AWG 0.12-0.15 mm ²	—	—	—	—	—	—	—	—
Standard UL94V-2, .000030 [0.00076] Gold Plated								
18 AWG 0.8-0.9 mm ²	641217	32-54	644460 ¹	32-42	641222	32-54	—	—
20 AWG 0.5-0.6 mm ²	641218	32-54	644663 ¹	32-42	641223	32-54	—	—
22 AWG 0.3-0.4 mm ²	641219	32-54	644662 ¹	32-42	641224	32-54	644687 ¹	32-44
24 AWG 0.2 mm ²	641220	32-54	—	—	641225	32-54	—	—
26 AWG 0.12-0.15 mm ²	641221	32-54	—	—	641226	32-54	—	—
Standard UL94V-2, .000015 [0.00038] Gold Plated								
18 AWG 0.8-0.9 mm ²	641148	32-54	644284 ¹	32-42	641153	32-54	—	—
20 AWG 0.5-0.6 mm ²	641149	32-54	—	—	641154	32-54	—	—
22 AWG 0.3-0.4 mm ²	641150	32-54	647478 ¹	32-42	641155	32-54	—	—
24 AWG 0.2 mm ²	641151	32-54	—	—	641156	32-54	—	—
26 AWG 0.12-0.15 mm ²	641152	32-54	—	—	641157	32-54	—	—
Standard UL94V-0, Tin Plated (Black in color)								
18 AWG 0.8-0.9 mm ²	644860	32-42	—	—	644502	32-42	644082 ¹	32-42
22 AWG 0.3-0.4 mm ²	—	—	—	—	644501	32-42	644566 ¹	32-42

¹ Other circuit sizes are available upon request. Minimums may apply.

Note: Blocked circuit configurations are available upon request. Contact product engineer or product manager for details. Minimums may apply.

MTA-156 IDC Connectors—Feed-Thru

Material and Finish

Housing—UL94V-2 rated, nylon, see below for color; or UL94V-0 rated, nylon, black

Contacts—Phosphor bronze, post tin plated, .000030 [0.00076] or .000015 [0.00038] post gold-plated over nickel

Color Coding by Wire Size for UL94V-2 Connectors

26 AWG—Blue

24 AWG—White

22 AWG—Red

20 AWG—Yellow

18 AWG—Orange

All wire sizes in UL94V-0—Black

Notes:

1. Only connectors with locking ramp and without polarizing tabs mate with posted connectors on page 38.
2. Refer to pages 52-56 for approved wire listing.
3. For strain reliefs and dust covers, see page 33 and 34.
4. For keying plugs and panel mount end caps, see page 35.
5. Other circuit sizes are available upon request. Minimums may apply.
6. Connector circuits can be molded closed for keying purposes. Minimums may apply.
7. Where no part numbers appear in the chart, parts can be made available upon request. Minimums may apply.
8. To determine connector overall length (dim. A), multiply .156 x the number of circuits. Example: .156 x 10 circuits equals 1.560 inch [39.62 mm].

Feed-Thru with Locking Ramp



without Polarizing Tabs



with Polarizing Tabs

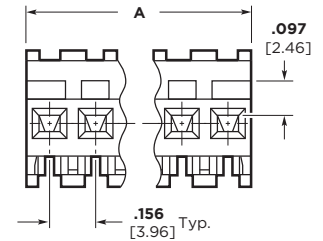

For mateability options, see matrix on pages 27 and 28.

Mating half visuals for Closed End Connectors with Locking Ramp, see pages 38 thru 41, 43, 45, and 46, (42 and 44 Front Bend Headers only).

Feed-Thru without Locking Ramp



without Polarizing Tabs



with Polarizing Tabs

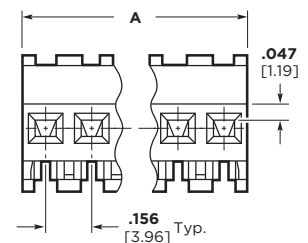

For mateability options, see matrix on pages 27 and 28.

Mating half visuals for Closed End Connectors without Locking Ramp, see pages 39 thru 46.

MTA-156 IDC Connectors—Feed-Thru (continued)

Connector Ordering Information

The “Base Part Numbers” Chart at right shows the base part number and number of circuits available for the described connectors.

Prefixes and suffixes are determined by the number of circuit positions in the connector. For example, the complete part number for a 10-position feed-thru connector with locking ramp and without polarizing tabs for 18 AWG wire would be:

Base number **640599** plus
prefix-and-suffix
4- - 0

The correct ordering number is
4-640599-0

All part numbers **bold face** are the RoHS equivalent version. Example:

No. of Pos.	Lead Free RoHS Prefix/Suffix
2	3-640599-2
3	3-640599-3
4	3-640599-4
5	3-640599-5
6	3-640599-6
7	3-640599-7
8	3-640599 -8
9	3-640599-9
10	4-640599-0
11	4-640599-1
12	4-640599-2
13	4-640599-3
14	4-640599-4
15	4-640599-5
16	4-640599-6
17	4-640599-7
18	4-640599-8
19	4-640599-9
20	5-640599-0
21	5-640599-1
22	5-640599-2
23	5-640599-3
24	5-640599-4

Note: All RoHS equivalent part numbers may not be available upon catalog release. If the number you need is not available, please contact Product Engineering to expedite your request.

Base Part Numbers

Connector Type & Wire Size	Feed-Thru with Locking Ramp				Feed-Thru without Locking Ramp			
	Without Tabs		With Tabs		Without Tabs		With Tabs	
	Connector Part Nos.	RoHS Equiv.	Connector Part Nos.	RoHS Equiv.	Connector Part Nos.	RoHS Equiv.	Connector Part Nos.	RoHS Equiv.
Standard UL94V-2, Tin Plated								
18 AWG 0.8-0.9 mm ²	640599	32-54	644465 ¹	32-44	640604	32-54	644469 ¹	32-44
20 AWG 0.5-0.6 mm ²	640600	32-54	644466 ¹	32-44	640605	32-54	644470 ¹	32-44
22 AWG 0.3-0.4 mm ²	640601	32-54	644467 ¹	32-44	640606	32-54	644471 ¹	32-44
24 AWG 0.2 mm ²	640602	32-54	644468 ¹	32-44	640607	32-54	—	—
26 AWG 0.12-0.15 mm ²	640595	32-54	—	—	640608	32-54	—	—
Tape Mounted on Reel UL94V-2, Tin Plated								
18 AWG 0.8-0.9 mm ²	641302	32-54	—	—	—	—	—	—
20 AWG 0.5-0.6 mm ²	—	—	—	—	—	—	—	—
22 AWG 0.3-0.4 mm ²	—	—	—	—	—	—	—	—
24 AWG 0.2 mm ²	—	—	—	—	—	—	—	—
26 AWG 0.12-0.15 mm ²	—	—	—	—	—	—	—	—
Standard UL94V-2, .00003 [.00076] Gold Plated								
18 AWG 0.8-0.9 mm ²	—	—	644718 ¹	32-44	641232	32-54	—	—
20 AWG 0.5-0.6 mm ²	—	—	—	—	641233	32-54	—	—
22 AWG 0.3-0.4 mm ²	—	—	644720 ¹	32-44	641234	32-54	—	—
24 AWG 0.2 mm ²	—	—	—	—	641235	32-54	—	—
26 AWG 0.12-0.15 mm ²	641231	32-54	—	—	641236	32-54	—	—
Standard UL94V-2, .000015 [.00038] Gold Plated								
18 AWG 0.8-0.9 mm ²	641168	32-54	647479 ¹	32-42	—	—	—	—
20 AWG 0.5-0.6 mm ²	—	—	—	—	—	—	—	—
22 AWG 0.3-0.4 mm ²	641170	32-54	647496 ¹	32-42	641175	32-54	—	—
24 AWG 0.2 mm ²	—	—	—	—	—	—	—	—
26 AWG 0.12-0.15 mm ²	—	—	—	—	—	—	—	—
Standard UL94V-0, Tin Plated								
18 AWG 0.8-0.9 mm ²	—	—	—	—	—	—	644570 ¹	32-42
22 AWG 0.3-0.4 mm ²	—	—	—	—	—	—	—	—

¹ Other circuit sizes are available upon request. Minimums may apply.

Note: Blocked circuit configurations are available upon request. Contact product engineer or product manager for details. Minimums may apply.

MTA-156 Connector Accessories

Covers

Material (RoHS Compliant)

Strain Relief Covers—UL94V-2 rated, nylon, white

Dust Covers—UL94V-0 rated, polyester, white

Strain Relief Covers



Dust Covers



Base Part Numbers

Closed End			
Strain Relief Covers		Dust Covers	
Cover Part Nos.	No. of Circuits	Cover Part Nos.	No. of Circuits
643067	2-24	640551	2-24

Feed-Thru Covers

Material (RoHS Compliant)

Strain Relief Cover—UL94V-2 rated, nylon, white

Dust Covers—UL94V-0 rated, polyester, white

Strain Relief Covers



Dust Covers



Base Part Numbers

Feed-Thru			
Strain Relief Covers		Dust Covers	
Cover Part Nos.	No. of Circuits	Cover Part Nos.	No. of Circuits
643071	2-24	640643	2-24

Cover Ordering Information

The “Base Part Numbers” Chart at right shows the base part number and number of circuits available for the described cover.

Prefixes and suffixes are determined by the number of circuit positions in the cover. For example, the complete part number for a 10-position closed-end strain relief cover would be:

Base number **643067** plus
prefix-and-suffix
1- -0

The correct ordering number is
1-643067-0

Cover Length

No. of Circuits	Dim. A	Prefix/Suffix	No. of Circuits	Dim. A	Prefix/Suffix	No. of Circuits	Dim. A	Prefix/Suffix
2	.312 7.92	-2	10	1.560 39.62	1- -0	18	2.808 71.32	1- -8
3	.468 11.89	-3	11	1.716 43.59	1- -1	19	2.964 75.29	1- -9
4	.624 15.85	-4	12	1.872 47.55	1- -2	20	3.120 79.25	2- -0
5	.780 19.81	-5	13	2.028 51.51	1- -3	21	3.276 83.21	2- -1
6	.936 23.77	-6	14	2.184 55.47	1- -4	22	3.432 87.17	2- -2
7	1.092 27.74	-7	15	2.340 59.44	1- -5	23	3.588 91.14	2- -3
8	1.248 31.7	-8	16	2.496 63.4	1- -6	24	3.744 95.1	2- -4
9	1.404 35.66	-9	17	2.652 67.36	1- -7			

MTA-156 Connector Accessories (continued)

Replacement IDC Contacts

Material and Finish

Contacts—Phosphor bronze, post tin plated, .000030 [0.00076] or .000015 [0.00038] post gold plated over nickel

Notes: TE does not recommend terminating an MTA contact more than one time. Use replacement contacts when required for field repairs or wire changes.

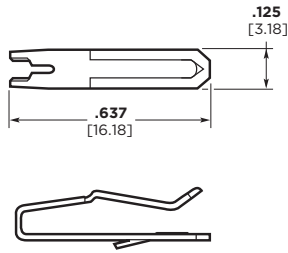

Wire Size		Part Numbers		
AWG	mm ²		.000030 [0.00076]	.000015 [0.00038]
		Tin Plated	Gold Plated	Gold Plated
18	0.8-0.9	640631-3	641143-4	641143-3
20	0.5-0.6	640632-3	641144-4	641144-3
22	0.3-0.4	640633-3	641145-4	641145-3
24	0.2	640634-3	641146-4	641146-3
26	0.12-0.15	640635-3	641147-4	641147-3

Crimp Snap-in Contacts

Material and Finish

Contacts—Phosphor bronze, tin plated



Wire Size		Part Nos.	
AWG	mm ²	Loose Piece*	Strip**
26-22	.12-0.3	640557-3	640556-3
22-18	0.3-0.9	640559-3	640558-3

*Hand Tool No. 59837-1 (408-6528)

**AMP-O-ELECTRIC Model "G" Termination Machine (Request Catalog 65828)

Note: Requires applicator. For part number, call Technical Support.

Special applications for crimp snap-in contacts are:

1. Double wire per contact
2. Coax or shielded wire
3. Mixed wire size in same connector

Note: Only one crimp snap-in contact per connector.

MTA-156 Connector Accessories (continued)

Keying Plugs

Material (RoHS Compliant)

UL94V-2 rated, nylon, natural color

Note: Removal of contact is not necessary when using keying plug.

Loose Piece

Part No. 640629-1 (Flush) Used with keyed headers



Part No. 640630-1 (Long Nose) Used with staked post



On Carrier Strip

Part No. 641623-1 (Flush) (10 per strip)



Panel Mount End Caps

Part No. 641440-1

Part No. 641533-1

(2-position only)

Material (RoHS Compliant)

UL94V-2 rated, nylon, black

Notes:

- Both left-hand and right-hand end caps are attached by a connecting tab. This tab must be broken off prior to installing on connector.
- For best results attach panel mount end caps to the MTA-156 (IDC) connectors shown on pages 29 thru 32. While not preferred, panel mount end caps can be attached to MTA-156 (IDC) posted connector on page 38.



3- thru 24-Position
641440-1
See Note 1



Two-Position Only
641533-1

No. of Pos.	Dim. A
3	.736 18.69
4	.892 22.66
6	1.204 30.58
9	1.672 42.47
12	2.140 54.36
15	2.608 66.24
24	4.012 101.9

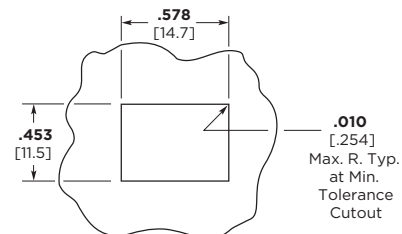

Recommended Panel Cutout
(Recommended Panel Thickness .062 [1.57] to .067 [1.70] max.)

MTA-156 Posted Connector/Connector Mateability Guide

This matrix has been prepared to assist you, our customer, in defining the correct mating halves for the MTA-156 posted connector and connector combination. Where a “Y” is indicated the combination is a valid mating pair. Where an “N” is indicated the combination is not acceptable for mating.

Matrix for Tin Plated Part Numbers

		Posted Connectors								
		641435	641436	641437	641438	641439	641522	641523	641524	641525
Connectors	640426	Y	Y	Y	Y	Y	Y	Y	Y	Y
	640427	Y	Y	Y	Y	Y	Y	Y	Y	Y
	640428	Y	Y	Y	Y	Y	Y	Y	Y	Y
	640429	Y	Y	Y	Y	Y	Y	Y	Y	Y
	640430	Y	Y	Y	Y	Y	Y	Y	Y	Y
	640431	N	N	N	N	N	N	N	N	N
	640432	N	N	N	N	N	N	N	N	N
	640433	N	N	N	N	N	N	N	N	N
	640434	N	N	N	N	N	N	N	N	N
	640435	N	N	N	N	N	N	N	N	N
	640472	Y	Y	Y	Y	Y	Y	Y	Y	Y
	640473	Y	Y	Y	Y	Y	Y	Y	Y	Y
	640474	Y	Y	Y	Y	Y	Y	Y	Y	Y
	640477	N	N	N	N	N	N	N	N	N
	640480	N	N	N	N	N	N	N	N	N
	640595	Y	Y	Y	Y	Y	Y	Y	Y	Y
	640599	Y	Y	Y	Y	Y	Y	Y	Y	Y
	640600	Y	Y	Y	Y	Y	Y	Y	Y	Y
	640601	Y	Y	Y	Y	Y	Y	Y	Y	Y
	640602	Y	Y	Y	Y	Y	Y	Y	Y	Y
	640604	N	N	N	N	N	N	N	N	N
	640605	N	N	N	N	N	N	N	N	N
	640606	N	N	N	N	N	N	N	N	N
	640607	N	N	N	N	N	N	N	N	N
	640608	N	N	N	N	N	N	N	N	N
	641302	Y	Y	Y	Y	Y	Y	Y	Y	Y
	643817	N	N	N	N	N	N	N	N	N
	643818	N	N	N	N	N	N	N	N	N
	643819	N	N	N	N	N	N	N	N	N
	643820	N	N	N	N	N	N	N	N	N
	643821	N	N	N	N	N	N	N	N	N
	644082	N	N	N	N	N	N	N	N	N
	644461	N	N	N	N	N	N	N	N	N
	644462	N	N	N	N	N	N	N	N	N
	644463	N	N	N	N	N	N	N	N	N
	644464	N	N	N	N	N	N	N	N	N
	644465	N	N	N	N	N	N	N	N	N
	644466	N	N	N	N	N	N	N	N	N
	644467	N	N	N	N	N	N	N	N	N
	644468	N	N	N	N	N	N	N	N	N
	644469	N	N	N	N	N	N	N	N	N
	644470	N	N	N	N	N	N	N	N	N
	644471	N	N	N	N	N	N	N	N	N
	644501	N	N	N	N	N	N	N	N	N
644502	N	N	N	N	N	N	N	N	N	
644566	N	N	N	N	N	N	N	N	N	
644570	N	N	N	N	N	N	N	N	N	
644783	N	N	N	N	N	N	N	N	N	
644791	N	N	N	N	N	N	N	N	N	
644860	Y	Y	Y	Y	Y	Y	Y	Y	Y	
644878	N	N	N	N	N	N	N	N	N	

MTA-156 Posted Connector/Connector Mateability Guide (continued)

This matrix has been prepared to assist you, our customer, in defining the correct mating halves for the MTA-156 posted connector and connector combination. Where a “Y” is indicated the combination is a valid mating pair. Where an “N” is indicated the combination is not acceptable for mating.

**Matrix for
.000030
[0.00076]
Gold Plated
Part Numbers**

		Posted Connectors			
		644807	644809	644812	644814
Connectors	641217	Y	Y	Y	Y
	641218	Y	Y	Y	Y
	641219	Y	Y	Y	Y
	641220	Y	Y	Y	Y
	641222	N	N	N	N
	641223	N	N	N	N
	641224	N	N	N	N
	641226	N	N	N	N
	641227	Y	Y	Y	Y
	641228	Y	Y	Y	Y
	641229	Y	Y	Y	Y
	641230	Y	Y	Y	Y
	641235	N	N	N	N
	644460	N	N	N	N
	644662	N	N	N	N
	644663	N	N	N	N
	644718	N	N	N	N
	644720	N	N	N	N

**Matrix for
.000015
[0.00038]
Gold Plated
Part Numbers**

		Posted Connectors		
		643995	647476	647481
Connectors	641148	Y	Y	Y
	641149	Y	Y	Y
	641150	Y	Y	Y
	641151	Y	Y	Y
	641168	Y	Y	Y
	641170	Y	Y	Y
	641175	N	N	N
	644284	N	N	N
	647478	N	N	N
	647479	N	N	N

MTA-156 IDC Posted Connectors (Wire-to-Wire)—Closed End, Feed-Thru

Material and Finish

Housing—UL94V-2 rated, nylon, see chart for color

Contacts—Copper alloy, post tin or .000030 [.00076] gold plated over nickel



- Note:** 1. Mating half visuals — pages 29 & 32.
2. Strain relief & dust covers — pages 33 & 34.
3. Approved wire listing — page 52.

Base Part Numbers

Connector Type & Wire Size	Closed End Connector		Feed-Thru Connector	
	Part Nos.	RoHS Equiv.	Part Nos.	RoHS Equiv.
Standard UL 94V-2, Tin Plated				
18 AWG 0.8-0.9 mm ²	641435	32,33,34,36,39,42,45,54	641522	32,33,34,36,39,42,45,54
20 AWG 0.5-0.6 mm ²	641436	32,33,34,36,39,42,45,54	641523	32,33,34,36,39,42,45,54
22 AWG 0.3-0.4 mm ²	641437	32,33,34,36,39,42,45,54	641524	32,33,34,36,39,42,45,54
24 AWG 0.2 mm ²	641438	32,33,34,36,39,42,45,54	641525	32,33,34,36,39,42,45,54
26 AWG 0.12-0.15 mm ²	641439	32,33,34,36,39,42,45,54	641526	32,33,34,36,39,42,45,54
Standard UL 94V-2, .000030 [0.00076] Gold Plated				
18 AWG 0.8-0.9 mm ²	644807	32,33,34,36,39,42,45,54	644812	32,33,34,36,39,42,45,54
20 AWG 0.5-0.6 mm ²	— ²	—	— ²	—
22 AWG 0.3-0.4 mm ²	644809	32,33,34,36,39,42,45,54	644814	32,33,34,36,39,42,45,54
24 AWG 0.2 mm ²	— ²	—	— ²	—
26 AWG 0.12-0.15 mm ²	— ²	—	— ²	—
Standard UL 94V-2, .000015 [0.00038] Gold Plated				
18 AWG 0.8-0.9 mm ²	647476	32,33,34,36,39,42,45,54	647481	32,33,34,36,39,42,45,54
22 AWG 0.3-0.4 mm ²	643995	32,33,34,36,39,42,45,54	647497	32,33,34,36,39,42,45,54

Connector Ordering Information

The “Base Part Numbers” Chart at right shows the base part number and number of circuits available for the described connectors.

Prefixes and suffixes are determined by the number of circuit positions in the connector. For example, the complete part number for a 12-position closed end connector for 18 AWG wire would be:

Base number **641435** plus
prefix-and-suffix
4- -2

The correct ordering number is
4-641435-2

See page 8 for an explanation of RoHS lead free equivalents.

Note: All RoHS equivalent part numbers may not be available upon catalog release. If the number you need is not available, please contact Product Engineering to expedite your request.

Color Coding by Wire Size for UL94V-2 Connectors

- 18 AWG**—Orange
- 20 AWG**—Yellow
- 22 AWG**—Red
- 24 AWG**—White
- 26 AWG**—Blue

Performance Data

- Voltage Rating**—600 vac
- Current Rating**—7 amp max.
- Low-Level Resistance**—7 mΩ max. initial
- Dielectric Withstanding Voltage**—1500 vac/1 min.
- Insulation Resistance**—5000 MΩ min. initial
- Operating Temperature**—-55° C to +105° C

Technical Documents

Product Specification

108-1065 MTA-156 Posted Connector

Application Specification

114-1020 MTA-156 Connectors, Posted Connectors and Card Edge Connectors

Replacement IDC Contacts Material and Finish

Contacts — Copper alloy, post tin plated over nickel

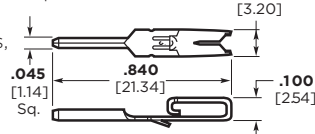

¹ MTA-156 Posted Connectors (Closed End and Feed-Thru) **will Only mate** with MTA-156 connectors with locking ramp and without polarizing tabs. They **will NOT mate** with MTA-156 Quad Connectors.
² Parts can be made available upon request. Minimums may apply.

No. of Circuits	Dim.		Suffix	No. of Circuits	Dim.		Prefix/Suffix
	A	B			A	B	
2	.468 11.89	.316 8.03	-2	9	1.560 39.62	1.408 35.76	-9
3	.624 15.85	.472 11.99	-3	12	2.028 51.51	1.876 47.65	1- -2
4	.780 19.81	.628 15.95	-4	15	2.496 63.40	2.344 59.54	1- -5
6	1.092 27.74	.940 23.88	-6	24	3.900 99.06	3.748 95.20	2- -4

AWG	Wire Size		Part Numbers
	mm ²		
18	0.8-0.9		3-641425-1
20	0.5-0.6		3-641426-1
22	0.3-0.4		3-641427-1
24	0.2		3-641428-1
26	0.12-0.15		3-641429-1

MTA-156 Flat Headers—Straight

Material and Finish

Housing—UL94V-0 rated, polyester, white

Posts—Copper alloy, tin plated .000030 [0.00076] or .000015 [0.00038] gold over nickel

Notes:

1. Post(s) can be omitted for keying purposes. Specify the desired post(s) to be omitted using the figure to identify Post No. 1.
2. Gold headers are duplex plated, gold on mating end of post and tin on the solder tail.
3. .125 [3.18] solder tail lengths are for .062 [1.57] thick printed circuit boards and .175 [4.45] solder tail lengths are for .093-.125 [2.36- 3.18] thick printed circuit boards.
4. To determine header overall length (Dim. A), multiply .156 x the number of posts. Example: .156 x 10 posts equals 1.560 inches [39.62 mm].

For mateability options, see matrix on pages 27, 28, and 47.

For mating half visuals, see pages 29 thru 32, 49 and 51.

Header Ordering Information

The “Base Part Numbers” Chart at right shows the base part number and number of posts available for the described headers.

Prefixes and suffixes are determined by the number of post positions in the header. For example, the complete part number for a 10-position header with square posts and a .125 [3.18] solder tail length would be:

Base number **640383** plus prefix-and-suffix **4- - -0**

The correct ordering number is **4-640383-0**

The part numbers in **bold face** are the RoHS equivalent version. Example:

No. of Pos.	Lead Free RoHS Prefix/Suffix
2	3-640383-2
	thru
24	5-640383-4

See page 8 for an explanation of RoHS lead free equivalents.

Note: All RoHS equivalent part numbers may not be available upon catalog release. If the number you need is not available, please contact Product Engineering to expedite your request.

Note:

Select load headers (omitted pin headers) are available upon request. Please contact product engineer or product manager for details.



Note: Consult Product Drawing for details on placing headers onto PC boards.

Base Part Numbers

Square Posts				Round Posts			
.125 [3.18] Solder tail		.175 [4.45] Solder tail		.125 [3.18] Solder tail		.175 [4.45] Solder tail	
Header Part Nos.	RoHS Equiv.	Header Part Nos.	RoHS Equiv.	Header Part Nos.	RoHS Equiv.	Header Part Nos.	RoHS Equiv.
Standard UL94V-0, Tin Plated							
640383	2-24	644749	2-24	640384	2-24	644750	2-24
Standard UL94V-0, .000030 [0.00076] Gold Plated							
641202	32-54	644756	32-54	641203	32-54	—	—
Standard UL94V-0, .000015 [0.00038] Gold Plated							
641113	32-54	644763	32-54	—	—	—	—

MTA-156 Flat Headers—Right-Angle

Material and Finish

Housing—UL94V-0 rated, polyester, white

Posts—Copper alloy, tin plated .000030 [0.00076] or .000015 [0.00038] gold over nickel

Notes:

1. Post(s) can be omitted for keying purposes. Specify the desired post(s) to be omitted using the figure to identify Post No. 1.
2. Gold headers are duplex plated, gold on mating end of post and tin on the solder tail.
3. .125 [3.18] solder tail lengths are for .062 [1.57] thick printed circuit boards and .175 [4.45] solder tail lengths are for .093-.125 [2.36- 3.18] thick printed circuit boards.
4. To determine header overall length (Dim. A), multiply .156 x the number of posts. Example: .156 x 10 posts equals 1.560 inches [39.62 mm].

For mateability options, see matrix on pages 27, 28, and 47.

For mating half visuals, see pages 29 thru 32, 49 and 51.

Header Ordering Information

The “Base Part Numbers” Chart at right shows the base part number and number of posts available for the described headers.

Prefixes and suffixes are determined by the number of post positions in the header. For example, the complete part number for a 10-position header with square posts and a .125 [3.18] solder tail length would be:

Base number **641204** plus
prefix-and-suffix
4- -0

The correct ordering number is
4-641204-0

The part numbers in **bold face** are the RoHS equivalent version. Example:

No. of Pos.	Lead Free RoHS Prefix/Suffix
2	3-641204-2
	thru
24	5-641204-4

See page 8 for an explanation of RoHS lead free equivalents.

Note: All RoHS equivalent part numbers may not be available upon catalog release. If the number you need is not available, please contact Product Engineering to expedite your request.

Note:

Select load headers (omitted pin headers) are available upon request. Please contact product engineer or product manager for details.

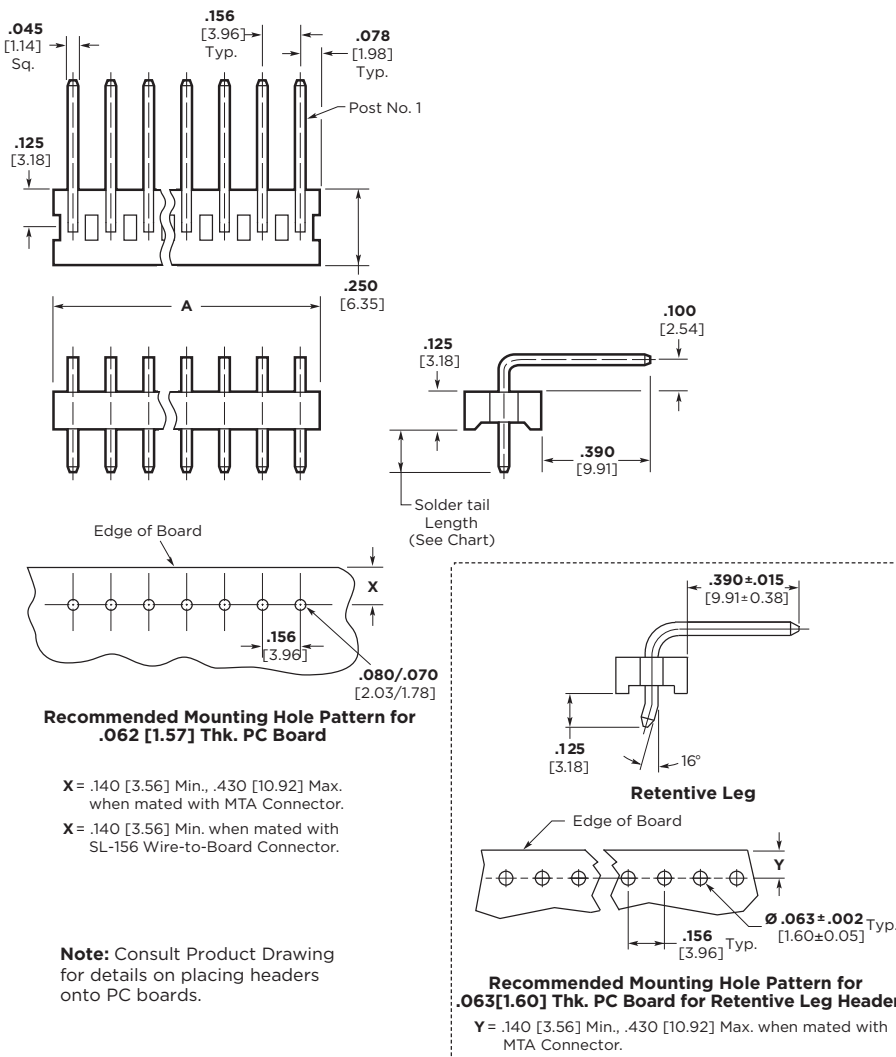

Base Part Numbers

Retentive Leg		Square Posts		Retentive Leg	
Header Part Nos.	RoHS Equiv.	Header Part Nos.	RoHS Equiv.	Header Part Nos.	RoHS Equiv.
Standard UL94V-0, Tin Plated					
647646	2-12	640385	2-24	644751	2-24
Standard UL94V-0, .000030 [0.00076] Gold Plated					
—	—	641204	32-54	—	—
Standard UL94V-0, .000015 [0.00038] Gold Plated					
—	—	—	—	—	—

MTA-156 Friction Lock Headers—Straight

Material and Finish

Housing—UL94V-0 rated, polyester, white

Posts—Copper alloy, tin plated .000030 [0.00076] or .000015 [0.00038] gold over nickel

Notes:

1. Post(s) can be omitted for keying purposes. Specify the desired post(s) to be omitted using the figure to identify Post No. 1.
2. Gold headers are duplex plated, gold on mating end of post and tin on the solder tail.
3. .125 [3.18] solder tail lengths are for .062 [1.57] thick printed circuit boards and .175 [4.45] solder tail lengths are for .093-.125 [2.36- 3.18] thick printed circuit boards.
4. To determine header overall length (Dim. A), multiply .156 x the number of posts. Example: .156 x 10 posts equals 1.560 inches [39.62 mm].

For mateability options, see matrix on pages 27, 28, and 47.

For mating half visuals, use connectors with a locking ramp for polarization/retention purposes, see pages 29 thru 32, 48, 53 and 55.

For polarizing purposes only use connectors without a locking ramp. See pages 29 thru 32, 49 and 51.

Header Ordering Information

The “Base Part Numbers” Chart at right shows the base part number and number of posts available for the described headers.

Prefixes and suffixes are determined by the number of post positions in the header. For example, the complete part number for a 10-position header with square posts and a .125 [3.18] solder tail length would be:

Base number **641208** plus prefix-and-suffix **4- - -0**

The correct ordering number is **4-641208-0**

All part numbers in **bold face** are the RoHS equivalent version. Example:

No. of Pos.	Standard Prefix/Suffix	Lead Free RoHS Prefix/Suffix
2	641208-2	3-641208-2
thru		
24	2-641208-4	5-641208-4

See page 8 for an explanation of RoHS lead free equivalents.



Recommended Mounting Hole Pattern for .062 [1.57] Thk. PC Board

PC Board Hole Diameters	
Square Post	Round Post
.080/.070 [2.03/1.78]	.070/.060 [1.78/1.52]

Note: Consult Product Drawing for details on placing headers onto PC boards.

Base Part Numbers

Retentive Leg		Square Posts				Round Posts			
		.125 [3.18] Solder tail		.175 [4.45] Solder tail		.125 [3.18] Solder tail		.175 [4.45] Solder tail	
Header Part Nos.	RoHS Equiv.	Header Part Nos.	RoHS Equiv.	Header Part Nos.	RoHS Equiv.	Header Part Nos.	RoHS Equiv.	Header Part Nos.	RoHS Equiv.
Standard UL94V-0, Tin Plated									
1744017	2	640445	2-24	644752	2-24	640388	2-24	644753	2-24
Standard UL94V-0, .000030 [0.00076] Gold Plated									
—	—	641208	32-54	644759	32-54	641209	32-54	644760	32-54
Standard UL94V-0, .000015 [0.00038] Gold Plated									
—	—	641119	32-54	644766	32-54	641120	32-54	644767	32-54

Note: All RoHS equivalent part numbers may not be available upon catalog release. If the number you need is not available, please contact Product Engineering to expedite your request.

Note:

Select load headers (omitted pin headers) are available upon request. Please contact product engineer or product manager for details.

MTA-156 Friction Lock Headers—Right-Angle

Material and Finish

Housing—UL94V-0 rated, polyester, white

Posts—Copper alloy, tin plated .000030 [0.00076] or .000015 [0.00038] gold over nickel

Notes:

1. Post(s) can be omitted for keying purposes. Specify the desired post(s) to be omitted using the figure to identify Post No. 1.
2. Gold headers are duplex plated, gold on mating end of post and tin on the solder tail.
3. .125 [3.18] solder tail lengths are for .062 [1.57] thick printed circuit boards and .175 [4.45] solder tail lengths are for .093-.125 [2.36- 3.18] thick printed circuit boards.
4. To determine header overall length (Dim. A), multiply .156 x the number of posts. Example: .156 x 10 posts equals 1.560 inches [39.62 mm].

For mateability options, see matrix on pages 27, 28, and 47.

When using Front Bend Headers—for mating half visuals use connectors with a locking ramp for polarization/ retention purposes. When using Rear Bend Headers—for mating half visuals use connectors without a locking ramp. For polarization purposes only see pages 29 thru 32, 49 and 51.

Header Ordering Information

The “Base Part Numbers” Chart at right shows the base part number and number of posts available for the described headers.

Prefixes and suffixes are determined by the number of post positions in the header. For example, the complete part number for a 10-position header with square posts, front bend, and a .125 [3.18] solder tail length would be:

Base number **641210** plus prefix-and-suffix **4- - -0**

The correct ordering number is **4-641210-0**

All part numbers in **bold face** are the RoHS equivalent version. Example:

No. of Pos.	Standard Prefix/Suffix	Lead Free RoHS Prefix/Suffix
2	641210-2	3-641210-2
thru		
24	2-641210-4	5-641210-4

See page 8 for an explanation of RoHS lead free equivalents.



Base Part Numbers

Square Posts							
Front Bend				Rear Bend			
.125 [3.18] Solder tail		.175 [4.45] Solder tail		.125 [3.18] Solder tail		.175 [4.45] Solder tail	
Header Part Nos.	RoHS Equiv.	Header Part Nos.	RoHS Equiv.	Header Part Nos.	RoHS Equiv.	Header Part Nos.	RoHS Equiv.
Standard UL94V-0, Tin Plated							
640389	2-24	644754	2-24	640387	2-24	644755	2-24
Standard UL94V-0, .000030 [0.00076] Gold Plated							
641210	32-54	644761	32-54	641207	32-54	—	—
Standard UL94V-0, .000015 [0.00038] Gold Plated							
641121	32-54	644768	32-54	—	—	644769	32-54

Note: All RoHS equivalent part numbers may not be available upon catalog release. If the number you need is not available, please contact Product Engineering to expedite your request.

Note:

Select load headers (omitted pin headers) are available upon request. Please contact product engineer or product manager for details.

MTA-156 Polarized Lock Headers—Straight

Material and Finish

Housing—UL94V-0 rated, polyester, white

Posts—Copper alloy, tin plated .000030 [0.00076] gold over nickel

Notes:

1. Post(s) can be omitted for keying purposes. Specify the desired post(s) to be omitted using the figure to identify Post No. 1.
2. Peg holes are not required in PC Boards when headers without pegs are used.
3. One peg only on a 2 position header, other position sizes have two pegs.
4. Headers with .00015 [0.00038] gold plated post are available upon request. Minimums may apply.
5. To determine header overall length (Dim. A), multiply .156 x the number of posts. Example: .156 x 10 posts equals 1.560 inches [39.62 mm].

For mateability options, see matrix on pages 27, 28, and 47.

For mating half visuals, use connectors with a locking ramp for polarization/retention purposes, see pages 29 thru 32, 53 and 55.

For por polarizing purposes only use connectors without a locking ramp. See pages 29 thru 32, 49 and 51.

Header Ordering Information

The “Base Part Numbers” Chart at right shows the base part number and number of posts available for the described headers.

Prefixes and suffixes are determined by the number of post positions in the header. For example, the complete part number for a 10-position header with square posts with pegs would be:

Base number **644615** plus prefix-and-suffix **4- - -0**

The correct ordering number is **4-644615-0**

All part numbers in **bold face** are the RoHS equivalent version. Example:

No. of Pos.	Lead Free RoHS Prefix/Suffix
2	3-644615-2
	thru
18	4-644615-8

See page 8 for an explanation of RoHS lead free equivalents.



Recommended Mounting Hole Pattern for .062 [1.57] Thk. PC Board

PC Board Hole Diameters	
Square Post	Round Post
.069/.065 [1.75/1.65]	.054/.050 [1.37/1.27]

Note: Consult Product Drawing for details on placing headers onto PC boards.

Base Part Numbers

Square Posts				Round Posts			
Without Pegs		With Pegs		Without Pegs		With Pegs	
Header Part Nos.	RoHS Equiv.	Header Part Nos.	RoHS Equiv.	Header Part Nos.	RoHS Equiv.	Header Part Nos.	RoHS Equiv.
Standard UL94V-0, Tin Plated							
644611	32-35	644615	32-48	—	—	—	—
Standard UL94V-0, .000030 [0.00076] Gold Plated							
644627	32-48	644631	32-35	—	—	—	—

Note: All RoHS equivalent part numbers may not be available upon catalog release. If the number you need is not available, please contact Product Engineering to expedite your request.

Note:

Select load headers (omitted pin headers) are available upon request. Please contact product engineer or product manager for details.

MTA-156 Polarized Lock Headers—Right-Angle

Material and Finish

Housing—UL94V-0 rated, polyester, white

Posts—Copper alloy, tin plated .000030 [0.00076] gold over nickel

Notes:

1. Post(s) can be omitted for keying purposes. Specify the desired post(s) to be omitted using the figure to identify Post No. 1.
2. Peg holes are not required in PC Boards when headers without pegs are used.
3. One peg only on a 2 position header, other position sizes have two pegs.
4. Headers with .00015 [0.00038] gold plated post are available upon request. Minimums may apply.
5. To determine header overall length (Dim. A), multiply .156 x the number of posts. Example: .156 x 10 posts equals 1.560 inches [39.62 mm].

For mateability options, see matrix on pages 27, 28, and 47.

For mating half visuals, use connectors with a locking ramp for polarization/retention purposes, see pages 29 thru 32, 53 and 55.

For polarizing purposes only use connectors without a locking ramp. See pages 29 thru 32, 49 and 51.



Header Ordering Information

The “Base Part Numbers” Chart at right shows the base part number and number of posts available for the described headers.

Prefixes and suffixes are determined by the number of post positions in the header. For example, the complete part number for a 10-position header with front bend and with pegs would be:

Base number **644617** plus prefix-and-suffix **4- -0**

The correct ordering number is **4-644617-0**

All part numbers in **bold face** are the RoHS equivalent version. Example:

No. of Pos.	Lead Free RoHS Prefix/Suffix
2	3-644617-2
	thru
18	4-644617-8

See page 8 for an explanation of RoHS lead free equivalents.

Recommended Mounting Hole Pattern for .062 [1.57] Thk. PC Board

Note: Consult Product Drawing for details on placing headers onto PC boards.

Base Part Numbers

Square Posts					
Front Bend				Rear Bend	
Without Pegs		With Pegs		Without Pegs	
Header Part Nos.	RoHS Equiv.	Header Part Nos.	RoHS Equiv.	Header Part Nos.	RoHS Equiv.
Standard UL94V-0, Tin Plated					
644613	32-48	644617	32-48	—	—
Standard UL94V-0, .000030 [0.00076] Gold Plated					
—	—	644633	32-48	—	—

Note: All RoHS equivalent part numbers may not be available upon catalog release. If the number you need is not available, please contact Product Engineering to expedite your request.

Note:

Select load headers (omitted pin headers) are available upon request. Please contact product engineer or product manager for details.

MTA-156 Friction Lock High Temperature Headers—Straight

Material and Finish

Housing—UL94V-0 rated, nylon, black
Posts—Copper alloy, tin plated .000015 [0.00038] gold over nickel
Temperature—Maximum Temperature Rating: 280°C

Notes:

1. Post(s) can be omitted for keying purposes. Specify the desired post(s) to be omitted using the figure to identify Post No. 1.
2. Gold headers are duplex plated, gold on mating end of post and tin-lead on the solder tail.
3. Headers with straight and right-angle square posts are available upon request. Minimums may apply.
4. To determine header overall length (Dim. A), multiply .156 x the number of posts. Example: .156 x 10 posts equals 1.560 inches [39.62 mm].

For mateability options, see matrix on pages 27, 28, and 47.

For mating half visuals, use only connectors with a locking ramp for polarization/retention purposes, see pages 29 thru 32, 53 and 55.

For polarizing purposes only use connectors without a locking ramp. See pages 29 thru 32, 49 and 51.

Header Ordering Information

The “Base Part Numbers” Chart at right shows the base part number and number of posts available for the described headers.

Prefixes and suffixes are determined by the number of post positions in the header. For example, the complete part number for a 10-position header with round tin plated posts:

Base number **647648** plus prefix-and-suffix **4- -0**

The correct ordering number is **4-647648-0**

All part numbers in **bold face** are the RoHS equivalent version. Example:

No. of Pos.	Lead Free RoHS Prefix/Suffix
2	3-647648-2
	thru
18	4-647648-2

See page 8 for an explanation of RoHS lead free equivalents.

For use with Infrared Reflow Process



Recommended Mounting Hole Pattern for .062 [1.57] Thick PC Board

Note: Consult Product Drawing for details on placing headers onto PC boards.

Base Part Numbers

Round Post	
Header Part Nos.	RoHS Equiv.
Standard UL94V-0, Tin Plated	
647648	32-42
Standard UL94V-0, .000015 [0.00038] Gold Plated	
647649	32-42

Note: All RoHS equivalent part numbers may not be available upon catalog release. If the number you need is not available, please contact Product Engineering to expedite your request.

Note:

Select load headers (omitted pin headers) are available upon request. Please contact product engineer or product manager for details.

MTA-156 Shrouded Headers—Straight and Right-Angle

Material and Finish

Housing—UL94V-0 rated, polyester, black

Posts—Copper alloy, tin plated; or .000030 [0.00076] or .000015 [0.00038] gold over nickel

Notes:

1. Post(s) can be omitted for keying purposes. Specify the desired post(s) to be omitted using the figure to identify Post No. 1.
2. Gold headers are duplex plated, gold on mating end of post and tin-lead on the solder tail.
3. Peg holes are not required in PC boards when headers without pegs are used.
4. One peg only on a 2 position header, other position sizes have two pegs.
5. Right-angle front and rear bend headers with retention pegs can be made available upon request. Minimums may apply.

For mateability options, see matrix on pages 27, 28, and 47.

For mating half visuals, see pages 29 thru 32.

Header Ordering Information

The “Base Part Numbers” Chart at right shows the base part number and number of posts available for the described headers.

Prefixes and suffixes are determined by the number of post positions in the header. For example, the complete part number for a 10-position header with straight, square posts and with pegs would be:

Base number **647127** plus prefix-and-suffix **4- -- -0**

The correct ordering number is **4-647127-0**

No. of Pos.	Dim. A	RoHS Prefix/Suffix
2	.406 10.31	2--2
3	.562 14.27	2--3
4	.718 18.24	2--4
5	.874 22.20	2--5
6	1.030 26.16	2--6
7	1.186 30.12	2--7
8	1.342 34.09	2--8
9	1.498 38.05	2--9
10	1.654 42.01	3--0
11	1.810 45.97	3--1
12	1.966 49.94	3--2

All RoHS equivalent part numbers may not be available upon catalog release. If the number you need is not available, please contact Product Engineering to expedite your request.

Straight Post (.045 [1.14] Square or Round)

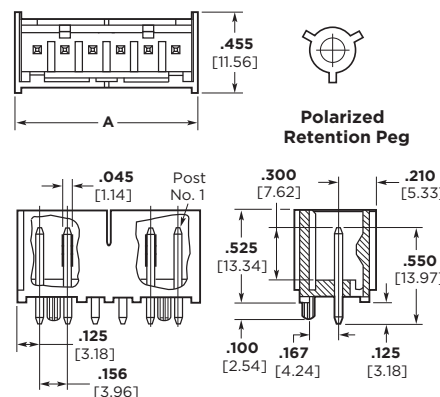

PC Board Hole Diameters

Square Post	Round Post
.069/.065 [1.75/1.65]	.054/.050 [1.37/1.27]

Note: Consult Product Drawing for details on placing headers onto PC boards.

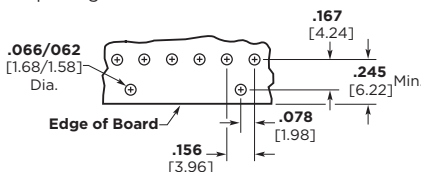

Recommended Mounting Hole Pattern for .062 [1.57] Thick PC Board Using a Straight Post Header

Right-Angle (.045 [1.14] Square)

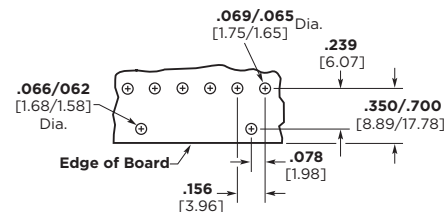
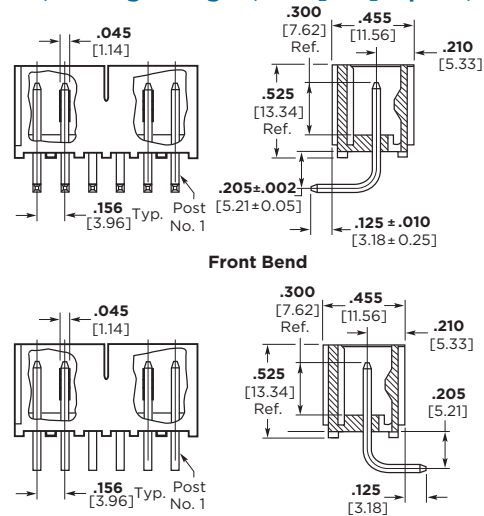

Recommended Mounting Hole Pattern for .062 [1.57] Thick PC Board Using a Right-Angle Header

Base Part Numbers

Straight Square Posts				Straight Round Posts			
Without Pegs		With Pegs		Without Pegs		With Pegs	
Header Part Nos.	RoHS Equiv.	Header Part Nos.	RoHS Equiv.	Header Part Nos.	RoHS Equiv.	Header Part Nos.	RoHS Equiv.
Standard UL94V-0, Tin Plated							
647123	22-32	647127	22-32	—	—	—	—
Standard UL94V-0, .000030 [0.00076] Gold Plated							
—	—	—	—	—	—	—	—
Standard UL94V-0, .000015 [0.00038] Gold Plated							
—	—	—	—	—	—	—	—
Square Posts							
Right-Angle Posts, Front Bend Without Pegs				Right-Angle Posts, Rear Bend Without Pegs			
Header Part Nos.	RoHS Equiv.	Header Part Nos.	RoHS Equiv.	Header Part Nos.	RoHS Equiv.	Header Part Nos.	RoHS Equiv.
Standard UL94V-0, Tin Plated							
647125	22-32	—	—	—	—	—	—
Standard UL94V-0, .000030 [0.00076] Gold Plated							
—	—	—	—	—	—	—	—
Standard UL94V-0, .000015 [0.00038] Gold Plated							
—	—	—	—	—	—	—	—

Note: Select load headers (omitted pin headers) are available upon request. Please contact product engineer or product manager for details.

.156 [3.96] Centerline SL-156 Crimp Contacts and Housings

PRODUCT FACTS

- Rugged wire-to-board interconnection to mate with .045 square or round post headers or staked posts on .156 centers
- Standard Connectors accept wire range of 18–24 AWG [0.9–0.2 mm] and LID Connectors accept wire range of 18–24 AWG [0.9–0.2 mm] and a limited 16 AWG [1.29–1.42 mm] (2550–2800 CMA)
- Two-piece interconnection system (connector/header)
- Housing made of flame retardant nylon
- Available in 1- through 24-position connector configurations
- Connectors are end-to-end stackable
- Wire-to-board system offers polarization with friction lock for positive mating
- Meets the material requirements of Table 23.1 of UL1410 Standard for High-Voltage Television Receivers and Video Productions
- Recognized under the Component Program of Underwriters Laboratories Inc., File No. E28476
- Certified by Canadian Standards Association, File No. LR7189



The AMP SL-156 connectors shown on the following pages are designed to mate with .045 [1.14] square or round post headers or staked posts on .156 [3.96] centers.

The wire-to-board connector is a two-piece connector system with the wire crimped to the contact, then inserted into the housing. This product mates with the MTA-156 flat, polarized and friction lock header, or staked posts (**not** MTA-156 shrouded headers).

Performance Data*

Voltage Rating—250 vac

Current Rating—10 amp max. at 250 vac

Low-Level Resistance—3.0 mΩ max. initial

Dielectric Withstanding Voltage—2000 vac/1 min.

Insulation Resistance—1000 MΩ min. initial

Operating Temperature—–55° C to +105° C

The Large Insulation Diameter (LID) Contacts and Housings are for use in applications where wire insulation is up to .112 [2.84] in diameter.

These matrices represent only the housing and header combinations. You also need to consider the plating on the contacts and headers. Gold contacts with gold headers and tin contacts with tin headers.

Matrix for Tin Plated Part Numbers

Housings	Standard	LID	Headers																										
			640385	640384	640385	640387	640388	640389	640445	644611	644612	644613	644614	644615	644616	644617	644749	644750	644751	644752	644753	644754	644755	647227	647228	647229	647230	647260	647262
640250	647401		Y	N	Y	Y	Y	Y	Y	Y	Y	Y	Y	Y	Y	Y	Y	Y	Y	Y	Y	Y	Y	Y	Y	Y	Y	Y	Y
640251	647400		Y	Y	Y	Y	Y	Y	Y	Y	Y	Y	Y	Y	Y	Y	Y	Y	Y	Y	Y	Y	Y	Y	Y	Y	Y	Y	Y
770849	647402		Y	N	Y	Y	Y	Y	Y	Y	Y	Y	Y	Y	Y	Y	Y	Y	Y	Y	Y	Y	Y	Y	Y	Y	N	Y	Y

Matrix for .00030 [0.00076] Gold Plated Part Numbers

Housings	Standard	LID	Headers																									
			641202	641203	641204	641207	641208	641209	641210	644627	644628	644629	644630	644631	644632	644633	644756	644757	644758	644759	644760	644761	644762					
640250	647401		Y	Y	Y	N	Y	Y	Y	Y	Y	Y	N	Y	Y	Y	Y	Y	Y	Y	Y	Y	Y	Y	Y	Y	Y	N
640251	647400		Y	Y	Y	Y	Y	Y	Y	Y	Y	Y	Y	Y	Y	Y	Y	Y	Y	Y	Y	Y	Y	Y	Y	Y	Y	Y
770849	647402		Y	Y	Y	N	Y	Y	Y	Y	Y	Y	N	Y	Y	Y	Y	Y	Y	Y	Y	Y	Y	Y	Y	Y	Y	N

Matrix for .00015 [0.00038] Gold Plated Part Numbers

Housings	Standard	LID	Headers															
			641113	641114	641115	641118	641119	641120	641121	644322	644763	644764	644765	644766	644767	644768	644769	647261
640250	647401		Y	Y	Y	N	Y	Y	Y	Y	Y	Y	Y	Y	Y	Y	N	Y
640251	647400		Y	Y	Y	Y	Y	Y	Y	Y	Y	Y	Y	Y	Y	Y	Y	Y
770849	647402		Y	Y	Y	N	Y	Y	Y	Y	Y	Y	Y	Y	Y	N	Y	

SL-156 Crimp Contacts and Keying Plugs

Contacts

Material and Finish

.012 [0.3] bright tin plated brass or phosphor bronze; .012 [0.3] pre-tin brass; or .012 [0.3] brass or phosphor bronze with .000030 [0.00076] gold over nickel (see chart)

- All tin-plated contacts are post lubricated to resist fretting corrosion
- Maximum insulation diameter is .105 [2.67]
- Wire range is 18-30 AWG [0.9-0.06 mm²]

Application Note

Part No. 640252 has a higher mating and unmating force than Part No. 350980 and is recommended to be used only in housings with 1 through 12 positions.

Part No. 350980 can be used in any size housing but is recommended to be used in housings with 13 through 24 positions. Part No. 770476 is recommended for use in any size housing. Its mating force is similar to Part No. 350980 while unmating force is similar to 640252.

For housings, see pages 49 and 50.

Keying Plugs

Material (RoHS Compliant)

UL94V-2 rated, nylon, natural color

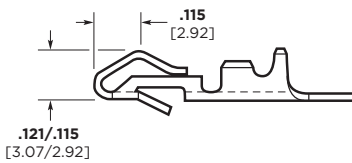

A
High Force
(6.5 Amp Max. Current Rating)

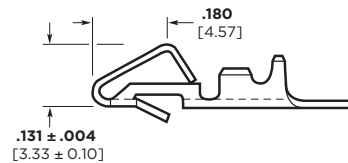

B
Low Force
(6.5 Amp Max. Current Rating)

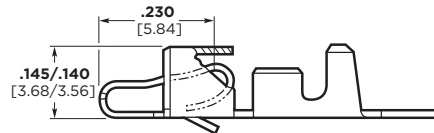

C
Hooded (Dual Wipe)
(10 Amp. Max. Current Rating)

Wire Size AWG mm ²	Contact	Material and Finish	Part Numbers	
			Strip	Loose Piece
24-30 0.2-0.06	A	brass, pre-tin plated	641550-1	—
		brass, bright tin plated	640252-1	640706-1
18-24 0.9-0.2	A	brass, pre-tin plated	640252-2	640706-2
		brass, RoHS Compliant	3-640252-1	3-640706-1
		brass, bright tin plated	350980-1	640707-1
	B	brass, pre-tin plated	350980-2	—
		brass, gold plated	350980-3	770258-1
		brass, RoHS Compliant	3-350980-1	3-640707-1
	C	phosphor bronze, bright tin plated	770476-1	770522-1
		phosphor bronze, gold plated	770476-2	770522-2
		phosphor bronze, RoHS Compliant	3-770476-1	3-770522-1

Application Tooling

Extraction Tool
Part No. 90471-1

Loose Piece Contacts

PRO-CRIMPER II Hand Tool
Part No. 58614-1 (408-4228)
[For field service use only]
For CERTI-CRIMP hand tool,
contact Technical Support.

Strip Contacts —

AMP-O-LECTRIC Model “G”
Termination Machine*
Applicator 680211-3
(Request Catalog 65828)
AMP-O-LECTRIC Model “K”
Termination Machine* Applicator
466468-2
AMP-O-MATIC Stripper-Crimper
Machine* SCA 466947-1 or 567828-1
(with CQM) (Request Catalog 65004)
AMPOMATOR CLS IV+ Lead Making
Machine* Applicator 466468-1
(Request Catalog 82659)

*Requires applicators. For part numbers, call Technical Support.

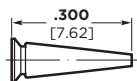

Keying Plug
Part No. 640254-1

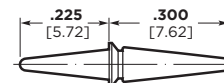

Keying Pin
Part No. 640255-1

SL-156 Housings—Wire-to-Board

Housings

Material (RoHS Compliant)

UL94V-0 rated, nylon, white

Notes:

1. Accepts either .045 [1.14] square or round posts. Housings mate with flat and friction lock headers, or staked posts on .156 [3.96] centers.
2. Housings without ramp, with polarizing tab, available upon request. Minimums may apply.
3. Recommend contact: Part No. 640252 for 1 thru 12 positions; Part No. 350980 for 13 thru 24 positions; Part No. 770476 for 1 thru 24 positions.

For contacts, see page 48.

For mateability options, see matrix on page 47.

For mating half visuals, for connectors with locking ramp, see pages 39, 36, 41, 43 and 45, (41 and 44 Front Bend Headers only.)

For mating half visuals, for connectors without locking ramp, see pages 35 thru 45.



(A) With Locking Ramp/With Polarizing Tabs



(B) With Locking Ramp/Without Polarizing Tabs



(C) Without Locking Ramp/Without Polarizing Tabs

Note: Dim. A = 0.156 × (No. of Positions - 1) + 0.152

No. of Positions*	Housing	Description	Part Numbers*
2-24	A	With Locking Ramp and Polarizing Tabs	770849
1-24	B	With Locking Ramp and without Polarizing Tabs	640250
	C	Without Locking Ramp or Polarizing Tabs	640251

*Base Part Number Prefixes and Suffixes indicate number of contact positions, e.g. 2 Position = 0-xxxxxx-2 and 12 Position = 1-xxxxxx-2.

Note: Housings not for use with LID Contacts. Shown on page 51.

SL-156 Housings With Through Board Latch

Housings

Material (RoHS Compliant)
UL94V-0 rated, nylon, white.



Mates with .045 square or round staked posts only.

For contacts, see page 48.



**Recommended PC Board Cutout
for .062 [1.57] Thick PC Board**

No. of Pos.	Dimensions		Latch Location Centered Between Pos.	Part Number
	A	B		
2	.312 7.92	—	1 and 2	770894-2
3	.468 11.89	—	1 and 2	770894-3
4	.624 15.85	—	2 and 3	770894-4
5	.780 19.81	—	2 and 3	770894-5
6	.936 23.77	—	3 and 4	770894-6
7	1.092 27.74	—	3 and 4	770894-7
8	1.248 31.70	—	4 and 5	770894-8
9	1.404 35.66	1.092 27.74	1 and 2 & 8 and 9	770894-9
10	1.560 39.62	1.248 31.70	1 and 2 & 9 and 10	1-770894-0

Note: Not for use with LID Contacts.

SL-156 Housings and Contacts for Large Insulation Diameter (LID) Wire

Housings

Material (RoHS Compliant)

UL94V-0 rated, nylon, white

Notes:

1. Accepts Standard and LID contacts.
2. Larger opening in housings eases contact insertion when using wires that have large insulation diameters (.100-.112 [2.54-2.84]).
3. Housings are not End-to-End stackable.

For mateability options, see matrix on page 47.

For mating half visuals, for connectors with locking ramp, see pages 39, 40, 41, 43 and 49, (42 and 44 Front Bend Headers only.)

For mating half visuals, for connectors without locking ramp, see pages 39 thru 45.

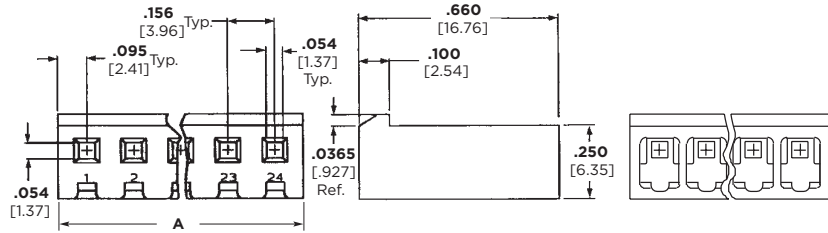

Note: Dim. A = 0.156 × (No. of Positions - 1) + 0.19

No. of Positions*	Description	Part Numbers*
		Housings with Larger Openings for Oversize Wire
1-24	Without Locking Ramp or Polarizing Tabs	647400
	With Locking Ramp and without Polarizing Tabs	647401 (shown above)
2-24	With Locking Ramp and Polarizing Tabs	647402

*Base Part Number Prefixes and Suffixes indicate number of contact positions, e.g. 2 Position = 0-xxxxxx-2 and 12 Position = 1-xxxxxx-2.

Contacts

Material and Finish

.012 [0.3] bright tin plated phosphor bronze; .012 [0.3] phosphor bronze with .000030 [0.00076] gold over nickel (see chart)

- All tin-plated contacts are post lubricated to resist fretting corrosion
- Maximum insulation diameter is .112 [2.85]
- Wire range is 18-24 AWG [0.9-0.2 mm²] and a limited 16 AWG [1.29-1.42 mm²] (2550-2800 CMA)

Product Specifications

108-1049-1 and 108-1049-2

Application Specification

114-1021

Application Tooling

Extraction Tool Part No. 90471-1

Loose Piece Contacts –

PRO-CRIMPER II Hand Tool
Part No. 91368-1 [18-24 AWG]
Part No. 91369-1 [16 AWG]
(For field service use only.)
For CERTI-CRIMP hand tool, contact Technical Support.

Strip Contacts –

AMP-O-LECTRIC Model “G”
Termination Machine*
Applicator 1385048-3 [18-24 AWG]
Applicator 1385219-3 [16 AWG]
AMP-O-LECTRIC Model “K”
Termination Machine*
Applicator 1385048-2 [18-24 AWG]
Applicator 1385219-2 [16 AWG]

*For additional part numbers and information contact Technical Support.

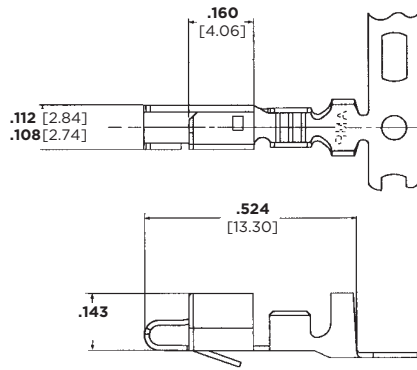

**Hooded (Dual Wipe)
(10 Amp Max. Current Rating)**

Wire Size	Material	Plating	Part Numbers For LID* Wire	
			Strip	Loose Piece
18-24 AWG	Phosphor Bronze	Tin	647406-1	647409-1
		Gold	647406-2	647409-2
		RoHS Compliant	3-647409-1	3-647409-1
16 AWG (2550-2800 CMA only)	Phosphor Bronze	Tin	647466-1	647485-1
		Gold	647466-2	647485-2
		RoHS Compliant	3-647409-1	3-647409-1

*Large Insulation Diameter (.100-.112 [2.54-2.84])

- Notes:** 1. For information on application tooling, call Technical Support.
2. Can **not** be used with Standard SL-156 Housings, must be used with LID Housings only.

MTA Wire Selection

Proper wire selection is critical to the success of a wire-to board application. The chart identifies wires that have been evaluated and approved by the product engineering section. If you plan to use a wire not on the approved list, please submit a sample 12" length of wire to TE for evaluation.

AWG Metric Equivalents

- 18 — 0.8–0.9 mm²
- 20 — 0.5–0.6 mm²
- 22 — 0.3–0.4 mm²
- 24 — 0.2 mm²
- 26 — 0.12–0.15 mm²
- 28 — 0.08–0.09 mm²

Product Specifications

- 108-1050 — MTA-100 Connectors
- 108-1050-1 — MTA-100 Posted Connectors
- 108-1051 — MTA-156 Connectors
- 108-1219 — MTA-156 Quad Connector System
- 108-1065 — MTA-156 Posted Connectors
- 108-1058 — MTA-156 Card Edge Connectors

Application Specifications

- 114-1019 — MTA-100 Connectors
- 114-1020 — MTA-156 Connectors
- 114-1031 — MTA-100 Ribbon Cable Connector Assembly
- 114-1032 — MTA-156 Ribbon Cable Connector Assembly
- 114-1048 — MTA-156 Quad Connector

MTA Connectors Approved Wire Listing

MTA-100 Connectors	Wall	Approved Wire AWG
UL 1007 PVC Insulation	.015" [0.381]	22, 24, 26, 28
UL 1061 Semi-Rigid PVC Insulation	.009" [0.229]	22, 24, 26, 28
UL 1095 Semi-Rigid PVC Insulation	.012" [0.305]	24
UL 1371 TEFLON Insulation — TFE	.006" [0.152]	22, 26
UL 1429 Irradiated PVC — X.L.P.V.C.	.010" [0.254]	22, 24, 26, 28
UL 2464 PVC	.013" [0.330]	24
UL 3265 Irradiated Polyethylene — X.L.P.E.	.010" [0.254]	22, 24
UL 3266 Irradiated Polyethylene — X.L.P.E.	.015" [0.381]	22, 24
MIL-W-16878, Type B-PVC Insulation	.010" [0.254]	22
UL 1213 TEFLON Insulation—T.F.E.	.010" [0.254]	22

MTA-156 Connectors	Wall	Approved Wire AWG
UL 1007 PVC Insulation	.015" [0.381]	18, 20, 22, 24
UL 1061 Semi-Rigid PVC Insulation	.009" [0.229]	18, 20, 22, 24
UL 1180 TEFLON Insulation — T.F.E.	.015" [0.381]	22
UL 1213 TEFLON Insulation — T.F.E.	.010" [0.254]	18, 22, 24
UL 1316 PVC/Nylon Wall	.015" [0.381]	18, 22
UL 1429 Irradiated PVC — X.L.P.V.C.	.010" [0.254]	18, 20, 22, 24
UL 1430 Irradiated PVC — X.L.P.V.C.	.015" [0.381]	18, 20, 22, 24
UL 1569 PVC	.015" [0.381]	18
UL 3265 Irradiated Polyethylene — X.L.P.E.	.010" [0.254]	22
UL 3266 Irradiated Polyethylene — X.L.P.E.	.015" [0.381]	18, 20, 22, 24

Note: When selecting approved wire styles noted on this list, the MTA Application Specifications guidelines must be followed. Also, due to wire variations in insulation wall thickness, hardness and wire stranding we would recommend evaluating the wire selected before final application approval.

TEFLON is a trademark of E.I. DuPont de Nemours and Company.

MTA-100 Ribbon Cable Preparation

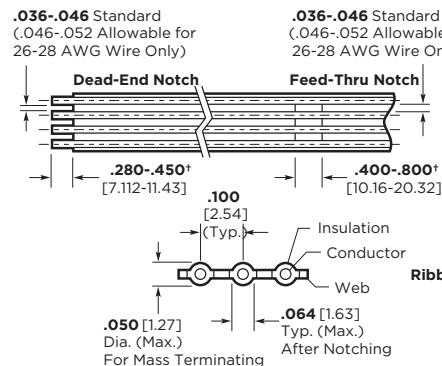

MTA-156 Ribbon Cable Preparation

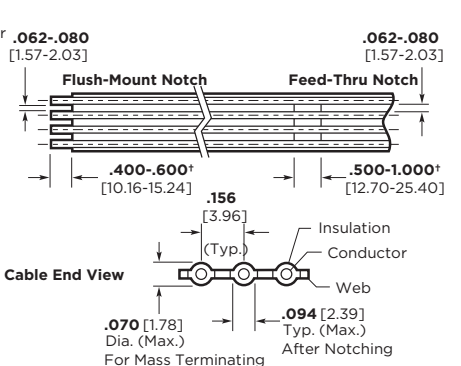

† The dimensions shown represent the recommended minimum and maximum for notches; the actual dimension will depend on your application requirements.

Notes:

- Cable shall be notched, as indicated in the individual ribbon cable connector assembly drawing, according to the requirements specified in these figures. Conductor shall not be exposed after notching, nor shall individual wire stands be cut or nicked.
- U.L. Style #2651 ribbon cable is approved for use with MTA-100 and MTA-156 connectors per Application Specification 114-1031 and 114-1032.

Ribbon Cable

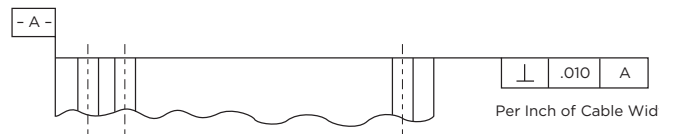

Notes:

- For MTA Cable Assemblies Contact US Engineering Cable Assembly Group.
- For IDC Cable, see pages 60 thru 63.

Cable Edge-to-End Alignment
(Ends of the cable shall be prepared as indicated in this figure)

IDC Ribbon Cable

PRODUCT FACTS

- Compatible with a variety of Insulation Displacement Connectors
- Available on .025 [0.63], .0394 [1.00], .050 [1.27], .100 [2.54] and .156 [3.96] centerline
- Color code edge mark on conductor #1
- Gray flame retardant flexible PVC insulation
- Insulation rated for temperature of -20°C to +105°C
- Recognized under the Component Program of Underwriters Laboratories Inc., File No. E53793



TE has an expanding array of MADISON CABLE planar PVC insulated product designed for compatibility with a variety of Insulation Displacement Connectors. AMP IDC terminations offer a quick, reliable, cost-effective cabling system which can be automated.

The .100 [2.54] centerline cable is available in 28 to 22 AWG, either as tinned or as overcoated tinned wire, in 2 to 28 conductors.

The .156 [3.96] centerline is available in 22 AWG and 18 AWG, either as tinned or overcoated tinned, in 2 to 24 conductors.

IDC Ribbon Cable is produced to tighter standards than usually required for high yield insulation displacement terminations. The extra precision offers uncomplicated operation in fully automatic stripping, notching and termination equipment.

.050 [1.27] Centerline, IDC Ribbon Cable

Product Specifications

Voltage Rating—30 vac

Component Recognized by UL to US and Canadian Standards—AWM Style 2651

Sizes

26 AWG, 7/34 Tinned copper, PVC insulation (9–64 conductors), 500 ft. reels (Base AMP Part Number 57034)

28 AWG, 7/36 Tinned copper, PVC insulation (9–64 conductors), 100 ft. reels (Base AMP Part Number 57040) and 500 ft. reels (Base AMP Part Number 971111)

30 AWG, Other conductor counts available on request. For ordering information, call Toll-Free: **1-877-623-4766** or visit: www.madisoncable.com/fsproducts.htm

.100 [2.54] Centerline, IDC Ribbon Cable, PVC Insulation

Product Specifications

Housing — 300 Volts

UL Recognized — AWM Style 2651

CSA — Available on request

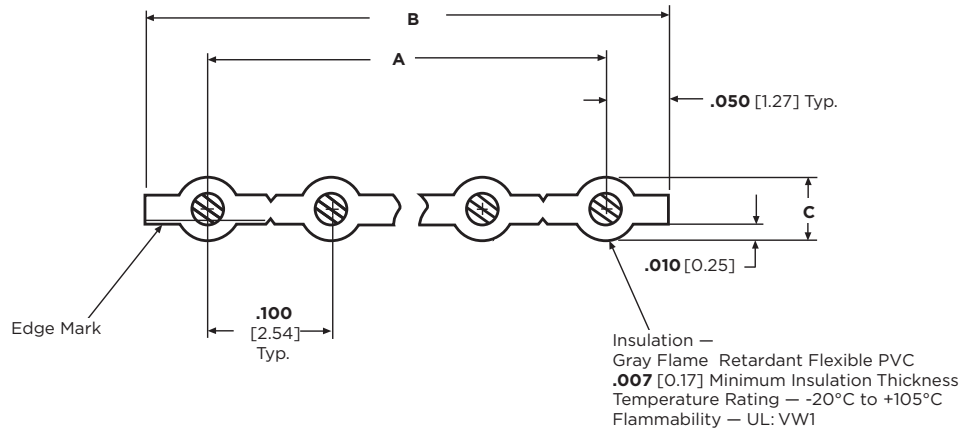

No. of Conductors	Dimensions			Part Number
	A	B	C	
28 AWG 7/32 Tinned Copper				
2	0.100 [2.54]	0.200 [5.08]	0.044 [1.12]	02WFY00006P
5	0.400 [10.16]	0.500 [12.70]	0.044 [1.12]	05WFY00006P
10	0.900 [22.86]	1.000 [25.40]	0.044 [1.12]	10WFY00006P
15	1.400 [35.56]	1.500 [38.10]	0.044 [1.12]	15WFY00006P
20	1.900 [48.26]	2.000 [50.80]	0.044 [1.12]	20WFY00006P
25	2.400 [60.96]	2.500 [63.50]	0.044 [1.12]	25WFY00006P
28	2.700 [68.58]	2.800 [71.12]	0.044 [1.12]	28WFY00006P
26 AWG 7/34 Tinned Copper				
2	0.100 [2.54]	0.200 [6.08]	0.039 [.99]	02WEY00008P
5	0.400 [10.16]	0.500 [12.70]	0.039 [.99]	05WEY00004P
10	0.900 [22.86]	1.000 [25.40]	0.039 [.99]	10WEY00012P
15	1.400 [35.56]	1.500 [38.10]	0.039 [.99]	15WEY00002P
20	1.900 [48.26]	2.000 [50.80]	0.039 [.99]	20WEY00008P
25	2.400 [60.96]	2.500 [63.50]	0.039 [.99]	25WEY00008P
28	2.700 [68.58]	2.800 [71.12]	0.039 [.99]	28WEY00008P
26 AWG 7/34 Overcoated Tinned Copper				
2	0.100 [2.54]	0.200 [5.08]	0.039 [.99]	02WEY00007P
5	0.400 [10.16]	0.500 [12.70]	0.039 [.99]	05WEY00007P
10	0.900 [22.86]	1.000 [25.40]	0.039 [.99]	10WEY00007P
15	1.400 [35.56]	1.500 [38.10]	0.039 [.99]	15WEY00007P
20	1.900 [48.26]	2.000 [50.80]	0.039 [.99]	20WEY00007P
25	2.400 [60.96]	2.500 [63.50]	0.039 [.99]	25WEY00007P
28	2.700 [68.58]	2.800 [71.12]	0.03 [.99]	28WEY00007P

Other Conductor Counts Available on Request.

No. of Conductors	Dimensions			Part Number
	A	B	C	
24 AWG 7/32 Overcoated Tinned Copper				
2	0.100 [2.54]	0.200 [5.08]	0.044 [1.12]	02WFY00007P
5	0.400 [10.16]	0.500 [12.70]	0.044 [1.12]	05WFY00007P
10	0.900 [22.86]	1.000 [25.40]	0.044 [1.12]	10WFY00007P
15	1.400 [35.56]	1.500 [38.10]	0.044 [1.12]	15WFY00007P
20	1.900 [48.26]	2.000 [50.80]	0.044 [1.12]	20WFY00007P
25	2.400 [60.96]	2.500 [63.50]	0.044 [1.12]	25WFY00007P
28	2.700 [68.58]	2.800 [71.12]	0.044 [1.12]	28WFY00007P
22 AWG 7/30 Tinned Copper				
2	0.100 [2.54]	0.200 [5.08]	0.051 [1.30]	02WGY00001P
5	0.400 [10.16]	0.500 [12.70]	0.051 [1.30]	05WGY00006P
10	0.900 [22.86]	1.000 [25.40]	0.051 [1.30]	10WGY00002P
15	1.400 [35.56]	1.500 [38.10]	0.051 [1.30]	15WGY00006P
20	1.900 [48.26]	2.000 [50.80]	0.051 [1.30]	20WGY00006P
25	2.400 [60.96]	2.500 [63.50]	0.051 [1.30]	25WGY00006P
28	2.700 [68.58]	2.800 [71.12]	0.051 [1.30]	28WGY00006P

Contact MADISON CABLE (1-877-MADISON), a division of TE Connectivity, for engineering questions or for order placement of this cable.

.156 [3.96] Centerline, Flat Ribbon Cable, PVC Insulation

Product Specifications

Housing — 300 Volts

UL Recognized — AWM Style 2651

CSA — Available on request



No. of Conductors	Dimensions			Part Number
	A	B	C	
22 AWG 7/30 Tinned Copper				
2	0.156 [3.96]	0.312 [7.92]	0.051 [1.30]	02WGY00008P
5	0.624 [15.85]	0.780 [19.81]	0.051 [1.30]	05WGY00008P
10	1.404 [35.66]	1.560 [39.62]	0.051 [1.30]	10WGY00008P
15	2.184 [55.47]	2.340 [59.44]	0.051 [1.30]	15WGY00008P
20	2.964 [75.29]	3.120 [79.25]	0.051 [1.30]	20WGY00008P
24	3.588 [91.14]	3.744 [95.10]	0.051 [1.30]	24WGY00008P
18 AWG 7/26 Tinned Copper				
2	0.156 [3.96]	0.312 [7.92]	0.068 [1.73]	02WJY000001P
5	0.624 [15.85]	0.780 [19.81]	0.068 [1.73]	05WJY000010P
10	1.404 [35.66]	1.560 [39.62]	0.068 [1.73]	10WJY000010P
15	2.184 [55.47]	2.340 [59.44]	0.068 [1.73]	15WJY000010P
20	2.964 [75.29]	3.120 [79.25]	0.068 [1.73]	20WJY000010P
24	3.588 [91.14]	3.744 [95.10]	0.068 [1.73]	24WJY000010P

Other Conductor Counts Available on Request.

**Contact MADISON CABLE (1-877-MADISON),
a division of TE Connectivity, for engineering
questions or for order placement of this cable.**

Prepared IDC Ribbon Cable



In addition to bulk cable, the US Engineering Cable Assembly Group offers Prepared Cable for the .100 [2.54] and .156 [3.96] centerline cables. This can be in the form of prenotched cable on reels or cut-to-length cable segments.

Prenotched 250 foot reels of cable can be produced with notches at varying increments or repeating all along the cable. The maximum width of these cables is 20 conductor for the .100 [2.54] centerline and 13 conductor for the .156 [3.96] centerline.

Prepared Cable is also available with a Strip and Retain feature allowing the

cable assembly to be soldered directly to the PC Board. This saves space and cost and reduces spare parts inventory. Strip and Retain on both ends is used in family board applications to maintain the electrical connection when the PC Board is separated into smaller boards after soldering. Widths are limited to 20 conductors for the .100 [2.54] centerline and 13 conductors for the .156 [3.96] centerline. However, multiple cables can be placed side-by-side in a single connector. For other styles and configurations contact the product engineer or product manager.



MTA Wire Termination Flowchart



MTA Application Tooling Options

One-At-A-Time Termination Tooling Part Numbers

Note: Max. Insulation Outside Diameter Wire: .060 [1.52] for MTA-100 Connectors/.095 [2.41] for MTA-156 Connectors

MTA Connector Assembly	Interchangeable Head		Interchangeable Head and Loose-Piece Feed Track	Interchangeable Head and Tape Feed Track	Special Applicator	T-Handle Maintenance Tool
	Manual Hand Tool 58074-1 Air Hand Tool 58075-1 Air Bench Mount Tool 58338-1 Electric Bench Machine 931800-1	Part Number				
MTA-100 Connector	Closed End	58246-1 (Standard)*	933567-1	853546-1 & 853542-1 (Base)	466728-1	59803-1
		58246-2 (Ext Wear)				
		58246-3 (Ribbon Cable)				
MTA-156 Connector	Closed End	58247-1 (Standard)**	933568-1	853547-1 & 853542-1 (Base)	466727-1	59804-1
		58247-2 (Ext Wear)				
		58247-3 (Ribbon Cable)				
MTA-156 Card-Edge	Closed End	58442-1	—	—	—	59803-1
		58443-1	—	—	—	59804-1
MTA-156 Quad	Closed End	58638-1	—	—	—	59803-1
		58061-1	—	—	567020-1	59839-1
		58392-1	—	—	—	59804-1

- Notes:**
1. A repair kit consists of a cam, a feed-slide sub-assembly and a locating pawl. Repair kits can be made available for other interchangeable heads. Consult TE.
 2. Standard modular heads 58246-1 and 58247-1 are recommended for low volume use.
 3. Extended wear modular heads 58246-2 and 58247-2 are recommended for high volume use.
 4. T-Handle Maintenance Tools are for maintenance (field) use only. They are not recommended for production.
 5. Some Manual Hand Tool Assemblies are available:
 - a. Order 58579-1, comprised of Head 58246-1 with Manual Hand Tool 58074-1.
 - b. Order 58580-1, comprised of Head 58247-1 with Manual Hand Tool 58074-1.
 - c. Order 58639-1, comprised of Head 58638-1 with Manual Hand Tool 58074-1.

*Repair Kit 856600-1 **Repair Kit 856600-2

MTA-100 and MTA-156 Mass Termination Tooling Part Numbers

Note: Max. Insulation Outside Diameter Wire: .050 [1.27] for MTA-100 Connectors/.070 [1.78] for MTA-156 Connectors

MTA Connector Assembly	Interchangeable Head		Harness Board Holding Fixture			Interchangeable Head and Tape Feed Track		
	Part Number	Used With	Part Number	Applicator Assembly	Tooling Assembly	Part Number	Used With	
MTA-100 Connector	Closed End	—	58242-1	—	Manual Bench Tool 58024-1 and Tooling Assembly 58039-1	854175-1 & 854200-1 (Base)	312522-1	
			58242-3	58575-1				
	Feed Thru	58644-1 (Discrete Wire) ¹ 58644-2 (Notched Cable) ¹	58074-1 (Man Hd TI)	58243-1		—	—	—
				58243-3		58575-1	—	—
	Closed End (Posted)	—	—	58635-1		58575-1	—	—
Feed Thru (Posted)	—	—	58636-1	58575-1	—	—		
MTA-156 Connector	Closed End	—	58244-1	—	Manual Bench Tool 58024-1 and Tooling Assembly 58040-1	854176-1 & 854200-1 (Base)	312522-1	
			58244-3	58576-1				
	Feed Thru	58646-1 (Discrete Wire) ² 58646-2 (Notched Cable) ²	58074-1 (Man Hd TI)	58245-1		—	—	—
				58245-3		58576-1	—	—
	Card Edge	—	—	59848-1		—	—	—
				59848-3		58576-1	—	—
	Closed End (Posted)	—	—	58009-1		—	—	—
58009-2				58576-1	—	—		
Feed Thru (Posted)	—	—	58010-2	58576-1	—	—		
MTA-156 Quad	Closed End	—	58244-1	—	Manual Bench Tool 58024-1 and Tooling Assy 58040-1	—	—	
			58244-3	58576-1				
	Feed Thru	—	—	58245-1		—	58024-1 and Tooling Assy 58040-1	—
58245-3				58576-1	—	—		

¹2- through 12-positions. ²2- through 8-positions.

MTA Application Tooling Options (Continued)

One-At-A-Time Termination Tooling (Typical Tooling Combinations)



Manual Hand Tool with Interchangeable Head



Air Hand Tool with Interchangeable Head



Air Bench Mount Tool with Interchangeable Head and Foot Switch



Electric Bench Machine with Interchangeable Head

Power Units

Manual Hand Tool — Pistol Grip Handle Part No. 58074-1

- Easy to use
- Ratchet control will not release the trigger until it is fully bottomed
- Head may be rotated for user convenience

Air Hand Tool — Pistol Grip Pneumatic Handle Part No. 58075-1

- Light weight
- Operates at air pressure between 40 and 70 psi [2.76 and 4.83 bar]
- Head may be rotated for user convenience

Air Bench Mount Tool — Bench Mount Power Assembly Part No. 58338-1

- May be mounted with interchangeable head pointed up or down
- Operated by a foot switch
- Operates at air pressure between 40 and 70 psi [2.76 and 4.83 bar]

Electric Bench Machine — IDC Power Unit Part No. 931800-1

- All electric: 120 VAC, 60 Hz, 2 A
- Compact, portable and quiet
- Operated by a foot switch



Air Bench Mount Tool with Interchangeable Head and Loose-Piece Feed Track



Electric Bench Machine with Interchangeable Head and Tape Feed Track



AMP-O-LECTRIC Bench Machine with Special Applicator

Interchangeable Heads and Applicators (Refer to page 58 for part numbers.)

Interchangeable Head

- Terminates one unstripped wire per cycle
- Aligns and holds the connector in place for each termination
- Automatically advances the connector after each termination



Interchangeable Head and Loose-Piece Feed Track

- No special setup required
- Connectors are easily loaded into feed track
- Connectors are fed using a simple spring-loaded pusher

T-Handle Maintenance Tool

Interchangeable Head and Tape Feed Track

- No special setup required
- Tape-mounted connectors are transferred from product reel to feed track by simply pulling on the free end of the carrier tape
- Connectors are fed using a simple spring-loaded pusher

Special Applicator

- Connectors are easily hand loaded into feed track
- Automatically advances the connector after each termination
- Cannot be cycled until the connector is properly positioned

MTA Application Tooling Options (Continued)

Mass Termination Tooling (Typical Tooling Combinations)



Manual Bench Tool with Applicator and Holding Fixture



Air Harness Tool with Applicator



Air Bench Machine



2700 lb Air Bench Machine with Ribbon Cable Notcher Assembly

Power Units

Manual Bench Tool — Arbor Frame Assembly Part No. 58024-1

- Applicator and holding fixture can be oriented for closed-end or feed-thru terminations
- Ram height (insertion depth) is easily adjusted
- May be bench mounted

Air Harness Tools — Hand-Held Power Unit with Applicator Part No. 58575-1 (MTA-100) Part No. 58576-1 (MTA-156)

- Applicator can be rotated 360° for orientation with holding fixture
- Insertion depth is easily adjusted
- Operates at air pressure between 75 and 95 psi [5.17 and 6.55 bar]

Air Bench Machine — Pneumatic Unit Part No. 91112-2

- Operated by a foot switch
- Operates at air pressure between 80 and 90 psi [5.52 and 6.21 bar]
- Not recommended for notching cable with more than 14 conductors

2700 lb Air Bench Machine — Part No. 312522-1

- Operated by a foot switch
- Capable of exerting 2,700 lb [12,000 N] of force at minimum 80 psi [5.52 bar] air pressure
- May be bench mounted

Applicators and Notcher Assemblies



Manual Bench Tool with Applicator and Tape Feed Track

Applicator and Holding Fixture

- Wires are laced into plastic combs for mass termination
- Trims excess wire for closed-end terminations
- Holding fixture may be mounted to a harness board

Applicator and Tape Feed Track

- Tape-mounted connectors are transferred from product reel to feed track by simply pulling on the free end of the carrier tape
- Connectors are fed using a simple spring-loaded pusher
- Feed stop easily adjusted for different connector sizes

Ribbon Cable Notcher Assembly

- Notch cable with up to 28 conductors for .100 centerline, and 24 conductors for .156 centerline
- Pressure plate holds cable in position during notching
- Scrap conveniently removed through a chute with a blast of air from a built-in air valve



Ribbon Cable Notcher Assembly

Part Number	Wire Size AWG	Centerline	Used With
854449-2	26-28	.100 2.54	Manual Bench Tool 58024-1
854449-4	22-28	.100 2.54	Air Bench Machine 91112-2
854449-3	18-24	.156 3.96	2700 lb Bench Machine 312522-1 AMP-O-LECTRIC Bench Machine 1-471273-3 (with Conversion Kit 690675-2)

Use Adapter 854468-1 when putting Notcher in the AMP-O-LECTRIC Machine. Use Adapter 854468-2 when putting Notcher in the 2700 lb Air Bench Machine.

MTA Application Tooling Options (Continued)

Technical Documents

The following is a list of technical documents covering the installation, operation, adjustment, maintenance and repair of MTA application tooling.

Instruction Sheets (IS) provide instructions for assembling or applying the product. They are intended for the Manufacturing Assembler or Operator.

Customer Manuals (CM) provide complete, detailed instructions on the installation, operation, adjustment, maintenance and repair of complex tools and application machines.

Applicator Instructions (AI) are similar to instruction sheets (which cover products and tools), and provide instructions for installation, adjustment and maintenance of applicators used in automatic and semiautomatic machines.

Hand Tools, Power Units & Accessories

Manual Arbor Frame Assembly	58024-1	IS408-6923	2700lb Air Bench Machine	312522-1	CM409-5843
Ribbon Cable Applicator, .100	58039-1	IS408-6685	Terminator Assembly, "G" Term	354500-1	CM409-5842
Ribbon Cable Applicator, .156	58040-1	IS408-6701	AMP-O-LECTRIC Bench Machine	1-471273-3	CM409-5128
Manual Hand Tool	58074-1	IS408-6790	Conversion Kit	690675-2	IS408-8022
Air Bench Mount Tool	58338-1	IS408-9393	Base Assembly	853542-1	IS408-9636
Air Hand Tool (MTA-100)	58575-1	IS408-4260	Base	854200-1	IS408-9650
Air Harness Tool (MTA-156)	58576-1	IS408-4260	Adapter (AMP-O-LECTRIC)	854468-1	IS408-9687
T-Handle Maintenance Tool (MTA-100)	59803-1	IS408-7907	Adapter (2700lb Machine)	854468-2	IS408-9687
T-Handle Maintenance Tool (MTA-156)	59804-1	IS408-7907	Repair Kit	856600-1	IS408-9745
Air Arbor Frame Assembly	91112-2	IS408-7763	Repair Kit	856600-2	IS408-9745
			Electric Bench Mount Tool	931800-1	CM409-5744

One-At-A-Time Termination Tooling

Interchangeable Heads

MTA-100		MTA-156	
58246-1	IS408-6929	58247-1	IS408-6930
58246-2	IS408-9379	58247-2	IS408-9380
58246-3	IS408-4147	58247-3	IS408-4146
58442-1	IS408-9603	58443-1	IS408-9607
58638-1	IS408-4358	58061-1	IS408-6794
		58082-1	IS408-6795
		58392-1	IS408-9450

Interchangeable Head & Loose Piece Feed Track

MTA-100		MTA-156	
933567-1	IS 408-9435	933568-1	IS 408-9466

Interchangeable Heads & Tape Feed Track

MTA-100		MTA-156	
853546-1	IS 408-9636	853547-1	IS 408-9637

Special Applicators

MTA-100		MTA-156	
466728-1	AI 408-8054	466727-1	AI 408-8054
		567020-1	AI 408-8069

Mass Termination Tooling

MTA-100		MTA-156		Die Set Assembly	
58242-1	IS408-7994	58009-1	IS408-7995	854175-1	IS408-9667
58242-3	IS408-7994	58009-2	IS408-7995		
58243-1	IS408-7994	58010-2	IS408-7995		
58635-1	IS408-7994	58244-1	IS408-7995	854176-1	IS408-9650
58636-1	IS408-7994	58244-3	IS408-7995		
58644-1	IS408-4406	58245-1	IS408-7995		
58644-2	IS408-4440	58245-3	IS408-7995		
59844-1	IS408-7994	58646-1	IS408-4405		
59845-1	IS408-7994	58646-2	IS408-4439		
59845-3	IS408-7994	59848-1	IS408-7995		
		59848-3	IS408-7995		

Typical Application Rates

Produce 6-in. [15 cm] Long Jumpers, One 4-Position MTA-100 Connector per End, Discrete Wire

Method	Terminations Per Hour
Manual Hand Tool 58074-1 with Interchangeable Head 58246-1	—
Electric Bench Machine 931800-1 with Interchangeable Head 58246-1	900
Electric Bench Machine 931800-1 with Interchangeable Head and Loose-Piece Feed Track 933567-1	1,100
Electric Bench Machine 931800-1 with Interchangeable Head and Tape Feed Track 853546-1 and 853542-1 (Base)	1,250

Apply One 4-Position MTA-100 Feed-Thru Connector per Assembly, Discrete Wire

Method	Terminations Per Hour
Manual Bench Tool 58024-1 with Applicator and Holding Fixture	650

For further information about tooling call Technical Support.

Produce 6-in. [15 cm] Long Jumpers, One 4-Position MTA-100 Connector per End, Ribbon Cable*

Method	Terminations Per Hour
2700 lb Air Bench Machine 312522-1 with Applicator and Tape Feed Track 854175-1 and 854200-1 (Base)	7,500

* Procedure: Mass terminate 12-conductor ribbon cable with three connectors per end. After terminating, separate by tearing the 12-conductor assembly into three 4-conductor assemblies.

Cable Notching

Method	Cable Ends Per Hour
2700 lb Air Bench Machine 312522-1 with Ribbon Cable Notcher Assembly 854449-2 and 854468-2 (Adapter)	1,000

Part Number Index

Note: This index lists all cataloged parts by base no. only. Complete part nos. (with prefixes and/or suffixes) are shown on the page(s) indicated.

Part No.	Page	Part No.	Page	Part No.	Page		
02WEY00007P	61	640389	42	640642	9	641220	31
02WEY00008P	61	640426	30	640643	33	641221	31
02WFY00006P	61	640427	30	640706	48	641222	31
02WFY00007P	61	640428	30	640707	48	641223	31
02WGY00001P	61	640429	30	640708	10	641224	31
02WGY00008P	62	640430	30	640709	10	641225	31
02WJY000001P	62	640431	30	641113	39	641226	31
05WEY00004P	61	640432	30	641119	41	641231	32
05WEY00007P	61	640433	30	641120	41	641232	32
05WFY00006P	61	640434	30	641121	42	641233	32
05WFY00007P	61	640435	30	641122	14	641234	32
05WGY00006P	61	640440	8	641123	14	641235	32
05WGY00008P	62	640441	8	641124	16	641236	32
05WJY000010P	62	640442	8	641125	16	641237	8
10WEY00007P	61	640443	8	641126	17	641238	8
10WEY00012P	61	640445	41	641127	17	641239	8
10WFY00006P	61	640452	14	641143	34	641240	8
10WFY00007P	61	640453	14	641144	34	641241	8
10WGY00002P	61	640454	16	641145	34	641242	8
10WGY00008P	62	640455	16	641146	34	641243	8
10WJY000010P	62	640456	17	641147	34	641244	8
15WEY00002P	61	640457	17	641148	30	641302	32
15WEY00007P	61	640468	8	641149	30	641311	8
15WFY00006P	61	640469	8	641150	30	641312	8
15WFY00007P	61	640470	8	641151	30	641313	8
15WGY00006P	61	640471	8	641152	30	641314	8
15WGY00008P	62	640472	30	641153	30	641425	38
15WJY000010P	62	640473	30	641154	30	641426	38
20WEY00007P	61	640474	30	641155	30	641427	38
20WEY00008P	61	640477	30	641156	30	641428	38
20WFY00006P	61	640480	30	641157	30	641429	38
20WFY00007P	61	640550	9	641168	32	641435	38
20WGY00006P	61	640551	33	641170	32	641436	38
20WGY00008P	62	640556	34	641175	32	641437	38
20WJY000010P	62	640557	34	641186	10	641438	38
24WEY00007P	61	640558	34	641187	10	641439	38
24WEY00008P	61	640559	34	641188	10	641440	38
24WFY00006P	61	640595	32	641189	10	641522	38
24WFY00007P	61	640599	32	641190	8	641523	38
24WGY00006P	61	640600	32	641191	8	641524	38
24WGY00008P	62	640601	32	641192	8	641525	38
24WJY000010P	62	640602	32	641193	8	641526	38
25WEY00007P	61	640604	32	641198	8	641533	35
25WEY00008P	61	640605	32	641199	8	641534	8
25WFY00006P	61	640606	32	641200	8	641535	8
25WFY00007P	61	640607	32	641201	8	641536	8
25WGY00006P	61	640608	32	641202	39	641537	8
28WEY00007P	61	640620	8	641203	39	641550	48
28WEY00008P	61	640621	8	641204	40	641623	35
28WFY00006P	61	640622	8	641207	42	641643	9
28WFY00007P	61	640623	8	641208	41	641644	9
28WGY00006P	61	640629	35	641209	41	641645	9
57034	60	640630	35	641210	42	641646	9
57040	60	640631	34	641211	14	641653	8
350980	48, 49	640632	34	641212	14	641654	8
640250	49	640633	34	641213	16	641655	8
640251	49	640634	34	641214	16	641656	8
640252	48, 49	640635	34	641215	17	641994	10
640383	39	640636	10	641216	17	643067	33
640384	39	640637	10	641217	31	643071	33
640385	40	640638	10	641218	31	643075	9
640387	42	640639	10	641219	31	643077	9
640388	41						

Part Number Index (Continued)

Part No.	Page	Part No.	Page	Part No.	Page	Part No.	Page
643498	8	644615	43	647004	13	647481	38
643813	8	644617	44	647005	13	647485	51
643814	8	644631	43	647006	13	647496	32
643815	8	644633	44	647007	13	647497	38
643816	8	644662	30	647008	13	647609	17
643817	30	644663	30	647009	13	647623	17
643818	30	644687	30	647010	13	647624	17
643819	30	644694	15	647011	13	647625	17
643820	30	644695	15	647012	13	647626	17
643821	30	644702	8	647013	13	647627	17
643828	8	644718	32	647014	13	647628	19
643995	38	644720	32	647015	13	647629	19
644020	8	644726	8	647016	13	647630	19
644038	8	644749	39	647017	13	647646	40
644040	8	644750	39	647018	13	647648	45
644042	8	644751	40	647019	13	647649	45
644043	8	644752	41	647020	13	647651	19
644044	8	644753	41	647021	13	647652	19
644082	30	644754	42	647022	13	647653	19
644083	8	644755	42	647023	13	770258	48
644284	30	644756	39	647030	13	770476	48, 51
644312	8	644759	41	647031	13	770522	48
644313	8	644760	41	647032	13	770849	49
644456	15	644761	42	647033	13	770894	50
644457	15	644763	39	647047	20	971111	53
644460	30	644766	41	647048	20	1375819	24
644461	30	644767	41	647050	21	1375820	24
644462	30	644768	42	647051	21	1445336	24
644463	30	644769	42	647075	20	1744017	41
644464	30	644783	30	647076	20	1744020	8
644465	32	644791	30	647078	21		
644466	32	644795	8	647079	21		
644467	32	644803	23	647106	22		
644468	32	644807	38	647107	22		
644469	32	644809	38	647108	22		
644470	32	644812	38	647109	20		
644471	32	644814	38	647114	20		
644486	23	644860	30	647116	21		
644487	23	644861	23	647117	21		
644488	23	644874	17	647123	46		
644489	23	644875	17	647125	46		
644497	8	644876	16	647127	46		
644501	30	644877	16	647166	22		
644502	30	644878	30	647167	22		
644511	8	644884	15	647168	22		
644512	8	644885	15	647295	21		
644513	8	644886	15	647296	21		
644514	8	644887	15	647297	21		
644540	8	644888	15	647298	20		
644563	8	644889	15	647299	20		
644564	8	644890	15	647300	20		
644565	8	644891	15	647400	51		
644566	30	644892	25	647401	51		
644570	30	644893	25	647402	51		
644574	8	644894	25	647406	51		
644575	8	644896	25	647409	51		
644576	8	644897	25	647466	51		
644577	8	644898	25	647476	38		
644578	8	647000	13	647477	8		
644579	8	647001	13	647478	30		
644611	43	647002	13	647479	32		
644613	44	647003	13	647480	8		

Application Tooling Part Number Index

Part No.	Page	Part No.	Page	Part No.	Page	Part No.	Page
58009	58, 61	58517	24	91112	60, 61	854175	58, 61
58010	58, 61	58575	58, 60, 61	312522	58, 60, 61	854176	58, 61
58024	58, 60, 61	58576	58, 60, 61	354500	61	854200	58, 61
58039	58, 61	58579	58	466468	48	854449	60
58040	58, 61	58614	48	466727	58, 61	854468	60, 61
58061	58, 61	58635	58, 61	466728	58, 61	856600	58, 61
58074	58, 60, 61	58636	58, 61	466747	10	931800	58, 60, 61
58075	58, 59	58638	58, 61	466947	48	933567	58, 61
58082	58, 61	58639	58	471273	60, 61	933568	58, 61
58242	58, 61	58644	58, 61	567020	58, 61	1583503	58, 61
58243	58, 61	58646	58, 61	567373	24	1583514	58, 61
58244	58, 61	59803	58, 61	567827	24	1583515	58, 61
58245	58, 61	59804	58, 61	567828	48	1583516	58, 61
58246	58, 61	59836	10	567910	24	1583517	58, 61
58247	58, 61	59837	34	680211	48	1583518	58, 61
58338	58, 60, 61	59839	58	690675	60, 61		
58392	58, 61	59845	61	853542	58, 61		
58442	58, 61	59848	47, 50	853546	58, 61		
58443	58, 61	90471	48	853547	58, 61		

Global Contacts

Americas

Argentina – Buenos Aires
Phone: +54-11-4733-2200
Fax: +54-11-4733-2211

Brasil – São Paulo
Phone: +55-11-2103-6000
Fax: +55-11-2103-6030

Chile – Santiago
Phone: +56-2-345-0361
Fax: +56-2-223-1477

Canada – Toronto
Phone: +905-475-6222
Fax: +905-474-5520
Product Information Center:
Phone: +905-470-4425
Fax: +905-474-5525

Colombia – Bogota
Phone: +57-1-319-8959
Fax: +57-1-319-8960

Mexico – Mexico City
Phone: +52-55-1106-0800
+01-800-733-8926
Fax: +52-55-1106-0901

For Latin/South American Countries not shown
Phone: +54-11-4733-2015
Fax: +54-11-4733-2083

United States
Harrisburg, PA
Phone: +1-717-564-0100
Fax: +1-717-986-7575
Product Information Center:
Phone: +1-800-522-6752
Fax: +1-717-986-7575
Troy, MI
Phone: +1-248-273-3359
Fax: +1-248-273-3322

Asia/Pacific

Australia – Sydney
Phone: +61-2-9554-2600
Fax: +61-2-9502-2556
Product Information Center:
Phone: +61-2-9840-8200
Fax: +61-2-9634-6188

India – Bangalore
Phone: +91-80-285-40800
Fax: +91-80-285-40820

Indonesia – Jakarta
Phone: +65-6482-0311
Fax: +65-6482-1012

Japan – Kawasaki, Kanagawa
Phone: +81-44-844-8111
Fax: +81-44-812-3207
Product Information Center:
Phone: +81-44-844-8013
Fax: +81-44-812-3200

Korea – Seoul
Phone: +82-2-3415-4500
Fax: +82-2-3486-3810

Malaysia – Selangor
Phone: +60-3-7805-3055
Fax: +60-3-7805-3066

New Zealand – Auckland
Phone: +64-9-634-4580
Fax: +64-9-634-4586

Philippines – Makati City
Phone: +632-848-0171
Fax: +632-867-8661

People's Republic of China
Hong Kong
Phone: +852-2735-1628
Fax: +852-2735-0243

Shanghai
Phone: +86-21-2407-1588
Fax: +86-21-2407-1599

Singapore – Singapore
Phone: +65-6482-0311
Fax: +65-6482-1012

Taiwan – Taipei
Phone: +886-2-8768-2788
Fax: +886-2-8768-2268

Thailand – Bangkok
Phone: +66-2-955-0500
Fax: +66-2-955-0505

Vietnam – Ho Chi Minh City
Phone: +84-8-930-5546
Fax: +84-8-930-3443

Europe/Middle East/Africa

Austria – Vienna
Phone: +43-1-905-60-0
Fax: +43-1-905-60-1333
Product Information Center:
Phone: +43-1-905-60-1249
Fax: +43-1-905-60-1251

Belarus – Minsk
Phone: +375 17 237 47 94
Fax: +375 17 237 47 94

Belgium – Kessel-Lo
Phone: +32-16-352-300
Fax: +32-16-352-355

Bulgaria – Sofia
Phone: +359-2-971-2152
Fax: +359-2-971-2153

Czech Republic and Slovakia
Czech Republic – Kurim
Phone: +420-541-162-111
Fax: +420-541-162-223
Product Information Center:
Phone: +420-541-162-113
Fax: +420-541-162-132

Denmark – Glostrup
Phone: +45-43-48-04-00
Fax: +45-43-44-14-14

Egypt – Cairo
Phone: +202-419-2334
Fax: +202-417-7647

Estonia – Tartu
Phone: +372-5138-274
Fax: +372-7400-779

Finland – Helsinki
Phone: +358-95-12-34-20
Fax: +358-95-12-34-250

France – Cergy-Pontoise Cedex
Phone: +33-1-3420-8888
Fax: +33-1-3420-8600
Product Information Center:
Phone: +33-1-3420-8686
Fax: +33-1-3420-8623

France Export Divisions –
Cergy-Pontoise Cedex
Phone: +33-1-3420-8804
Fax: +33-1-3420-8699

Germany – Bensheim
Phone: +49-6251-133-0
Fax: +49-6251-133-1600
Product Information Center:
Phone: +49-6251-133-1999
Fax: +49-6251-133-1988

Greece – Athens
Phone: +30-210-9370-396/397
Fax: +30-210-9370-655

Hungary – Budapest
Phone: +36-1-289-1000
Fax: +36-1-289-1010
Product Information Center:
Phone: +36-1-289-1016
Fax: +36-1-289-1017

Ireland – Dublin
Phone: +353-1-866-5612
Fax: +353-1-866-5714

Israel – Petach-Tikva
Phone: +972-3-929-0999
Fax: +972-3-919-1088

Italy – Collegno (Torino)
Phone: +39-011-4012-111
Fax: +39-011-4031-116
Product Information Center:
Phone: +39-011-4012-428
Fax: +39-011-40-287-428

Lithuania and Latvia
Lithuania – Vilnius
Phone: +370-5-213-1402
Fax: +370-5-213-1403
Product Information Center:
Phone: +370-5-211-3016
Fax: +370-5-213-1403

Netherlands – 's-Hertogenbosch
Phone: +31-73-6246-246
Fax: +31-73-6212-365
Product Information Center:
Phone: +31-73-6246-999
Fax: +31-73-6246-998

Norway – Nesbru
Phone: +47-66-77-88-50
Fax: +47-66-77-88-55

Poland – Warsaw
Phone: +48-22-4576-700
Fax: +48-22-4576-720
Product Information Center:
Phone: +48-22-4576-704
Fax: +48-22-4576-720

Romania – Bucharest
Phone: +40-21-311-3479/3596
Fax: +40-21-312-0574

Russia – Moscow
Phone: +7-495-790-7902
Fax: +7-495-721-1893
Product Information Center:
Phone: +7-495-790-7902-404
Fax: +7-495-790-7902-401

Russia – St. Petersburg
Phone: +7-812-718-8192
Fax: +7-812-718-8193

Slovenia – Ljubljana
Phone: +386-1561-3270
Fax: +386-1561-3240

South Africa – Port Elizabeth
Phone: +27-41-503-4500
Fax: +27-41-581-0440

Spain – Barcelona
Phone: +34-93-291-0330
Fax: +34-93-201-7879

Sweden – Upplands Väsby
Phone: +46-8-50-72-50-00
Fax: +46-8-50-72-50-01

Switzerland – Steinach
Phone: +41-71-447-0447
Fax: +41-71-447-0444

Turkey – Istanbul
Phone: +90-212-281-8181/2/3
+90-212-282-5130/5430
Fax: +90-212-281-8184

Ukraine – Kiev
Phone: +380-44-206-2265
Fax: +380-44-206-2264
Product Information Center:
Phone: +380-44-206-2265
Fax: +380-44-206-2264

United Kingdom –
Stanmore, Middlesex
Phone: +44-8706-080208
Fax: +44-208-954-6234
Product Information Center:
Freephone (UK only):
+0800-267-666
Phone: +44-8706-080208
Fax: +44-208-420-8095

TE TECHNICAL SUPPORT CENTER

USA:	+1 (800) 522-6752
Canada:	+1 (905) 475-6222
Mexico:	+52 (0) 55-1106-0800
Latin/S. America:	+54 (0) 11-4733-2200
Germany:	+49 (0) 6251-133-1999
UK:	+44 (0) 800-267666
France:	+33 (0) 1-3420-8686
Netherlands:	+31 (0) 73-6246-999
China:	+86 (0) 400-820-6015

te.com

TE Connectivity, TE Connectivity (logo) and Every Connection Counts are trademarks. All other logos, products and/or company names referred to herein might be trademarks of their respective owners.

The information given herein, including drawings, illustrations and schematics which are intended for illustration purposes only, is believed to be reliable. However, TE Connectivity makes no warranties as to its accuracy or completeness and disclaims any liability in connection with its use. TE Connectivity's obligations shall only be as set forth in TE Connectivity's Standard Terms and Conditions of Sale for this product and in no case will TE Connectivity be liable for any incidental, indirect or consequential damages arising out of the sale, resale, use or misuse of the product. Users of TE Connectivity products should make their own evaluation to determine the suitability of each such product for the specific application.

© 2018 TE Connectivity Ltd. family of companies All Rights Reserved.

82056 02/18 Revised

X-ON Electronics

Largest Supplier of Electrical and Electronic Components

Click to view similar products for [Headers & Wire Housings](#) category:

Click to view products by [TE Connectivity](#) manufacturer:

Other Similar products are found below :

[95000-104TRLF](#) [10135584-644402LF](#) [DF62W-EP2022PCA](#) [95000-106TRLF](#) [DF62W-2022SCA](#) [DF62W-EP2022PC](#) [2203348](#) [DF62W-2022SC](#) [1084018](#) [1029039](#) [1084017](#) [802-10-012-10-002000](#) [1112640](#) [1112639](#) [000-34000](#) [0009482033](#) [0009507031](#) [57102-S06-03LF](#) [57202-S52-04LF](#) [PCN6-15S-2.5E](#) [0039019024](#) [58102-G61-06LF](#) [582553-1](#) [0009485154](#) [0009508121](#) [0022285053](#) [0050291907](#) [018731A](#) [LY20-4P-DT1-P1E-BR](#) [02.125.8002.8](#) [60101931](#) [60598-1 \(Cut Strip\)](#) [M1625-3R/100](#) [61062-3](#) [61082-181009](#) [636-1427](#) [638009-1](#) [641938-9](#) [641991-4](#) [644168-1](#) [647662-1](#) [65039-019ELF](#) [65817-002LF](#) [65817-015LF](#) [65863-015LF](#) [66207-023LF](#) [67016-026LF](#) [67046-001LF](#) [67095-007LF](#) [67230-005LF](#)