





SMT Power Inductor

Shielded Drum Core - PA4334.XXXNLT Series



-  **Height:** 1.2mm Max
-  **Footprint:** 3.2mm x 3.2mm Max
-  **Current Rating:** up to 3.0A
-  **Inductance Range:** 0.22uH to 100uH
-  Shielded magnetic circuit reduces leakage flux, Fe base metal core enables high saturation and metalized core termination results in excellent shock resistance.

Electrical Specifications @ 25°C - Operating Temperature -40°C to +125°C

| Part Number | Inductance 1MHz, 1V uH | Rated Current A | Min. Self-Resonant Frequency MHz | DC Resistance | | Saturation Current (20°C) A | Heating Current A |
|---------------|----------------------------------|------------------------|---|---------------|------|---------------------------------------|--------------------------|
| | | | | MAX. | TYP. | | |
| | | | | mΩ | mΩ | | Δ T ≈ 40°C |
| PA4334.221NLT | 0.22 ± 30% | 3.00 | 328 | 22 | 17 | 5.30 | 3.00 |
| PA4334.821NLT | 0.82 ± 30% | 2.05 | 107 | 39 | 30 | 2.05 | 2.47 |
| PA4334.102NLT | 1.0 ± 30% | 1.87 | 89 | 52 | 40 | 1.87 | 2.20 |
| PA4334.122NLT | 1.2 ± 30% | 2.01 | 83 | 59 | 45 | 2.22 | 2.01 |
| PA4334.152NLT | 1.5 ± 30% | 1.62 | 71 | 59 | 45 | 1.62 | 2.01 |
| PA4334.182NLT | 1.8 ± 30% | 1.30 | 65 | 82 | 63 | 1.30 | 1.65 |
| PA4334.222NLT | 2.2 ± 30% | 1.20 | 55 | 98 | 75 | 1.20 | 1.55 |
| PA4334.242NLT | 2.4 ± 30% | 1.15 | 47 | 88 | 68 | 1.15 | 1.60 |
| PA4334.272NLT | 2.7 ± 20% | 1.14 | 54 | 110 | 85 | 1.14 | 1.48 |
| PA4334.332NLT | 3.3 ± 20% | 1.05 | 46 | 130 | 100 | 1.05 | 1.36 |
| PA4334.362NLT | 3.6 ± 20% | 1.05 | 36 | 130 | 100 | 1.05 | 1.36 |
| PA4334.392NLT | 3.9 ± 20% | 1.00 | 53 | 189 | 145 | 1.00 | 1.24 |
| PA4334.472NLT | 4.7 ± 20% | 0.90 | 31 | 156 | 120 | 0.90 | 1.24 |
| PA4334.682NLT | 6.8 ± 20% | 0.75 | 30 | 247 | 190 | 0.75 | 0.98 |
| PA4334.103NLT | 10 ± 20% | 0.60 | 23 | 345 | 265 | 0.60 | 0.83 |
| PA4334.123NLT | 12 ± 20% | 0.48 | 20 | 449 | 345 | 0.48 | 0.73 |
| PA4334.153NLT | 15 ± 20% | 0.45 | 22 | 468 | 360 | 0.45 | 0.71 |
| PA4334.183NLT | 18 ± 20% | 0.43 | 16 | 709 | 545 | 0.43 | 0.58 |
| PA4334.223NLT | 22 ± 20% | 0.42 | 22 | 839 | 645 | 0.42 | 0.53 |
| PA4334.273NLT | 27 ± 20% | 0.35 | 12 | 1131 | 870 | 0.35 | 0.47 |

USA 858 674 8100

Germany 49 2354 777 100

Singapore 65 6287 8998

Shanghai 86 21 62787060

China 86 755 33966678

Taiwan 886 3 4356768

SMT Power Inductor

Shielded Drum Core - PA4334.XXXNLT Series



Electrical Specifications @ 25°C - Operating Temperature -40°C to +125°C

| Part Number | Inductance 1MHz, 1V uH | Rated Current A | Min. Self-Resonant Frequency MHz | DC Resistance | | Saturation Current (20°C) A | Heating Current $\Delta T \approx 40^\circ C$ A |
|---------------|----------------------------------|------------------------|---|---------------|------|---------------------------------------|---|
| | | | | MAX. | TYP. | | |
| | | | | mΩ | mΩ | | |
| PA4334.333NLT | 33 ± 20% | 0.36 | 12 | 1138 | 875 | 0.36 | 0.46 |
| PA4334.363NLT | 36 ± 20% | 0.34 | 10 | 1235 | 950 | 0.34 | 0.44 |
| PA4334.393NLT | 39 ± 20% | 0.37 | 10 | 1729 | 1330 | 0.30 | 0.37 |
| PA4334.473NLT | 47 ± 20% | 0.27 | 11 | 1885 | 1450 | 0.27 | 0.35 |
| PA4334.563NLT | 56 ± 20% | 0.26 | 9 | 1794 | 1380 | 0.26 | 0.28 |
| PA4334.683NLT | 68 ± 20% | 0.24 | 7 | 2171 | 1670 | 0.24 | 0.33 |
| PA4334.823NLT | 82 ± 20% | 0.17 | 7 | 3302 | 2540 | 0.17 | 0.27 |
| PA4334.104NLT | 100 ± 20% | 0.21 | 5 | 3718 | 2860 | 0.21 | 0.25 |

Notes:

- Actual temperature of the component during system operation (ambient plus temperature rise) must be within the standard operating range.
- The rated current as listed is either the saturation current (@ 20°C) or the heating current ($\Delta T \approx 40^\circ C$) depending on which value is lower.
- The saturation current is the current at which the initial inductance drops approximately 30% at the stated ambient temperature. This current is determined by placing the component in the specified ambient environment and applying a short duration pulse current (to eliminate self-heating effect) to the component.
- The heating current is the DC current required to raise the component temperature by approximately 40°C. Take note that the components' performance varies depending on the system condition. It is suggested that the component be tested at the system level, to verify the temperature rise of the component during system operation.
- Maximum voltage across terminals to be limited to <40Vdc

Mechanical

PA4334.XXXNLT

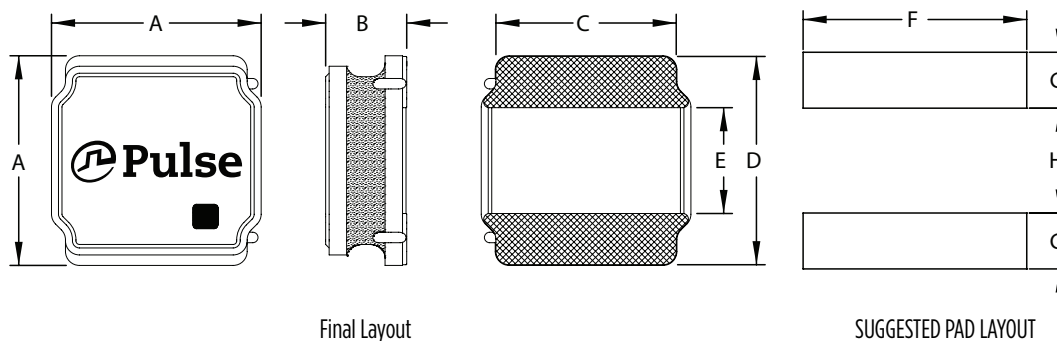

| Series | A | B | C | D | E | F | G | H |
|---------------|---------|---------|-------|-------|-------|-------|-------|-------|
| PA4334.XXXNLT | 3.2 MAX | 1.2 MAX | (2.5) | (3.0) | (1.5) | (2.7) | (0.8) | (1.5) |

All Dimensions in mm.

SMT Power Inductor

Shielded Drum Core - PA4334.XXXNLT Series

TAPE & REEL INFO

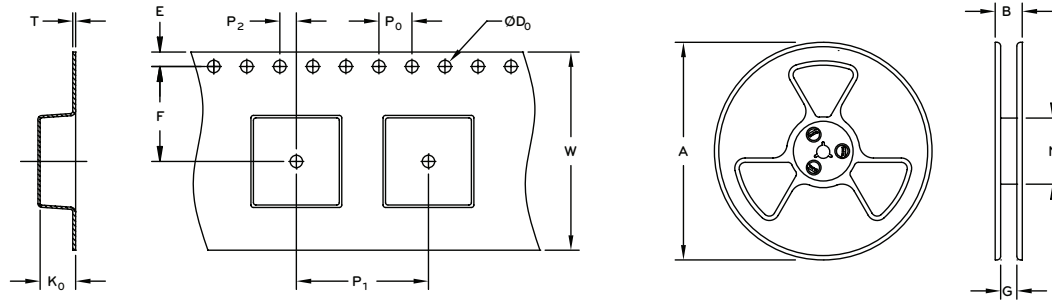

SURFACE MOUNTING TYPE, REEL/TAPE LIST

| | REEL SIZE (mm) | | | | TAPE SIZE (mm) | | | | | | | | | QTY |
|---------------|----------------|------|-----|----|----------------|-----|----------------|----------------|----------------|----------------|---|------|----------------|----------|
| | A | B | G | N | E | F | D ₀ | P ₁ | P ₀ | P ₂ | W | T | K ₀ | PCS/REEL |
| PA4334.XXXNLT | Ø178 | 14.4 | 8.4 | 58 | 1.75 | 3.5 | 1.5 | 4 | 4 | 2 | 8 | 0.25 | 1.6 | 2000 |

Typical Performance Curves

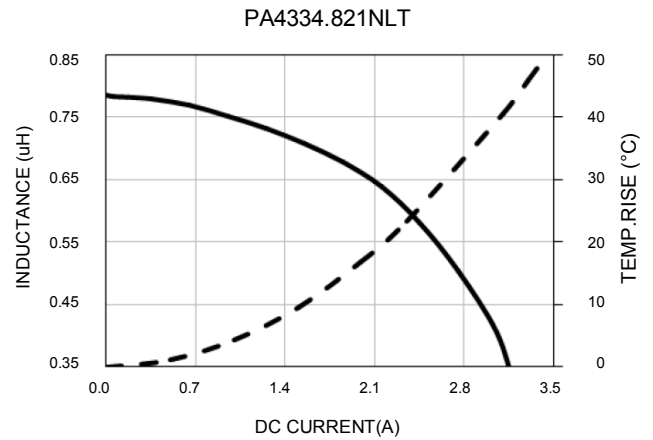
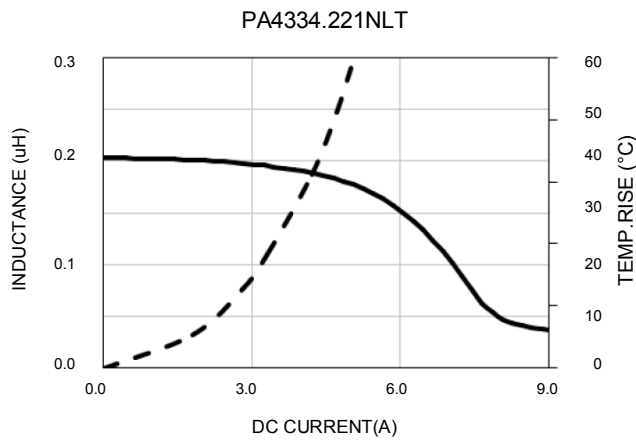

SMT Power Inductor

Shielded Drum Core - PA4334.XXXNLT Series

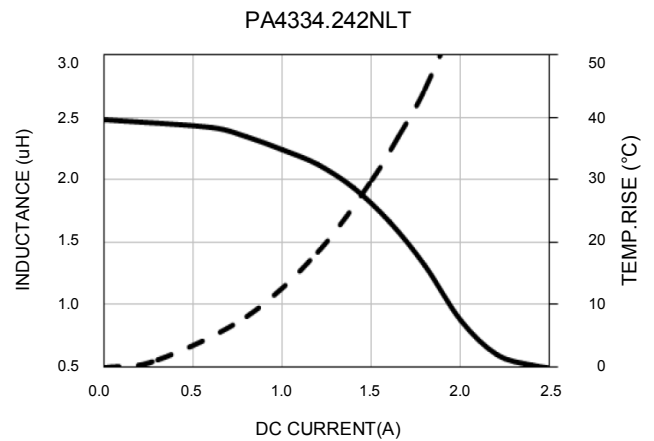
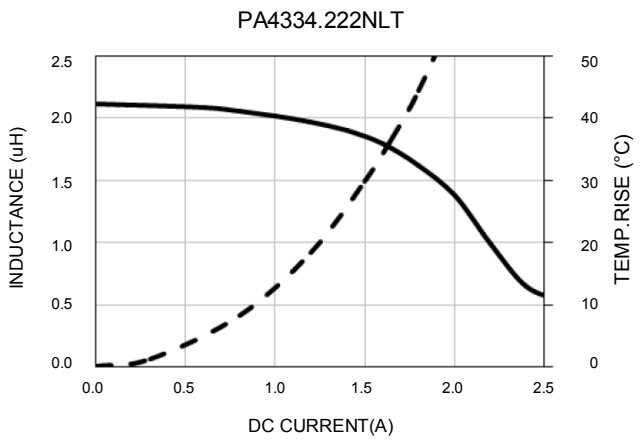
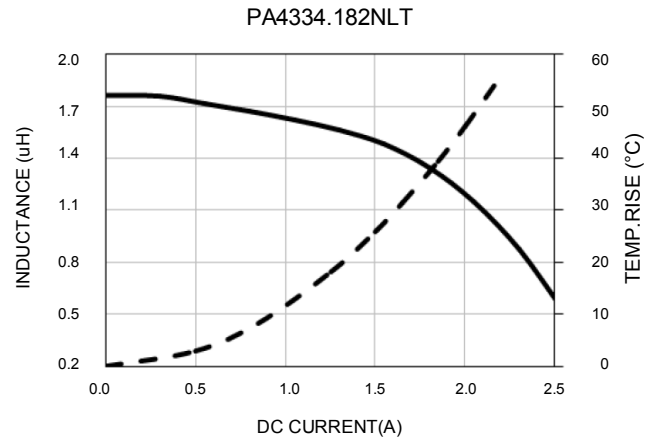
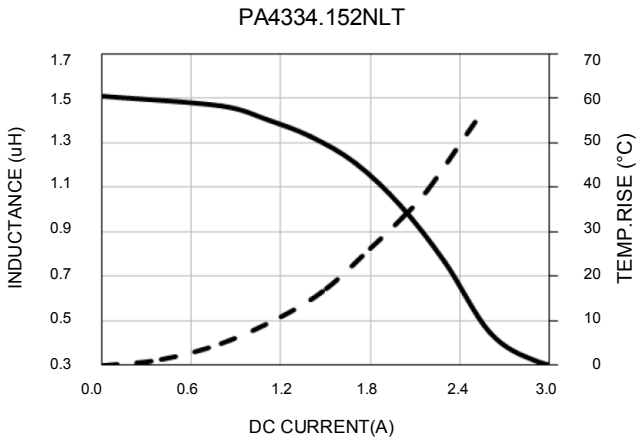
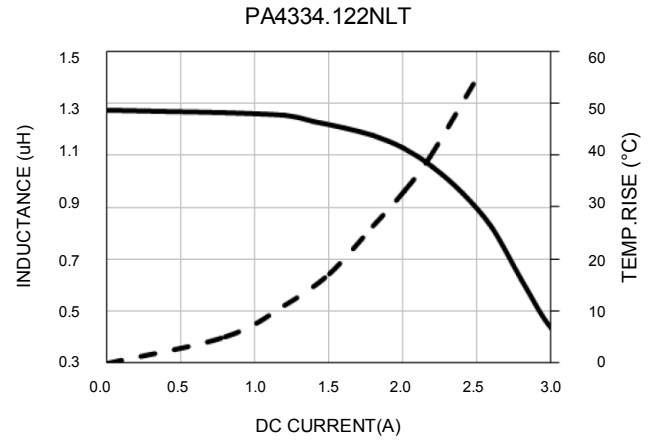
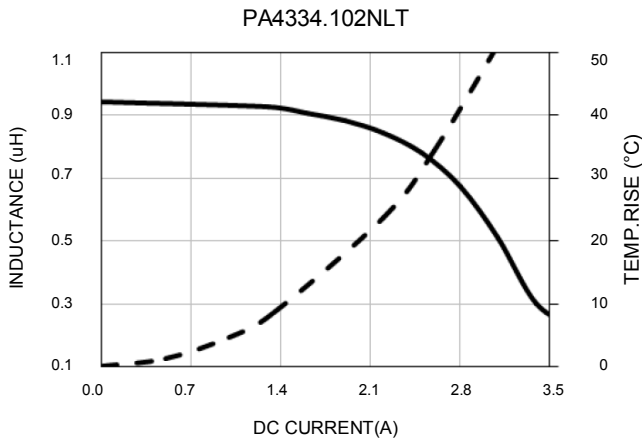

SMT Power Inductor

Shielded Drum Core - PA4334.XXXNLT Series

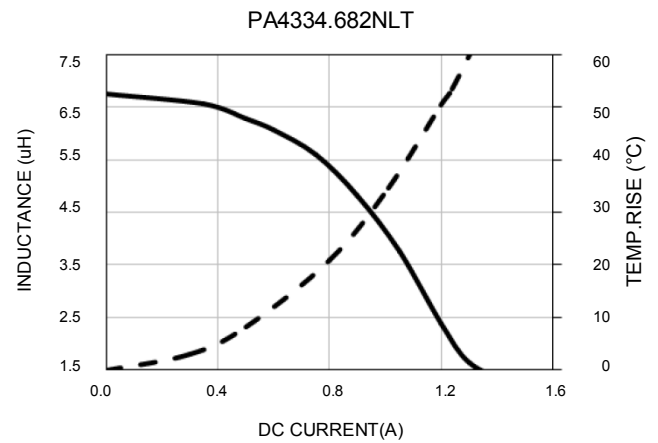
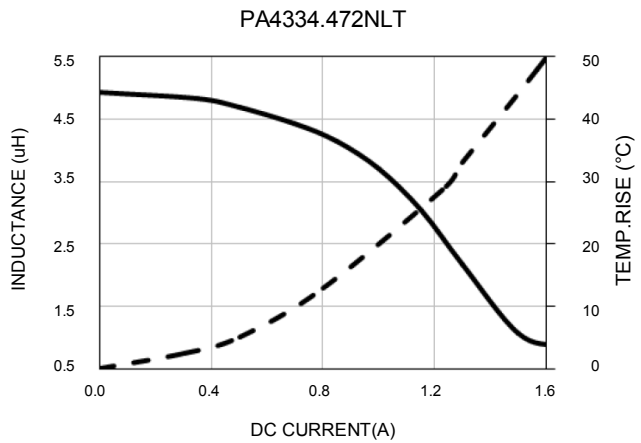
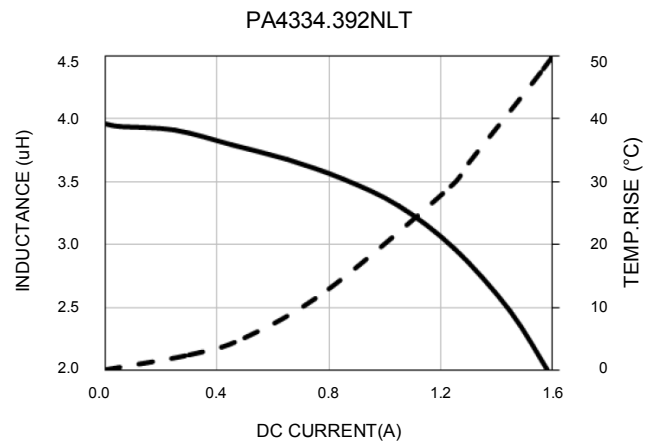
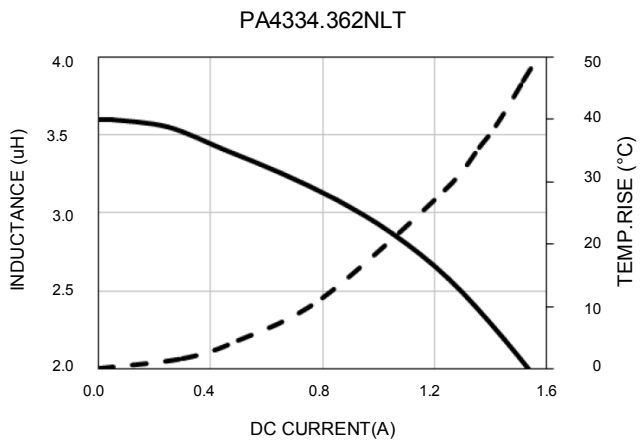
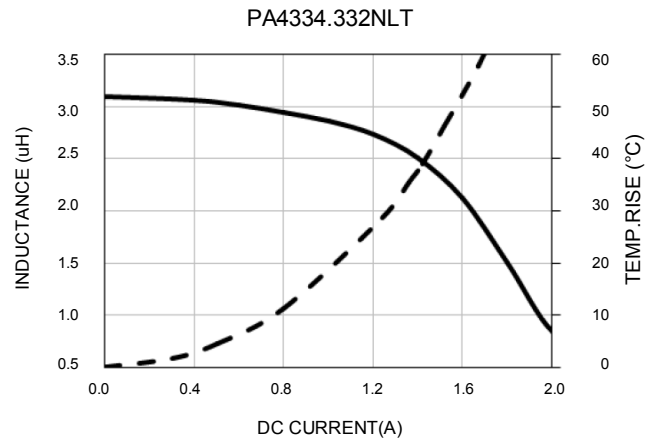
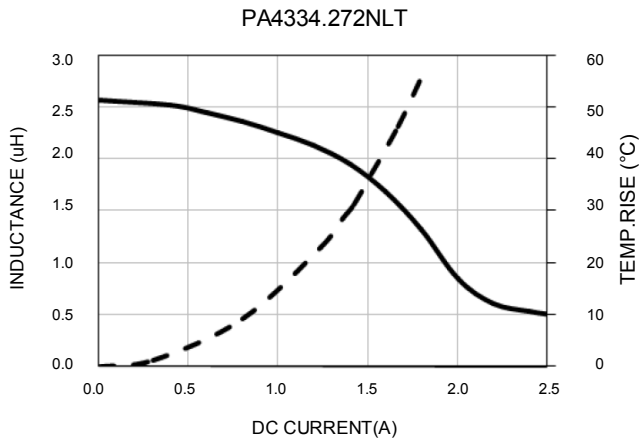

SMT Power Inductor

Shielded Drum Core - PA4334.XXXNLT Series

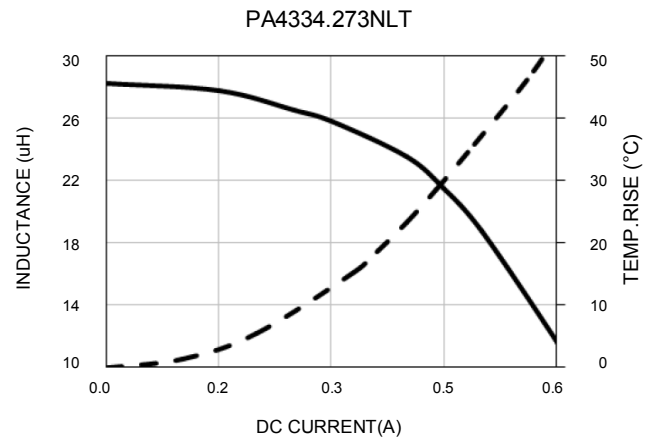
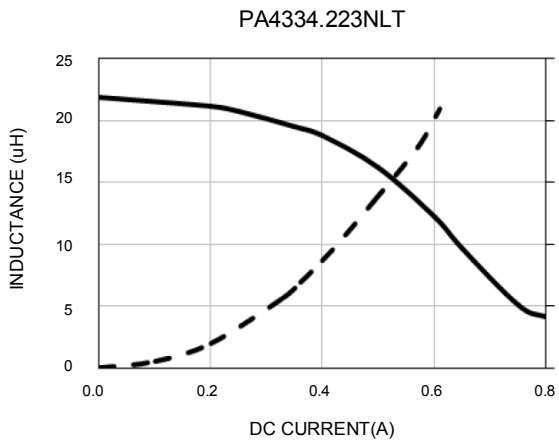
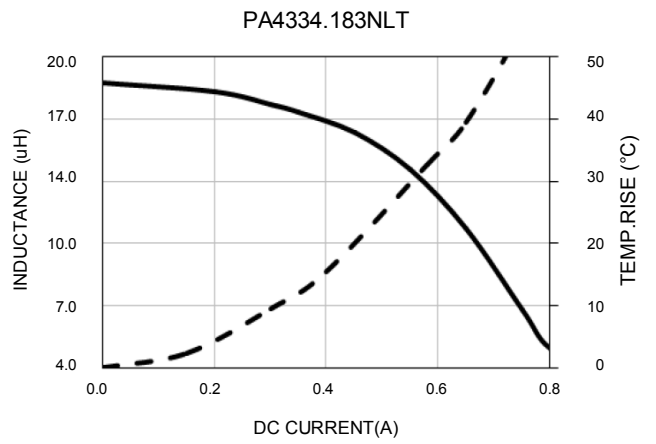
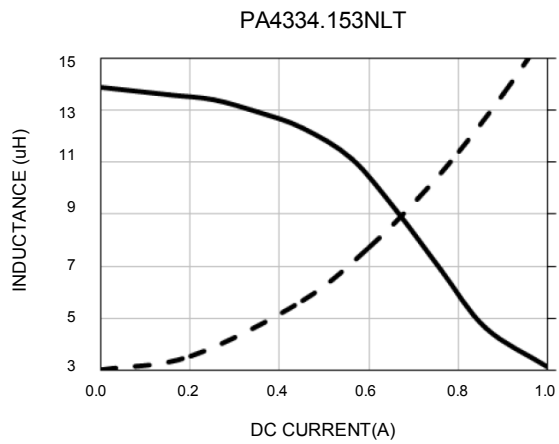
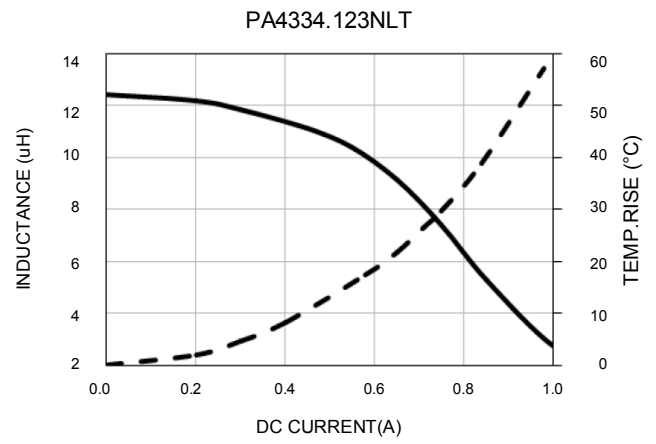
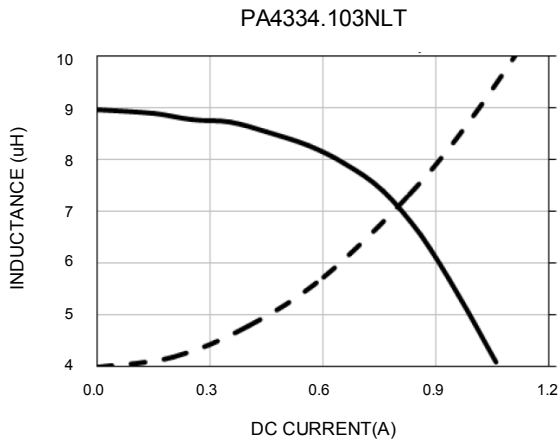

SMT Power Inductor

Shielded Drum Core - PA4334.XXXNLT Series

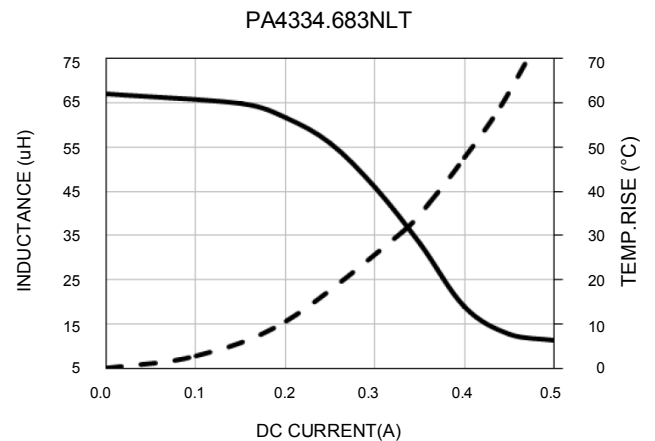
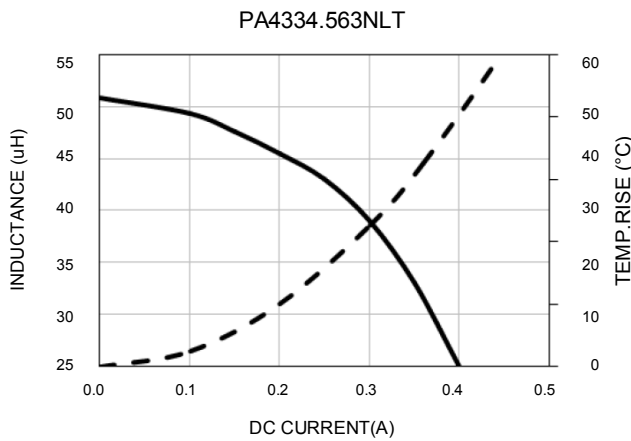
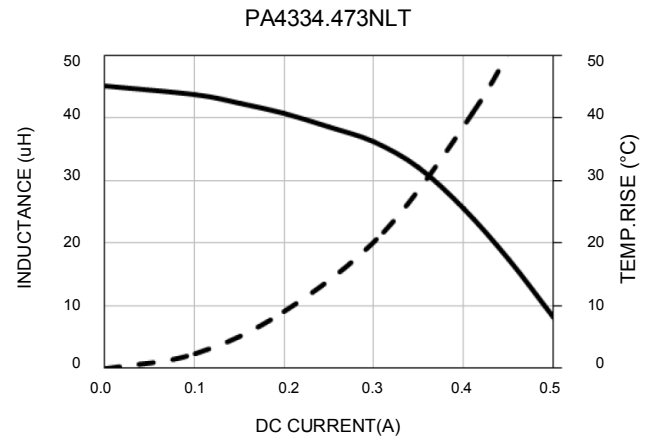
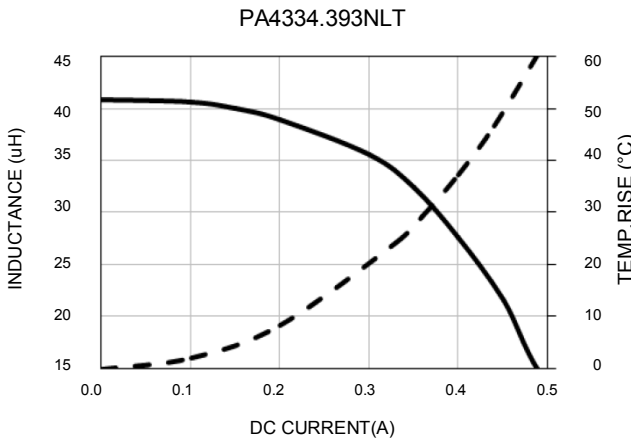
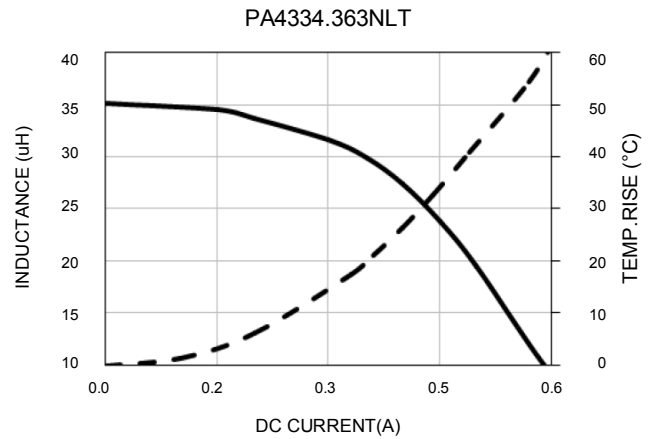
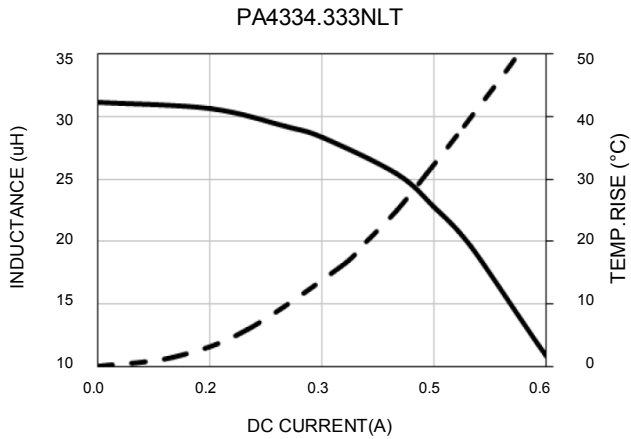

SMT Power Inductor

Shielded Drum Core - PA4334.XXXNLT Series

PA4334.823NLT

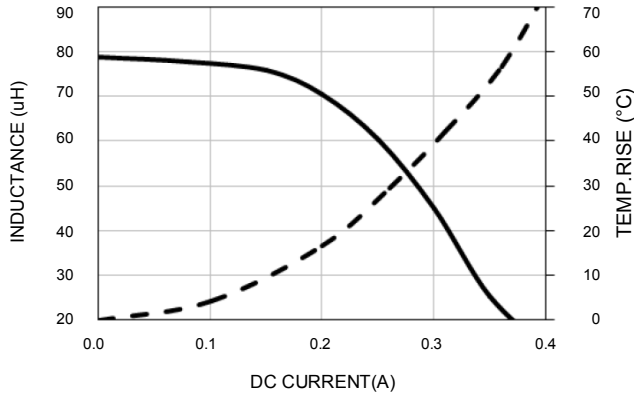

PA4334.104NLT

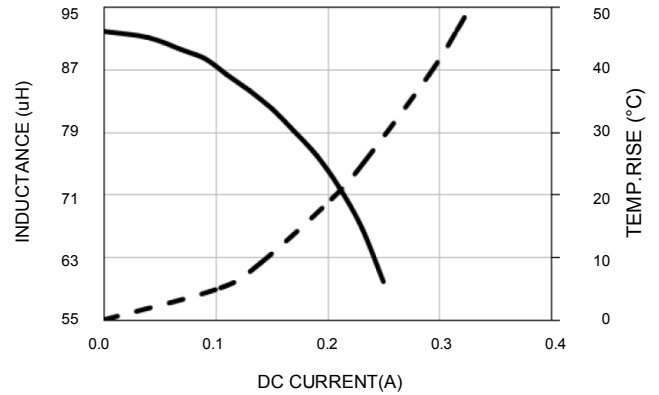

For More Information

Pulse Worldwide Headquarters

12220 World Trade Drive
San Diego, CA 92128
U.S.A.

Tel: 858 674 8100
Fax: 858 674 8262

Pulse Europe

Pulse Electronics GmbH
Am Rottland 12
58540 Meinerzhagen
Germany

Tel: 49 2354 777 100
Fax: 49 2354 777 168

Pulse China Headquarters

B402, Shenzhen Academy of
Aerospace Technology Bldg.
10th Kejinan Road
High-Tech Zone
Nanshan District
Shenzhen, PR China 518057

Tel: 86 755 33966678
Fax: 86 755 33966700

Pulse North China

Room 2704/2705
Super Ocean Finance Ctr.
2067 Yan An Road West
Shanghai 200336
China

Tel: 86 21 62787060
Fax: 86 2162786973

Pulse South Asia

135 Joo Seng Road
#03-02
PM Industrial Bldg.
Singapore 368363

Tel: 65 6287 8998
Fax: 65 6287 8998

Pulse North Asia

3F, No. 198
Zhongyuan Road
Zhongli City
Taoyuan County 320
Taiwan R. O. C.

Tel: 886 3 4356768
Fax: 886 3 4356823 (Pulse)
Fax: 886 3 4356820 (FRE)

Performance warranty of products offered on this data sheet is limited to the parameters specified. Data is subject to change without notice. Other brand and product names mentioned herein may be trademarks or registered trademarks of their respective owners. © Copyright, 2016. Pulse Electronics, Inc. All rights reserved.

X-ON Electronics

Largest Supplier of Electrical and Electronic Components

Click to view similar products for [Fixed Inductors](#) category:

Click to view products by [Pulse manufacturer](#):

Other Similar products are found below :

[MLZ1608M6R8WTD25](#) [MLZ1608N6R8LT000](#) [MLZ1608N3R3LTD25](#) [MLZ1608N3R3LT000](#) [MLZ1608N150LT000](#)

[MLZ1608M150WTD25](#) [MLZ1608M3R3WTD25](#) [MLZ1608M3R3WT000](#) [MLZ1608M150WT000](#) [MLZ1608A1R5WT000](#)

[MLZ1608N1R5LT000](#) [B82432C1333K000](#) [PCMB053T-1R0MS](#) [PCMB053T-1R5MS](#) [PCMB104T-1R5MS](#) [CR32NP-100KC](#) [CR32NP-](#)

[151KC](#) [CR32NP-180KC](#) [CR32NP-181KC](#) [CR32NP-1R5MC](#) [CR32NP-390KC](#) [CR32NP-3R9MC](#) [CR32NP-680KC](#) [CR32NP-820KC](#)

[CR32NP-8R2MC](#) [CR43NP-390KC](#) [CR43NP-560KC](#) [CR43NP-680KC](#) [CR54NP-181KC](#) [CR54NP-470LC](#) [CR54NP-820KC](#) [CR54NP-8R5MC](#)

[MGDQ4-00004-P](#) [MGDU1-00016-P](#) [MHL1ECTTP18NJ](#) [MHL1JCTTD12NJ](#) [PE-51506NL](#) [PE-53601NL](#) [PE-53630NL](#) [PE-53824SNLT](#) [PE-](#)

[62892NL](#) [PE-92100NL](#) [PG0434.801NLT](#) [PG0936.113NLT](#) [PM06-2N7](#) [PM06-39NJ](#) [HC2LP-R47-R](#) [HC2-R47-R](#) [HC3-2R2-R](#) [HC8-1R2-R](#)