

**DIMENSIONS: mm.**

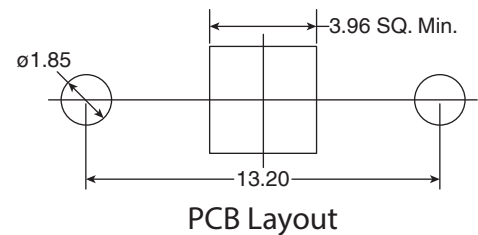
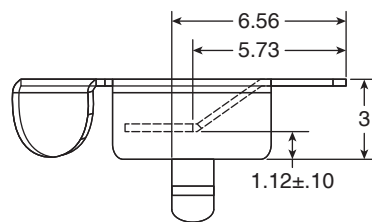
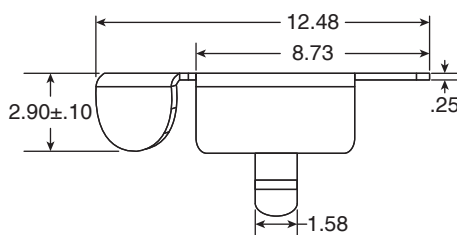
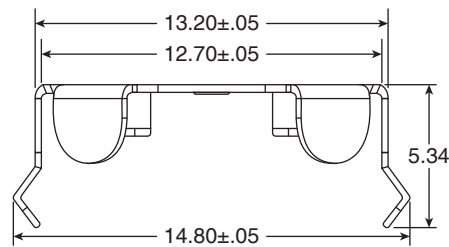
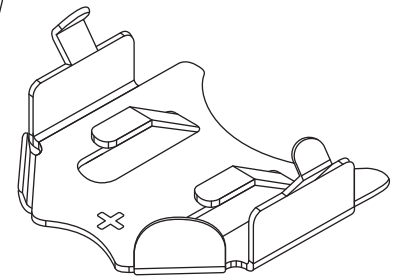
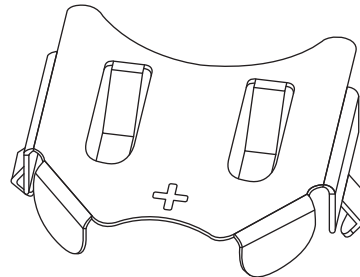
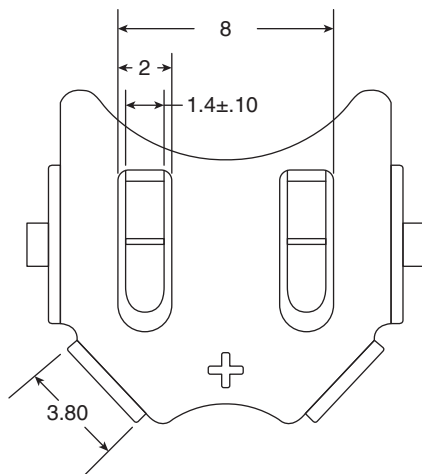

## SPECIFICATIONS

<b>Material:</b>	.25mm Phosphor Bronze Nickel Plated
<b>Battery Size:</b>	CR1216, CR1220, and CR1225
RoHS Compliant	

# X-ON Electronics

Authorized Distributor

*Click to view similar products for Cylindrical Battery Contacts, Clips, Holders & Springs category:*

[1185](#) [1076](#) [1129](#) [FLUKE 707](#) [1101](#) [5230](#) [1198](#) [1014](#) [163-165](#) [MM2030](#)