

PRODUCT NUMBER
10135177-XXXXXLF

- NOTE:
- MATERIAL SPECIFICATION:
 - INSULATION: HIGH TEMP. THERMOPLASTIC, UL 94V-0.
 - CONTACT: COPPER ALLOY
 - NAIL: COPPER ALLOY
 - FINISH SPECIFICATION:
 - CONTACT: Ni UNDERPLATE. SEE P/N FOR PLATING ON CONTACT AREA AND TAILS.
 - NAIL: TIN PLATE OVER Ni UNDERPLATE.
 - RoHS & HF COMPLIANCE
 - PART NO SCHEME:
10135177- XX X X X LF

No. OF POS.: 02~15

HSG COLOR: 1: NATURAL

PLATING: 1: TIN

PACKAGE: 1: TAPE AND REEL

- THE CONNECTOR MATES WITH FCI WIRE CONNECTOR, HSG 10135175 AND CRIMPED TERMINAL 10135176
- THE HOUSING WILL WITHSTAND EXPOSURE TO 260°C PEAK TEMPERATURE 10 SEC. IN A CONVECTION REFLOW OVEN.
- PRODUCT SPECIFICATION: GS-12-1321
- PACKAGE SPECIFICATION: GS-14-2471
- DIMENSIONAL TABLE:

Pos.	A	B	C	D
02	7.30	—	6.10	5.5
03	8.80	3.00	7.60	7.0
04	10.30	4.50	9.10	8.5
05	11.80	6.00	10.60	10.0
06	13.30	7.50	12.10	11.5
07	14.80	9.00	5.00	13.0
08	16.30	10.50	5.00	14.5
09	17.80	12.00	5.00	16.0
10	19.30	13.50	5.00	17.5
11	20.80	15.00	5.00	19.0
12	22.30	16.50	5.00	20.5
13	23.80	18.00	5.00	22.0
14	25.30	19.50	5.00	23.5
15	26.80	21.00	5.00	25.0

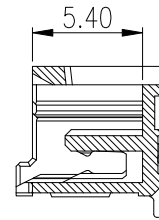
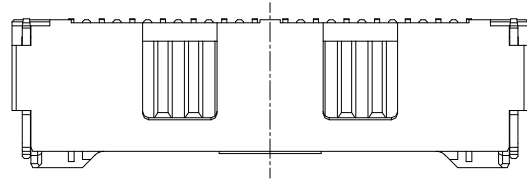

SECTION A-A

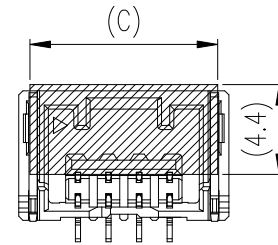
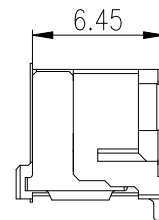

MYLAR FIGURE OF 2P~6P CIRCUIT

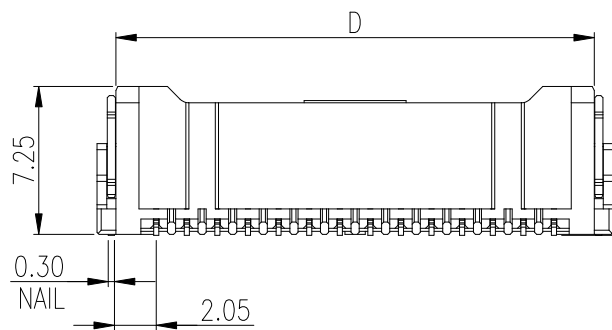
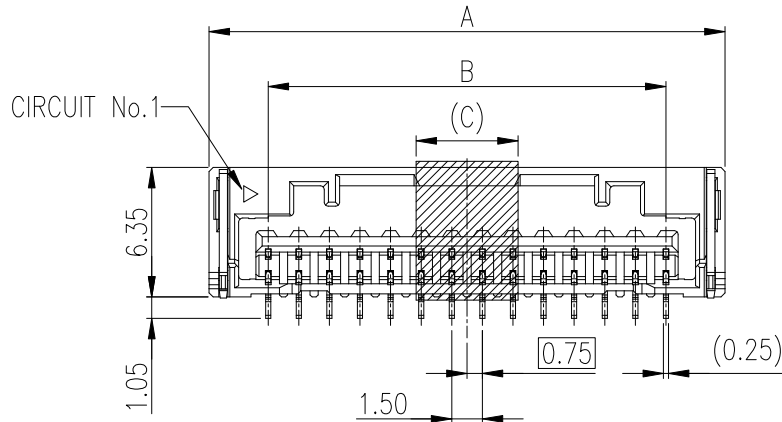

0.10
CONTACT & NAIL

mat'l. code		surface		tolerance	projection	product family	
ltr		ecn no	dr	date	tolerances unless otherwise specified		MINITEK 1.5mm WTB
A			TAI	2015-06-16	angles	X.X±0.3	title
					±2'	X.XX±0.20	MINITEK 1.5mm, RECEPTACLE
					linear	X.XXX±0.100	CONNECTOR, VERTICAL MOUNT, SMT
					dr	KENNY TAI	2015-05-08
					enr	KENNY TAI	2015-05-08
					chr	KENNY TAI	2015-06-10
					appd	PM ZHENG	2015-06-16
sheet index	revision sheet	A	A	1	2	scale	
						FCI	
						dwg no	
						10135177	
						sheet 1 of 2	
						size	
						A4	
						type	
						CUSTOMER Drawing	

PRODUCT NUMBER
10135177-XXXXXL

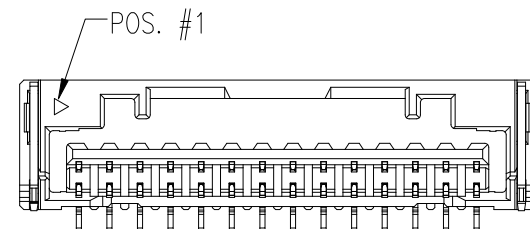
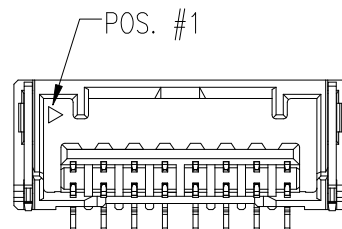
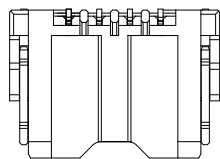
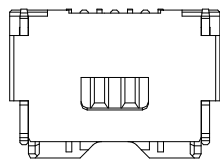
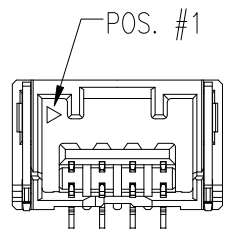

CASE OF 2~5 POSITIONS

CASE OF 2~5 POSITIONS

CASE OF 6~11 POSITIONS

CASE OF 12~15 POSITIONS

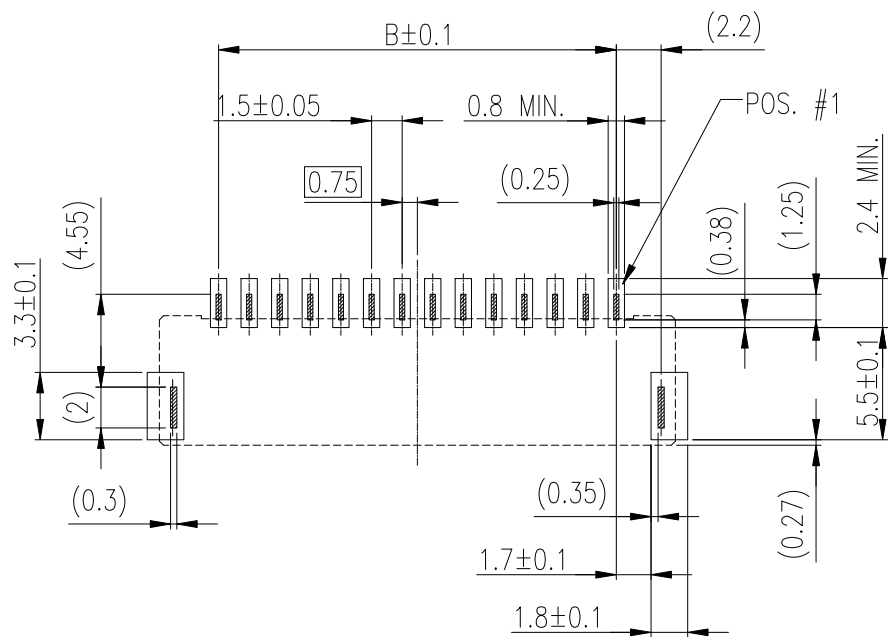

RECOMMENDED P.C.B BOARD LAYOUT
GENERAL TOLERANCE ±0.05

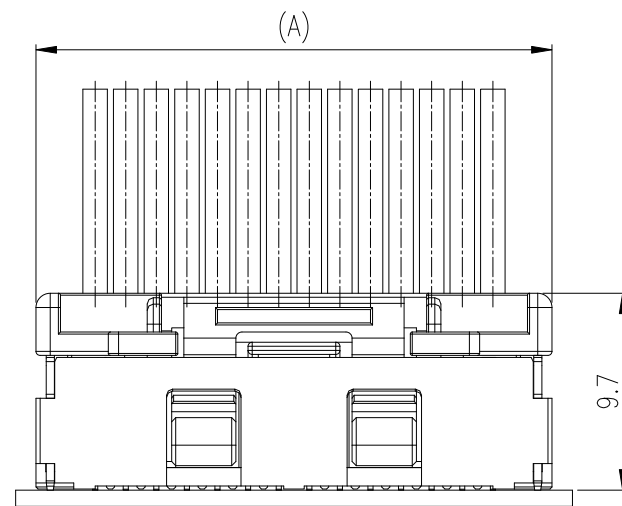
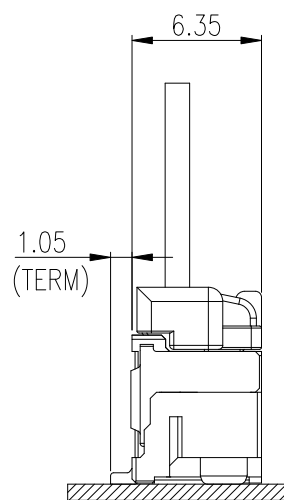

MATED CONNECTORS

mat'l. code				surface		tolerance	projection	product family	
ltr				ecn no		dr		date	
tolerances unless otherwise specified				linear		mm		title	
angles				±2'		scale		MINITEK 1.5mm, RECEPTACLE CONNECTOR, VERTICAL MOUNT, SMT	
dr				KENNY TAI		2015-05-08		sheet 2 of 2	
enr				KENNY TAI		2015-05-08		size	
chr				KENNY TAI		2015-06-10		A4	
appd				PM ZHENG		2015-06-16		type	
sheet index				revision sheet		A 1		CUSTOMER Drawing	
				A 2					

X-ON Electronics

Largest Supplier of Electrical and Electronic Components

Click to view similar products for [Headers & Wire Housings](#) category:

Click to view products by [Amphenol](#) manufacturer:

Other Similar products are found below :

[95000-104TRLF](#) [10135584-644402LF](#) [DF62W-EP2022PCA](#) [95000-106TRLF](#) [DF62W-2022SCA](#) [DF62W-EP2022PC](#) [2203348](#) [DF62W-2022SC](#) [1084018](#) [1029039](#) [1084017](#) [802-10-012-10-002000](#) [1112640](#) [1112639](#) [891-007-9SS-BST1T](#) [000-34000](#) [0008550134](#) [0009482033](#) [0009507031](#) [57102-F02-18ULF](#) [57102-S06-03LF](#) [57202-S52-04LF](#) [PCN6-15S-2.5E](#) [0039019024](#) [58102-G61-06LF](#) [582553-1](#) [0009485154](#) [0009508121](#) [009176003701906](#) [0022285053](#) [0050291907](#) [018731A](#) [LY20-4P-DT1-P1E-BR](#) [02.125.8002.8](#) [60101931](#) [60598-1 \(Cut Strip\)](#) [M1625-3R/100](#) [61062-3](#) [61082-181009](#) [CSU011177004](#) [636-1427](#) [638009-1](#) [641938-9](#) [641991-4](#) [644168-1](#) [644827-2](#) [647662-1](#) [65039-019ELF](#) [65692-001LF](#) [65781-018](#)