

Product Summary

BV_{DSS}	$R_{DS(on) \max}$	I_D $T_C = +25^\circ C$
700V	1.3Ω @ $V_{GS} = 10V$	4.6A

Features and Benefits

- Low On-Resistance
- High BV_{DSS} rating for power application
- Low Input Capacitance
- **Lead-Free Finish; RoHS Compliant (Notes 1 & 2)**
- **Halogen and Antimony Free. "Green" Device (Note 3)**

Description and Applications

This MOSFET is designed to minimize the on-state resistance ($R_{DS(on)}$) and yet maintain superior switching performance, making it ideal for high-efficiency power management applications.

- Motor Control
- Backlighting
- AC-DC Converters

Mechanical Data

- Case: TO251
- Case Material: Molded Plastic, "Green" Molding Compound.
UL Flammability Classification Rating 94V-0
- Moisture Sensitivity: Level 1 per J-STD-020
- Terminal Connections: See Diagram
- Terminals: Finish – Matte Tin Annealed over Copper Leadframe.
Solderable per MIL-STD-202, Method 208 **(e3)**
- Weight: 0.33 grams (Approximate)

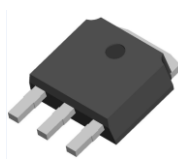

TO251
Top View

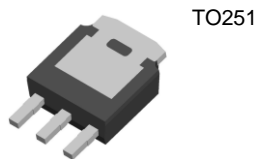

TO251
Bottom View

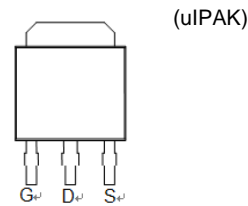

TO251
Top View
Pin Configuration

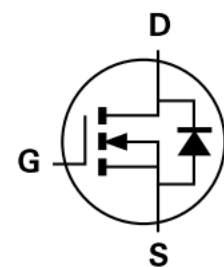

Internal Schematic

Ordering Information (Note 4)

Part Number	Case	Packaging
DMJ70H1D3SH3	TO251	75pieces / tube

- Notes:
1. EU Directive 2002/95/EC (RoHS) & 2011/65/EU (RoHS 2) compliant. All applicable RoHS exemptions applied.
 2. See http://www.diodes.com/quality/lead_free.html for more information about Diodes Incorporated's definitions of Halogen- and Antimony-free, "Green" and Lead-free.
 3. Halogen- and Antimony-free "Green" products are defined as those which contain <900ppm bromine, <900ppm chlorine (<1500ppm total Br + Cl) and <1000ppm antimony compounds.
 4. For packaging details, go to our website at <http://www.diodes.com/products/packages.html>.

Marking Information

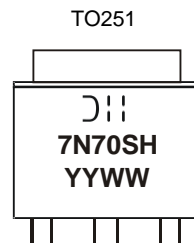

= Manufacturer's Marking
 7N70SH = Product Type Marking Code
 YYWW = Date Code Marking
 YY or YY = Last Digit of Year (ex: 15 = 2015)
 WW or WW = Week Code (01 to 53)

Maximum Ratings (@T_A = +25°C, unless otherwise specified.)

Characteristic	Symbol	Value	Units
Drain-Source Voltage	V _{DSS}	700	V
Gate-Source Voltage	V _{GSS}	±30	V
Continuous Drain Current (Note 5) V _{GS} = 10V	I _D	T _C = +25°C	4.6
		T _C = +100°C	2.9
Maximum Body Diode Forward Current (Note 6)	I _S	3.0	A
Pulsed Drain Current (10µs pulse, duty cycle = 1%)	I _{DM}	5.4	A
Avalanche Current (Note 7)	I _{AS}	1.1	A
Avalanche Energy (Note 7)	E _{AS}	40	mJ
Peak Diode Recovery dv/dt (Note 7)	dv/dt	5	V/ns

Thermal Characteristics (@T_A = +25°C, unless otherwise specified.)

Characteristic	Symbol	Value	Units
Total Power Dissipation (Note 5)	P _D	T _C = +25°C	41
		T _C = +100°C	16
Thermal Resistance, Junction to Ambient (Note 6)	R _{θJA}	79	°C/W
Thermal Resistance, Junction to Case (Note 5)	R _{θJC}	3.0	
Operating and Storage Temperature Range	T _J , T _{STG}	-55 to +150	°C

Electrical Characteristics (@T_A = +25°C, unless otherwise specified.)

Characteristic	Symbol	Min	Typ	Max	Unit	Test Condition
OFF CHARACTERISTICS (Note 8)						
Drain-Source Breakdown Voltage	BV _{DSS}	700	—	—	V	V _{GS} = 0V, I _D = 250µA
Zero Gate Voltage Drain Current	I _{DSS}	—	—	1	µA	V _{DS} = 700V, V _{GS} = 0V
Gate-Source Leakage	I _{GSS}	—	—	100	nA	V _{GS} = ±30V, V _{DS} = 0V
ON CHARACTERISTICS (Note 8)						
Gate Threshold Voltage	V _{GS(th)}	2	2.9	4	V	V _{DS} = V _{GS} , I _D = 250µA
Static Drain-Source On-Resistance	R _{DS(ON)}	—	1.0	1.3	Ω	V _{GS} = 10V, I _D = 2.5A
Diode Forward Voltage	V _{SD}	—	0.9	1.3	V	V _{GS} = 0V, I _S = 5A
DYNAMIC CHARACTERISTICS (Note 7)						
Input Capacitance	C _{iSS}	—	351	—	pF	V _{DS} = 50V, f = 1MHz, V _{GS} = 0V
Output Capacitance	C _{oss}	—	66	—		
Reverse Transfer Capacitance	C _{rSS}	—	1.1	—		
Gate Resistance	R _G	—	3.5	—	Ω	V _{DS} = 0V, V _{GS} = 0V, f = 1MHz
Total Gate Charge	Q _g	—	13.9	—	nC	V _{DD} = 560V, I _D = 5A, V _{GS} = 10V
Gate-Source Charge	Q _{gs}	—	1.9	—		
Gate-Drain Charge	Q _{gd}	—	8.5	—		
Turn-On Delay Time	t _{D(on)}	—	8.5	—	ns	V _{DD} = 350V, V _{GS} = 10V, R _G = 4.7Ω, I _D = 2.5A
Turn-On Rise Time	t _r	—	11.6	—		
Turn-Off Delay Time	t _{D(off)}	—	24.5	—		
Turn-Off Fall Time	t _f	—	10	—		
Body Diode Reverse Recovery Time	t _{rr}	—	212	—	ns	I _S = 5A, di/dt = 100A/µs
Body Diode Reverse Recovery Time (T _J = +150°C)	t _{rr}	—	251	—	ns	
Body Diode Reverse Recovery Charge	Q _{rr}	—	1.8	—	µC	
Body Diode Reverse Recovery Charge (T _J = +150°C)	Q _{rr}	—	2.3	—	µC	

- Notes:
- Device mounted on infinite heatsink.
 - Device mounted on FR-4 substrate PC board, 2oz copper, with minimum recommended pad layout.
 - Guaranteed by design. Not subject to production testing.
 - Short duration pulse test used to minimize self-heating effect.

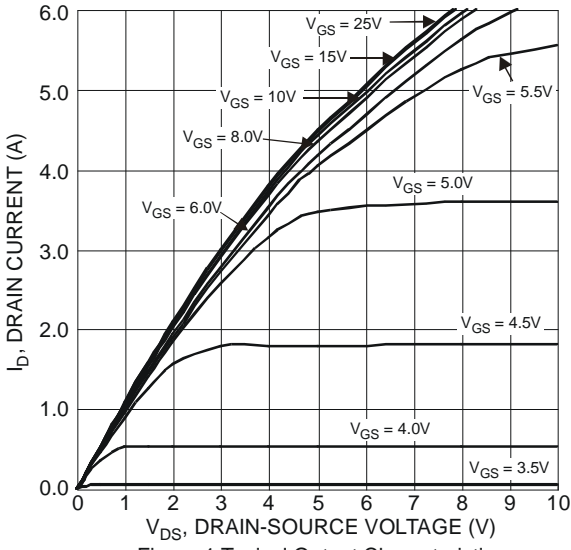

Figure 1 Typical Output Characteristics

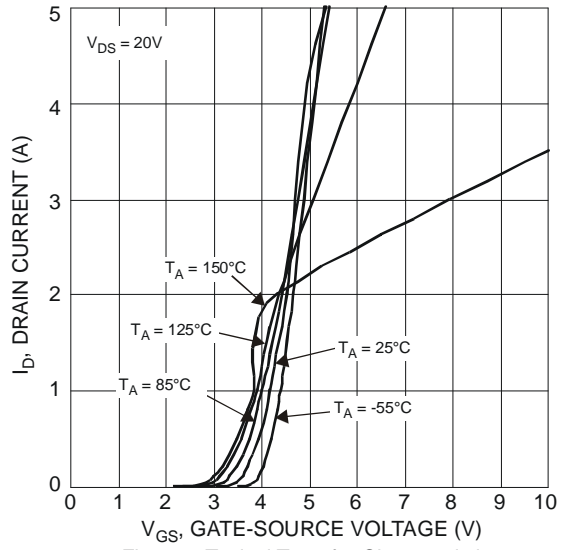

Figure 2 Typical Transfer Characteristics

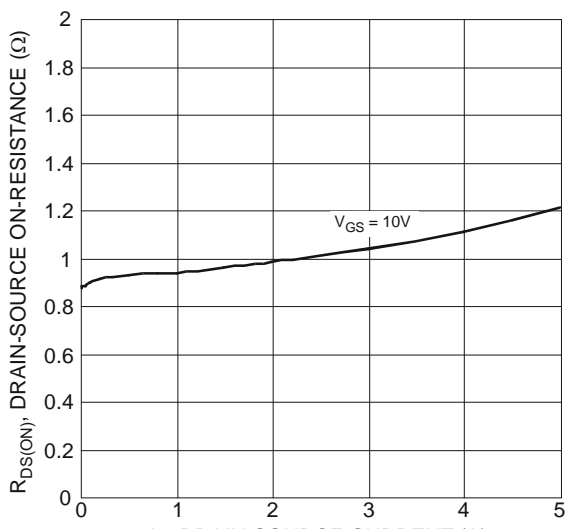

Figure 3 Typical On-Resistance vs. Drain Current and Gate Voltage

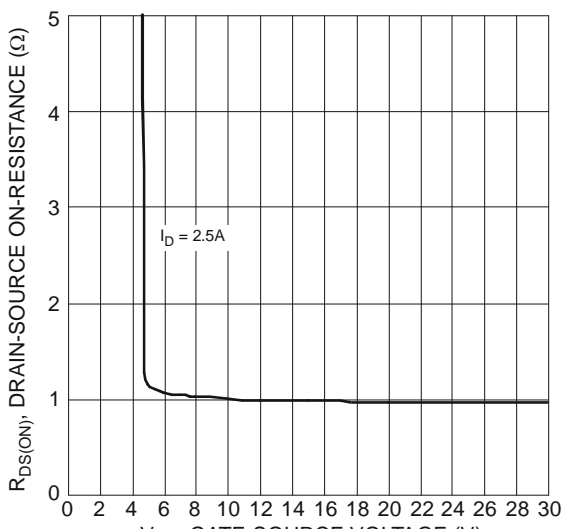

Figure 4 Typical Transfer Characteristics

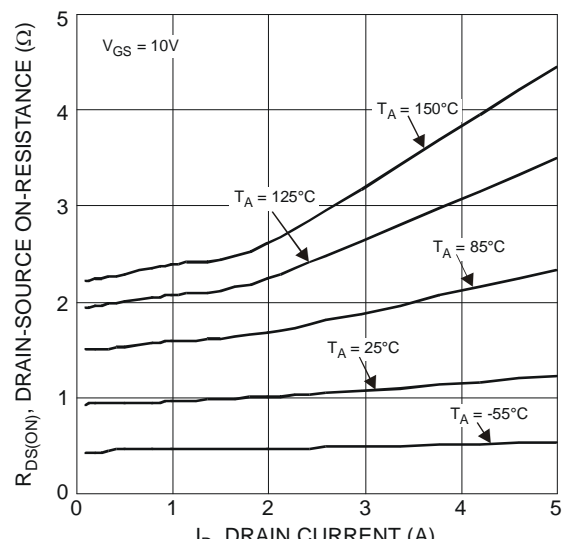

Figure 5 Typical On-Resistance vs. Drain Current and Temperature

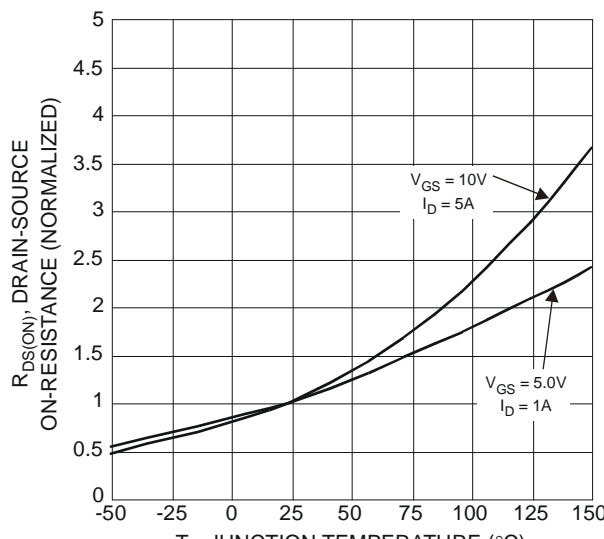

Figure 6 On-Resistance Variation with Temperature

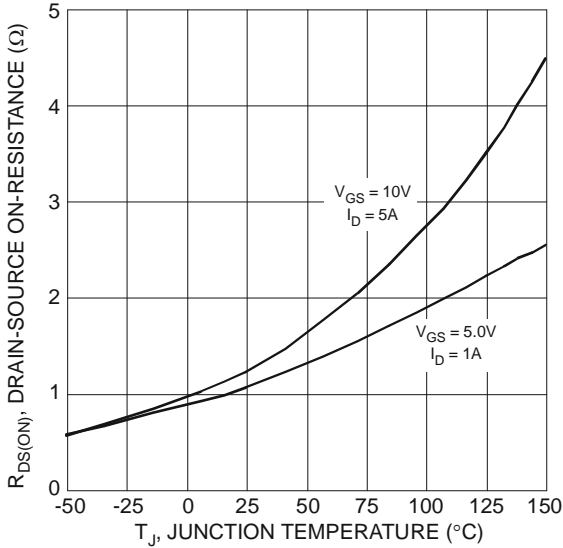

Figure 7 On-Resistance Variation with Temperature

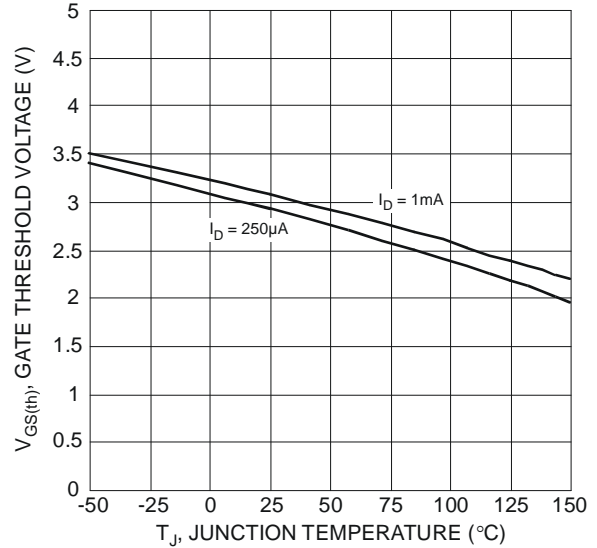

Figure 8 Gate Threshold Variation vs. Ambient Temperature

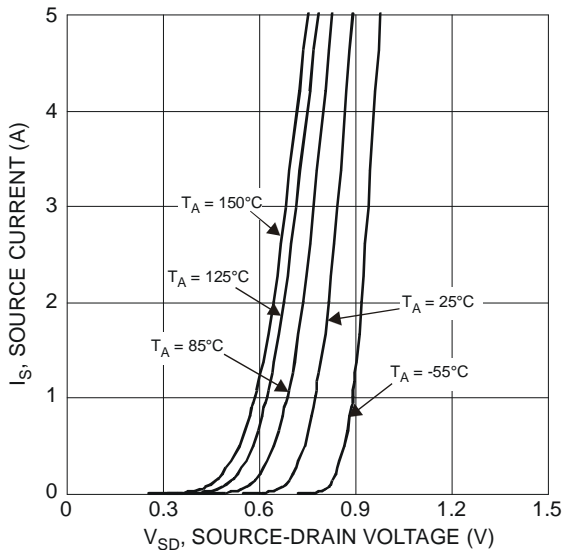

Figure 9 Diode Forward Voltage vs. Current

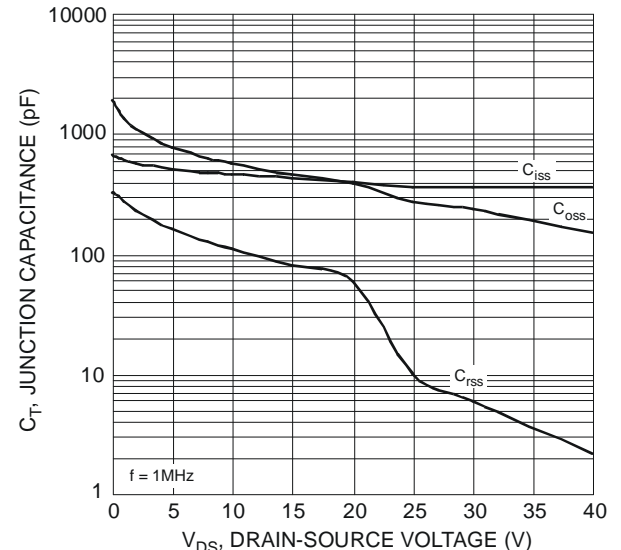

Figure 10 Typical Junction Capacitance

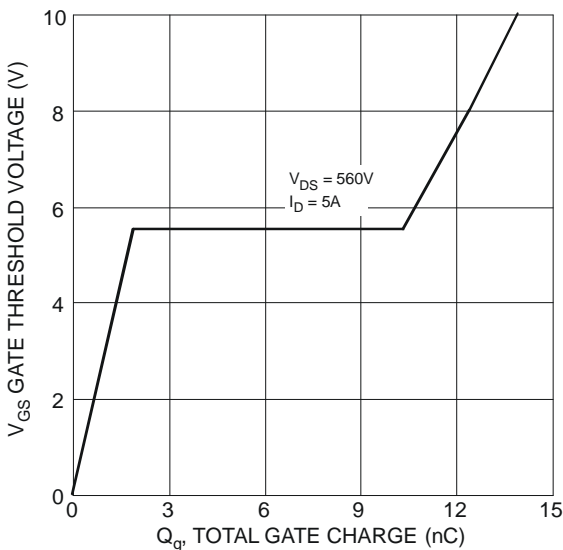

Figure 11 Gate Charge

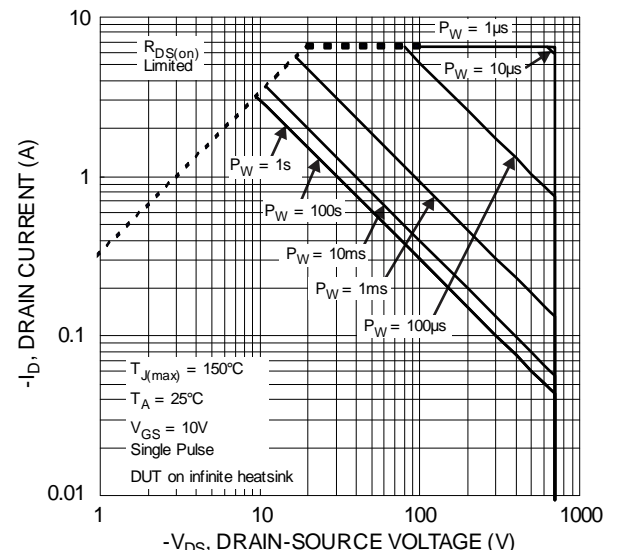
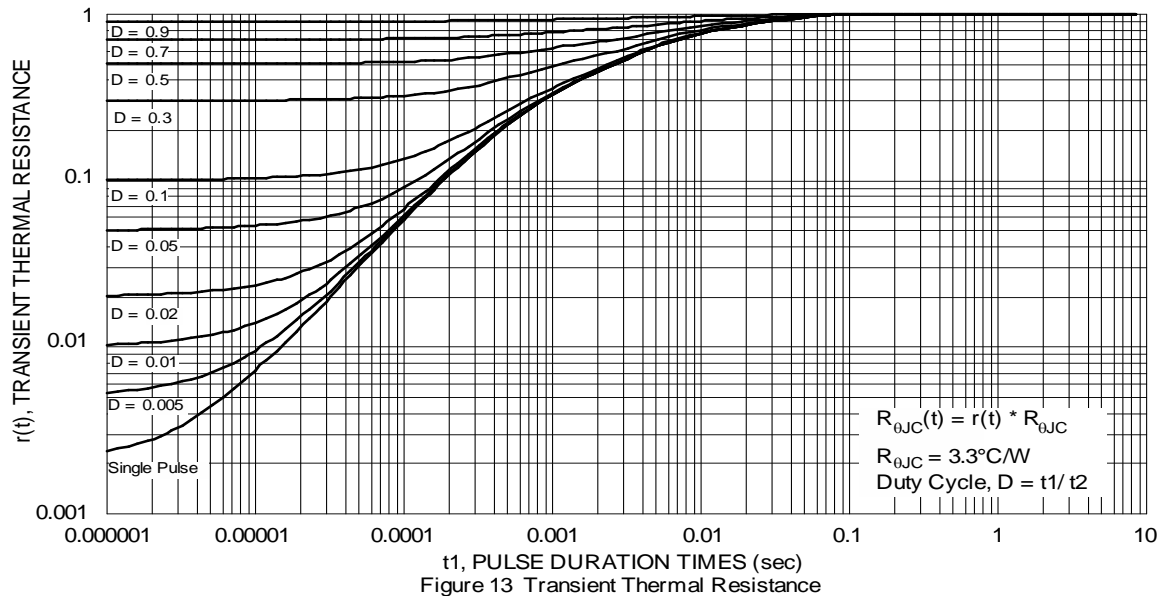
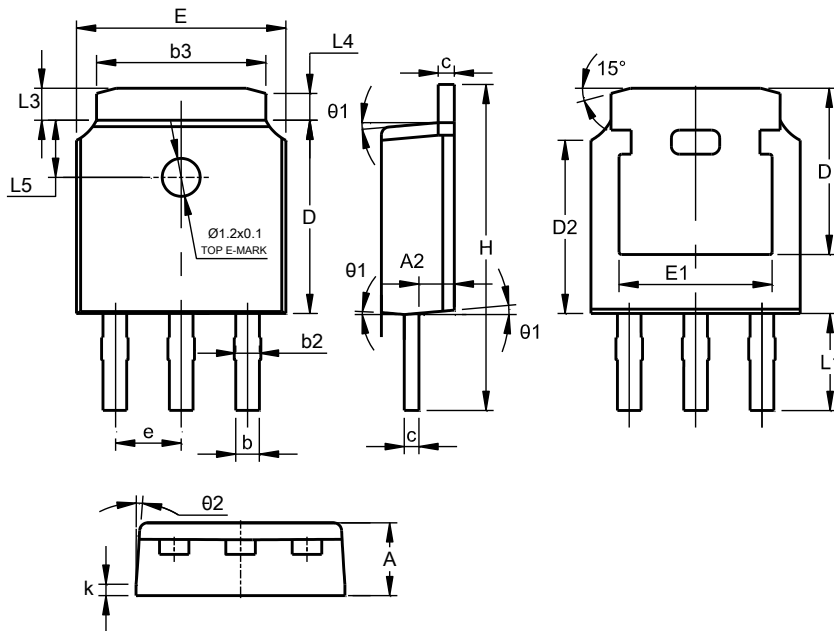

Figure 12 SOA, Safe Operation Area



Package Outline Dimensions

Please see AP02002 at <http://www.diodes.com/datasheets/ap02002.pdf> for the latest version.



TO251 (Type TH3)			
Dim	Min	Max	Typ
A	2.20	2.40	2.30
A2	0.97	1.17	1.07
b	0.68	0.90	0.78
b2	0.76	0.95	0.84
b3	5.20	5.50	5.33
c	0.43	0.63	0.53
D	5.98	6.22	6.10
D1	5.30 REF		
D2	5.26	5.66	5.46
e	2.286 BSC		
E	6.40	6.80	6.60
E1	4.63	5.03	4.83
H	9.40	9.85	9.62
k	0.40REF		
L1	2.30	2.70	2.50
L3	0.88	1.28	1.02
L4	0.75 REF		
L5	1.65	1.95	1.80
theta1	5°	9°	7°
theta2	5°	9°	7°
All Dimensions in mm			

IMPORTANT NOTICE

DIODES INCORPORATED MAKES NO WARRANTY OF ANY KIND, EXPRESS OR IMPLIED, WITH REGARDS TO THIS DOCUMENT, INCLUDING, BUT NOT LIMITED TO, THE IMPLIED WARRANTIES OF MERCHANTABILITY AND FITNESS FOR A PARTICULAR PURPOSE (AND THEIR EQUIVALENTS UNDER THE LAWS OF ANY JURISDICTION).

Diodes Incorporated and its subsidiaries reserve the right to make modifications, enhancements, improvements, corrections or other changes without further notice to this document and any product described herein. Diodes Incorporated does not assume any liability arising out of the application or use of this document or any product described herein; neither does Diodes Incorporated convey any license under its patent or trademark rights, nor the rights of others. Any Customer or user of this document or products described herein in such applications shall assume all risks of such use and will agree to hold Diodes Incorporated and all the companies whose products are represented on Diodes Incorporated website, harmless against all damages.

Diodes Incorporated does not warrant or accept any liability whatsoever in respect of any products purchased through unauthorized sales channel. Should Customers purchase or use Diodes Incorporated products for any unintended or unauthorized application, Customers shall indemnify and hold Diodes Incorporated and its representatives harmless against all claims, damages, expenses, and attorney fees arising out of, directly or indirectly, any claim of personal injury or death associated with such unintended or unauthorized application.

Products described herein may be covered by one or more United States, international or foreign patents pending. Product names and markings noted herein may also be covered by one or more United States, international or foreign trademarks.

This document is written in English but may be translated into multiple languages for reference. Only the English version of this document is the final and determinative format released by Diodes Incorporated.

LIFE SUPPORT

Diodes Incorporated products are specifically not authorized for use as critical components in life support devices or systems without the express written approval of the Chief Executive Officer of Diodes Incorporated. As used herein:

A. Life support devices or systems are devices or systems which:

1. are intended to implant into the body, or
2. support or sustain life and whose failure to perform when properly used in accordance with instructions for use provided in the labeling can be reasonably expected to result in significant injury to the user.

B. A critical component is any component in a life support device or system whose failure to perform can be reasonably expected to cause the failure of the life support device or to affect its safety or effectiveness.

Customers represent that they have all necessary expertise in the safety and regulatory ramifications of their life support devices or systems, and acknowledge and agree that they are solely responsible for all legal, regulatory and safety-related requirements concerning their products and any use of Diodes Incorporated products in such safety-critical, life support devices or systems, notwithstanding any devices- or systems-related information or support that may be provided by Diodes Incorporated. Further, Customers must fully indemnify Diodes Incorporated and its representatives against any damages arising out of the use of Diodes Incorporated products in such safety-critical, life support devices or systems.

Copyright © 2015, Diodes Incorporated

www.diodes.com

X-ON Electronics

Largest Supplier of Electrical and Electronic Components

Click to view similar products for [MOSFET](#) category:

Click to view products by [Diodes Incorporated](#) manufacturer:

Other Similar products are found below :

[614233C](#) [648584F](#) [MCH3443-TL-E](#) [MCH6422-TL-E](#) [FDPF9N50NZ](#) [FW231A-TL-E](#) [APT5010JVR](#) [NTNS3A92PZT5G](#) [IRF100S201](#)
[JANTX2N5237](#) [2SK2464-TL-E](#) [2SK3818-DL-E](#) [FCA20N60_F109](#) [FDZ595PZ](#) [STD6600NT4G](#) [FSS804-TL-E](#) [2SJ277-DL-E](#) [2SK1691-DL-](#)
[E](#) [2SK2545\(Q,T\)](#) [D2294UK](#) [405094E](#) [423220D](#) [MCH6646-TL-E](#) [TPCC8103,L1Q\(CM](#) [367-8430-0972-503](#) [VN1206L](#) [424134F](#) [026935X](#)
[051075F](#) [SBVS138LT1G](#) [614234A](#) [715780A](#) [NTNS3166NZT5G](#) [751625C](#) [873612G](#) [IRF7380TRHR](#) [IPS70R2K0CEAKMA1](#)
[RJK60S3DPP-E0#T2](#) [RJK60S5DPK-M0#T0](#) [APT5010JVFR](#) [APT12031JFLL](#) [APT12040JVR](#) [DMN3404LQ-7](#) [NTE6400](#) [JANTX2N6796U](#)
[JANTX2N6784U](#) [JANTXV2N5416U4](#) [SQM110N05-06L-GE3](#) [SIHF35N60E-GE3](#) [2SK2614\(TE16L1,Q\)](#)