



**THE BOOK**  
of  
**TEST ACCESSORIES**



# Introduction

## About Cal Test Electronics

Since 1995, Cal Test Electronics has provided high quality accessories to an ever-evolving test and measurement market. From the standard to the unique, Cal Test offers solutions to fit any need.

Founded to provide original equipment manufacturers (OEMs) with custom test accessory solutions, the company has expanded, supplying its own name-brand products to a network of world-class distributors. In 2009, Cal Test purchased Global Specialties along with their offering of educational electronic products.



For most of its 20-year history, Cal Test has enjoyed a close relationship with B&K Precision Corporation, a prominent test instrument manufacturer, through a mutual shareholder position. Although both companies maintain separate corporate identities, their strong affiliation allows each to stay at the forefront of their respective markets. Their joint relationship allows B&K Precision to market the Global Specialties educational line through its international distributors, and Cal Test to be the sole supplier of test accessories to the B&K Precision instrument line.

To strengthen its European presence, Cal Test partners with Sefram Instruments SAS, a B&K Precision subsidiary, and markets selected products under the ELDITEST brand, a time-honored name in Europe.

With the 2013 acquisition of Pintek Electronics, Ltd., a well-known and respected Taiwanese test equipment manufacturer, Cal Test significantly increased its resources for manufacturing both standard and custom products.

Today, Cal Test provides one of the most complete test accessory offerings available on the market, which include:

- Oscilloscope probes – passive, active, and high voltage
- DMM probes, leads, and complete accessory kits
- Banana plugs, jacks, and test lead assemblies
- Coaxial adapters and cable assemblies
- Test lead wire and storage racks

By following the latest technological advances in electronics, Cal Test regularly develops and introduces new products to meet the ever-changing needs of the test and measurement industry. We look forward to serving you in the decades to come.

Sincerely,  
*Bill Hansen, President*

## 20 Years of Service Excellence

Customers have been relying on Cal Test Electronics for more than 20 years. We have a time proven commitment to providing the best service, quality, selection and value.

## Technical Assistance

Expert help is just a phone call away. Our product managers are ready to answer your technical questions or to provide assistance in selecting the right product for your application.

## Warranty

Every new Cal Test accessory comes with a standard 1-year warranty against defects from the original date of purchase.

## Distribution

An extensive network of independent distributors provides Cal Test Electronics products worldwide. Visit our website for a list of authorized distributors.

## Web

For the most up-to-date product information, news, and support, visit our website at:

[caltestelectronics.com](http://caltestelectronics.com)



Also visit:  
[globalspecialties.com](http://globalspecialties.com)

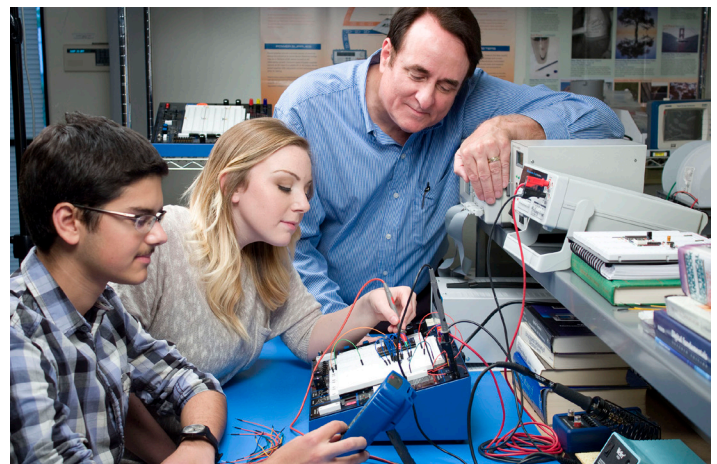
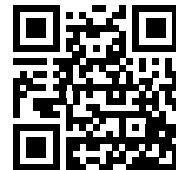



## Test Lead Builder

Along with its extensive offering of standard products, Cal Test has the capability of building custom accessories as required to meet your specific needs.

Our website features a custom Test Lead Builder which allows you to configure a special test lead to exactly fit the needed application. Just make some easy selections and you will be presented with all pertinent information.

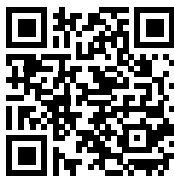

Scan QR code to view the Test Lead Builder.

Select:



## New Products..... 4-5

## Oscilloscope Probes & Accessories..... 6

- Active FET ..... 7
- Differential..... 8-12
- Passive ..... 13-14, 16-21
- High Voltage..... 15
- Current..... 22-23
- Accessories..... 7, 10, 14, 20-21

## Digital Multimeter Probes & Accessories..... 24

- Probes with Leads..... 25-26
- RF & High Voltage Probes ..... 26
- Probe Bodies ..... 27-28
- Probe Accessories..... 29
- 3900 Series Probes ..... 30-31
- Fused Probes..... 32-33

## Clips..... 34

- Alligator ..... 35-39
- Spring (Crocodile) & Plier Type..... 40
- Telecom & Kelvin ..... 41
- SMD Clips ..... 42-46
- SMD Tweezers ..... 45

## Coaxial..... 47

- Adapters ..... 48-53
- Kits..... 53
- Attenuators..... 54-55
- Terminators..... 55
- Cable Assemblies..... 56
- Cable Breakouts..... 57

## Banana Jacks..... 58

- In-Line DIY Assembly ..... 59
- Panel Mount & Accessories ..... 60, 61, 63
- PCB Mount..... 62
- Binding Posts..... 63
- Adapters..... 62

## Banana Plugs..... 64

- Standard ..... 65
- Double ..... 66
- Sheath..... 66-67
- Retractable Sleeve ..... 68
- Test Leads ..... 69-73

## Test Lead Wires..... 74

- Silicone & PVC Jacketed..... 75
- Test Lead Racks..... 76

## Kits..... 77

- Power Supply..... 78
- Function Generator & Frequency Counter ..... 79
- Spectrum Analyzer..... 80
- Oscilloscope..... 81
- Digital Multimeter..... 82-87

## Technical Reference..... 88-89

## Index..... 90-91





## AC/DC Clamp-On Current Probes ELDITEST Brand

- 8 models available
  - Current ranges: 40, 50, 70 & 100 A
  - Bandwidths: 300 kHz, 500 kHz, 1 MHz & 1.5 MHz
  - Dual sensitivity ranges & over-range indicator
  - Includes adapter for either North America (120 V 60 Hz), or European (230 V 50 Hz) mains
  - Full accessories included
- For full Specs see page 22

Model	CP6000 Series
-------	---------------



## High Voltage Differential Probes ELDITEST Brand

- Model CT4076: 35 MHz, 100x/1000x  
 Model CT4079: 50 MHz, 200x/2000x  
 Model CT4078: 120 MHz, 30x to 3000x
- For full Specs see page 11

Model	CT4076, CT4079, CT4078
-------	------------------------



## BNC Coaxial Terminators

- Model CT2944-50: 50 Ω  
 Model CT2944-75: 75 Ω  
 Model CT2944-93: 93 Ω
- For full Specs see page 55

Model	CT2944-50, CT2944-75, CT2944-93
-------	---------------------------------



## General Purpose Differential Probes ELDITEST Brand

- Bandwidth: 35 MHz
  - Attenuation: 10x/100x
- For full Specs see page 9

Model	CT4068
-------	--------



## High Voltage Oscilloscope Probes ELDITEST Brand

- Model CT4024: 40 MHz, 1000x  
 Model CT4025: 120 MHz, 100x  
 Model CT4026: 150 MHz, 1000x  
 Model CT4028: 220 MHz, 1000x
- For full Specs see page 15

Model	CT4024, CT4025, CT4026, CT4028
-------	--------------------------------



## Insulated BNC to 4mm Banana Plugs

- Insulated BNC female to double banana plugs.
- Model CT3888: <30 VAC / <60 VDC  
 Model CT3889: 1,000 V CAT II / 600 V CAT III
- For full Specs see page 50

Model	CT3888, CT3889
-------	----------------



## Active FET Oscilloscope Probe ELDITEST Brand

- 1.2 GHz bandwidth
  - 10x attenuation
  - Low 3 pF input capacitance
  - Over-range indicator
  - USB adapter and battery power included
  - Full accessories included
- For full Specs see page 7

Model	CT4121
-------	--------



## Fused Probes ELDITEST Brand

- IEC rating 1,000 V CAT III / 600 V CAT IV w/protective cap
  - Replaceable 1,000 VAC / VDC, 11 A, 20 kA IR fast-acting fuse
  - Special circuit prevents hazardous “zero” reading in blown fuse situation
- Model CT3999: Probe set  
 Model CT3997: Probe body  
 Model CT3998-11A: Replacement fuse
- For full Specs see page 32

Model	CT3999, CT3997, CT3998-11A
-------	----------------------------



## In-Line 4mm Banana Jacks Sheath, Fully Insulated, DIY Assembly, Solder

- 1,000 V CAT III / 600 V CAT IV, 36 A
  - Do-it-yourself connection
- For full Specs see page 59

Model	CT3134-S-#
-------	------------





## Electrical DMM Kit

- IEC 61010-031 rated accessories
- Cap on probe body tip provides CAT III / CAT IV rating
- Silicone jacketed lead wire
- Extra large alligator clips for electrical work
- Includes tri-fold nylon pouch

For full Specs see page 85

Model	CT2621C
-------	---------



## Basic Electrical DMM Kit

- IEC 61010-031 rated accessories
- Silicone jacketed lead wire
- Cap on probe body tip provides CAT III / CAT IV rating
- Includes tri-fold nylon pouch

For full Specs see page 85

Model	CT3738C
-------	---------



## General Purpose Handheld DMM Kit

- IEC 61010-031 rated accessories
- Cap on probe body tip provides CAT III / CAT IV rating
- Sprung hooks snap-lock to probe bodies
- Silicone jacketed lead wire
- Right-angle 4 mm sheath banana plug for hand-held meter connection
- Packaged in clear PVC pouch

For full Specs see page 82

Model	CT2696C
-------	---------



## 4mm Banana Plugs Sheath, In-Line, Solder

- 1,000 V CAT III / 600 V CAT IV, 36 A
- Do-it-yourself safety plugs

For full Specs see page 66

Model	CT2989-S-#
-------	------------



## 4mm Banana Plugs Sheath, Right-Angle, Solder

- 1,000 V CAT III / 600 V CAT IV, 20 A
- Do-it-yourself safety plugs

For full Specs see page 67

Model	CT3203-S-#
-------	------------



## 4mm Banana Plugs Sheath, Stacking, Solder

- 1,000 V CAT III / 600 V CAT IV, 36 A
- Do-it-yourself safety plugs

For full Specs see page 67

Model	CT2631-S-#
-------	------------



## 4mm Banana Plugs Retractable Sleeve, In-Line, Solder

- 600 V CAT II, 36 A
- Do-it-yourself safety plugs

For full Specs see page 68

Model	CT3201-S-#
-------	------------



## General Purpose Bench DMM Kit

- IEC 61010-031 rated accessories
- Cap on probe body tip provides CAT III / CAT IV rating
- Sprung hooks snap-lock to probe bodies
- Silicone jacketed lead wire
- Straight 4 mm sheath banana plugs for bench meters
- Extra large alligator clips
- Packaged in clear PVC pouch

For full Specs see page 87

Model	CT2695C
-------	---------





## Oscilloscope Probes

Most electronic testing requires some type of measurement probe in conjunction with a test instrument to safely and accurately access a device under test. With so many different oscilloscope probes to choose from, our goal is to make it easy for you to locate the probe that meets your needs. Whether you are looking for a simple passive, differential, current or a full featured active FET probe, you will be able to quickly scan through our extensive offerings to find the model that's just right for you.

Active FET .....	7
Differential.....	8-12
Passive .....	13-14, 16-21
High Voltage .....	15
Current .....	22-23
Accessories .....	7, 10, 14, 20-21





**New**

## Active FET Oscilloscope Probe ELDITEST Brand

Introducing a high performance active probe to extend the functionality of general-purpose oscilloscopes. The cost effective ELDITEST CT4121 probe features a compact active FET probe with a 1.2 GHz bandwidth and low 1 M $\Omega$ , 3 pF input impedance. The probe is ideal for analysis, troubleshooting, and verification of high-speed logic and communication designs. Includes a USB power lead that allows the probe to be powered directly by the scope, or alternatively, a 9 V battery (included) for portability. The BNC feed-thru terminator matches the probe to 1 M $\Omega$  fixed input oscilloscopes.

- Meets IEC 61010-031 safety standards
- Power and over-range indicator
- USB or battery power
- RoHS (2011/65/EU) compliant
- Also uses power adapter Model CT3723 (not included)
- Kit comes in foam-lined case and contains:
  - (1) Active FET probe
  - (1) USB Power lead
  - (1) 9 V Battery
  - (1) 50  $\Omega$  feed-thru terminator
  - (1) Accessory kit (see CT4123)
  - (1) User manual

Model	CT4121
Bandwidth	DC to 1.2 GHz
Accuracy	$\pm 2\%$
Input Impedance	1 M $\Omega$ /3 pF (Typical)
Attenuation	10:1
Risetime	291 ps
Input Voltage:	
• Max Differential (DC+Peak AC)	$\pm 15$ V
• Absolute Max Voltage (DC+Peak AC)	$\pm 40$ V
Output Voltage:	
• Swing (into 50 $\Omega$ load)	$\pm 1.5$ V
• Offset (Typical)	$< \pm 5$ mV
Adjustable Output Offset Range	$> -28$ mV to $+28$ mV
Output Impedance	50 $\Omega$
Output Cable (BNC)	120 cm
Power Requirements	5 VDC to 9 VDC / 200 mA
Operating Temperature/Humidity	$-10$ to $+40^{\circ}\text{C}$ / 0 to 85% RH
Storage Temperature/Humidity	$-30$ to $+70^{\circ}\text{C}$ / 0 to 85% RH
Dimensions	83 x 19 x 14 mm
Weight	200 g w/o battery

## Active FET Probe Accessories



### BNC Feed-Thru Terminator

- | Model | CT2944-50 |
|-------|-----------|
|-------|-----------|
- Impedance: 50  $\Omega$   
 Frequency Range: DC to 2 GHz
- See page 55 for complete specifications
  - RoHS (2011/65/EU)



### USB Power Lead

- | Model | CT4122 |
|-------|--------|
|-------|--------|
- Length: 200 cm
- USB to 3.5 mm power plug
  - Center pin positive
  - RoHS (2011/65/EU)

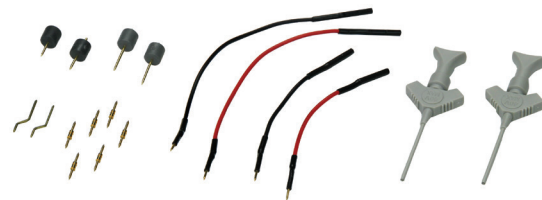

### Connection Accessory Kit

- | Model | CT4123 |
|-------|--------|
|-------|--------|
- RoHS (2011/65/EU)
  - Kit contains:
    - (2) SMD test clip, grey (CT3659-8)
    - (2) MicroLeads, 0.8 mm, P-J, 5 cm, B/R
    - (2) MicroLeads, 0.8 mm, P-J, 10 cm, B/R
    - (2) Ground pin, bent
    - (2) Test tip, insulated, 0.8 mm, 12.8 mm
    - (2) Test tip, insulated, 0.8 mm, 16.8 mm
    - (6) Test tip, un-insulated, 0.8 mm, 11.6 mm

# Oscilloscope Probes

## Differential



CT2593-1  
CT2593-2



CT3686  
CT3687

### General Purpose Differential Probes

Differential probes allow safe, accurate measurement between two voltage points where neither point is referenced to ground. The three models feature 2 attenuation settings, bandwidths to 100 MHz and differential voltages up to 1,400 V. Compatible with oscilloscopes from all major manufacturers, the probes can be battery operated or powered by a universal power adapter (not included). Models CT2593-1 & -2 include protective rubber boots. Models CT3686 & CT3687 feature power and over-range indicators.

- Meet IEC 61010-031 safety standards
- RoHS (2011/65/EU) compliant
- Use power adapter CT3723 (not included)
- Kits contain:
  - (1) Differential probe
  - (2) Hook probes, black & red
  - (4) AA batteries
  - (1) User manual

Model	CT2593-1	CT2593-2	CT3686	CT3687
Bandwidth	25 MHz		100 MHz	
Attenuation	20x/200x	10x/100x		100x/1000x
Accuracy	±2%			
Risetime	14 ns		3.5 ns	
Input Impedance	4 MΩ//5.5 pF			4 MΩ//7 pF
Input Voltage:				
Differential Voltage (DC+Peak AC)	±140 V/±1,400 V	±70 V/±700 V		±140 V/±1,400 V
Common-Mode Voltage (DC+Peak AC)	±1,400 V	±700 V	±700 V or 500 Vrms	±1,400 V or 1,000 Vrms
Absolute Max Voltage (DC+Peak AC)	±1,400 V		±1,400 V or 1,000 Vrms CAT III	
Output Voltage:				
Swing	±7 V (into 50 kΩ load)			
Offset (Typ.)	±5 mV			
Noise (Typ.)	0.7 mVrms		0.9 mVrms	
Source Impedance (Typ.)	50 kΩ			
CMRR (Typ.)	-86 dB@50 Hz; -66 dB@20 kHz		-85 dB@50 Hz; -55 dB@1 MHz	
Cable Length	95 cm			
Input Leads Length	45 cm		30 cm	
Weight	400 g		500 g	
Dimensions	170 x 63 x 21 mm		202 x 83 x 38 mm	





CT4068-NA  
CT4068-EU

**New**

### General Purpose Differential Probes ELDITEST Brand

ELDITEST general-purpose differential probes allow for safe, accurate measurements between two voltage points where neither point is referenced to ground.

Model CT4068 features 10x/100x attenuation settings, 35 MHz bandwidth and  $\pm 800$  V maximum differential - all in a compact, safety yellow housing. Compatible with oscilloscopes from all major manufacturers, the probe is ideal where high sensitivity and dynamic range is needed. The included power adapter is available for either North American (120 V 60 Hz) or European (220 V 50 Hz) mains.

- Meet IEC 61010-031 safety standards
- Power and over-range indicators
- RoHS (2011/65/EU) compliant
- Kits contain:

- (1) Differential probe
- (2) Pincer clips, black & red
- (2) Alligator clips, black & red
- (2) Banana plug leads, black & red
- (1) Insulated BNC cable
- (1) Power adapter
- (1) User manual

*Model	CT4068-NA CT4068-EU
Bandwidth	35 MHz
Attenuation	10x/100x
Accuracy	$\pm 2\%$
Risetime	10 ns
Input Impedance	9 M $\Omega$ //1.7 pF
Input Voltage:	
Differential Voltage (DC+Peak AC)	$\pm 80$ V / $\pm 800$ V
Common-Mode Voltage (DC+Peak AC)	$\pm 800$ V or 560 Vrms
Absolute Max Voltage (DC+Peak AC)	$\pm 800$ V or 560 Vrms
Output Voltage:	
Swing	$\pm 8$ V ( $\pm 4$ V into 50 $\Omega$ load)
Offset (Typ.)	$\leq 5$ mVDC
Noise (Typ.)	$\leq 1$ mVrms
Source Impedance (Typ.)	50 $\Omega$
CMRR (Typ.)	-80 dB@60 Hz; -60 dB@100 Hz; -50 dB@1 MHz
Cable Length	100 cm (separate leads)
Input Leads Length	60 cm (separate leads)
Weight	250 g
Dimensions	195 x 55 x 30 mm

\* Suffix for Power Adapter: – NA North American style plugs  
– EU European style plugs

# Oscilloscope Probes

## Differential



CT3681



CT3683

## High Voltage Differential Probes

High voltage differential probes allow for safe, accurate measurements between two voltage points where neither point is referenced to ground and voltages reach to  $\pm 7,000$  V.

Models CT3681 and CT3683 feature 100x/1000x attenuation settings, 70 MHz bandwidth and  $\pm 7,000$  V maximum differential. Compatible with oscilloscopes from all major manufacturers, the probes can be battery operated or powered by a universal power adapter (not included).

- Meet IEC 61010-031 safety standards
- Power and over-range indicators
- RoHS (2011/65/EU) compliant
- Use power adapter CT3723 (not included)
- Kits contain:
  - (1) Differential probe
  - (2) Hook probes, black & red (CT3681)
  - (2) HV Alligator clips, black & red (CT3683)
  - (4) AA batteries
  - (1) User manual

Model	CT3681	CT3683
Bandwidth	70 MHz	
Attenuation	100x/1000x	
Accuracy	$\pm 2\%$	
Risetime	5 ns	
Input Impedance	10 M $\Omega$ //10 pF	50 M $\Omega$ //7 pF
Input Voltage:		
Differential Voltage (DC+Peak AC)	$\pm 700$ V / $\pm 7$ kV	
Common-Mode Voltage (DC+Peak AC)	$\pm 7$ kV or 2.5 kVrms	$\pm 7$ kV or 5 kVrms
Absolute Max Voltage (DC+Peak AC)	$\pm 7$ kV or 2.5 kVrms	$\pm 7$ kV or 5 kVrms
Output Voltage:		
Swing	$\pm 7$ V (into 50 k $\Omega$ load)	
Offset (Typ.)	$\pm 5$ mV	
Noise (Typ.)	0.9 mVrms	
Source Impedance (Typ.)	50 k $\Omega$	
CMRR (Typ.)	-80 dB@50 Hz; -60 dB@20 kHz	
Cable Length	90 cm	
Input Leads Length	60 cm	
Weight	500 g	
Dimensions	202 x 83 x 38 mm	



CT3723

## Power Adapter for Differential Probes

- Switching adapter
- Length: 150 cm
- RoHS (2011/65/EU) compliant

Model	CT3723
Input Power	100-240 VAC 50/60 Hz
Output Power	9 VDC 500 mA
Output Plug	2.1 mm x 5.5 mm, Center Pin Positive
UL Listed	Yes
Use with Models	CT2593-1, CT2592-2, CT3681, CT3683, CT3686, CT3687, CT3684, CT3685, CT3688

## Differential



CT4076-NA  
CT4076-EU



CT4079-NA  
CT4079-EU

CT4078-NA  
CT4078-EU

**New**

## High Voltage Differential Probes ELDITEST Brand

ELDITEST high voltage differential probes allow for safe, accurate measurements between two voltage points where neither point is referenced to ground and voltages reach to  $\pm 15$  kV. Models CT4076 and CT4079 feature 100x/1000x and 200x/2000x attenuation ranges, respectively, while Model CT4078 features 5 attenuation settings from 30x to 3000x - all in a compact, safety yellow housing. Compatible with oscilloscopes from all major manufacturers, the probes are ideal where high sensitivity and wide dynamic range is needed. The included power adapters are available for either North American (120 V 60 Hz) or European (220 V 50 Hz) mains.

- Meet IEC 61010-031 safety standards
- Power and over-range indicators
- RoHS (2011/65/EU) compliant
- Kits contain:
  - (1) Differential probe
  - (2) HV pincer clips, black & red
  - (2) Alligator clips, black & red
  - (2) HV banana plug leads, black & red
  - (1) Insulated BNC cable
  - (1) Power adapter
  - (1) User manual

*Model	CT4076-NA CT4076-EU	CT4079-NA CT4079-EU	CT4078-NA CT4078-EU
Bandwidth	35 MHz	50 MHz	120 MHz
Attenuation	100x/1000x	200x/2000x	30x/100x/300x/1000x/3000x
Accuracy	$\pm 2\%$		
Risetime	10 ns	7 ns	3 ns
Input Impedance	50 M $\Omega$ //1.3 pF	40 M $\Omega$ //1.3 pF	100 M $\Omega$ //1.0 pF
Input Voltage:			
Differential Voltage (DC+Peak AC)	$\pm 750$ V / $\pm 7.5$ kV	$\pm 1.5$ kV / $\pm 15$ kV	$\pm 110$ V / $\pm 350$ V / $\pm 1.1$ kV / $\pm 3.5$ kV / $\pm 11$ kV
Common-Mode Voltage (DC+Peak AC)	$\pm 7.5$ kV or 5.5 kVms	$\pm 15$ kV or 10 kVms	$\pm 11$ kV or 7.8 kVms
Absolute Max Voltage (DC+Peak AC)	$\pm 7.5$ kV or 5.5 kVms	$\pm 15$ kV or 10 kVms	$\pm 11$ kV or 7.8 kVms
Output Voltage:			
Swing	$\pm 8$ V ( $\pm 4$ V into 50 $\Omega$ load)		$\pm 5$ V ( $\pm 2.5$ V into 50 $\Omega$ load)
Offset (Typ.)	$\leq 5$ mVDC		
Noise (Typ.)	$\leq 1$ mVrms	$< 1$ mVrms	
Source Impedance (Typ.)	50 $\Omega$		
CMRR (Typ.)	-80 dB@60 Hz; -60 dB@100 Hz; -50 dB@1 MHz		
Cable Length	100 cm (separate leads)		
Input Leads Length	60 cm (separate leads)		
Weight	350 g		
Dimensions	220 x 85 x 30 mm		245 x 76 x 32 mm

\* Suffix for Power Adapter: – NA North American style plugs  
– EU European style plugs



# Oscilloscope Probes

## Differential



## Precision Differential Probes

Precision differential probes allow for safe, accurate measurements between two voltage points where neither point is referenced to ground and high accuracy is required. These small size probes feature fixed 10x or 100x attenuation and bandwidths up to 200 MHz. Accuracy is  $\pm 1\%$  with the best CMRR in power measurement probes. Compatible with oscilloscopes from all major manufacturers, the probes can be battery operated or powered by a universal power adapter (not included).

- Meet IEC 61010-031 safety standards
- Compact probe bodies
- Power indicator
- RoHS (2011/65/EU) compliant
- Use power adapter CT3723 (not included)
- Kits come in a foam-lined plastic case and contain:
  - (1) Differential probe
  - (2) Hook clips, black & red
  - (1) User manual

Model	CT3684	CT3685	CT3688
Bandwidth	50 MHz		200 MHz
Attenuation	10x	100x	10x
Accuracy	$\pm 1\%$		
Risetime	7 ns		1.75 ns
Input Impedance	1.6 M $\Omega$ //7 pF	4 M $\Omega$ //7 pF	500 k $\Omega$ //7 pF
Input Voltage:			
Differential Voltage (DC+Peak AC)	$\pm 70$ V or 70 Vrms	$\pm 700$ V or 600 Vrms	$\pm 20$ V or 50 Vrms
Common-Mode Voltage (DC+Peak AC)	$\pm 700$ V or 600 Vrms	$\pm 1,400$ V or 600 Vrms	$\pm 60$ V or 40 Vrms
Absolute Max Voltage (DC+Peak AC)	$\pm 700$ V or 600 Vrms CAT II	$\pm 1,400$ V or 600 Vrms CAT II	$\pm 60$ V or 40 Vrms
Output Voltage:			
Swing	$\pm 7$ V		$\pm 2$ V (into 50 $\Omega$ load)
Offset (Typ.)	$< \pm 2$ mV	$< \pm 1$ mV	$\pm 2$ mV
Noise (Typ.)	0.7 mVrms	0.3 mVrms	
Source Impedance (Typ.)	50 $\Omega$		
CMRR (Typ.)	-95 dB@60 Hz; -60 dB@1 MHz	-90 dB@60 Hz; -55 dB@1 MHz	-80 dB@100 Hz; -50 dB@10 MHz
Cable Length	125 cm		
Input Leads Length	50 cm		
Weight	300 g		
Dimensions	111 x 22 x 14 mm		



CT3290RA

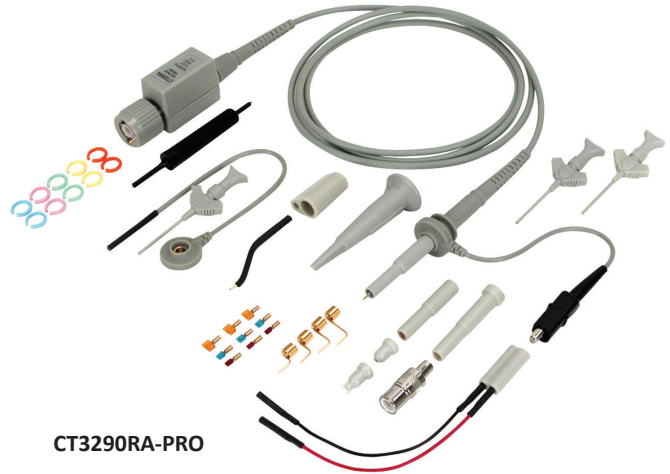

CT3290RA-PRO

Model	CT3290RA	CT3290RA-PRO
Bandwidth	500 MHz	
Attenuation	10x	
Input Impedance	10 MΩ	
Input Capacitance	8 pF	
Output Impedance	1 MΩ	
Risetime	0.7 ns	
IEC Rating	300 V CAT II	
Compensation	8–18 pF	
Cable Length	1.3 m	
Readout Actuator	Yes	

### Passive Voltage

### Compact Body, 3.5mm

### Replacement for Tektronix® P6139A\*

One of our highest frequency passive probes at 500 MHz. Excellent replacement probe when the application requires the utilization of high frequency scopes. Probes include a readout actuator pin (sense pin) on the BNC connector. Model CT3290RA comes complete with accessories, Model CT3290RA-PRO includes enhanced accessories (see images).

- IEC 61010-031 rated
- RoHS (2011/65/EU) compliant

Accessory	Kit Contains	
Attenuator Tip Cover	1	1
Slip-on GND Lead w/Alligator Clip	1	1
Sprung Hook, Grey	1	1
Deluxe Trimmer Tool	1	1
Low Impedance Ground Tip	1	1
Ground Collar	1	1
SMT IC Test Clip, Grey	1	3
Slip-on GND Lead w/0.6 mm Jack	1	1
Identifier Rings (5 x 2 colors)	1	1
Twin Lead Adapter, 3.5 mm	--	1
BNC Adapter, 3.5 mm	--	1
Cover Shell (no Slip-on GND)	--	1
Cover Shell (w/ Slip-on GND)	--	1
Probe Tip GNDs (0.1, 0.2, 0.3 & 0.4")	--	1
IC Tip Insulator	--	1
Tip Insulator	--	1
IC Lead Combs, 0.050" (Yellow)	--	3
IC Lead Combs, 0.025" (Blue)	--	3
IC Lead Combs, 0.5 mm (Red)	--	3

\* Tektronix® is a registered trademark of Tektronix, Inc.

# Oscilloscope Probes

## Passive & Accessories

### 3.5mm Oscilloscope Probe Accessories

- Compatible with all 3.5 mm compact oscilloscope probes
- RoHS (2011/65/EU) compliant



#### Ground Lead

Model	CT3645-12-8
-------	-------------

Specialized slip-on ground lead with miniature alligator clip. 12 cm long, color grey. Sold in package of 5.



#### Tip Insulator

Model	CT3646-8
-------	----------

Cover for the attenuator tip assembly, color grey. Sold in package of 10.



#### Sprung Hook

Model	CT3647-8
-------	----------

Probe sprung hook. Gold plated, color grey. Sold in package of 10.



#### Ground Tip

Model	CT3649
-------	--------

Low impedance 3.5 mm compact probe tip used in conjunction with ground collar CT3650-8 for low impedance grounding. Sold in package of 10.



#### Ground Collar

Model	CT3650-8
-------	----------

Collar for 3.5 mm compact probes used in conjunction with ground tip CT3649 for low impedance readings. Color grey. Sold in package of 10.



#### Cover Shell

Model	CT3652-8
-------	----------

Cover shell for 3.5 mm compact probes with slip-on ground. Used for connecting BNC adapter and probe tip grounds. Use in conjunction with tip Insulator CT3653-8. Color grey. Sold in package of 10.



#### Tip Insulator

Model	CT3653-8
-------	----------

Tip cover for 3.5 mm compact probes. Use in conjunction with cover shell CT3652-8. Color grey. Sold in package of 10.



#### IC Tip Insulator

Model	CT3654-8
-------	----------

Tip cover for IC probing. Replacement tip compatible with all 3.5 mm compact scope probes. Use in conjunction with cover shell CT3652-8. Color grey. Sold in package of 10.



#### BNC Adapter

Model	CT3655
-------	--------

Non-terminated BNC tip adapter. Use in conjunction with cover shell CT3652-8. Sold in package of 10.



#### Ground Lead

Model	CT3661-15-8
-------	-------------

Specialized ground lead. Slip-on ground with 0.6 mm pin jack. Use with SMT Test Clip, CT3659-8. 15 cm long. Color grey. Sold in package of 10.



#### Attenuator Tip

Model	CT3667
-------	--------

Replacement attenuator tip assembly, 10x, 500 MHz. Will work for both the CT3290RA and the CT3290RA-PRO. Sold in package of 5.

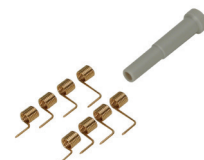

#### Cover Shell & Tip Grounds

Model	CT3672
-------	--------

Cover for attenuator tip assembly with probe tip grounds. Kit includes 2 each of 4 ground tip sizes: 0.1", 0.2", 0.3" and 0.4" spacing. Gold plated ground tips. Sold in package of 1.



#### IC Comb Kit

Model	CT3675
-------	--------

12-piece IC lead comb kit. Yellow, .050" lead centers. Gold plated. Sold in package of 1.



#### IC Comb Kit

Model	CT3676
-------	--------

12-piece IC lead comb kit. Blue, .025" lead centers. Gold plated. Sold in package of 1.



#### IC Comb Kit

Model	CT3677
-------	--------

12-piece IC lead comb kit. Red, 0.5 mm lead centers. Gold plated. Sold in package of 1.

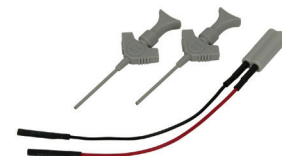

#### Twin Lead Adapter

Model	CT3678
-------	--------

Twin lead adapter with two SMT Test Clips. Use with cover shell. Sold in package of 1.



## High Voltage



**New**

### High Voltage Probes ELDITEST Brand

ELDITEST high voltage probes allow for safe and accurate voltage measurement using your oscilloscope. The five models feature both 100x or 1000x divider ratios with voltages up to 28 kVrms and bandwidths to 220 MHz. Compatible with oscilloscopes from all major manufacturers, the probes are required for safe user measurements.

Each probe comes with alternate tips and user manual.

- Meet IEC 61010-031 safety standards
- RoHS (2011/65/EU) compliant



**As with any high voltage instrument, please read and follow all user instructions.**

Model	CT4024	CT2982B	CT4025	CT4026	CT4028
Bandwidth	40 MHz	50 MHz	120 MHz	150 MHz	220 MHz
Attenuation	1000x		100x	1000x	
Input Impedance	100 MΩ			200 MΩ	900 MΩ
Input Capacitance	3 pF		2 pF	1.5 pF	2 pF
Output Impedance	1 MΩ				
Risetime	9 ns	7 ns	3 ns	2.4 ns	1.6 ns
Voltage Max (DC+AC peak)	8 kV	15 kV	10 kV CAT II	18 kV CAT II	40 kV CAT II
Voltage Max (ACrms)	6 kV	10 kV	7 kV CAT II	12 kV CAT II	28 kV CAT II
Compensation	5–50 pF		10–35 pF		
VDC Accuracy	±2% (DC to 5 kV) ±3% (5 kV to 8 kV)	±3% (DC to 15 kV)	≤3% Full Range		
VAC Accuracy	≤3% @ 1 kHz				
Cable Length	2 m ± 0.2 m				
Readout Actuator	--	--	Yes	--	--

### High Voltage Oscilloscope Probe Accessories

Can be used with all HV probes



#### Round Replacement Tip

**Model** CT2960A  
5 mm thread. Gold plated.  
Sold in package of 10.  
RoHS (2011/65/EU) compliant.



#### Hook Replacement Tip

**Model** CT2961A  
5 mm thread. Gold plated.  
Sold in package of 10.  
RoHS (2011/65/EU) compliant.



#### Flat Bar Replacement Tip

**Model** CT2962A  
5 mm thread. Gold plated.  
Sold in package of 10.  
RoHS (2011/65/EU) compliant.



#### BNC Converter

**Model** CT3197B  
Converter adapts high voltage oscilloscope probes for use with digital multimeters (DMMs).  
• Bandwidth: DC to 50 MHz  
• Meter impedance: 10 Ω  
• RoHS (2011/65/EU) compliant

# Oscilloscope Probes

## Passive



CT3288ARA

### Passive Voltage, 5mm

Cal Test's standard 5 mm passive voltage probes offer excellent quality and performance at an economical price. With low noise figures and wide compensation ranges, the probes work with oscilloscopes from all major manufacturers.

- Bandwidths to 500 MHz
- Fixed and switched attenuations
- Wide compensation ranges

- Selected models with readout actuators (sense pins)
- IEC 61010-031 rated
- Full accessories included
- Model CT3288ARA features enhanced accessory kit: (1) twin lead adapter, (3) SMT IC test clips, (1) GND lead with (1) 0.6 mm jack and probe top grounds (0.1, 0.2, 0.3 & 0.4")
- RoHS (2011/65/EU) compliant

## Fixed - 600 V Rated

Model	CT2678	CT2676A	CT2676ARA	CT2840RA	CT3133	CT3133RA	CT3288RA	CT3288ARA*
Bandwidth	15 MHz	100 MHz		250 MHz	350 MHz		500 MHz	
Attenuation	1x	10x						
Input Impedance	1 MΩ	10 MΩ						
Input Capacitance	46 pF	16 pF		14 pF	12 pF			
Output Impedance	1 MΩ							
Risetime	27 ns	3.5 ns		1.4 ns	1 ns		0.7 ns	
IEC Rating	300 V CAT II / 600 V CAT 0							
Compensation	--	10–35 pF					9–18 pF	
Cable Length	1.2 m							
Readout Actuator	No		Yes	Yes	No	Yes		

Accessory	Kit Contains							
Sprung Hook	1	1	1	1	1	1	1	1
GND Lead w/Alligator Clip	1	1	1	1	1	1	1	1
BNC Adapter	1	1	1	1	1	1	1	1
Replacement Tip	1	1	1	1	1	1	1	1
Probe Tip Ground	--	1	1	1	1	1	1	--
Trimmer Tool	--	1	1	1	1	1	1	1
IC Tip Insulator	1	1	1	1	1	1	1	1
Tip Insulator	1	1	1	1	1	1	1	1
Identifier Rings	--	--	--	--	1	1	1	1

\* CT3288ARA includes an enhanced kit described in copy above.

## Fixed - 1,200 V Rated

Model	CT2707
Bandwidth	250 MHz
Attenuation	100x
Input Impedance	100 MΩ
Input Capacitance	6.5 pF
Output Impedance	1 MΩ
Risetime	1.4 ns
IEC Rating	1,200 V CAT 0
Compensation	10–35 pF
Cable Length	1.2 m
Readout Actuator	No

Kit Contains	
Sprung Hook	1
GND Lead w/Alligator Clip	1
BNC Adapter	1
Replacement Tip	1
Trimmer Tool	1
IC Tip Insulator	1
Tip Insulator	1



CT2707



CT2675A

## Passive Voltage, 5mm (continued)

### Switchable - 600 V Rated

Model	CT2703	CT2674A	CT2704	CT2704SA	CT2675A	CT3277SA	CT2850	CT2841A
Bandwidth	15/60 MHz	6/100 MHz	15/100 MHz		10/200 MHz	6/250 MHz	10/250 MHz	15/350 MHz
Attenuation	1x/10x	1x/10x/REF	1x/10x		1x/10x/REF	1x/10x	1x/10x/REF	1x/10x
Input Impedance	1/10 MΩ							
Input Capacitance	46/18 pF	90/16 pF	45/16 pF		90/14 pF	47/17 pF	90/14 pF	90/12 pF
Output Impedance	1 MΩ							
Risetime	27/5.8 ns	58/3.5 ns	27/3.5 ns		35/1.8 ns	58/1.4 ns	35/1.4 ns	27/1.0 ns
IEC Rating	300 V CAT II / 600 V CAT 0							
Compensation	10–35 pF							
Cable Length	1.2 m							
Readout Actuator	No							
Insulated BNC	No		Yes		No	Yes	No	

Accessory	Kit Contains							
Sprung Hook	1	1	1	1	1	1	1	1
GND Lead w/Alligator Clip	1	1	1	1	1	1	1	1
BNC Adapter	1	1	1	1	1	1	1	1
Replacement Tip	1	1	1	1	1	1	1	1
Probe Tip Ground	--	1	1	1	1	1	1	1
Trimmer Tool	1	1	1	1	1	1	1	1
IC Tip Insulator	1	1	1	1	1	1	1	1
Tip Insulator	1	1	1	1	1	1	1	1
Identifier Rings	1	--	1	1	--	1	--	1



# Oscilloscope Probes

## Passive

### Passive Voltage, 5mm ELDITEST GE Series

SMD circuit technology provides low input capacitance and fast rise-times to the GE family of voltage probes. A wide compensation range allows use with oscilloscopes from all major manufacturers. The probes carry the ELDITEST brand name recognized internationally for quality and performance.

- Bandwidths to 500 MHz
- Fixed and switched attenuations
- Wide compensation ranges
- Selected models with readout actuators (sense pins)
- IEC 61010-031 rated
- Full accessories included
- RoHS (2011/65/EU) compliant



### Fixed - 600 V Rated

Model	GE1501	GE2501	GE1511	GE1511RA	GE2511	GE2511RA	GE4511RA
Bandwidth	30 MHz	55 MHz	150 MHz		250 MHz		500 MHz
Attenuation	1x			10x			
Input Impedance	1 MΩ			10 MΩ			
Input Capacitance	45 pF			12 pF			10 pF
Output Impedance	1 MΩ						
Risetime	11 ns	6.4 ns	2.3 ns		1.4 ns		0.7 ns
IEC Rating	300 V CAT II						
Compensation	No			10–30 pF			6–22 pF
Cable Length	1.2 m						
Readout Actuator	No			Yes	No	Yes	

Accessory	Kit Contains						
Sprung Hook	1	1	1	1	1	1	1
GND Lead w/Alligator Clip	1	1	1	1	1	1	1
BNC Adapter	1	1	1	1	1	1	1
Replacement Tip	1	1	1	1	1	1	1
Probe Tip Ground	--	1	1	1	1	1	1
Trimmer Tool	--	--	1	1	1	1	1
IC Tip Insulator	1	1	1	1	1	1	1
Tip Insulator	1	1	1	1	1	1	1
Identifier Rings	1	1	1	1	1	1	1

### Switchable - 600 V Rated

Model	GE1521	GE1521SA	GE2521
Bandwidth	17/150 MHz		25/250 MHz
Attenuation	1x/10x		
Input Impedance	1/10 MΩ		
Input Capacitance	45/12 pF		
Output Impedance	1 MΩ		
Risetime	20/2.3 ns		14/1.4 ns
IEC Rating	300 V CAT II		
Compensation	10–30 pF		
Cable Length	1.2 m		
Readout Actuator	No		
Insulated BNC	No	Yes	No

Kit Contains	
Sprung Hook	1
GND Lead w/Alligator Clip	1
BNC Adapter	1
Replacement Tip	1
Probe Tip Ground	1
Trimmer Tool	1
IC Tip Insulator	1
Tip Insulator	1
Identifier Rings	1



## Passive Voltage, 5mm ELDITEST GE Series

The GE family includes a unique offering of high voltage passive probes at 2,000 and 4,000 volts. Higher than most 100x probes, selected units offer accuracies of 0.5 ppm/V or 1%.

- Bandwidths to 200 MHz
- Low input capacitances
- High accuracy models
- IEC 61010-031 rated
- Full accessories included
- RoHS (2011/65/EU) compliant



### Fixed - 2,000 V Rated

Model	GE3125	GE3121	GE3225	GE3231
Bandwidth	150 MHz		200 MHz	
Attenuation	100x			
Input Impedance	100 MΩ			
Input Capacitance	5 pf			
Output Impedance	1 MΩ			
Risetime	2.3 ns		1.8 ns	
IEC Rating	2,000 V CAT 0			
Compensation	10–30 pF			
Cable Length	1.2 m			
Readout Actuator	No			
Voltage Coefficient (VCR)	0.5 ppm/V (1%)	≤30 ppm/V (6%)	0.5 ppm/V (1%)	≤30 ppm/V (6%)

Accessory	Kit Contains			
Sprung Hook	1	1	1	1
GND Lead w/Alligator Clip	1	1	1	1
HV Replacement Tip	1	1	1	1
Trimmer Tool	1	1	1	1
IC Tip Insulator	1	1	1	1
Identifier Rings	1	1	1	1

### Fixed - 4,000 V Rated

Model	GE3425	GE3421
Bandwidth	100 MHz	
Attenuation	100x	
Input Impedance	100 MΩ	
Input Capacitance	5 pf	
Output Impedance	1 MΩ	
Risetime	3.5 ns	
IEC Rating	4,000 V CAT 0	
Compensation	10–30 pF	
Cable Length	1.2 m	
Readout Actuator	No	
Voltage Coefficient (VCR)	0.5 ppm/V (1%)	≤30 ppm/V (6%)

Each Kit Contains	
Sprung Hook	1
GND Lead w/Alligator Clip	1
HV Replacement Tip	1
Trimmer Tool	1
IC Tip Insulator	1
Identifier Rings	1



# Oscilloscope Probes

## Passive & Accessories

### 5mm Oscilloscope Probe Accessories

• RoHS (2011/65/EU) compliant.



#### BNC Adapter

Model	CT2708
-------	--------

Non-terminated.  
Sold in package of 10.



#### Sprung Hooks

Model	CT2709A
-------	---------

Snap locking feature holds hook firmly to probe. Package of 10.

Model	Color
CT2709A-0	Black
CT2709A-2	Red
CT2709A-8	Grey



#### Alligator Clip Ground Leads

Model	CT2710-12-#
-------	-------------

Voltage: 300 V; Length: 12 cm.  
Sold in package of 10.

Model	Color
CT2710-12-0	Black
CT2710-12-8	Grey



#### Replacement Tips

Model	CT2711A-#
-------	-----------

Threaded. Sold in package of 10.

Model	Color
CT2711A-0	Black
CT2711A-8	Grey



#### Tip Insulators

Model	CT2712A-#
-------	-----------

This cover is compatible with most 5 mm scope probes.  
Sold in package of 10.

Model	Color
CT2712A-0	Black
CT2712A-8	Grey



#### IC Lead Tip Insulators

Model	CT2713A-#
-------	-----------

Sold in package of 10.

Model	Color
CT2713A-0	Black
CT2713A-8	Grey



#### Tip Ground

Model	CT2714
-------	--------

Moves ground point close to the tip for best signal.  
Sold in package of 10.



#### Trimmer Tool

Model	CT2715
-------	--------

Sold in package of 10.



#### Accessory Kit

Model	CT2838A
-------	---------

9-piece kit. Excellent for getting started; also as replacement for worn or lost original devices.

##### Kit includes:

(1) BNC Adaptor	(1) Sprung Hook
(1) Replacement Tip	(1) Tip Insulator
(1) IC Lead Tip Insulator	(1) Tip Ground
(1) Trimmer Tool	(2) Identifier Rings



#### Tip Ground Kit

Model	CT3668
-------	--------

4-piece kit. Gold plated.

##### Kit includes:

(1) Probe Tip Ground, 2.5 mm (0.1") Reach
(1) Probe Tip Ground, 5 mm (0.2") Reach
(1) Probe Tip Ground, 7.5 mm (0.3") Reach
(1) Probe Tip Ground, 10 mm (0.4") Reach
RoHS (2011/65/EU) compliant
Sold in package of 1



### 5mm Oscilloscope Probe Accessories (continued)



#### Ground Lead

Model	CT3669-15-8
-------	-------------

Ground lead for 5 mm probes with 0.6 mm pin jack, 15 cm (6") Grey (Gold C-Clip).  
Sold in package of 10.

Model	Color
CT3669-15-8	Grey



#### Twin lead Adapter

Model	CT3679
-------	--------

Twin lead adapter with two SMT test clips. Use with cover shell.  
Sold in package of 1.



#### Deluxe Trimmer Tool

Model	CT3648
-------	--------

Sold in package of 10.



#### Identifier Rings

Model	CT3662
-------	--------

Probe marking clips, 10 pieces (5 colors x 2 each).  
Sold in package of 10.



#### High Voltage Replacement Tip

Model	CT3823-0
-------	----------

For 2 kV and 4 kV Elditest 5 mm scope probes. Threaded.  
Sold in package of 10.

Model	Color
CT3823-0	Black

# Oscilloscope Probes

## Current



CP6990-NA  
CP6990-EU

**New**

### AC/DC Clamp-On Current Probes ELDITEST Brand

ELDITEST current probes extend the functionality of general purpose oscilloscopes. These active probes feature dual-range selection, over-range indicator, and battery power (battery not included) for portable applications. The included power adapter is available for either North American (120 V 60 Hz) or European (230 V 50 Hz) mains.

- Kits include:
  - (1) Current probe
  - (1) Insulated BNC cable
  - (1) BNC to banana plug adapter
  - (1) AC adapter
  - (1) User manual

- Current ranges: 40, 50, 70 & 100 A
- Bandwidths 300 kHz, 500 kHz, 1 MHz & 1.5 MHz
- Dual sensitivity ranges
- Over-range indicator
- Adapter (included) or battery powered
- Full accessories included
- RoHS (2011/65/EU) compliant

*Model	CP6220-NA CP6220-EU	CP6550-NA CP6550-EU	CP6770-NA CP6770-EU	CP6990-NA CP6990-EU
Measurement Ranges	100 mV/A / 10 mV/A	200 mV/A / 20 mV/A	500 mV/A / 50 mV/A	1 V/A / 100 mV/A
Current (DC + peak AC)	10 A / 100 A	5 A / 50 A	7 A / 70 A	4 A / 40 A
DC Measurement Accuracy	±3% ±50 mA @ 100 mV/A (50 mA to 10 A peak) ±4% ±50 mA @ 10 mV/A (500 mA to 40 A peak) ±15% max @ 10 mV/A (40 A peak to 100 A peak)	±3% ±30 mA @ 200 mV/A (30 mA to 5 A peak) ±4% ±300 mA @ 20 mV/A (300 mA to 20 A peak) ±15% max @ 200 mV/A (20 A peak to 50 A peak)	±3% ±20 mA @ 500 mV/A (20 mA to 14 A peak) ±4% ±200 mA @ 50 mV/A (200 mA to 100 A peak) ±15% max @ 50 mV/A (100 A peak to 140 A peak)	±3% ±10 mA @ 1 V/A (10 mA to 8 A peak) ±4% ±100 mA @ 100 mV/A (100 mA to 80 A peak)
Bandwidth	DC - 300 kHz	DC - 500 kHz	DC - 1 MHz	DC - 1.5 MHz
Rise and Fall Time	1.2 µs (typ.)	0.7 µs (typ.)	0.35 µs (typ.)	0.23 µs (typ.)
Max Working/ Floating Voltage	600 VAC RMS CAT II 300 VAC RMS CAT III			
Battery Life	8 hours		6 hours	4 hours
Max Cable Diameter	11 mm (.43")		10.3 mm (.40")	
Dimensions	262 x 79 x 36 mm (10.3" x 3.15" x 1.4")		262 x 81 x 36 mm (10.3" x 3.2" x 1.4")	
Weight	260 g w/o battery		310 g w/o battery	

\* Suffix for Power Adapter: – NA North American style plugs  
– EU European style plugs

### AC/DC Current Probe Accessories

Can be used with Elditest clamp-on current probe models:  
 CP6220-NA, CP6550-NA, CP6770-NA, CP6990-NA  
 CP6220-EU, CP6550-EU, CP6770-EU, CP6990-EU

#### BNC to Banana Plug Adapter



Model	CT3956
-------	--------

Model CT3956 is an insulated BNC female to sheath banana plug adapter. Sold in package of 5.

**Features:**

- Voltage Max: 500 Vrms
- Current Max: 3 A
- Impedance: 50 Ω
- Temperature: 0° to +50° C
- RoHS (2011/65/EU) compliant

#### BNC to BNC Coaxial Cable



Model	CT3955-100
-------	------------

Model CT3955 is a high quality BNC male to male coaxial insulated cable assembly. Molded bend relief boot. Sold in package of 5.

**Features:**

- Connector Grade: general purpose
- Impedance: 50 Ω
- Frequency range: DC to 1 GHz
- VSWR Max: 1.2:1 - DC to 1 GHz
- Cable Type: RG-58C/U
- Length: 100 cm
- RoHS (2011/65/EU) compliant

Model	CT3957-NA	CT3957-EU
Mains Plug Style	North American	European
Input Power	120 VAC 60 Hz	230 VAC 50 Hz
Output Power	9 VDC 300 mA	
Output Plug	2.1 mm x 5.5 mm, Center Pin Negative	
UL Listed	Yes	
Use with Models	CP6220-NA; CP6550-NA; CP6770-NA; CP6990-NA; CT4068-NA; CT4076-NA; CT4078-NA; CT4079-NA	CP6220-EU; CP6550-EU; CP6770-EU; CP6990-EU; CT4068-EU; CT4076-EU; CT4078-EU; CT4079-EU



CT3957-NA

#### Power Adapters for AC/DC Current Probes

- RoHS (2011/65/EU) compliant



## Digital Multimeter Probes

Cal Test Electronics offers one of the most extensive lines of DMM probes. In this section you will find the most widely used probes with leads, probe bodies, fused probes, plus the accessories for all your testing needs.

Probes with Leads .....	25-26
RF & High Voltage Probes.....	26
Probe Bodies .....	27-28
Probe Accessories.....	29
3900 Series Probes .....	30-31
Fused Probes .....	32-33



# Digital Multimeter Probes

## Probes with Leads



CT2789A



CT2900A



CT3985-120



CT3986-120

## DMM Probes with Leads Right-Angle Connector

Probes feature 4 mm right-angle sheath banana plug connectors, usable with all major brands of digital multimeters.

- IEC 61010-031 rated
- PVC & silicone lead wires
- RoHS (2011/65/EU) compliant
- See page 30 for additional CT3900 series tip accessories



CT3984-120-0

Model	CT2789A	CT2900A	CT3986-120	CT3985-120	CT3984-120-#
Type	Set				Individual
Tip Diameter x Length	2 mm (.080") x 19 mm (.75")				
Connector	Right Angle, 4 mm Sheath, Banana Plug				
IEC Rating	1,000 V CAT III	1,000 V CAT III / 600 V CAT IV w/cap (CAT II w/o cap)			
Current Max	12 A		10 A		
Jacket Material	PVC		Silicone		
Wire Gauge, AWG	18				
Stranding (# x Diam.)	195 x 0.07 mm				
Cable OD, mm (in)	3.7 mm (.146")				
Cable Length	100 cm		120 cm		
Color	Black & Red				See How to Order
Quantity / Pkg	1 Pair				10
Listed	UL		--	--	--
Accessory	--	Alligator Clips 1,000 V CAT III	Spring Hooks w/Snap Lock 300 V CAT II	--	--

How to Order	Color (-#)	
CT3984-120-#	-0 Black	-2 Red

# Digital Multimeter Probes

## Probes with Leads and RF & High Voltage



CT3981-120



CT3980-120-0



CT3982-120

Model	CT3982-120	CT3981-120	CT3980-120-#
Type	Set		Individual
Tip Diameter x Length	2 mm (.080") x 19 mm (.75")		
Connector	Straight, 4 mm Sheath, Banana Plug		
IEC Rating	1,000 V CAT III / 600 V CAT IV w/cap, (CAT II w/o cap)		
Current Max	10 A		
Jacket Material	Silicone		
Wire Gauge, AWG	18		
Stranding (# x Diam.)	168 x 0.07 mm		
Cable OD, mm (in) x Length	3.7 mm (.146") x 120 cm		
Color	Black & Red		See How to Order
Quantity / Pkg	1 Pair		10
Accessory	Sprung Hooks w/Snap Lock 300 V CAT II	--	--

## DMM Probes with Leads Straight Connector

Probes feature 4 mm straight sheath banana plug connectors, usable with all major brands of digital multimeters.

- IEC 61010-031 rated
- Silicone lead wires
- RoHS (2011/65/EU) compliant
- See page 30 for additional CT3900 series tip accessories

How to Order	Color (-#)	
CT3980-120-#	-0 Black	-2 Red



## 900 MHz RF DMM Probe

This probe allows a DMM to measure sine-wave AC signals up to 900 MHz with an accuracy of  $\pm 2.0$  dB. Slim styled body for easy handling. Output is through 4 mm sheath banana plugs.

- Conversion factor: 1 Veff = 1 VDC on meter
- Accessory kit included
- RoHS (2011/65/EU) compliant

Model	CT2666A
Bandwidth	100 kHz-900 MHz
Input Capacitance	8 pF
Voltage Max	100 V
Accuracy	$\pm 2.0$ dB
Max HF Voltage	30 V
Actuation Voltage	0.35 V



## 40 kV High Voltage DMM Probe

The CT2700 High Voltage DMM Probe allows a standard DMM to measure voltages up to 40 kV or 28 kV AC. With a divider ratio of 1,000:1. Output is through 4 mm sheath banana plugs.

- Meets IEC 61010-031 rated: CAT II P2
- RoHS (2011/65/EU) compliant

Model	CT2700
Input Impedance	1 k $\Omega$
Voltage Max	40 kV / 28 kV
Accuracy	$\pm 2$ % (+1 % to 20 kV AC)
Temp. Coeff., ppm/deg C	200 ppm/deg C
Meter Impedance	10 M $\Omega$ Min.

# Digital Multimeter Probes

## Probe Bodies



### DMM 4mm Banana Plug Probe Bodies

General purpose test probe bodies with 4 mm banana plug contacts on tips. Model CT2268 features exchangeable 2 mm tips.

- IEC 61010-031 rated
- Connector 4 mm banana jack
- RoHS (2011/65/EU) compliant

Model	CT2483	CT2265-#	CT3776	CT3775-#	CT2268
Type	Set	Individual	Set	Individual	Set
Tip Type	4 mm Banana				4 mm Banana / 2 mm Smooth
IEC Rating	1,000 V CAT III w/cap, (CAT II w/o cap)		1,000 V CAT II		1,000 V CAT III w/cap, (CAT II w/o cap)
Current Max	36 A		10 A		36 A
Body Style	Standard		Compact		Standard
Body Length	3.8" (96 mm)		2.9" (74 mm)		3.8" (96 mm)
Color	Black & Red	See How to Order	Black & Red	See How to Order	Black & Red
Quantity / Pkg	1 Pair	10	1 Pair	10	1 Pair

How to Order	Color (-#)	
CT2265-#	-0 Black	-2 Red
CT3775-#	-0 Black	-2 Red

Model	CT2664	CT2576-#
Type	Set	Individual
Hooks to Wires	Up to .140" Diameter	
Connector	Fits Probe with 4 mm Banana Plug	
IEC Rating	30 VAC / 60 VDC	
Current Max	5 A	
Color	Black & Red	See How to Order
Quantity / Package	1 pair	10

How to Order	Color (-#)	
CT2576-#	-0 Black	-2 Red

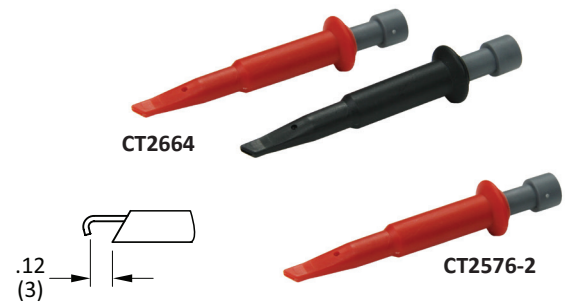

### Sprung Hooks

Intended for probes with 4 mm banana plug contacts. Adds the convenience of hook connection to your probes.

- IEC 61010-031 rated
- RoHS (2011/65/EU) compliant

# Digital Multimeter Probes

## Probe Bodies



## DMM Fine & Extra Fine Tip Probe Bodies

Models CT2662 / CT2264-# are our highest category rated probes; 1,000 V CAT IV. Models CT2662 / CT2388-# feature spring-loaded tips for fine contact probing.

- IEC 61010-031 rated
- Connector is 4 mm banana jack
- Probes come with clear, removable IC Cap
- RoHS (2011/65/EU) compliant



Model	CT2662	CT2264-#	CT2665	CT2388-#
Type	Set	Individual	Set	Individual
Tip Style	Fine		Extra Fine, Spring-Loaded	
Body Style (Size)	Slim Line		Miniature	
IEC Rating	1,000 V CAT IV		600 V CAT II	
Current Max	16 A		1 A	
Body Length	5.4" (136 mm)		3.2" (81 mm)	
Color	Black & Red	See How to Order	Black & Red	See How to Order
Quantity / Pkg	1 Pair	10	1 Pair	10

How to Order	Color (-#)	
CT2264-#	-0 Black	-2 Red
CT2388-#	-0 Black	-2 Red

## DMM 2mm Probe Bodies

General purpose test probe bodies with 2 mm (.080") diameter pin tips

- IEC 61010-031 rated
- Connector is 4 mm banana jack
- Tip fits North American blade contact power sockets
- RoHS (2011/65/EU) compliant



Model	CT2988	CT2266-#
Type	Set	Individual
Tip Diameter x Length	2 mm (.080") x 19 mm (.75")	
IEC Rating	1,000 V CAT II	
Current Max	36 A	
Body Style (Size)	Standard	
Body Length	3.8" (96 mm)	
Color	Black & Red	See How to Order
Quantity / Pkg	1 Pair	10

How to Order	Color (-#)	
CT2266-#	-0 Black	-2 Red







### Spade Lugs, Splices & Banana Plug Adapters

- IEC 61010-031 rated
- RoHS (2011/65/EU) compliant

Model	CT2661	CT2553-#	CT2663	CT2248-#	CT3089	CT2473-#
Type	Set	Individual	Set	Individual	Set	Individual
Adapter	Spade Lug Adapter		Insulated Splice		Banana Plug Adapter	
Connector	6/4 mm Lug to 4 mm Sheath Banana Jack		4 mm Sheath Banana Jack to 4 mm Sheath Banana Jack		4 mm Banana Plug to 4 mm Sheath Banana Jack	
Accepts	Accepts 4 mm Sheath Banana Plug		Accepts Two 4 mm Sheath Banana Plug		Accepts 4 mm Sheath Banana Plug	
IEC Rating	30 VAC / 60 VDC		1,000 V CAT III		30 VAC / 60 VDC	
Current Max	36 A				10 A	
Color	Black & Red	See How to Order	Black & Red	See How to Order	Black & Red	See How to Order
Quantity / Package	1 pair	10	1 pair	10	1 pair	10

How to Order	Color (-#)					
CT2553-#	-0 Black	-2 Red	-4 Yellow	-5 Green	-6 Blue	-9 White
CT2248-#	-0 Black	-2 Red	--	--	--	--
CT2473-#	-0 Black	-2 Red	-4 Yellow	-5 Green	-6 Blue	-9 White



### Tri-Fold Accessory Pouch

Model	CT3041
-------	--------

- Size:  
7"W x 5"H closed  
7"W x 16"H open
- 3 hook & loop locked 6"W x 3"H pockets w/clear viewing panel.
- Nylon, black

# Digital Multimeter Probes

## 3900 Series Probes & Tip Accessories



### DMM 2mm Probe Bodies

Cal Test's CT3900 series DMM probes provides performance and safety with a unique selection of tip adapters. Each adapter snap-locks to the probe for secure and safe usage, which extends the utility of the probe.

- IEC 61010-031 rated
- Connector is 4 mm banana jack
- Tip fits North American blade contact power sockets
- RoHS (2011/65/EU) compliant

Model	CT3975	CT3974-#
Type	Set	Individual
Tip Diameter x Length	2 mm (.080") x 19 mm (.75")	
IEC Rating	1,000 V CAT III / 600 V CAT IV w/cap, (CAT II w/o cap)	
Current Max	10 A	
Body Length	2.96" (75 mm)	
Color	Black & Red	See How to Order
Quantity / Pkg	1 Pair	10

### Extended Tip Probe Adapters

- Snap-locks to probe bodies
- 4.25" stainless steel tip
- Clear Kynar® sleeve insulation
- RoHS (2011/65/EU) compliant

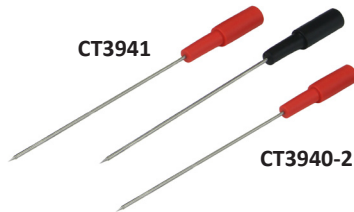

Model	CT3941	CT3940-#
Type	Set	Individual
Voltage	300 V CAT II	
Current	3 A	
Color	Black & Red	See How to Order
Qty / Pkg	1 Pair	5

How to Order	Color (-#)	
CT3940-#	-0 Black	-2 Red

### Sprung Hook Probe Adapters

- Snap-locks to probe bodies
- Hooks onto wires and terminals
- Brass, nickel plated
- RoHS (2011/65/EU) compliant

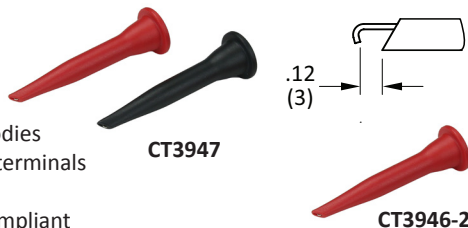

Model	CT3947	CT3946-#
Type	Set	Individual
Voltage	300 V CAT II	
Current	3 A	
Color	Black & Red	See How to Order
Qty / Pkg	1 Pair	5

How to Order	Color (-#)	
CT3946-#	-0 Black	-2 Red

### Alligator Clip Probe Adapters

- Snap-locks to probe bodies
- Standard alligator clip, steel, nickel plated
- Flexible insulating rubber boot
- RoHS (2011/65/EU) compliant



Model	CT3943	CT3942-#
Type	Set	Individual
Voltage	300 V CAT II	
Current	5 A	
Color	Black & Red	See How to Order
Qty / Pkg	1 Pair	5

How to Order	Color (-#)	
CT3942-#	-0 Black	-2 Red

### Spade Lug Probe Adapters

- Snap-locks to probe bodies
- Spade lug for #6 & #4 studs
- Brass, nickel plated
- RoHS (2011/65/EU) compliant



Model	CT3945	CT3944-#
Type	Set	Individual
Voltage	<30 VAC / <60 VDC	
Current	5 A	
Color	Black & Red	See How to Order
Qty / Pkg	1 Pair	5

How to Order	Color (-#)	
CT3944-#	-0 Black	-2 Red

## 3900 Series Probes & Tip Accessories

### Complete Kit of Probe Adapter Pairs

**Model** CT3948

- Snap-locks to probe bodies
- 4 styles of adapters
- Convenient black and red pairs
- Packaged in polybag
- RoHS (2011/65/EU) compliant



Kit Contains	
(2) Extended Tips, (1) Black, (1) Red - (CT3941)	
(2) Alligator Clips, (1) Black, (1) Red - (CT3943)	
(2) Spade Lugs, (1) Black, (1) Red - (CT3945)	
(2) Sprung Hooks, (1) Black, (1) Red - (CT3947)	
Rating	
<b>Extended Tips</b>	300 V CAT II, 3 A
<b>Alligator Clips</b>	300 V CAT II, 5 A
<b>Spade Lugs</b>	<30 VAC / <60 VDC, 5 A
<b>Sprung Hooks</b>	300 V CAT II, 3 A

### Probe Bodies with Fixed Tip and Safety Cap + Accessory Adapters

**Model** CT3978

- Probe bodies accept 4 mm sheath banana plugs
- Cap on probe tip provides CAT III / CAT IV rating
- Standard 2 mm x 19 mm probe tips
- All accessories snap-lock to probe bodies
- Convenient black and red pairs
- RoHS (2011/65/EU) compliant

Kit Contains	
(2) Probe Bodies, (1) Black, (1) Red - (CT3975)	
(2) Sprung Hooks, (1) Black, (1) Red - (CT3947)	
(2) Alligator Clips, (1) Black, (1) Red - (CT3943)	
(2) Spade Lugs, (1) Black, (1) Red - (CT3945)	
(2) Extended Tips, (1) Black, (1) Red - (CT3941)	
Rating	
<b>Probe Bodies</b>	1,000 V CAT III / 600 V CAT IV w/cap, (CAT II w/o), 10 A
<b>Sprung Hooks</b>	300 V CAT II, 3 A
<b>Alligator Clips</b>	300 V CAT II, 5 A
<b>Spade Lugs</b>	<30 VAC / <60 VDC, 5 A
<b>Extended Tips</b>	300 V CAT II, 3 A

### Probe Bodies with Fixed Tip with Safety Cap + Spring Hooks

**Model** CT3976

- Standard 2 mm x 19 mm probe tips
- Sprung hooks snap-lock to probe bodies
- Probe bodies accept 4 mm sheath banana plugs
- Cap on probe tip provides CAT III / CAT IV rating
- Convenient black and red pairs
- RoHS (2011/65/EU) compliant

Kit Contains	
(2) Probe Bodies, (1) Black, (1) Red - (CT3975)	
(2) Sprung Hooks, (1) Black, (1) Red - (CT3947)	
Rating	
<b>Probe Bodies</b>	1,000 V CAT III / 600 V CAT IV w/cap, (CAT II w/o), 10 A
<b>Sprung Hooks</b>	300 V CAT II, 3 A



### Probe Safety Cap

**Model** CT3994-8

- Safety cap snap-locks to probe body
- Allows probes to meet latest safety standards
- Color: grey
- Sold 25/pkg.
- RoHS (2011/65/EU) compliant



# Digital Multimeter Probes

## Fused Probes

**New**

### Fused Probes ELDITEST Brand

The CT399x series fused probes enhance user safety when working in high energy CAT III and CAT IV environments. The replaceable fuse provides fast interrupt in fault conditions. The probes feature a 1 MΩ resistor in parallel with the fuse. Although it is recommended to check for a blown fuse before and after the measurement, if the probe is used with a blown fuse, the parallel resistor will provide a 90% accurate measurement thereby avoiding a “zero” instrument reading when there is a hazardous voltage present.

- IEC 61010-031 rated
- Replaceable 1,000 VAC / VDC, 11 A, 20 kA IR fast-acting fuse
- 1,000 V CAT III / 600 V CAT IV IEC voltage rating w/protective cap
- 4 mm banana plug tip, removable for a 2 mm pin tip for both CT3997 and CT3999
- Special circuit to prevent hazardous “zero” reading in blown fuse situation
- RoHS (2011/65/EU) compliant



CT3999



CT3997-2



4 mm plug removeable  
for 2 mm pin tip

Model	CT3999	CT3997-#
Description	Probe Set	Probe Body
Type	Set	Individual
Probe Tip Diameter	4 mm Banana Plug Spring Tip; Removable for 2 mm (.080")	
Connector	Right-Angle Sheath 4 mm Banana Plug	4 mm Banana Jack
IEC Rating	1,000 V CAT III / 600 V CAT IV w/ Protective Cap	
Current Max	11 A	
Interrupting Rating	20 kA	
Replacement Fuse	CT3998-11A (Fast Acting)	
Jacket Material	Silicone	N/A
Wire Gauge, AWG	18	N/A
Stranding (# x Diam.)	168 x 0.07 mm	N/A
Cable OD, mm (in)	3.7 mm (.146")	N/A
Cable Length	150 cm	N/A
Color	Black & Red	See How to Order
Quantity / Pkg	1 Pair	1

How to Order	Color (-#)	
CT3997-#	-0 Black	-2 Red

**New**

### Replacement Fuses for Fused Probes

- 10 x 38 mm
- For fused probes shown above
- Fast acting ceramic
- RoHS (2011/65/EU) compliant



Model	CT3998-11A
Voltage Max	1,000 V
Current Max	11 A
Interrupting Rating	20 kA
Approvals	UL / CSA
Quantity / Pkg	2



## Fused Probes

### DMM Fused Probe Bodies Banana Plug Tip with Spring-Loaded Sheath + Safety Cap

Fused probe bodies enhance user safety when working in high energy CAT III and CAT IV environments. The replaceable fuse provides fast interrupt in fault conditions. The probe bodies feature a replaceable 6 x 32 mm fast-acting ceramic fuse in three current ranges. Tips have 4 mm banana plug contacts with a protective spring-loaded sleeve for a CAT II rating, plus an additional protective cap providing CAT III and IV rating. The probe bodies (4.5" 115 mm long) are available individually or in black and red pairs.

- IEC 61010-031 rated
- Replaceable fast-acting ceramic fuses
- 1,000 V CAT III / 600 V CAT IV IEC voltage rating w/protective cap
- 4 mm banana plug tip with spring-loaded sleeve
- Connector: sheath 4 mm banana jack
- RoHS (2011/65/EU) compliant



Model	CT3146	CT3145-#	CT3210	CT3209-#	CT3212	CT3211-#
Type	Set	Individual	Set	Individual	Set	Individual
IEC Rating	1,000 V CAT III w/cap, (CAT II w/o cap)					
Voltage (fuse)	600 V		660 V		1,000 V	
Current Max (fuse)	10 A		500 mA			
Interrupting Rating (fuse)	50 kA		30 kA		50 kA	
Replacement Fuse	CT3194		CT3195		CT3196	
Color	Black & Red	See How to Order	Black & Red	See How to Order	Black & Red	See How to Order
Quantity / Pkg	1 Pair	5	1 Pair	5	1 Pair	5

How to Order	Color (-#)	
CT3145-#	-0 Black	-2 Red
CT3209-#	-0 Black	-2 Red
CT3211-#	-0 Black	-2 Red

Model	CT3194	CT3195	CT3196
Voltage Max	600 V	660 V	1,000 V
Current Max	10 A	500 mA	
Interrupting Rating	50 kA	30 kA	50 kA
Quantity / Pkg	10		

### Replacement Fuses

- 6 x 32 mm
- For fused probes shown above
- Fast acting ceramic
- UL / CSA approved
- RoHS (2011/65/EU) compliant



Model	CT3208	CT3189-#	CT3408	CT3407-#
Type	Set	Individual	Set	Individual
Size	Large		Extra-Large	
IEC Rating	1,000 V CAT III			
Current Max	20 A		36 A	
Resistance Max	20 mΩ			
Color	Black & Red	See How to Order	Black & Red	See How to Order
Qty / Package	1 Pair	5	1 Pair	5

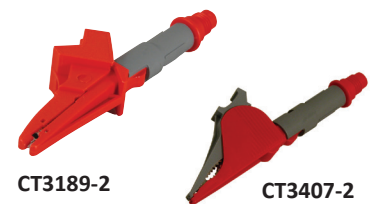

### Alligator Clips for Fused Probes, Insulated

- IEC 61010-031 rated
- With thread for assembly to fused probe bodies
- RoHS (2011/65/EU) compliant

How to Order	Color (-#)	
CT3189-#	-0 Black	-2 Red
CT3407-#	-0 Black	-2 Red



## Clips

A complete offering of the most popular electrical and electronic test clips including alligator, miniature alligator, spring (crocodile), plier type, telecom, and Kelvin. This section also includes SMD test clips, MicroClips, MiniFlex, MiniPro and SMD tweezers.

Product tables include cross reference to \*Mueller clips.

Alligator .....	35-39
Spring (Crocodile) .....	40
Plier Type .....	40
Telecom .....	41
Kelvin .....	41
SMD Clips .....	42-46
SMD Tweezers .....	45

\* Mueller is the registered trademark of Mueller Electric Co.



CTM-34



CTM-30



CTM-30BL



CTM-30TBO



CTM-60CS



CTM-60U



CTM-60TBO

### Uninsulated

• RoHS (2011/65/EU) compliant

Model	CTM-34	CTM-34C	CTM-30	CTM-30C	CTM-30BL	CTM-30TBO	CTM-60CS	CTM-60S	CTM-60U	CTM-60TBO	CTM-60	CTM-60C	CTM-60X
Size	Micro		Miniature				Standard						
Max Jaw Opening	.22" (5.6 mm)		.188" (4.8 mm)				.31" (7.9 mm)						
Length	1.1" (28 mm)				1.25" (32 mm)	1.5" (39 mm)	1.97" (50 mm)			2.13" (54 mm)	2.23" (57 mm)		
Current Max	5 A						10 A						
Material	Steel, Zinc Plt.	Solid Copper	Steel, Zinc Plt.	Solid Copper	Steel, Zinc Plt.		Solid Copper	Steel, Zinc Plt.			Solid Copper	Stainless Steel	
Barrel	None				1/8" ID	Internally Threaded	4 mm Accepts Std. Banana Plug	None		Internally Threaded	4 mm Accepts Std. Banana Plug		
Connection	Solder or Crimp		Solder			6-32 UNC	Solder or Crimp Plus Screw		Crimp Slot	6-32 UNC	Solder or Crimp		
Mueller Cross	BU-34	BU-34C	BU-30	BU-30C	BU-30BL	BU-30TBO	BU-60CS	BU-60S	BU-60U	BU-60TBO	BU-60	BU-60C	BU-60X
Use Insul. Boot	CTM-36		CTM-32		CTM-31		CTM-62						
Qty / Pkg	100												50

### Insulating Boots

• RoHS (2011/65/EU) compliant



Model	Length	Material	Color	Fit these Clips	Mueller Cross	Quantity / Package
CTM-62-#	2.03" (52 mm)	PVC	See How to Order	CTM-60, -60C, -60CS, -60PR2, -60S, -60TBO, -60U, and -60X	BU-62-*	100

How to order	Colors (-#)					
CTM-62-#	-0 Black	-2 Red	-4 Yellow	-5 Green	-6 Blue	-9 White

## Alligator

Model	CTM-63-#	CTM-63C-#
Max Jaw Opening	.31" (7.9 mm)	
Length	2.23" (57 mm)	
Current Max	10 A	
Material	Steel, Nickel Plt.	Solid Copper
Insulation	2-Piece Flex. PVC	
Mueller Cross	BU-63-*	BU-63C-*
Color	How to Order	
Qty / Pkg	100	



### Insulated

- Accept 4 mm banana plug
- RoHS (2011/65/EU) compliant

How to Order	Color (-#)					
CTM-63-#	-0 Black	-2 Red	--	--	--	--
CTM-63C-#	-0 Black	-2 Red	-4 Yellow	-5 Green	-6 Blue	-9 White

CT3810-60



CT3809-60-2



CT2394

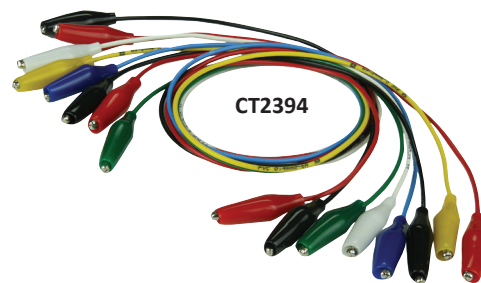

## Test Leads

- IEC 61010-031 rated
- Test leads feature an alligator clip at each end
- RoHS (2011/65/EU) compliant

Model	CT3810-L	CT3809-L-#	CT2394
Type	Set	Individual	Kit
Both Ends	Insulated Alligator Clip		
Alligator Jaws Open to	.31" (7.9 mm)		
Alligator Clip	Steel, Nickel Plt.		
Boot	PVC		
IEC Rating	300 V CAT II		30 VAC / 60 VDC
Current Max	10 A		5 A
Jacket Material	Silicone		PVC
Wire Gauge	18 AWG		21 AWG
Stranding (# x Diam.)	168 x 0.07 mm		104 x 0.07 mm
OD	3.7 mm (.146")		2.0 mm (.079")
Length	See How to Order		50 cm
Color	Black & Red	See How to Order	2 Black, 2 Red, 1 Yellow, 1 Green, 1 Blue, 1 White
Qty / Pkg	1 Pair	10	8-piece Kit

### How to Order

CT3809-L-#	Length cm (-L)		
	-30	-60	-100
CT3810-L	Color (-#)		
	-0 Black	-2 Red	--
CT3810-L	Length cm (-L)		
	-30	-60	-100



### Fully Insulated

- IEC 61010-031 rated
- RoHS (2011/65/EU) compliant

Model	CTM-652-#	CTM-65-#	CT2490A	CT2392A-#	CT3286	CT3251-#	CT3438-#	CT3449	CT3441-#
Connector	4 mm Sheath Banana Jack						8-32 UNC Internal Thread, IP2X Finger Safe		
Type	Individual		Set	Individual	Set	Individual	Individual	Set	Individual
Size	Small	Large			Extra Large		Large	Extra Large	
Max Jaw Opening	.27" (7 mm)	.75" (19 mm)	.96" (25 mm)	1.26" (32 mm)		.96" (25 mm)	1.26" (32 mm)		
Length	3.23" (82 mm)		3.58" (91 mm)		3.62" (92 mm)		3.58" (91 mm)	4.33" (110 mm)	
IEC Rating	1,000 V CAT III / 600 V CAT IV	1,000 V / CAT III	1,000 V CAT III / 600 V CAT IV						
Current Max	20 A	30 A	20 A		36 A		20 A	36 A	
Mueller Cross	BU-652-*	BU-65-*	--	--	--	--	--	--	--
Color	See How to order		Black & Red	See How to order	Black & Red	See How to order	See How to order	Black & Red	See How to order
Qty / Pkg	10		1 Pair	10	1 Pair	10	10	1 Pair	5

How to Order	Color (-#)								
CTM-652-#	-0 Black	--	-2 Red	--	--	--	--	--	--
CTM-65-#	-0 Black	--	-2 Red	--	--	--	--	--	--
CT2392A-#	-0 Black	-1 Brown	-2 Red	-4 Yellow	-5 Green	-6 Blue	--	--	-9 White
CT3251-#	-0 Black	-1 Brown	-2 Red	-4 Yellow	-5 Green	-6 Blue	-8 Grey	-7 Violet	-9 White
CT3438-#	-0 Black	--	-2 Red	--	--	--	--	--	--
CT3441-#	-0 Black	--	-2 Red	--	--	--	--	--	--



# Clips

## Pincer, Hook & Alligator

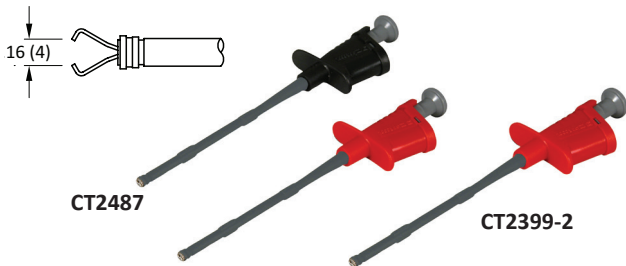

### Pincer Style Clips, Flexible

Pincer can be rotated for easy connection, and flexible shaft is bendable to 90 degrees.

- IEC 61010-031 rated
- Fully insulated
- RoHS (2011/65/EU) compliant

Model	CT2487	CT2399-#
Type	Set	Individual
Interconnect	4 mm Sheath Banana Jack	
IEC Rating	1,000 V CAT II	
Current Max	6 A	
Grasps Terminal Diameter up to	4 mm (.16")	
Body Insulation	Polyamide (Nylon) and Santoprene	
Contacts	Brass, Nickel Plated	
Color	Black & Red	See How to Order
Length	6"	
Quantity / Pkg	1 Pair	10

How to Order	Color (-#)	
CT2399-#	-0 Black	-2 Red

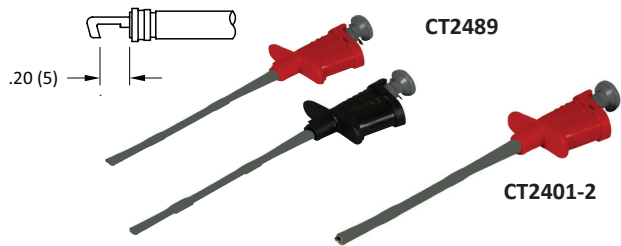

### Hook Style Clips, Flexible

Pincer can be rotated for easy connection, and flexible shaft is bendable to 90 degrees.

- IEC 61010-031 rated
- Fully insulated
- RoHS (2011/65/EU) compliant

Model	CT2489	CT2401-#
Type	Set	Individual
Interconnect	4 mm Sheath Banana Jack	
IEC Rating	1,000 V CAT II	
Current Max	6 A	
Grasps Terminal Diameter up to	5 mm (.20")	
Body Insulation	Polyamide (Nylon) and Santoprene	
Contacts	Brass, Nickel Plated	
Color	Black & Red	See How to Order
Length	6"	
Quantity / Pkg	1 Pair	10

How to Order	Color (-#)	
CT2401-#	-0 Black	-2 Red

## Pincer, Hook & Alligator

Model	CT2488	CT2400-#
Type	Set	Individual
Interconnect	4 mm Sheath Banana Jack	
IEC Rating	1,000 V CAT III	
Current Max	6 A	
Grasps Terminal Diameter up to	12.7 mm (.50")	
Body Insulation	Polyamide (Nylon) and Santoprene	
Contacts	Brass, Nickel Plated	
Color	Black & Red	See How to Order
Length	6"	
Quantity / Pkg	1 Pair	10

How to Order	Color (-#)	
CT2400-#	-0 Black	-2 Red

Model	CT2966	CT2965-#
Type	Set	Individual
Interconnect	4 mm Sheath Banana Jack	
IEC Rating	1,000 V CAT III	
Current Max	20 A	
Grasps Terminal Diameter up to	12.7 mm (.50")	
Body Insulation	Polyamide (Nylon)	
Contacts	Brass, Nickel Plated	
Color	Black & Red	See How to Order
Length	6"	
Quantity / Pkg	1 Pair	5

How to Order	Color (-#)	
CT2965-#	-0 Black	-2 Red

Model	CT3762	CT3761-#	CT3760	CT3759-#	CT3756	CT3755-#
Type	Set	Individual	Set	Individual	Set	Individual
Interconnect	4 mm Banana Jack		2 mm Banana Jack		8-32 UNC Internal Thread	
IEC Rating	300V CAT II, 10 A					
Jaw Opens to	7.9 mm (.31")					
Body Insulation	PVC					
Contacts	Steel, Nickel Plated					
Color	Black & Red	See How to Order	Black & Red	See How to Order	Black & Red	See How to Order
Quantity / Pkg	1 Pair	10	1 Pair	10	1 Pair	10

How to Order	Color (-#)	
CT3761-#	-0 Black	-2 Red
CT3759-#	-0 Black	-2 Red
CT3755-#	-0 Black	-2 Red

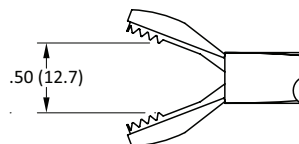

### Alligator Style Clips Flexible

Insulation on alligator contact protects against shorting.

- IEC 61010-031 rated
- Fully insulated
- RoHS (2011/65/EU) compliant

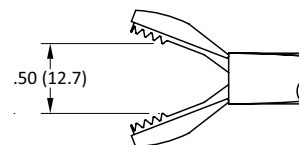
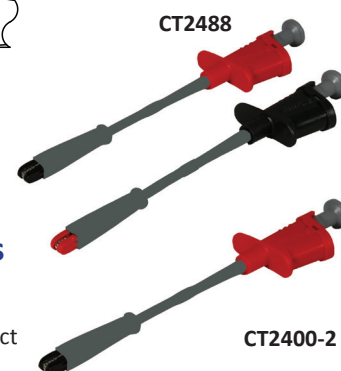

### Alligator Style Clips Rigid

Rigid housing allow increased current capacity. Insulation on jaw contacts protects against shorting.

- IEC 61010-031 rated
- Fully insulated
- Ideal for high current applications
- RoHS (2011/65/EU) compliant



### Alligator Clips Standard Jaw

- IEC 61010-031 rated
- Fully insulated
- Standard jaw
- RoHS (2011/65/EU) compliant

# Clips

## Spring & Plier Type



CTM-27



CTM-25



CTM-21APN



CTM-21CPN

### Spring Clips (Crocodile), Uninsulated Automotive & Heavy Duty

• RoHS (2011/65/EU) compliant

Model	CTM-27	CTM-25	CTM-21APN	CTM-21CPN
Style	Automotive		Heavy Duty	
Type	General Purpose	Teeth on all 3 Sides of Jaw	Shunted	
Max Jaw Opening	.625" (16 mm)	.75" (19 mm)	1.06" (27 mm)	
Length	2.44" (62 mm)	3" (76.2 mm)	4.11" (104 mm)	
Current Max	20 A	40 A	50 A	100 A
Material	Steel, Zinc Plt.			Solid Copper
Marking	None			
Connection	Crimp or Screw			Solder Lug
Mueller Cross	BU-27	BU-25	BU-21APN	BU-21CPN
Use Insul. Boot	CTM-29	CTM-26	CTM-23	
Quantity / Package	50		25	10

## Spring Clip (Crocodile) Insulating Boots

- Material: PVC
- RoHS (2011/65/EU) compliant



CTM-23-2



CTM-26-0



CTM-29-6

Model	Type	Length	Color	Fit these Clips	Mueller Cross	Quantity / Package
CTM-23-#	Heavy Duty	5" (127 mm)	See How to Order	CTM-21A, CTM-21C	BU-23-*	25
CTM-26-#	Automotive	3.88" (98 mm)	See How to Order	CTM-24A, CTM-25, CTM-25C	BU-26-*	50
CTM-29-#	Geophone	3.5" (89 mm)	See How to Order	CTM-27, CTM-27C CTM-27CG, CTM-27CGW	BU-29-*	50

How to Order	Colors (-#)					
CTM-23-#	-0 Black	-2 Red	-4 Yellow	-5 Green	-6 Blue	-9 White
CTM-26-#	-0 Black	-2 Red	--	--	--	--
CTM-29-#	-0 Black	-2 Red	--	--	--	--



## Miniature Plier Type Clips

Plier type clips utilized by the automotive industry for battery chargers, timing lights, jumper cables, and smaller applications.

- Partially insulated
- RoHS (2011/65/EU) compliant

Model	CTM-46A-#
Used For	Battery Work
Max Jaw Opening	1.125" (29 mm)
Length	2.88" (98 mm)
Current Max	50 A
Material	Steel, Copper Plt.
Connection	Solder or Crimp
Mueller Cross	BU-46A-*
Color	See How to Order
Qty / Pkg	50

How to Order	Color (-#)	
CTM-46A-#	-0 Black	-2 Red

Model	Type and Insulation Piercing	Material	Jaws Open up to	Length	Mueller Cross	Qty / Pkg
CTM-8783	Angle Nose w/Bed of Nails and Single Spike	Nickel Silver	1" (25.4 mm)	2.61" (66 mm)	JP-8783	10



### Telecom Clip

- Screw and washer connection included
- RoHS (2011/65/EU) compliant

Model	Length	Material	Color	Fit these Clips*	Mueller Cross	Qty / Pkg
CTM-8681-#	2.4" (61 mm)	PVC	See How to Order	See below	JP-8681-*	100



### Telecom Clip Insulators

- High quality PVC. Durable and flexible.
- RoHS (2011/65/EU) compliant

\* Fits these Clips: CTM-25, CTM-8078, CTM-8099, CTM-8783, CTM-33674 & CTM-33699

How to Order	Color (-#)	
CTM-8681-#	-0 Black	-2 Red

## Kelvin Clips

Kelvin Clips are used to perform four-terminal sensing and are also known as Kelvin sensing. This 4-wire sensing, or 4-point probe method, is an electrical impedance measuring technique that uses separate pairs of current-carrying and voltage-sensing electrodes to make more accurate measurements than traditional two-terminal (2T) sensing. A Kelvin Clip, is often a crocodile clip, that connects a force-and-sense pair when it closes onto a conductor.



### Kelvin Clip with Isolated Jaws

Model	CTM-78K
-------	---------

Metrology grade Kelvin clip features a current path for the source and a circuit path for the sense.

#### Features:

- Material: brass, gold plated
- Jaws open to .50" (12.7 mm)
- Length: 2.28" (58 mm)
- Current max: 10 A
- RoHS (2011/65/EU) compliant
- Mueller cross: BU-78K
- Sold in package of 1



### Small Insulated Kelvin Clip with Isolated Jaws

Model	CTM-75K
-------	---------

#### Features:

- Material: nickel silver, gold tips; nylon
- Jaws open to .31" (7.9 mm)
- Length: 1.625" (41 mm)
- Screw wire connection
- Current max: 10 A
- RoHS (2011/65/EU) compliant
- Mueller cross: BU-75K
- Sold in package of 10

# Clips

## SMD Clips

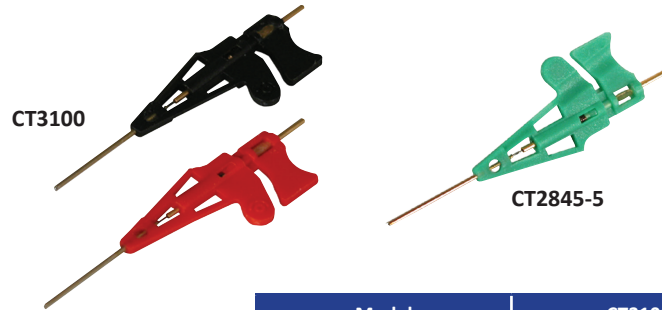
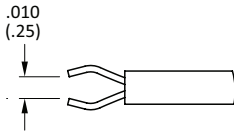

## MicroClip Test Clips

- IEC 61010-031 rated
- Access ICs down to 0.20 mm wide on a 0.45 mm pitch
- Steel pincers open up to .024" (0.6 mm) can be rotated by hand to desired attachment position
- Interconnection pin .031" (0.8 mm)
- Use with MicroLead test leads
- Material: polyamide (Nylon) with stainless steel contacts
- RoHS (2011/65/EU) compliant

Model	CT3100	CT2845-#
Type	Set	Individual
IEC Rating	30 VAC / 60 VDC	
Current Max	0.5 A	
Color	Black & Red	See How to Order
Qty / Pkg	1 Pair	10

How to Order	Color (-#)					
CT2845-#	-0 Black	-2 Red	-4 Yellow	-5 Green	-6 Blue	-9 White

## MicroClip Test Clip Holding Rod

Model	CT2847
-------	--------

- Two-piece holding rod to group MicroTest clips together when stacked side-by-side.
- RoHS (2011/65/EU) compliant



## MicroLead Test Leads

- IEC 61010-031 rated
- Interconnection (pin or jack) .031" (0.8 mm)
- Highly flexible silicone jacketed
- Wire gauge: 24 AWG; OD: 1.4 mm (.055")
- Conductor area: 0.22 mm<sup>2</sup>
- Stranding: 7 x 0.20 mm
- Material: brass, gold plt.
- Length: 10 cm
- RoHS (2011/65/EU) compliant

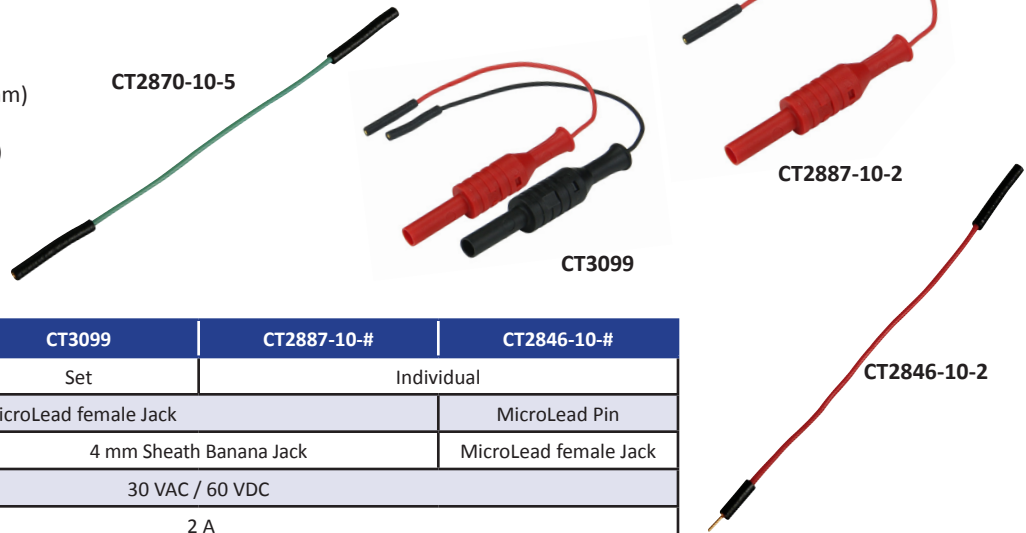

Model	CT2870-10-#	CT3099	CT2887-10-#	CT2846-10-#
Type	Individual	Set	Individual	
One End	MicroLead female Jack			MicroLead Pin
Other End	MicroLead female Jack	4 mm Sheath Banana Jack		MicroLead female Jack
IEC Rating	30 VAC / 60 VDC			
Current Max	2 A			
Color	See How to Order	Black & Red	See How to Order	
Qty / Pkg	10	1 Pair	10	

How to Order	Color (-#)					
CT2870-10-#	-0 Black	-2 Red	--	--	--	--
CT2887-10-#	-0 Black	-2 Red	--	--	--	--
CT2846-10-#	-0 Black	-2 Red	-4 Yellow	-5 Green	-6 Blue	-9 White



CT2848-6



CT2848-8



### MicroClip Test Clip Kits

Kits include SMD MicroTest clips, interconnecting MicroLeads (male to female), holding rods, and come complete with plastic storage box.

- Use MicroLeads to interconnect the MicroTest clips to an instrument
- IEC 61010-031 rated: 30 VAC / 60 VDC
- Current max: 0.5 A
- RoHS (2011/65/EU) compliant

Model	CT2848-6	CT2848-8	CT2848-12
SMD MicroTest Clips	6	8	12
Interconnecting MicroLeads	6	8	12
Holding Rods	3	4	6
Clips and Leads Colors	1 Black, 1 Red, 1 Yellow, 1 Green, 1 Blue & 1 White	2 Black, 2 Red, 1 Yellow, 1 Green, 1 Blue & 1 White	2 Black, 2 Red, 2 Yellow, 2 Green, 2 Blue & 2 White



CT2848-12

### SMD Test Clip

- Pincer style SMD clip or IC test measurements
- Interconnection pins in both finger grips: .024" (0.6 mm)
- Use with .031" (0.8 mm) MicroLead jack
- Nickel plated
- RoHS (2011/65/EU) compliant

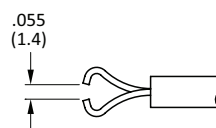

CT3659-8

Model	Voltage	Current	Color	Qty / Pkg
CT3659-8	30 VAC / 60 VDC	1 A	Grey	10

# Clips

## SMD Clips

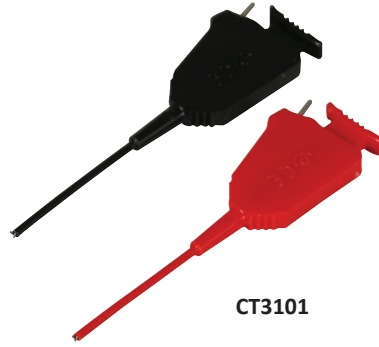
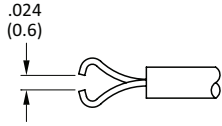

CT3101

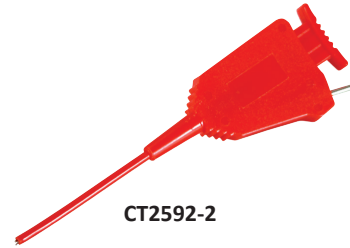

CT2592-2

## SMD MiniFlex Clips

Ideal for surface mount device fine testing. The clip's narrow width, only .12" (3 mm), supports tight side-by-side stacking.

- IEC 61010-031 rated
- Access ICs down to 0.20 mm wide on a 0.8 mm pitch
- Insulated shaft can be flexed up to 36° in any direction
- Steel pincers open up to .024" (0.6 mm) and can be rotated by hand to desired attachment position
- Interconnection pin .031" (0.8 mm)
- Use with MicroLead interconnection wires
- RoHS (2011/65/EU) compliant

Model	CT3101	CT2592-#
Type	Set	Individual
IEC Rating	30 VAC / 60 VDC	
Current Max	1 A	
Color	Black & Red	See How to Order
Qty / Pkg	1 Pair	10

How to Order	Color (-#)	
CT2592-#	-0 Black	-2 Red

## MiniFlex Clip Leads

- IEC 61010-031 rated
- Highly flexible silicone jacketed wire
- Wire gauge: 21 AWG; OD: 2.1 mm (.083")
- Conductor area: 0.40 mm<sup>2</sup>
- Stranding: 100 x 0.07 mm
- RoHS (2011/65/EU) compliant

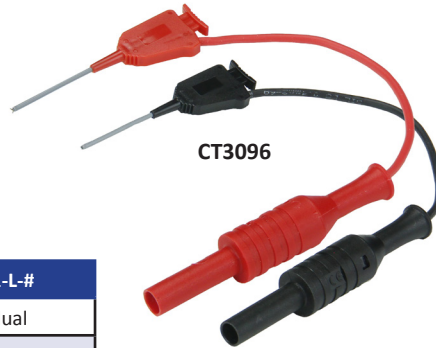

CT3096



CT2551-10-2

Model	CT3096	CT2551-L-#
Type	Set	Individual
One End	MiniFlex Clip	
Other End	4 mm Sheath Banana Jack	
IEC Rating	30 VAC / 60 VDC	
Current Max	1 A	
Length	10 cm	See How to Order
Color	Black & Red	See How to Order
Qty / Pkg	1 Pair	5

How to Order		
CT2551-L-#	Length cm (-L)	
	-10	-50
	Color (-#)	
	-0 Black	-2 Red

## SMD Clips & SMD Tweezers

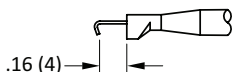

CT3218

### MiniPro Miniature Test Clips

Do-it-yourself miniature hook clip for general purpose electronic testing. With a compact size and easy to solder assembly, the clips are ideally suited for today's tight measurement needs. The clips feature smooth, soft touch actuation and the hook contacts are made of high quality gold plated BeCu. Clips are available in 10 colors for easy circuit identification. The MiniPro clips also feature a snap-lock to securely fix the cap to the body.

- IEC 61010-031 rated
- Hook opens to .079" (2 mm)
- Contact hook: BeCu, gold plated
- RoHS (2011/65/EU) compliant



CT3180-2



CT3217

Model	CT3217	CT3180-#	CT3218
Type	Set	Individual	Set
IEC Rating	30 VAC / 60 VDC		
Current Max	6 A		
Color	Black & Red	See How to Order	1 of each Color
Qty / Pkg	1 Pair	10	10-Piece Clip Set

How to Order	Color (-#)									
CT3180-#	-0 Black	-1 Brown	-2 Red	-3 Orange	-4 Yellow	-5 Green	-6 Blue	-7 Violet	-8 Grey	-9 White

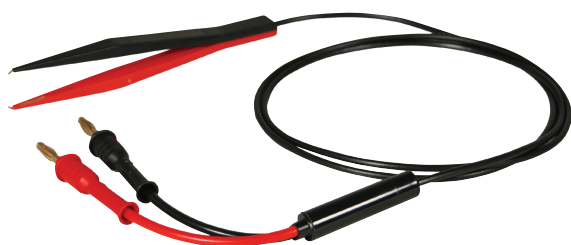

CT2301

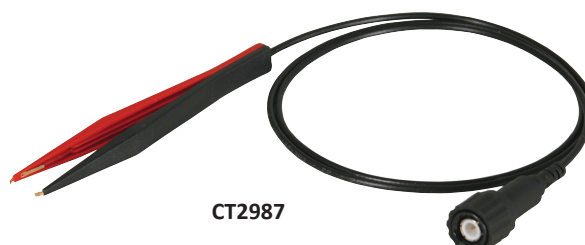

CT2987

### SMD Tweezers with Connector

- RoHS (2011/65/EU) compliant

Model	CT2301	CT2987
Connectors	(Two) 4 mm Banana Plugs, Gold Plated	BNC male Insulated
Voltage Max	400 Vrms	
Current Max	2 A	
Cable Type	RG-174/U	
Jacket Material	PVC	
Length	100 cm	

# Clips

## SMD Clips

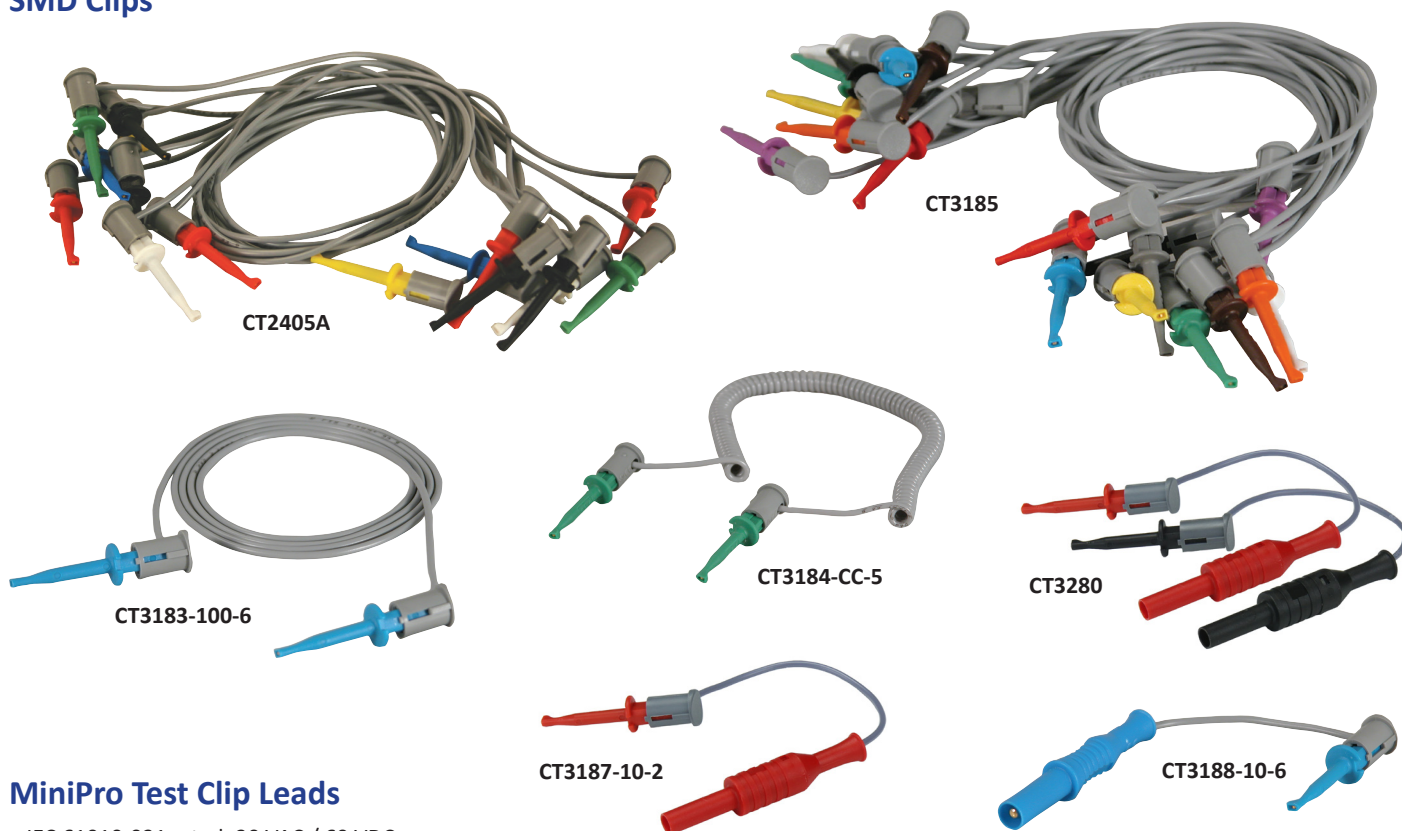

## MiniPro Test Clip Leads

- IEC 61010-031 rated: 30 VAC / 60 VDC
- Durable and flexible PVC jacketed wire
- Wire gauge: 21 AWG; OD: 2 mm (.079")
- Conductor area: 0.40 mm<sup>2</sup>
- Stranding: 104 x 0.07 mm
- RoHS (2011/65/EU) compliant

Model	CT2405A	CT3185	CT3183-100-#	CT3184-CC-#	CT3280	CT3187-10-#	CT3188-10-#
Type	Kit		Individual		Set	Individual	
One End	MiniPro Clip						
Other End	MiniPro Clip			MiniPro Clip Coiled Wire	4 mm Sheath Banana Jack		4 mm Sheath Banana Plug
IEC Rating	30 VAC / 60 VDC						
Current Max	6 A						
Length	100 cm	50 cm	100 cm	70 cm	10 cm		
Color	2 Black, 2 Red, 1 Yellow, 1 Green, 1 Blue, 1 White	1 Black, 1 Brown, 1 Red, 1 Orange, 1 Yellow, 1 Green, 1 Blue, 1 Violet, 1 Grey, 1 White	See How to Order		Black & Red		See How to Order
Qty / Pkg	1		10		1 Pair		10

How to Order	Color (-#)	
CT3183-100-#	-0 Black	-2 Red
CT3184-CC-#	-0 Black	-2 Red
CT3187-10-#	-0 Black	-2 Red
CT3188-10-#	-0 Black	-2 Red



# Coaxial

A complete offering of adapters, attenuators and terminators are available in general purpose grade or in instrument grade. They feature a brass, nickel plated body and a BeCu gold plated contact, and are also available in kits. Coax cables & breakouts feature high quality connectors with gold plated center contacts, and silicone leads for flexibility at low temperature.

- Adapters ..... 48-53
- Kits..... 53
- Attenuators..... 54-55
- Terminators ..... 55
- Cable Assemblies..... 56
- Cable Breakouts..... 57



# Coaxial

## Adapters, Between Series



### BNC to N, General Purpose Grade

• RoHS (2011/65/EU) compliant

Model	CT2763	CT2762	CT2771
Connector Grade	General Purpose		
Type/Gender to Type/Gender	BNC male to N female	BNC female to N male	BNC female to N female
Impedance	50 Ω		
Frequency Range	DC to 4 GHz		
VSWR Max	1.30:1 DC to 4 GHz		
Body	Brass, Nickel Plt.		
Contact	Brass & BeCu, Gold Plt.		
Dielectric	PTFE		
Qty / Pkg	5		



### BNC to N, Instrument Grade

• RoHS (2011/65/EU) compliant

Model	CT3348	CT3346
Connector Grade	Instrument	
Type/Gender to Type/Gender	BNC female to N female	BNC female to N male
Impedance	50 Ω	
Frequency Range	DC to 10 GHz	
VSWR Max	1.04:1 DC to 1 GHz 1.07:1 1 to 2 GHz 1.29:1 2 to 10 GHz	1.21:1 DC to 1 GHz 1.22:1 1 to 4 GHz 1.29:1 4 to 10 GHz
Insertion Loss	0.1 dB	
Body	Brass, Nickel Plt.	
Contact	Brass & BeCu, Gold Plt.	
Dielectric	PTFE	
Qty / Pkg	1	



### BNC to SMA, General Purpose Grade

• RoHS (2011/65/EU) compliant

Model	CT3328	CT3387
Connector Grade	General Purpose	
Type/Gender to Type/Gender	BNC male to SMA female	BNC female to SMA male
Impedance	50 Ω	
Frequency Range	DC to 4 GHz	
VSWR Max	1.30:1 DC to 4 GHz	
Body	Brass, Nickel Plt.	
Contact	Brass & BeCu, Gold Plt.	
Dielectric	PTFE	
Qty / Pkg	5	

## Adapters, Between Series

Model	CT3391	CT3390	CT3389
Connector Grade	General Purpose		
Type/Gender to Type/Gender	N male to SMA female	N female to SMA male	N female to SMA female
Impedance	50 Ω		
Frequency Range	DC to 11 GHz		
VSWR Max	1.4:1 DC to 11 GHz		
Body	Brass, Nickel Plt.		
Contact	Brass & BeCu, Gold Plt.		
Dielectric	PTFE		
Qty / Pkg	1		



### N to SMA, General Purpose

- RoHS (2011/65/EU) compliant

Model	CT3340	CT3320	CT3321	CT3322
Connector Grade	Instrument			
Type/Gender to Type/Gender	N male to SMA male	N male to SMA female	N female to SMA male	N female to SMA female
Impedance	50 Ω			
Frequency Range	DC to 12 GHz		DC to 11 GHz	DC to 12 GHz
VSWR Max	1.10:1 DC to 6 GHz 1.20:1 6 to 12 GHz	1.02:1 DC to 2 GHz 1.04:1 1 to 5 GHz 1.12:1 5 to 12 GHz	1.05 + 0.005 x f (GHz)	1.06:1 DC to 2 GHz 1.21:1 1 to 4 GHz 1.22:1 4 to 12 GHz
Insertion Loss	0.03 x sqr. f(GHz) dB	0.05 dB DC to 12 GHz	0.04 x sqr. f(GHz) dB	0.05 dB DC to 12 GHz
Body	Brass, Nickel Plt.			
Contact	Brass & BeCu, Gold Plt.			
Dielectric	PTFE			
Qty / Pkg	1			



### N to SMA, Instrument Grade

- RoHS (2011/65/EU) compliant

Model	CT2940	CT2939
Connector Grade	General Purpose	
Type/Gender to Type/Gender	BNC male to Double 4 mm Banana Plugs	BNC female to Double 4 mm Banana Plugs
Voltage Max	500 Vrms	
Current Max	3 A	
Impedance	50 Ω	
Quantity / Pkg	5	



### BNC to 4mm Banana Plugs

Adapts a BNC cable, component or equipment to double banana plugs. Fits standard or sheath pair 4 mm banana jacks. Used for interconnection to power supplies, function generators and other test instruments.

- RoHS (2011/65/EU) compliant

# Coaxial

## Adapters, Between Series



CT2410



CT3161-0



CT2941

### BNC to 4mm Binding Posts

Adapts a BNC cable, component or equipment to binding posts. Connections can be made to the binding posts by spade lugs, banana plugs or wire leads.

- 0.75" (19 mm) binding post spacing
- RoHS (2011/65/EU) compliant

Model	CT2410	CT3161-#	CT2941
Connector Grade	General Purpose		
Type/Gender to Type/Gender	BNC male to Double 4 mm Binding Posts	BNC male to Single 4 mm Binding Posts	BNC female to Double 4 mm Binding Posts
Voltage Max	500 Vrms		
Current Max	3 A		
Impedance	50 Ω		
Color	n/a	See How to Order	n/a
Quantity / Pkg	10	5	

How to Order	Color (-#)	
CT3161-#	-0 Black	-2 Red



CT3888



CT3889

**New**

### Insulated BNC to 4mm Banana Plugs

Adapts male BNC cable, component or equipment to double banana plugs. Fits standard or sheath pair 4 mm banana jacks. Used for interconnection to power supplies, function generators and other test instruments.

- 0.75" (19 mm) plug spacing
- IEC 61010-031 rated (CT3889)
- RoHS (2011/65/EU) compliant

Model	CT3888	CT3889
Connector Grade	General Purpose	
Type/Gender to Type/Gender	Insulated BNC female to Double 4 mm Banana Plugs	
IEC Rating	<30 VAC / <60 VDC	1000 V CAT II / 600 V CAT III
Current Max	3 A	
Impedance	50 Ω	
Quantity / Pkg	5	



CT2412



CT2985

### Insulated BNC to 4mm Safety Banana Jacks

- 0.75" (19 mm) jack spacing
- IEC 61010-031 rated
- RoHS (2011/65/EU) compliant

Model	CT2412	CT2985
Connector Grade	General Purpose	
Type/Gender to Type/Gender	Insulated BNC male to Double 4 mm Safety Banana Jacks	Insulated BNC female to Double 4 mm Safety Banana Jacks
IEC Rating	500 V CAT 0	
Current Max	3 A	
Impedance	50 Ω	
Qty / Pkg	10	

## Adapters, In-Series



CT2765



CT2766



CT3313



CT3312



CT2411

### BNC, General Purpose Grade

• RoHS (2011/65/EU) compliant

Model	CT2765	CT2766	CT3313	CT3312	CT2411
Type	Straight		Right Angle	Tee	
Connector Grade	General Purpose				
Gender to Gender	female to female	male to male	male to female	female to female to female	female to male to female
Impedance	50 Ω				
Frequency Range	DC to 4 GHz		DC to 4 GHz (various)	DC to 4 GHz	
VSWR Max	1.30:1 DC to 4 GHz			n/a	
Insertion Loss	0.2 dB				
Body	Brass, Nickel Plt.				
Contact	BeCu, Gold Plt.	Brass, Gold Plt.	Brass & BeCu, Gold Plt.		Brass, Gold Plt.
Dielectric	PTFE				
Qty / Pkg	5		1		10

Model	CT3341
Type	Tee
Connector Grade	Instrument
Gender to Gender	female to male to female
Impedance	50 Ω
Frequency Range	DC to 6 GHz
VSWR Max	n/a
Insertion Loss	n/a
Body	Brass, White Bronze, Silver Plt.
Contact	Brass and BeCu, Gold Plt.
Dielectric	PTFE
Qty / Pkg	1



CT3341

### BNC, Instrument Grade

• RoHS (2011/65/EU) compliant

# Coaxial

## Adapters, In-Series



CT2759



CT2758



CT3388



CT2761



CT2760

## N, General Purpose Grade

- RoHS (2011/65/EU) compliant

Model	CT2759	CT2758	CT3388	CT2761	CT2760
Type	Straight		Right Angle	Tee	
Connector Grade	General Purpose				
Gender to Gender	male to male	female to female	male to female	female to female to female	female to male to female
Impedance	50 Ω				
Frequency Range	DC to 8 GHz	DC to 11 GHz	DC to 8 GHz (various)		DC to 8 GHz
VSWR Max	1.30:1 DC to 8 GHz		1.35:1 DC to 8 GHz	n/a	
Insertion Loss	--	--	--	n/a	
Body	Brass, Nickel Plt.				
Contact	Brass, Gold Plt.				
Dielectric	PTFE				
Qty / Pkg	5		1	5	

CT3350



CT3351

Model	CT3351	CT3350
Type	Straight	
Connector Grade	Instrument	
Gender to Gender	male to male	female to female
Impedance	50 Ω	
Frequency Range	DC to 11 GHz	
VSWR Max	1.04:1 DC to 2 GHz 1.07:1 2 to 4 GHz 1.12:1 4 to 9 GHz	1.05:1 DC to 2 GHz 1.12:1 2 to 4 GHz 1.17:1 4 to 9 GHz
Insertion Loss	<0.05 dB DC to 9 GHz	
Body	Brass, White Bronze, Silver Plt.	
Contact	Brass and BeCu, Gold Plt.	
Dielectric	PTFE	
Qty / Pkg	1	

## N, Instrument Grade

- RoHS (2011/65/EU) compliant



## Adapters & Kits

Model	CT3673	CT3674
Type	Straight	Tee
Connector Grade	General Purpose	
Gender to Gender	male to female	female to male to female
Impedance	50 Ω	
Frequency Range	12 GHz	12.5 GHz
VSWR Max	1.14:1	n/a
Insertion Loss	0.25 dB	n/a
Body	Stainless Steel, Passivated	
Contact	BeCu, Gold Plt.	
Dielectric	PTFE	
Qty / Pkg	5	



CT3673



CT3674

### SMA, General Purpose Grade Adapters

- RoHS (2011/65/EU) compliant

Rating	
Connector Grade	General Purpose
Impedance	50 Ω & Various
Kit Contains	
(6) Central Universal connectors plus the following Adapters:	
Type	Gender & (Quantity)
BNC	male (2), female (2)
F	male (1), female (1)
N	male (2), female (2)
RCA	male (1), female (1)
SMA	male (1), female (1)
TNC	male (2), female (2)
UHF	male (2), female (2)
Mini-UHF	male (1), female (1)

### Universal Coaxial Adapter Kit

Model	CT2701A
-------	---------

This adapter kit allows you to create any combination of in-series and between-series coax adapters for BNC, N, F, TNC, RCA, UHF, Mini-UHF and SMA connectors. This is done by screwing together two separate adapters to a universal center adapter. All pieces are machined brass with Teflon dielectrics and gold plated center contacts. Whether field service or bench, this adapter kit provides an easy solution to coaxial connection requirements.

- 30-piece kit
- RoHS (2011/65/EU) compliant
- Comes in a protective foam lined case



Rating	
Connector Grade	General Purpose
Impedance	50 Ω
Frequency Range	DC to 8 GHz
Kit Contains	
(1) BNC female to male to female Tee Adapter	
(1) N female to female Adapter	
(1) N male to male Adapter	
(1) N female to male to female Tee Adapter	
(1) N female to female to female Tee Adapter	
(1) BNC female to N male Adapter	
(1) BNC male to N female Adapter	
(1) BNC female to female Adapter	
(1) BNC male to male Adapter	
(1) BNC female to N female Adapter	
(1) BNC female to female to female Tee Adapter	
(1) N male to female Right-Angle Adapter	

### BNC and N Coaxial Adapter Kit

Model	CT2702A
-------	---------

- 12-piece kit
- RoHS (2011/65/EU) compliant
- Comes in a protective foam lined case



## Attenuators



### BNC, 50 Ω, Male to Female Attenuators

Instrument grade BNC male to female 50 Ω fixed coaxial attenuators are linear, passive transmission line components designed to reduce the input power in a matched system. They are intended for laboratory, production, testing and system use. Typical applications include VSWR reduction at the insertion point, range extension of power meters, RF path loss simulation, and isolation or power level reduction of signal sources.

- Available in 7 popular attenuation ranges
- High quality construction
- Excellent VSWR
- Usable to 4 GHz
- Contact BeCu, gold plated
- RoHS (2011/65/EU) compliant
- Available in 6-piece kit CT3382A shown on page 55

### Attenuation up to 10 dB

Model	CT3369A-03	CT3369A-06	CT3369A-08	CT3369A-10
Connector Grade	Instrument			
Gender	male to female			
Attenuation (dB) / (V)	3 dB / 1.4x	6 dB / 2x	8 dB / 2.5x	10 dB / 3.2x
Impedance	50 Ω			
Frequency Range	DC to 4 GHz			
VSWR	1.25:1 DC to 4 GHz			
Avg. Power	2 W			
Peak Power	250 W			
Accuracy	+0.5 dB Max			
Body	Brass, Nickel Plt.			
Contacts	BeCu, Gold Plt.			
Quantity / Pkg	1			

### Attenuation 14 dB and above

Model	CT3369A-14	CT3369A-20	CT3369A-30
Connector Grade	Instrument		
Gender	male to female		
Attenuation (dB) / (V)	14 dB / 5x	20 dB / 10x	30 dB / 100x
Impedance	50 Ω		
Frequency Range	DC to 4 GHz		
VSWR	1.25:1 DC to 4 GHz		
Avg. Power	2 W		
Peak Power	250 W		
Accuracy	+0.5 dB Max	+0.75 dB Max	
Body	Brass, Nickel Plt.		
Contacts	BeCu, Gold Plt.		
Quantity / Pkg	1		

### Attenuator BNC, 50 Ω, 6-Piece Kit

Kit contains six (6) precision CT3369A BNC, 50 Ω, male to female coaxial attenuators in a convenient kit.

Comes in a foam-lined wooden case.

- RoHS (2011/65/EU) compliant



CT3382A

Model	CT3382A
Type	Kit (Six Attenuators)
Connector Grade	Instrument
Gender	male to female
Attenuation (dB)	3, 6, 8, 10, 14 & 20 dB
Attenuation (V)	1.4x, 2x, 2.5x, 3.2x, 5x & 10x
Impedance	50 Ω
Frequency Range	DC to 4 GHz
VSWR	1.25:1 DC to 4 GHz (Avg.)
Avg Power	2 W
Peak Power	250 W
Accuracy	+0.5 dB Max
Body	Brass, Nickel Plt.
Contacts	BeCu, Gold Plt.

### Attenuator N, 50 Ω, Male to Female

Instrument grade male to female 50 Ω fixed coaxial attenuator.

- High quality construction
- Excellent VSWR
- Usable to 12.4 GHz
- RoHS (2011/65/EU) compliant



CT3353-10

Model	CT3353-10
Connector Grade	Instrument
Gender	male to female
Attenuation (dB) / (V)	10 dB / 3.2x
Impedance	50 Ω
Frequency Range	DC to 12.4 GHz
VSWR	1.15:1 DC to 4 GHz 1.25:1 4 to 12.4 GHz
Avg Power	2 W
Peak Power	500 W
Accuracy	+0.75 dB Max
Body	Stainless Steel, Passivated
Contacts	BeCu, Gold Plt.
Quantity / Pkg	1

### BNC Coaxial Terminators

BNC feed-thru terminators match higher impedance devices to the input impedance of the test equipment. End terminators match the characteristic impedance of the transmission line.

- High quality construction
- Excellent VSWR
- 50 Ω feed-thru up to 2 GHz
- Contact BeCu, gold plated
- RoHS (2011/65/EU) compliant



CT2944-50  
CT2944-75  
CT2944-93



CT3334-50

Model	CT2944-50	CT2944-75	CT2944-93	CT3334-50
Style	Feed-Thru			Term
Connector Grade	General Purpose			
Gender	male to female			male
Impedance	50 Ω	75 Ω	93 Ω	50 Ω
Frequency Range	DC to 2 GHz	DC to 1 GHz		DC to 500 MHz
VSWR	1.10:1 DC to 500 MHz 1.20:1 500 MHz to 2 GHz	1.10:1 DC to 500 MHz 1.20:1 500 MHz to 1 GHz		--
Power	2 W	1 W		1/2 W
Input Voltage	≤10 VDC / 20 VAC p-p	≤8 VDC / 16 VAC p-p	≤10 VDC / 20 VAC p-p	--
Accuracy	0.5%			--
Body	Brass, Nickel Plt.			
Contacts	BeCu, Gold Plt.			
Qty / Pkg	1			

# Coaxial

## Cable Assemblies



## Coaxial Cable Assemblies

### BNC, N, SMA

- IEC 61010-031 rated
- RoHS (2011/65/EU) compliant

Model	CT2942-L	CT2417-L-#	CT3331-100	CT3333-60	CT3396-100	CT3330-60
Connectors Type	BNC male to BNC male	Insulated BNC male to Insulated BNC male	N male to N male	SMA male to SMA male		SMA male to BNC male
Connector Grade	General Purpose					
IEC Rating	n/a	500 V CAT 0	n/a			
Impedance	50 Ω					
Frequency Range	DC to 1 GHz	DC to 2 GHz	DC to 12.4 GHz	DC to 18 GHz	DC to 6 GHz	DC to 4 GHz
VSWR Max	1.2:1 DC to 1 GHz	--	1.4:1 DC to 12.4 GHz	1.3:1 DC to 18 GHz	1.3:1 DC to 6 GHz	1.3:1 DC to 4 GHz
Insertion Loss	--	--	0.7 dB/ft		0.9 dB/ft	0.7 dB/ft
Cable Type	RG-58C/U	Custom Coax	SRC-402SF		SRC-316	SRC-402SF
Jacket Material	PVC Highly Flexible		FEP, White		PVC, White	FEP, White
Insulated BNC	No	Yes	No			
Qty / Pkg	5	10	1			
Length	See How to Order		100 cm	60 cm	100 cm	60 cm
Color	Black	See How to Order	Not Applicable			

Model	How to Order							
CT2417-L-#	Length cm (-L)							
	--	--	--	-100	--	--	-200	--
	Color (-#)							
	-0 Black	--	--	--	--	--	--	--
CT2942-L	Length cm (-L)							
	-25	-50	--	-100	-120	-150	-200	-250

## Cable Breakouts

### Coaxial Cable Breakout Assemblies

#### BNC Male

- PVC molded boot relief
- RoHS (2011/65/EU) compliant

Model	CT3158-100	CT3230-100
Connectors	BNC male to Alligator Clips	BNC male to MiniPRO IC Test Clips
Voltage Max	500 Vrms	
Current Max	3 A	
Cable Type	RG-58C/U	
Jacket Material	PVC	
Impedance	50 Ω	
Length	100 cm	
Color	Black	
Qty / Pkg	5	



#### Breakouts, Insulated BNC Female

- IEC 61010-031 rated
- Flexible silicone breakout leads
- Breakout length: 25 cm
- RoHS (2011/65/EU) compliant

Model	CT3264	CT3269	CT3270
Connectors	BNC female to Blunt Wire Cut Ends	BNC female to MiniPRO IC Test Clips	BNC female to Miniature Alligator Clips
IEC Rating	33 VAC / 70 VDC		
Current Max	6 A	2 A	
Impedance	50 Ω		
Conductor Area	0.40 mm <sup>2</sup>		
Wire Gauge	21 AWG		
Stranding (# x Diam.)	100 x 0.07 mm		
Qty / Pkg	2		



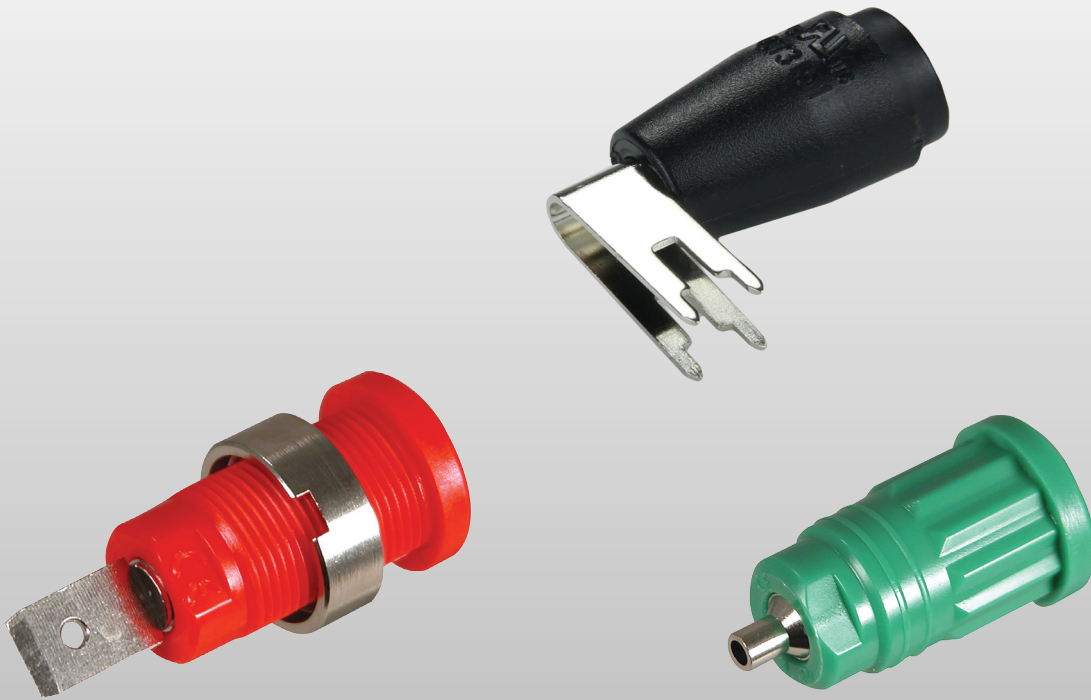

## Banana Jacks

Cal Test Electronics offers a full line of 4 mm jacks to meet your interconnection needs. The family includes standard panel jacks, binding posts, and specialty jacks that when attached turns a standard jack into a safety version.

All are made of the highest quality material and exacting standards, just what you need to build your next product or test fixture.

In-Line DIY Assembly .....	59
Panel Mount & Accessories .....	60, 61, 63
PCB Mount .....	62
Binding Posts .....	63
Adapters .....	62

# Banana Jacks

## In-Line DIY Assembly

Model	CT2213-#	CT2215-#
Type	Individual	
Wire Attachment	Solder	Set Screw
IEC Rating	30 VAC / 60 VDC	
Voltage, Max	1,200 VAC / VDC	
Current, Max	36 A	
Body Insulation	Polyamide (Nylon)	
Contacts	Brass, Nickel Plt.	
Cable Diam. up to	3.9 mm (.154") Max	
For Wires up to	2.5 mm <sup>2</sup> 13 AWG	
Assembly	n/a	Requires Small Screwdriver
Color	See How to Order	
Qty / Pkg	50	



### In-Line 4mm Banana Jacks, Insulated, DIY Assembly

**For Solder Assembly Model CT2213:** Solder wire attachment, then thread jack into the insulator.

**For Solderless Assembly Model CT2215:** Screw down clamp for solderless wire attachment, then thread jack into the insulator.

- IEC 61010-031 rated
- RoHS (2011/65/EU) compliant

How to Order	Color (-#)					
CT2213-#	-0 Black	-2 Red	-4 Yellow	-5 Green	-6 Blue	-9 White
CT2215-#	-0 Black	-2 Red	-4 Yellow	-5 Green	-6 Blue	-9 White



Model	CT3207	CT3207W	CT3134-#	CT3134-S-#
Type	Set		Individual	
Wire Attachment	Set Screw			Solder
*IEC Rating	1,000 V CAT III			1,000 V CAT III / 600 V CAT IV
Current, Max	36 A			
Body Insulation	Polyamide (Nylon)			
Contacts	Brass, Nickel Plt.			
Cable Diam. up to	3.9 mm (.154") Max			
For Wires up to	2.5 mm <sup>2</sup> 13 AWG			
Assembly	Requires 1.5 mm Allen Wrench	Includes 1.5 mm Allen Wrench	Requires 1.5 mm Allen Wrench	n/a
Color	Black & Red		See How to Order	
Qty / Pkg	1 Pair		10	



### In-Line 4mm Banana Jacks, Sheath, Fully Insulated, DIY Assembly

Fully Insulated. Do-it-yourself connection. 2-piece assembly.

- IEC 61010-031 rated
- RoHS (2011/65/EU) compliant

\* IEC Rating when using equally rated lead wire.

How to Order	Color (-#)					
CT3134-#	-0 Black	-2 Red	-4 Yellow	-5 Green	-6 Blue	-9 White
CT3134-S-#	-0 Black	-2 Red	-4 Yellow	-5 Green	-6 Blue	-9 White

# Banana Jacks

## Panel Mount & Accessories

### 4mm Sheath Banana Jacks Panel Mount w/Panel Nut

4 mm safety banana jack (socket) accepts sheath or shrouded banana plugs and meets IEC 61010-031 to 1,000 V CAT III and 600 V CAT IV. Round panel nut allows for compact placement and easy assembly.

- IEC 61010-031 rated
- Materials: body: polyamide (nylon); jack and nut: brass, nickel plt.
- Maximum panel thickness: .40" (10 mm)
- M12 x 0.75 mm thread
- Use assembly tool CT2246A
- RoHS (2011/65/EU) compliant

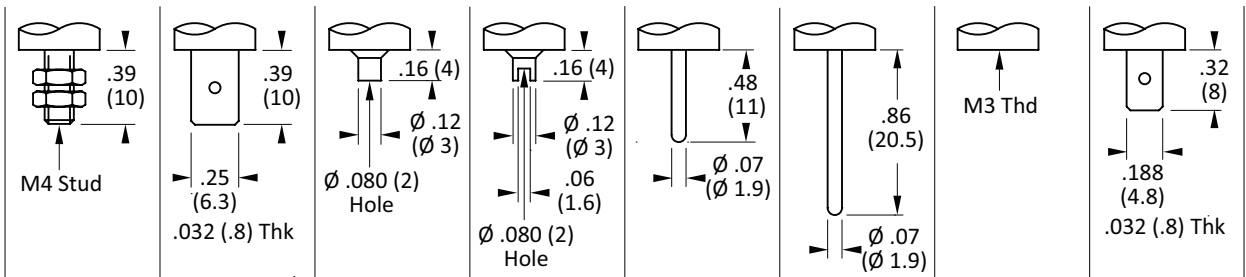
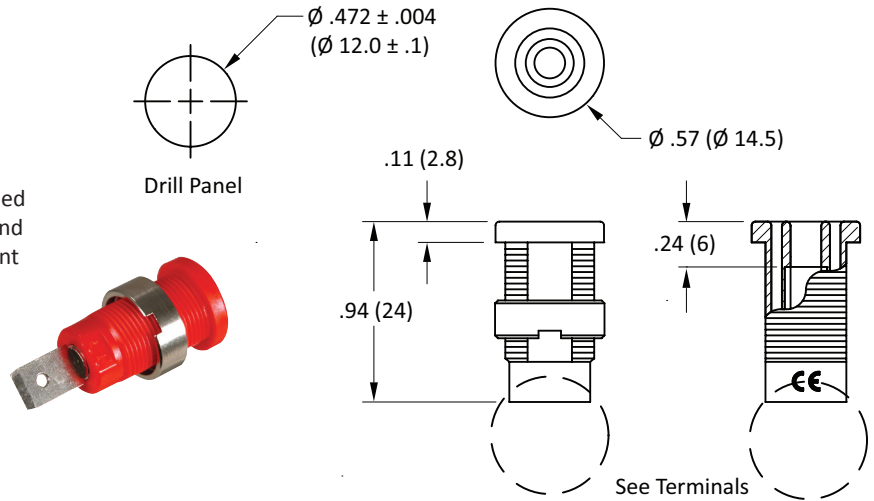

Model	CT2236-#	CT2238-#	CT2240-#	CT2242-#	CT2904-#	CT2906-#	CT2908-#	CT2910-#
IEC Rating	1,000 V CAT III / 600 V CAT IV							
Current Max	36 A		25 A			36 A		
Termination	M4 Threaded Stud	.25" (6.4 mm) Faston®	.080" (2 mm) solder hole	.080" (2 mm) solder slot	1.9 mm diam. x 12 mm short pin	1.9 mm diam. x 21 mm long pin	M3 threaded hole	.188" (4.8 mm) Faston®
Color	See How to Order							
Qty / Pkg	50							

How to Order									
Model-#	Color (-#)								
		-0 Black	-1 Brown	-2 Red	-4 Yellow	-5 Green	-6 Blue	-7 Violet	-8 Grey

## Panel Mount Banana Jack Accessories

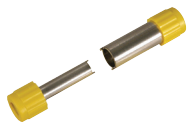

### Wrench Set

**Model** CT2246A  
2-piece assembly wrench for panel mount 4 mm safety jacks.  
RoHS (2011/65/EU) compliant



### Replacement Nut

**Model** CT2830  
Materials: brass, nickel plt.  
Thread: M12 x 0.75 mm  
RoHS (2011/65/EU) compliant  
Sold in package of 100



### Banana Jack Standoff

**Model** CT2667-#  
Standoff for raising banana jacks 11 mm above panel. Materials: polyamide (nylon). Max voltage rating for socket using standoff: 600 V CAT III.  
RoHS (2011/65/EU) compliant  
Sold in package of 50

Model	Color
CT2667-0	Black
CT2667-2	Red
CT2667-4	Yellow
CT2667-5	Green
CT2667-8	Grey

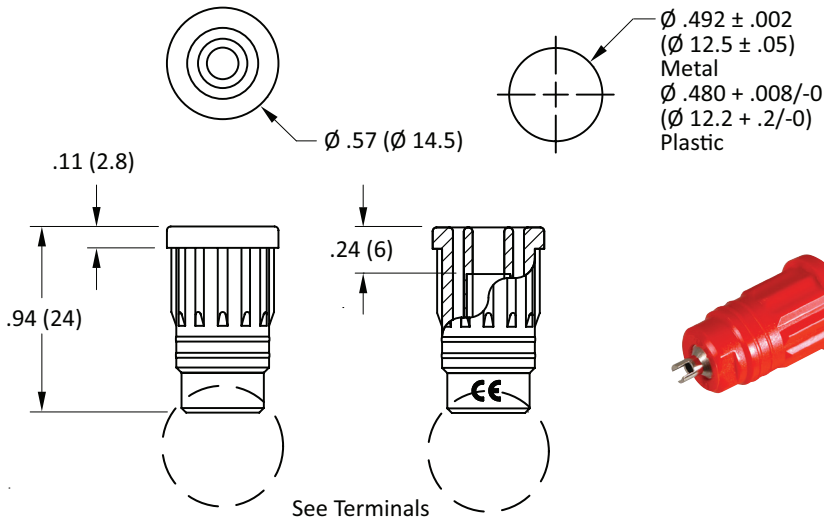

### 4mm Sheath Banana Jacks Panel Mount, Press Fit

4 mm safety banana jack (socket) accepts sheath or shrouded banana plugs and meets IEC 61010-031 to 1,000 V CAT III and 600 V CAT IV. Fast push-in assembly in either metal or plastic panels.

- IEC 61010-031 rated
- Materials: body: polyamide (nylon); jack: brass, nickel pl.
- Minimum panel thickness: plastic .080" (2 mm); metal .060" (1.5 mm)
- RoHS (2011/65/EU) compliant

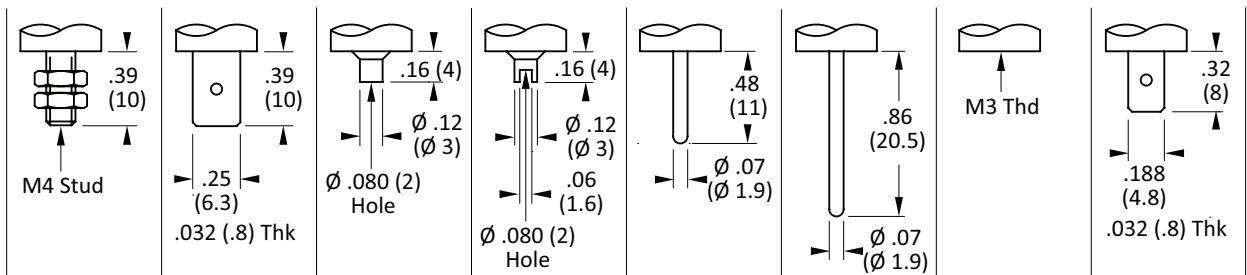

Model	CT2243-#	CT2244-#	CT2245-#	CT2911-#	CT2912-#	CT2913-#	CT2914-#	CT2915-#
IEC Rating	1,000 V CAT III / 600 V CAT IV							
Current Max	36 A		25 A	36 A				
Termination	M4 Threaded Stud	.080" (2 mm) solder hole	.080" (2 mm) solder slot	.25" (6.3 mm) Faston®	1.9 mm diam. x 12 mm short pin	1.9 mm diam. x 21 mm long pin	M3 threaded hole	.188" (4.8 mm) Faston®
Color	See How to Order							
Qty / Pkg	50							

#### How to Order

Model-#	Color (-#)								
	-0 Black	-1 Brown	-2 Red	-4 Yellow	-5 Green	-6 Blue	-7 Violet	-8 Grey	-9 White

# Banana Jacks

## PCB Mount & Adapters

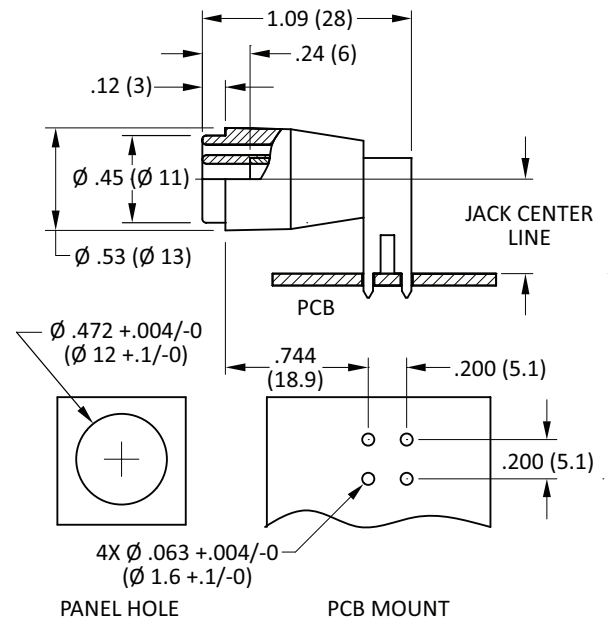
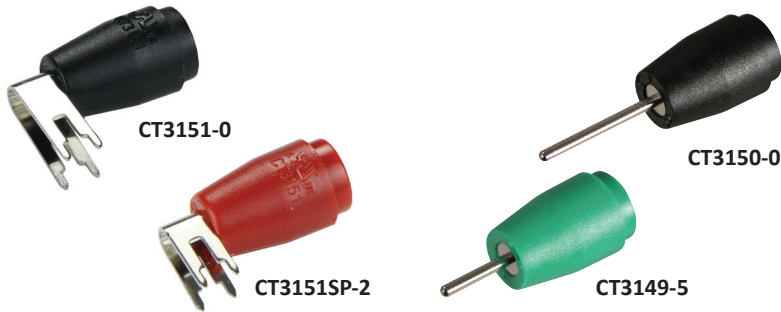

### 4mm Sheath Banana Jacks (Sockets), PCB Mount

- IEC 61010-031 rated: 1000 V CAT III
- Current Max: 25 A
- Materials: body: polyamide (nylon); jack: brass, nickel plt.
- Panel thickness: .118" (3 mm)
- 4 mm safety jack (socket) accepts sheath or shrouded banana plugs
- RoHS (2011/65/EU) compliant

Model	CT3151-#	CT3151SP-#	CT3149-#	CT3150-#
Mounting into PCB	4 Terminals into PCB Pad		1.9 mm Diam. x 12 mm Short Pin for insertion into a PCB	1.9 mm Diam. x 21 mm Long Pin for insertion into a PCB
Jack Center Line	.492" (12.5 mm) above PCB Surface	.300" (7.6 mm) above PCB Surface	Not applicable	
UL Recognized	per PICQ2 and PICQ8 E315929		Not applicable	
Color	See How to Order			
Qty / Pkg	100		50	

How to Order									
Model-#	Color (-#)								
		-0 Black	-1 Brown	-2 Red	-4 Yellow	-5 Green	-6 Blue	-7 Violet	-8 Grey

### Banana Jack Adapters



Adapter turns a standard 4 mm banana jack into a safety jack. The jack will now accept a sheath 4 mm banana plug. Assemble with a 1.5 mm Allen wrench (CT2919) to provide a firm attachment. Materials: Body: polyamide (nylon); jack: brass, nickel plt.

- IEC 61010-031 rated
- RoHS (2011/65/EU) compliant

Model	CT2575-#	CT2247-#
IEC Rating	400 V CAT 0	1,000 V CAT 0
Current Max	36 A	
Color	See How to Order	
Qty / Pkg	10	

How to Order		
Model-#	Color (-#)	
		-0 Black



### Allen Wrench, 1.5mm

Assembly wrench for safety adapters and DIY sheathed plugs and jacks. Materials: steel  
RoHS (2011/65/EU) compliant  
Sold in package of 5



## 4mm Standard Banana Jacks (Sockets)

### Un-Insulated, Panel Mount

- For direct mounting to a panel
- Great for grounding point
- Materials: jack and nut: brass, nickel plt.
- M6 x 0.75 mm thread
- RoHS (2011/65/EU) compliant

Model	CT2220	CT2224
Current Max	36 A	
Termination	Solder Hole	Thru Hole
Qty / Pkg	50	



### Panel Mount & Binding Posts

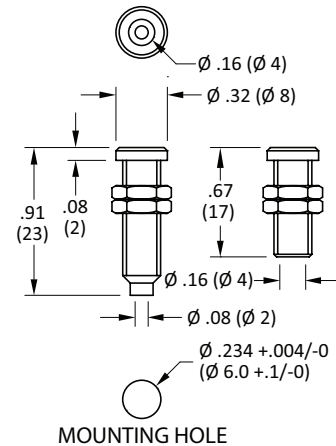

## 4mm Standard Banana Jacks (Sockets)

### Insulated, Panel Mount

- IEC 61010-031 rated
- For direct mounting to a panel
- Materials: body: polyamide (nylon); jack: brass, nickel plt.
- Maximum panel thickness: .20" (5 mm)
- M6 x 0.75 mm thread
- RoHS (2011/65/EU) compliant

Model	CT2228-#	CT2230-#
IEC Rating	30 VAC / 60 VDC	
Voltage Max	1,200 VAC / VDC	
Current Max	36 A	
Termination	Solder Hole	Thru Hole
Color	See How to Order	
Qty / Pkg	50	

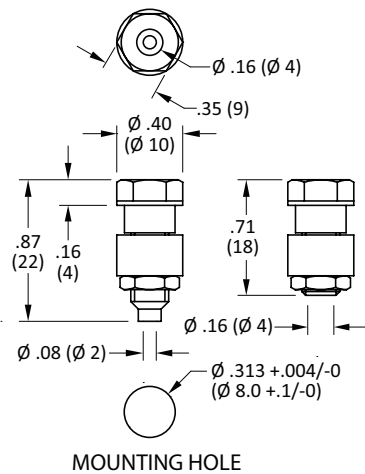

How to Order	Color (-#)					
CT2228-#	-0 Black	-2 Red	-4 Yellow	-5 Green	-6 Blue	-9 White
CT2230-#	-0 Black	-2 Red	-4 Yellow	-5 Green	-6 Blue	-9 White

## Binding Posts, Panel Mount

- IEC 61010-031 rated
- 4 mm standard banana jack w/ 2 mm cross hole
- Material: body: polyamide (nylon); jack: brass, nickel plt.
- M6 x 0.75 mm thread
- RoHS (2011/65/EU) compliant

Model	CT2232-#	CT2234-#
Type	Insulated	Uninsulated
IEC Rating	30 VAC / 60 VDC	
Voltage Max	1,200 VAC / VDC	
Current Max	36 A	
Color	See How to Order	
Quantity / Pkg	50	

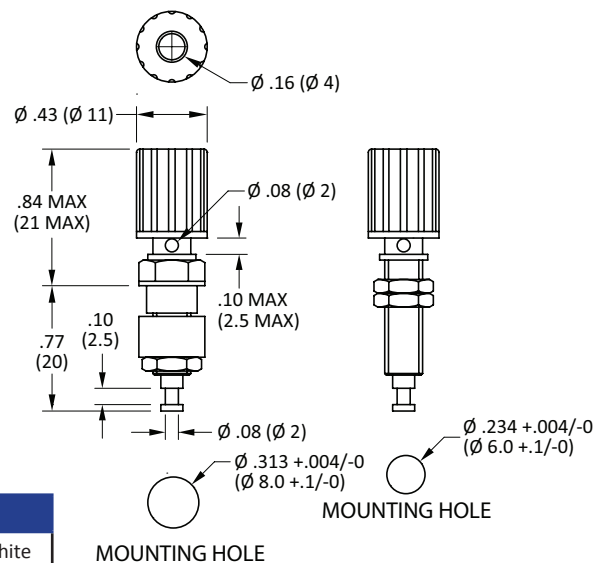

How to Order	Color (-#)					
CT2232-#	-0 Black	-2 Red	-4 Yellow	-5 Green	-6 Blue	-9 White
CT2234-#	-0 Black	-2 Red	--	--	--	--



## Banana Plugs

The most extensive line of plugs and leads on the market today. This category includes standard banana plugs, both with in-line and stackable configurations with either solder or solderless connections. Also included are sheath, stackable, retractable and DIY plugs. All are made of the highest quality material to exacting standards.

Standard .....	65
Double .....	66
Sheath .....	66-67
Retractable Sleeve .....	68
Test Leads .....	69-73
Technical Reference .....	88-89

# Banana Plugs

Standard



Model	CT2002-#	CT2011-#	CT3276-#	CT3249-#
Wire Attachment	Solder	Set Screw		*Spring-loaded Button
Type	Individual			
IEC Rating	30 VAC / 60 VDC			
Voltage Max	1,200 VAC / VDC			
Current Max	36 A		20 A	
Body Insulation	Polyamide (Nylon)		Santoprene	Polyamide (Nylon)
Plug & Contact Material	Brass & BeCu, Nickel Plt.			
Wire Max	2.5 mm <sup>2</sup> (13 AWG) 3.9 mm (.154") Max			
Assembly	n/a	Requires Small Screwdriver		n/a
Color	See How to Order			
Qty / Pkg	100	50	10	

## 4mm Banana Plugs Insulated, Straight In-line

Do-It-Yourself with 3 styles of wire attachment.

- IEC 61010-031 rated
- RoHS (2011/65/EU) compliant

\* Depress the spring loaded button, insert the wire and release. The connection is completed including a secure grip on the wire's insulation.

How to Order						
Model-#	Color (-#)					
	-0 Black	-2 Red	-4 Yellow	-5 Green	-6 Blue	-9 White

Model	CT2013-#	CT2016-#
Wire Attachment	Set Screw	*Spring- Loaded Clamp
Type	Individual	
IEC Rating	30 VAC / 60 VDC	
Voltage Max	1,200 VAC / VDC	
Current Max	36 A	
Body Insulation	Polyamide (Nylon)	
Plug & Contact Material	Brass & BeCu, Nickel Plt.	
Wire Max	2.5 mm <sup>2</sup> (13 AWG) 3.9 mm (.154") Max	
Assembly	Requires Small Screwdriver	n/a
Color	See How to Order	
Qty / Pkg	10	

\* Depress the spring loaded clamp, insert the wire and release. The connection is completed including a secure grip on the wire's insulation.

How to Order						
Model-#	Color (-#)					
	-0 Black	-2 Red	-4 Yellow	-5 Green	-6 Blue	-9 White



## 4mm Banana Plugs, Stacking

Do-It-Yourself with 2 styles of solderless wire attachment.

- IEC 61010-031 rated
- Solderless connection
- RoHS (2011/65/EU) compliant

# Banana Plugs

## Sheath and Double



CT3250-5

## 4mm Banana Plugs Sheath, In-Line

Do-It-Yourself safety plugs.

- IEC 61010-031 rated
- CT2989 and CT3205 3-piece assembly
- RoHS (2011/65/EU) compliant

Model	CT3250-#	CT3205	CT3205W	CT2989-#	CT2989-S-#
Wire Attachment	*Spring- Loaded Button	Set Screw		Solder	
Type	Individual	Set		Individual	
**IEC Rating	600 V CAT II	1,000 V CAT III			1,000 V CAT III / 600 V CAT IV
Current Max	20 A	36 A			
Body Insulation	Polyamide (Nylon)				
Plug & Contact Material	Brass & BeCu, Nickel Plt.				
Wire Max	2.5 mm <sup>2</sup> (13 AWG) 3.9 mm (.154") Max				
Assembly	n/a	Requires 1.5 mm Allen Wrench	Includes 1.5 mm Allen Wrench	Requires 1.5 mm Allen Wrench	n/a
Color	See How to Order	Black & Red		See How to Order	
Qty / Pkg	10	1 Pair		10	

\* Depress the spring loaded button, insert the wire and release. The connection is completed including a secure grip on the wire's insulation.

\*\* IEC Rating when using equally rated lead wire.

How to Order						
Model	Color (-#)					
CT3250-#	-0 Black	-2 Red	--	--	--	--
CT2989-#	-0 Black	-2 Red	-4 Yellow	-5 Green	-6 Blue	-9 White
CT2989-S-#	-0 Black	-2 Red	-4 Yellow	-5 Green	-6 Blue	-9 White



CT3160-2

## 4mm Double Banana Plugs

Molded 4 mm double banana plug.

Do-It-Yourself assembly without solder.

- IEC 61010-031 rated
- RoHS (2011/65/EU) compliant

How to Order		
Model	Color (-#)	
CT3160-#	-0 Black	-2 Red

Model	CT3160-#
Wire Attachment	Set Screws
Type	Individual
IEC Rating	30 VAC / 60 VDC
Voltage Max	5,000 VDC
Current Max	15 A
Body Insulation	ABS
Plug & Contact Material	Brass & BeCu, Nickel Plt.
Wire Max	18 - 22 AWG 5.5 mm (.21")
Assembly	Requires Small Screwdriver
Color	See How to Order
Quantity / Pkg	10

# Banana Plugs

Sheath



Model	CT3206	CT3206W	CT2631-#	CT2631-S-#
Style	Straight			
Wire Attachment	Set Screw			Solder
Type	Set		Individual	
*IEC Rating	600 V CAT IV / 1,000 V CAT III			
Current Max	36 A			
Body Insulation	Polyamide (Nylon)			
Plug & Contact Material	Brass & BeCu, Nickel Plt.			
Wire Max	2.5 mm <sup>2</sup> (13 AWG) 3.9 mm (.154") Max			
Assembly	Requires 1.5 mm Allen Wrench	Includes 1.5 mm Allen Wrench	Requires 1.5 mm Allen Wrench	n/a
Color	Black & Red		See How to Order	
Qty / Pkg	1 Pair		10	

\* IEC Rating when using equally rated lead wire.

How to Order						
Model	Color (-#)					
CT2631-#	-0 Black	-2 Red	-4 Yellow	-5 Green	-6 Blue	-9 White
CT2631-S-#	-0 Black	-2 Red	-4 Yellow	-5 Green	-6 Blue	-9 White

## 4mm Banana Plugs Sheath, Stacking

Do-It-Yourself stacking safety plugs.

- IEC 61010-031 rated
- 3-piece assembly
- RoHS (2011/65/EU) compliant

**New**

Model	CT3204	CT3204W	CT3203-#	CT3203-S-#
Style	Right-Angle			
Wire Attachment	Set Screw			Solder
Type	Set		Individual	
*IEC Rating	1,000 V CAT III			1,000 V CAT III / 600 V CAT IV
Current Max	20 A			
Body Insulation	Polyamide (Nylon)			
Plug & Contact Material	Brass & BeCu, Nickel Plt.			
Wire Max	2.5 mm <sup>2</sup> (13 AWG) 3.9 mm (.154") Max			
Assembly	Requires 1.5 mm Allen Wrench	Includes 1.5 mm Allen Wrench	Requires 1.5 mm Allen Wrench	n/a
Color	Black & Red		See How to Order	
Qty / Pkg	1 Pair		10	

\* IEC Rating when using equally rated lead wire.

How to Order						
Model	Color (-#)					
CT3203-#	-0 Black	-2 Red	-4 Yellow	-5 Green	-6 Blue	-9 White
CT3203-S-#	-0 Black	-2 Red	-4 Yellow	-5 Green	-6 Blue	-9 White



## 4mm Banana Plugs Sheath, Right-Angle

Do-It-Yourself right-angle safety plugs.

- IEC 61010-031 rated
- 3-piece assembly
- RoHS (2011/65/EU) compliant

# Banana Plugs

## Retractable Sleeve



## 4mm Banana Plugs Retractable Sleeve, In-line or Stacking

Do-It-Yourself plugs with retractable sleeves.

- IEC 61010-031 rated
- CT3200 series 5-piece assemblies
- RoHS (2011/65/EU) compliant



Model	CT3202	CT3202W	CT3201-#	CT3201-S-#	CT2015-#	CT2017-#
Style	In-Line			Stacking		
Wire Attachment	Set Screw			Solder	Set Screw	**Spring- Loaded Clamp
Type	Set		Individual			
IEC Rating	*600 V CAT II				30 VAC / 60 VDC	
Voltage Max	--	--	--	--	1,200 VAC / VDC	
Current Max	36 A					
Body Insulation	Polyamide (Nylon)					
Plug & Contact Material	Brass & BeCu, Nickel Plt.					
Wire Max	2.5 mm <sup>2</sup> (13 AWG) 3.9 mm (.154") Max					
Assembly	Requires 1.5 mm Allen Wrench	Includes 1.5 mm Allen Wrench	Requires 1.5 mm Allen Wrench	n/a	Requires Small Screwdriver	n/a
Color	Black & Red		See How to Order			
Qty / Pkg	1 Pair		10			

\* IEC Rating when using equally rated lead wire.

\*\* Depress the spring loaded clamp, insert the wire and release. The connection is completed including a secure grip on the wire's insulation.

How to Order						
Model	Color (-#)					
CT3201-#	-0 Black	-2 Red	-4 Yellow	-5 Green	-6 Blue	-9 White
CT3201-S-#	-0 Black	-2 Red	-4 Yellow	-5 Green	-6 Blue	-9 White
CT2015-#	-0 Black	-2 Red	-4 Yellow	-5 Green	-6 Blue	-9 White
CT2017-#	-0 Black	-2 Red	-4 Yellow	-5 Green	-6 Blue	-9 White





CT2060-100-2  
CT2062-100-2



CT3637-100-0

### 4mm Banana Plug Straight Plug to Straight Plug

Standard 4 mm banana plug for all basic interconnection applications.

- IEC 61010-031 rated
- With highly flexible silicone or PVC jacketed lead wire
- RoHS (2011/65/EU) compliant

Model	CT2062-L-#	CT2060-L-#
Type	Individual	
IEC Rating	30 VAC / 60 VDC	
Voltage Max	1,200 VAC / VDC	
Current Max	12 A	
Jacket Material	Silicone	PVC
Body Insulation	Polyamide (Nylon)	
Contact Material	BeCu, Nickel Plt.	
Wire Gauge	18 AWG	
Stranding (# x Diam.)	195 x 0.07 mm	
OD	3.7 mm (.146")	
Length & Color	See How to Order	
Quantity / Pkg	10	

How to Order					
CT2062-L-#	Length cm (-L)				
	-25	-50	-100	-150	-200
	Color (-#)				
	-0 Black	-2 Red	--	--	--
CT2060-L-#	Length cm (-L)				
	-25	-50	-100	--	--
	Color (-#)				
	-0 Black	-2 Red	--	--	--

### 4mm Retractable Sleeve Banana Plug Straight Plug to Straight Plug

Covering sleeve retracts as you plug into the jack. Banana plugs include a grey plastic insulation tip for added user protection.

- IEC 61010-031 rated
- Highly flexible silicone jacketed lead wire
- RoHS (2011/65/EU) compliant

Model	CT3637-L-#
Type	Individual
IEC Rating	600 V CAT II
Current Max	12 A
Jacket Material	Silicone
Body Insulation	Polyamide (Nylon)
Contacts Material	BeCu, Nickel Plt.
Wire Gauge	18 AWG
Stranding (# x Diam.)	195 x 0.07 mm
OD	3.7 mm (.146")
Length & Color	See How to Order
Quantity / Pkg	10

How to Order			
CT3637-L-#	Length cm (-L)		
	-100	-150	-200
	Color (-#)		
	-0 Black	-2 Red	--

# Banana Plugs

## Test Leads



CT3752-100



CT3751-100-2



CT2162-100-2



CT2485

### 4mm Sheath Banana Plug Straight Plug to Straight Plug

Fixed sheath for highest user protection.

- IEC 61010-031 rated
- Models CT3751 and CT3752 UL listed
- Highly flexible silicone jacketed lead wire
- RoHS (2011/65/EU) compliant

Model	CT3752-L	CT3751-L-#	CT2485	CT2162-L-#
Type	Set	Individual	Set	Individual
IEC Rating	1,000 V CAT III / 600 V CAT IV		1,000 V CAT IV	
Current Max	10 A		12 A	
UL Listed	Yes		--	--
Jacket Material	Silicone			
Body Insulation	Polyamide (Nylon)			
Contacts Material	BeCu, Nickel Plt.			
Wire Gauge	18 AWG			
Stranding (# x Diam.)	175 x 0.08 mm		195 x 0.07 mm	
OD	4.0 mm (.157")		3.7 mm (.146")	
Length	See How to Order		150 cm (60")	See How to Order
Color	Black & Red	See How to Order	Black & Red	See How to Order
Quantity / Pkg	1 Pair	10	1 Pair	10

How to Order					
CT3752-L	Length cm (-L)				
	--	--	-100	-150	-200
CT3751-L-#	Length cm (-L)				
	--	--	-100	-150	-200
	Color (-#)				
-0 Black	-2 Red	--	--	--	
CT2162-L-#	Length cm (-L)				
	-25	-50	-100	-150	-200
	Color (-#)				
-0 Black	-2 Red	--	--	--	

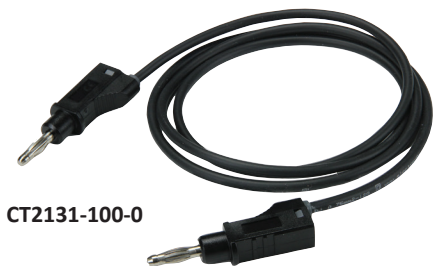

CT2131-100-0



CT2521-100-0

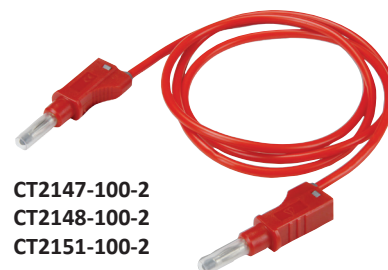

CT2147-100-2  
CT2148-100-2  
CT2151-100-2

### 4mm Stacking Banana Plug Straight Plug to Straight Plug

Stacking banana plugs are available as standard, sheath or retractable. Retractable plugs feature clear covering sleeves that retract as you plug into the jacks and have a grey plastic insulation tip for added user protection.

- IEC 61010-031 rated
- Highly flexible silicone or PVC jacketed wire
- RoHS (2011/65/EU) compliant

Model	CT2131-L-#	CT2521-L-#	CT2148-L-#	CT2151-L-#	CT2147-L-#
Style	Stacking Plug	Stacking Sheath Plug	Stacking Retractable Sheath Plug		
Type	Individual				
IEC Rating	30 VAC / 60 VDC	1,000 V CAT III / 600 V CAT IV	600 V CAT II		
Voltage Max	1,200 VAC / VDC	--	--	--	--
Current Max	12 A		36 A		12 A
Jacket Material	Silicone				PVC
Body Insulation	Polyamide (Nylon)				
Contacts Material	BeCu, Nickel Plt.				
Wire Gauge	18 AWG			13 AWG	18 AWG
Stranding (# x Diam.)	195 x 0.07 mm			651 x 0.07 mm	195 x 0.07 mm
OD	3.7 mm (.146")			3.9 mm (.154")	3.7 mm (.146")
Length & Color	See How to Order				
Quantity / Pkg	10				

How to Order						
CT2131-L-# CT2521-L-#	Length cm (-L)					
	-25	-50	-100	-150	-200	--
	Color (-#)					
	-0 Black	-2 Red	--	--	--	--
CT2148-L-# CT2151-L-#	Length cm (-L)					
	-25	-50	-100	-150	-200	--
	Color (-#)					
	-0 Black	-2 Red	-4 Yellow	-5 Green	-6 Blue	-9 White
CT2147-L-#	Length cm (-L)					
	--	-50	-100	--	--	--
	Color (-#)					
	-0 Black	-2 Red	--	--	--	--

# Banana Plugs

## Test Leads



CT3754-100



CT3753-100-0



CT2484  
CT3130  
CT3132



CT2176-100-2

## 4mm Sheath Banana Plug Straight Plug to Right Angle Plug

Most common test lead set (and replacement) for handheld DMMs.  
Right-angle banana plug for the meter and straight banana plug for the probe or clip.

- IEC 61010-031 rated
- Models CT3753 and CT3754 UL listed
- RoHS (2011/65/EU) compliant

Model	CT3754-L	CT3753-L-#	CT2484	CT2176-L-#	CT3130	CT3132
Type	Set	Individual	Set	Individual	Set	
IEC Rating	1,000 V CAT III / 600 V CAT IV					
Current Max	10 A		12 A		20 A	12 A
Jacket Material	Silicone				PVC	Silicone
UL Listed	Yes		--	--	--	--
Body Insulation	Polyamide (Nylon)					
Contacts Material	BeCu, Nickel Plt.					
Wire Gauge	18 AWG				17 AWG	18 AWG
Stranding (# x Diam.)	175 x 0.08 mm		195 x 0.07 mm		259 x 0.07 mm	195 x 0.07 mm
OD	4.0 mm (.157")		3.7 mm (.146")		3.8 mm (.150")	3.7 mm (.146")
Length	See How to Order		150 cm (60")	See How to Order	100 cm (40")	
Color	Black & Red	See How to Order	Black & Red	See How to Order	Black & Red	
Qty / Pkg	1 Pair	10	1 Pair	10	1 Pair	

How to Order			
CT3754-L	Length cm (-L)		
	-100	-150	-200
CT3753-L-#	Length cm (-L)		
	-100	-150	-200
	Color (-#)		
	-0 Black	-2 Red	--
CT2176-L-#	Length cm (-L)		
	-100	-150	-200
	Color (-#)		
	-0 Black	-2 Red	--



CT3803-30



CT3802-30-2



CT3805-30



CT3804-30-0

### 4mm Sheath Banana Plug Sheath Plug to Insulated Alligator Clip

Convenient DMM sheath banana plug to insulated standard alligator clip.

- IEC 61010-031 rated
- RoHS (2011/65/EU) compliant

Model	CT3803-L	CT3802-L-#	CT3805-L	CT3804-L-#
Type	Set	Individual	Set	Individual
One End	Straight Sheath		Right-Angle Sheath	
Other End	Insulated Alligator Clip			
IEC Rating	300 V CAT II			
Current Max	10 A			
Jacket Material	Silicone			
Body Insulation	Polyamide (Nylon)			
Banana Contacts	BeCu, Nickel Pt.			
Alligator Jaws Opens to	.31" (7.9 mm)			
Alligator Clip	Steel, Nickel Pt.			
Wire Gauge	18 AWG			
Stranding (# x Diam.)	175 x 0.08 mm			
OD	4.0 mm (.157")			
Length	See How to Order			
Color	Black & Red	See How to Order	Black & Red	See How to Order
Qty / Pkg	1 Pair	10	1 Pair	10

How to Order			
CT3802-L-#	Length cm (-L)		
	-30	-60	--
	Color (-#)		
	-0 Black	-2 Red	--
CT3803-L	Length cm (-L)		
	-30	-60	--
	Length cm (-L)		
CT3804-L-#	-30	-60	-100
	Color (-#)		
	-0 Black	-2 Red	--
	Length cm (-L)		
CT3805-L	-30	-60	-100



## Test Lead Wires

Our quality test lead wire is ideal for building do-it-yourself test leads, patch cords and test fixtures. Wires feature highly stranded copper conductors with soft silicone or PVC jackets for high flexibility, and double layers for safety and durability. All conform to IEC61010-031.

Available from 2 A to 36 A in three convenient lengths: 10, 50, and 100 m and in 6 colors. Test Lead Wire Racks are offered for storing and organizing your Test Leads.

Silicone and PVC Jacketed .....	75
Test Lead Racks.....	76



## Silicone & PVC Jacket

### Silicone Jacketed

Ideal test lead wire for building Do-It-Yourself (DIY) test leads, patch cords, and test fixtures. Silicone is the best test lead jacket material, combining high flexibility, even at low temperatures, with resistance to burns and chemicals. The conductor is highly stranded soft bare copper for additional flexibility.

- IEC 61010-031 rated
- Meets the safety requirements of IEC 61010-031
- Available in 6 colors: black, red, yellow, green, blue and white
- Available in 3 lengths: 10 m, 50 m & 100 m
- RoHS (2011/65/EU) compliant



Model	CT2956-#-L	CT2883-#-L	CT2884-#-L	CT2799-#-L	CT2957-#-L	CT2885-#-L	CT2844-#-L
IEC Rating	1,000 V CAT III / CAT IV						
Current Max	2 A	6 A	10 A	12 A	20 A	25 A	36 A
Jacket Material	Silicone						
Conductor Area	0.22 mm <sup>2</sup>	0.40 mm <sup>2</sup>	0.50 mm <sup>2</sup>	0.75 mm <sup>2</sup>	1.00 mm <sup>2</sup>	1.50 mm <sup>2</sup>	2.50 mm <sup>2</sup>
Wire Gauge	23 AWG	21 AWG	20 AWG	18 AWG	17 AWG	15 AWG	13 AWG
Stranding (# x Diam.)	56 x 0.07 mm	104 x 0.07 mm	130 x 0.07 mm	195 x 0.07 mm	259 x 0.07 mm	392 x 0.07 mm	651 x 0.07 mm
OD	1.4 mm (.055")	2.1 mm (.083")	2.7 mm (.106")	3.7 mm (.146")		3.8 mm (.150")	3.9 mm (.154")
Color & Length	See How to Order at bottom of page						

### PVC Jacketed

PVC jacketed test lead wire is the choice for cost effective, high quality test leads and patch cords. The jacket features a durable colored outer layer with an inner white layer for cut or wear visibility. The conductor is highly stranded soft bare copper for additional flexibility.

- IEC 61010-031 rated
- Meets the safety requirements of IEC 61010-031
- Available in 6 colors: black, red, yellow, green, blue and white
- Available in 3 lengths: 10 m, 50 m & 100 m
- RoHS (2011/65/EU) compliant



Model	CT2878-#-L	CT2879-#-L	CT2837-#-L	CT2880-#-L	CT2881-#-L	CT2882-#-L
IEC Rating	1,000 V CAT III / CAT IV					
Current Max	6 A	10 A	12 A	20 A	25 A	36 A
Jacket Material	PVC					
Conductor Area	0.40 mm <sup>2</sup>	0.50 mm <sup>2</sup>	0.75 mm <sup>2</sup>	1.00 mm <sup>2</sup>	1.50 mm <sup>2</sup>	2.50 mm <sup>2</sup>
Wire Gauge	21 AWG	20 AWG	18 AWG	17 AWG	15 AWG	13 AWG
Stranding (# x Diam.)	104 x 0.07 mm	130 x 0.07 mm	195 x 0.07 mm	259 x 0.07 mm	392 x 0.07 mm	651 x 0.07 mm
OD	2.0 mm (.079")	2.7 mm (.106")	3.7 mm (.146")	3.8 mm (.150")		3.9 mm (.154")
Color & Length	See How to Order at bottom of page					

#### How to Order

Model-#-L	Color (-#)					
	-0 Black	-2 Red	-4 Yellow	-5 Green	-6 Blue	-9 White
	Length m (-L)					
	-10	-50	-100	--	--	--

# Test Lead Wires

## Test Lead Racks

CT3273



CT2051

### Wire Racks, Wall

- Wall mounted
- Mounting hardware included
- RoHS (2011/65/EU) compliant

Model	CT3273	CT2051
Capacity (approx.)	50 Test Leads	60 Test Leads
Style	Fixed	Adjustable
Rack Configuration	13 slots (in 3 widths): 2 Wide slots 5.8 mm (.23") 2 Narrow slots 2.8 mm (.11") 9 Medium slots 4.2 mm (.17")	Rail: 35 cm (14") Wide; 18 Adjustable Plastic Hooks may be positioned as needed
Material	Steel, Black	Aluminum Rail with Plastic Hooks



CT3274  
CT3275

### Wire Racks, Rolling

Suitable for laboratories or classrooms, our smooth rolling test lead racks provide stable and portable storage. The central storage tray is height adjustable and features either 100 or 200 test lead capacity.

- 5-caster base
- Height adjustable
- Central storage tray
- Some assembly required
- RoHS (2011/65/EU) compliant

Model	CT3274	CT3275
Capacity (approx.)	100 Test Leads	200 Test Leads
# of Racks (CT3273)	2	4
Central Tray	Plastic, Grey 14.6" x 10.6" x 4.1" (370 x 270 x 105 mm)	
Height Adjustable	39" - 71" (1 - 1.8 m)	



# Kits

Cal Test Electronics offers a selection of instrument accessory kits that incorporate the most commonly needed items into a single package. Each kit has been designed around a specific test instrument and contains a selection of products so that you can quickly conduct performance, verification or calibration tests.

Power Supply.....	78
Function Generator and Frequency Counter .....	79
Spectrum Analyzer .....	80
Oscilloscope.....	81
Digital Multimeter .....	82-87

## Power Supply



CT3375A



CT3376A



CT3374A

### Power Supply Kits

Three convenient kits providing the leads and adapters to connect your AC or DC bench power supply.

- IEC 61010-031 rated accessories
- RoHS (2011/65/EU) compliant
- Packaged in clear clamshell blister

Model	CT3374A	CT3375A	CT3376A
<b>Description</b>	6-Piece Kit	12-Piece Kit	15-Piece Kit
<b>Typically Used By</b>	Technician	Senior Technician	Engineer
<b>Grade</b>	Basic	Enhanced	Advanced
<b>Current Max</b>	10 A	10 A	36 A
<b>Components</b>	<b>Kit Contains</b>		
Lead 4 mm Banana, Stacking Retractable, Sheath, Plug to Plug, Silicone Jacketed Wire, 18 AWG, Length 100 cm (40")	2 (1 Black, 1 Red)	2 (1 Black, 1 Red)	--
Lead 4 mm Banana, Stacking Retractable, Sheathed, Plug to Plug, Silicone Jacketed Wire, 13 AWG, Length 100 cm (40")	--	--	3 (1 Black, 1 Red, 1 Green)
Lead Insulated Mini Crocodile Clips, PVC Jacketed Wire, 20 AWG, Length 200 cm (80")	--	2 (1 Black, 1 Red)	--
Adapter 6 mm Spade to 4 mm Jack	2 (1 Black, 1 Red)	4 (2 Black, 2 Red)	6 (2 Black, 2 Red, 2 Green)
Medium Insul. Alligator Clip w/ 4 mm Jack	2 (1 Black, 1 Red)	2 (1 Black, 1 Red)	--
Extra Large Insul. Alligator Clip w/ 4 mm Jack	--	2 (1 Black, 1 Red)	3 (1 Black, 1 Red, 1 Green)
Adapter BNC female to 4 mm Banana Plugs	--	--	1 (Black)
Adapter BNC male to 4 mm Banana Posts	--	--	1 (Black)
Cable Assembly BNC male RG-58C/U, 100 cm (40")	--	--	1 (Black)

Function Generator & Frequency Counter



CT3733



CT3734



CT3735



CT3736

Function Generator and Frequency Counter Interconnect Kits

These kits provide the required cables and adapters for using effectively your instrument. Standard interconnect components will work with all major instrument models.

- RoHS (2011/65/EU) compliant
- Packaged in clear clamshell blister

Model	CT3733	CT3734	CT3735	CT3736
<b>Description</b>	4-Piece Kit	4-Piece Kit	6-Piece Kit	9-Piece Kit
<b>Typically Used By</b>	Technician	Technician	Senior Technician	Engineer
<b>For Frequency Counters</b>		x		
<b>For Function Generators</b>	x		x	
<b>For Arbitrary Generators</b>				x
<b>Connector Grade</b>	General Purpose			
<b>Impedance</b>	50 Ω			
<b>Components</b>	<b>Kit Contains</b>			
Coaxial Cable, BNC male, 50 Ω, RG-58C/U, Length 100 cm (40")	1	2	1	2
Coaxial Cable, BNC male to IC Clips (1 Black & 1 Red), 50 Ω, RG-58C/U, Length 100 cm (40")	1	--	1	1
Tee Adapter, BNC female-male-female, 50 Ω	1	1	1	1
Adapter, BNC female to N male, 50 Ω	--	1	1	1
Adapter, BNC female to 4 mm Banana Plug	1	--	1	2
Attenuator, BNC male-female, 50 Ω, 20 dB, 4 GHz, 2 W	--	--	--	1
Feed-Thru Terminator, BNC male-female, 50 Ω, 2 W 1%	--	--	1	1

## Spectrum Analyzer



### Spectrum Analyzer Kits

Three spectrum analyzer kits to choose from. Model CT3739 and CT3740 have the most common coax cables and adapters for use with spectrum analyzers up to 3 GHz. Model CT3741 provides an advanced selection of coaxial adapters, cables and attenuators for higher performance 9 GHz spectrum analyzers.

- RoHS (2011/65/EU) compliant
- Packaged in clear clamshell blister

Model	CT3739	CT3740	CT3741
<b>Description</b>	9-Piece Kit	10-Piece Kit	9-Piece Kit
<b>Typically Used By</b>	Technician	Senior Technician	Engineer
<b>For Spectrum Analyzers up to</b>	3 GHz		9 GHz
<b>Grade</b>	General Purpose		Advanced
<b>Impedance</b>	50 Ω		
<b>Components</b>	<b>Kit Contains</b>		
Coaxial Cable, BNC male, 50 Ω, RG-58C/U, Length 100 cm (40")	2	2	1
RF Cable, N male to N male, 50 Ω, 12.4 GHz, Length 100 cm (40")	--	--	1
Tee Adapter, BNC female-male-female, 50 Ω	1	1	1
Adapter, BNC female to N male, 50 Ω	1	1	1
Adapter, BNC female to N female, 50 Ω	1	1	--
Adapter, BNC female to 4 mm Banana Plug	1	1	1
Adapter, BNC female to SMA male, 50 Ω	1	1	--
Adapter, BNC male to N female, 50 Ω	--	--	1
Adapter, BNC male to SMA female, 50 Ω	1	1	--
Adapter, N female to SMA male, 50 Ω	--	--	1
Terminator, BNC male, 50 Ω, +1%, 500 MHz	1	1	1
Attenuator, BNC male to female, 50 Ω, 10 dB, 4 GHz, 2 W	--	1	--
Attenuator, N male to female, 50 Ω	--	--	1



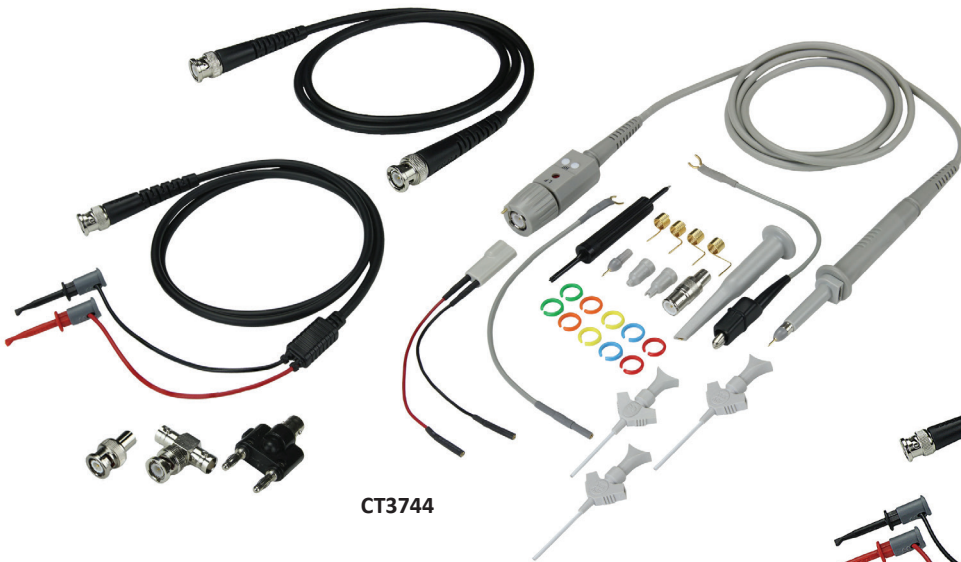

CT3744



CT3743

### Oscilloscope Adapter Kits

Three kits containing the most popular and commonly used cables and adapters to connect your oscilloscope with other test instruments or circuits. Model CT3742 is a basic interconnection kit; Model CT3743 includes a 100 MHz switchable 1x/10x oscilloscope probe, and Model CT3744 includes a 500 MHz 10x fixed oscilloscope probe with an enhanced accessory kit.

- IEC 61010-031 rated accessories
- RoHS (2011/65/EU) compliant
- Packaged in clear clamshell blister

Model	CT3742	CT3743	CT3744
Typically Used By	Technician	Senior Technician	Engineer
Description	5-Piece Kit	6-Piece Kit	6-Piece Kit
Grade	Basic	Enhanced	Advanced
Impedance	50 Ω		
Components	Kit Contains		
Coaxial Cable, BNC male, 50 Ω, RG-58C/U, Length 100 cm (40")	1	1	1
Coaxial Cable, BNC male to MiniPro Clips (1 Black, 1 Red), 50 Ω, RG-58C/U, Length 100 cm (40")	1	1	1
Tee Adapter, BNC female-male-female, 50 Ω	1	1	1
Adapter, BNC female to 4 mm Banana Plug	1	1	1
Terminator, BNC male, 50 Ω, ±1%, 500 MHz	1	1	1
Oscilloscope Probe 100 MHz, Switchable x1/x10/R, 1.2 m (CT2674A)	--	1	--
Oscilloscope Probe 500 MHz, Fixed 10x with enhanced probe kit, 1.2 m (CT3288ARA)	--	--	1



CT3742

# Kits

## Digital Multimeter



### Deluxe DMM Kit

Model	CT2300
-------	--------

- IEC 61010-031 rated accessories
- PVC jacketed lead wire
- Replaceable tip probe, 4 mm banana plug tip and 2 mm smooth tip
- Cap on probe body tip provides CAT III rating
- 0.7 mm stainless steel spring tip probe for fine work
- Extra large alligator clips for electrical work
- RoHS (2011/65/EU) compliant
- Packaged in polybag

Kit Contains	
(2) Modular Probes: (1) Black, (1) Red - (CT2268)	
(2) Spring Tip Mini-Probes: (1) Black, (1) Red - (CT2665)	
(2) Banana Test Leads, 4 mm Sheath Plug to Right-Angle Sheath Plug, PVC Jacket, 100 cm (40"): (1) Black, (1) Red - (CT3130)	
(2) Flex Pincer Clips: (1) Black, (1) Red - (CT2487)	
(2) Insulated Alligator Clips, Extra Large: (1) Black, (1) Red - (CT3286)	
(2) Adapters, 4 mm Banana Plug to Banana Jack: (1) Black, (1) Red - (CT3089)	
(2) Adapters, Spade 6 mm to 4 mm Jack: (1) Black, (1) Red - (CT2661)	
Rating	
Modular Probe Bodies	1,000 V CAT III w/cap, (CAT II w/o), 36 A
Spring Tip Probe Bodies	600 V CAT II, 1 A
Test Leads	1,000 V CAT III, 20 A
Flex Pincer Clips	1,000 V CAT II, 6 A
Extra Large Alligator Clips	1,000 V CAT III / 600 V CAT IV, 36 A
Plug Adapters	<30 VAC / <60 VDC, 10 A
Spade Lugs	<30 VAC / <60 VDC, 36 A



**New**

### General Purpose Handheld DMM Kit

Model	CT2696C
-------	---------

- IEC 61010-031 rated accessories
- Cap on probe body tip provides CAT III / CAT IV rating
- Sprung hooks snap-lock to probe bodies
- Silicone jacketed lead wire
- Right-angle 4 mm sheath banana plug for hand-held meter connection
- RoHS (2011/65/EU) compliant
- Packaged in clear PVC pouch

Kit Contains	
(2) Probe Bodies, 2 mm Tip w/Safety Cap: (1) Black, (1) Red - (CT3975)	
(2) Banana Test Leads, 4 mm Sheath Plug to Right-Angle Sheath Plug, Silicone Jacket, 150 cm (60"): (1) Black, (1) Red - (CT3754-150)	
(2) Adapters, Spade 6 mm to 4 mm Jack: (1) Black, (1) Red - (CT2661)	
(2) Sprung Hooks: (1) Black, (1) Red - (CT3947)	
(2) Insulated Alligator Clips, Extra Large: (1) Black, (1) Red - (CT3286)	
Rating	
Probe Bodies	1,000 V CAT III / 600 V CAT IV w/cap, (CAT II w/o), 10 A
Test Leads	1,000 V CAT III, 10 A
Spade Lugs	<30 VAC / <60 VDC, 36 A
Sprung Hooks	300 V CAT II, 3 A
Extra Large Alligator Clips	1,000 V CAT III / 600 V CAT IV, 36 A



**Deluxe Electronic DMM Kit**

Model	CT2622
-------	--------

- IEC 61010-031 rated accessories
- Ideal for high-density circuit testing
- Silicone jacketed lead wire
- Cap on probe body tip provides CAT III rating
- 0.7 mm stainless steel spring tip probe for fine work
- RoHS (2011/65/EU) compliant
- Packaged in clear PVC pouch

Kit Contains	
(2) Probe Bodies, 4 mm Banana Plug Tip: (1) Black, (1) Red - (CT2483)	
(2) Banana Test Leads, 4 mm Sheath Plug to Right-Angle Sheath Plug, Silicone Jacket, 150 cm (60"): (1) Black, (1) Red - (CT2484)	
(2) Spring Tip Mini-Probes, 4 mm Jack: (1) Black, (1) Red - (CT2665)	
(2) MiniFlex Clips to 4 mm Jacks, Silicone 0.40, 10 cm (4"): (1) Black, (1) Red - (CT3096)	
(2) Sprung Hooks: (1) Black, (1) Red - (CT2664)	
Rating	
Probe Bodies	1,000 V CAT III w/cap, (CAT II w/o), 36 A
Spring Tip Probe Bodies	600 V CAT II, 1 A
Test Leads	1,000 V CAT III / 600 V CAT IV, 12 A
MiniFlex Clip Leads	<30 VAC / <60 VDC, 1 A
Sprung Hooks	<30 VAC / <60 VDC, 5 A

**Deluxe Surface Mount DMM Kit**

Model	CT2970
-------	--------

- IEC 61010-031 rated accessories
- 0.7 mm stainless steel spring tip probe for fine work
- Silicone jacketed lead wire
- MiniFlex clips w/rotating pincers
- MicroClip test clips for SMD components
- RoHS (2011/65/EU) compliant
- Packaged in clear PVC pouch

Kit Contains	
(2) Spring Tip Mini-Probes, 4 mm Jack: (1) Black, (1) Red - (CT2665)	
(2) Banana Test Leads, 4 mm Sheath Plug to Right-Angle Sheath Plug, Silicone Jacket, 100 cm (40"): (1) Black, (1) Red - (CT3754-100)	
(2) MiniFlex Test Clips w/ .031" Pins: (1) Black, (1) Red - (CT3101)	
(2) MicroClip Test Clips w/ .031" Pins: (1) Black, (1) Red - (CT3100)	
(2) MicroLeads, 0.031" Jack to 4 mm Jack, Silicone Jacket, 10 cm (4"): (1) Black, (1) Red - (CT3099)	
Rating	
Spring Tip Probe Bodies	600 V CAT II, 1 A
Test Leads	1,000 V CAT III, 10 A
MiniFlex Test Clips	<30 VAC / <60 VDC, 1 A
MicroClip Test Clips	<30 VAC / <60 VDC, 0.5 A
MicroLeads	<30 VAC / <60 VDC, 2 A

## Digital Multimeter



### Replacement DMM Probe Body Accessory Kit

Model	CT3979-150
-------	------------

- IEC 61010-031 rated accessories
- Probe bodies accept 4 mm sheath banana plugs
- Cap on probe tip provides CAT III / CAT IV rating
- Standard 2 mm x 19 mm probe tips
- Silicone jacketed lead wire
- Convenient black and red pairs
- RoHS (2011/65/EU) compliant
- Packaged in ploybag

Kit Contains	
(2) Probe Bodies, 2 mm Tip w/Safety Cap: (1) Black, (1) Red - (CT3975)	
(2) Banana Test Leads, 4 mm Sheath Plug to Right-Angle Sheath Plug, Silicone Jacket, 150 cm (60"): (1) Black, (1) Red - (CT3754-150)	
(2) Sprung Hooks, (1) Black, (1) Red - (CT3947)	
(2) Alligator Clips, (1) Black, (1) Red - (CT3943)	
(2) Spade Lugs, (1) Black, (1) Red - (CT3945)	
(2) Extended Tips, (1) Black, (1) Red - (CT3941)	
Rating	
Probe Bodies	1,000 V CAT III / 600 V CAT IV w/cap, (CAT II w/o), 10 A
Test Leads	1,000 V CAT III, 10 A
Sprung Hooks	300 V CAT II, 3 A
Alligator Clips	300 V CAT II, 5 A
Spade Lugs	<30 VAC / <60 VDC, 5 A
Extended Tips	300 V CAT II, 3 A

### Handheld DMM Probe Lead Accessory Kit

Model	CT3987-120
-------	------------

- IEC 61010-031 rated accessories
- Probe Leads w/ 4 mm right-angle sheath banana plugs
- Cap on probe tip provides CAT III / CAT IV rating
- Standard 2 mm x 19 mm probe tips
- Silicone jacketed lead wire
- Convenient black and red pairs
- RoHS (2011/65/EU) compliant
- Packaged in polybag

Kit Contains	
(2) Probe Leads, 2 mm Tip w/Safety Cap, 4 mm Right-Angle Sheath Plug, Silicone Jacket, 120 cm (48"): (1) Black, (1) Red - (CT3985-120)	
(2) Sprung Hooks, (1) Black, (1) Red - (CT3947)	
(2) Alligator Clips, (1) Black, (1) Red - (CT3943)	
(2) Spade Lugs, (1) Black, (1) Red - (CT3945)	
(2) Extended Tips, (1) Black, (1) Red - (CT3941)	
Rating	
Probe Leads	1,000 V CAT III / 600 V CAT IV w/cap, (CAT II w/o), 10 A
Sprung Hooks	300 V CAT II, 3 A
Alligator Clips	300 V CAT II, 5 A
Spade Lugs	<30 VAC / <60 VDC, 5 A
Extended Tips	300 V CAT II, 3 A



New

**Basic Electrical DMM Kit**

**Model** CT3738C

- IEC 61010-031 rated access
- Silicone jacketed lead wire
- Cap on probe body tip provides CAT III / CAT IV rating
- Alligator clip snap-locks to probe body
- RoHS (2011/65/EU) compliant
- Includes tri-fold nylon pouch



Kit Contains	
(2) Probe Bodies, 2 mm Tip w/Safety Cap: (1) Black, (1) Red - (CT3975)	
(2) Banana Test Leads, 4 mm Sheath Plug to Right-Angle Sheath Plug, Silicone Jacket, 100 cm (40"): (1) Black, (1) Red - (CT3754-100)	
(2) Insulated standard Alligator Clips w/snap-lock retention: (1) Black, (1) Red - (CT3943)	
(1) Tri-Fold Nylon Pouch, Black - (CT3041)	
Rating	
Probe Bodies	1,000 V CAT III / 600 V CAT IV w/cap, (CAT II w/o), 10 A
Test Leads	1,000 V CAT III, 10 A
Insulated Alligator Clips	300 V CAT II, 5 A

**Introductory DMM Probe Body Accessory Kit**

**Model** CT3977-150

- IEC 61010-031 rated accessories
- Probe bodies accept 4 mm sheathed banana plugs
- Standard 2 mm x 19 mm probe tips
- Sprung hooks snap-lock to probe bodies
- Silicone jacketed lead wire
- Cap on probe tip provides CAT III / CAT IV rating
- Convenient black and red pairs
- RoHS (2011/65/EU) compliant
- Packaged in polybag



Kit Contains	
(2) Probe Bodies, 2 mm Tip w/Safety Cap: (1) Black, (1) Red - (CT3975)	
(2) Banana Test Leads, 4 mm Sheath Plug to Right-Angle Sheath Plug, Silicone Jacket, 150 cm (60"): (1) Black, (1) Red - (CT3754-150)	
(2) Sprung Hooks, (1) Black, (1) Red - (CT3947)	
Rating	
Probe Bodies	1,000 V CAT III / 600 V CAT IV w/cap, (CAT II w/o), 10 A
Test Leads	1,000 V CAT III, 10 A
Sprung Hooks	300 V CAT II, 3 A

New

**Electrical DMM Kit**

**Model** CT2621C

- IEC 61010-031 rated accessories
- Cap on probe body tip provides CAT III / CAT IV rating
- Silicone jacketed lead wire
- Extra large alligator clips for electrical work
- RoHS (2011/65/EU) compliant
- Includes tri-fold nylon pouch



Kit Contains	
(2) Probe Bodies, 2 mm Tip w/Safety Cap: (1) Black, (1) Red - (CT3975)	
(2) Banana Test Leads, 4 mm Sheath Plug to Right-Angle Sheath Plug, Silicone Jacket, 150 cm (60"): (1) Black, (1) Red - (CT3754-150)	
(2) Adapters, Spade 6 mm to 4 mm Jack: (1) Black, (1) Red - (CT2661)	
(2) Rigid Alligator Clips: (1) Black, (1) Red - (CT2966)	
(2) Insulated Alligator Clips, Extra Large: (1) Black, (1) Red - (CT3286)	
(1) Tri-Fold Nylon Pouch, Black - (CT3041)	
Rating	
Probe Bodies	1,000 V CAT III / 600 V CAT IV w/cap, (CAT II w/o), 10 A
Test Leads	1,000 V CAT III, 10 A
Spade Lugs	<30 VAC / <60 VDC, 36 A
Rigid Alligator Clips	1,000 V CAT III, 20 A
Extra Large Alligator Clips	1,000 V CAT III / 600 V CAT IV, 36 A

# Kits

## Digital Multimeter



### Surface Mount DMM Kit

Model	CT2843
-------	--------

- IEC 61010-031 rated accessories
- Extended probe bodies w/ sharp stainless steel tips
- Silicone jacketed lead wire
- RoHS (2011/65/EU) compliant
- Packaged in polybag

Kit Contains	
(2) Slim-Line Probe Bodies w/Fine Stainless Steel Tip: (1) Black, (1) Red - (CT2662)	
(2) Banana Test Leads, 4 mm Sheath Plug to Right-Angle Sheath Plug, Silicone Jacket, 150 cm (60"): (1) Black, (1) Red - (CT2484)	
Rating	
Extended Probe Bodies	1,000 V CAT IV, 16 A
Test Leads	1,000 V CAT III, 12 A



### Basic DMM Kit

Model	CT2299
-------	--------

- IEC 61010-031 rated accessories
- PVC jacketed lead wire
- Replaceable tip probe, 4 mm banana plug tip and 2 mm smooth tip
- Cap on probe body tip provides CAT III rating
- RoHS (2011/65/EU) compliant
- Packaged in polybag

Kit Contains	
(2) Modular Probes: (1) Black, (1) Red - (CT2268)	
(2) Banana Test Leads, 4 mm Sheath Plug to Right-Angle Sheath Plug, PVC Jacket, 100 cm (40"): (1) Black, (1) Red - (CT3130)	
(2) Flex Pincer Clips: (1) Black, (1) Red - (CT2487)	
Rating	
Probe Bodies	1,000 V CAT III w/cap, (CAT II w/o), 36 A
Test Leads	1,000 V CAT III, 20 A
Flex Pincer Clips	1,000 V CAT II, 6 A



### Bench DMM Probe Lead Accessory Kit

Model	CT3983-120
-------	------------

- IEC 61010-031 rated accessories
- Probe leads w/ 4 mm straight sheath banana plugs
- Cap on probe tip provides CAT III / CAT IV rating
- Standard 2 mm x 19 mm probe tips
- Silicone jacketed lead wire
- Convenient black and red pairs
- RoHS (2011/65/EU) compliant
- Packaged in polybag

Kit Contains	
(2) Probe Leads, 2 mm Tip w/Safety Cap, 4 mm Stright Sheath Plug, Silicone Jacket, 120 cm (48"): (1) Black, (1) Red - (CT3981-120)	
(2) Sprung Hooks, (1) Black, (1) Red - (CT3947)	
(2) Alligator Clips, (1) Black, (1) Red - (CT3943)	
(2) Spade Lugs, (1) Black, (1) Red - (CT3945)	
(2) Extended Tips, (1) Black, (1) Red - (CT3941)	
Rating	
Probe Leads	1,000 V CAT III / 600 V CAT IV w/cap, (CAT II w/o), 10 A
Sprung Hooks	300 V CAT II, 3 A
Alligator Clips	300 V CAT II, 5 A
Spade Lugs	<30 VAC / <60 VDC, 5 A
Extended Tips	300 V CAT II, 3 A





New

**General Purpose Bench DMM Kit**

Model	CT2695C
-------	---------

- IEC 61010-031 rated accessories
- Cap on probe body tip provides CAT III / CAT IV rating
- Sprung hooks snap-lock to probe bodies
- Silicone jacketed lead wire
- Straight 4 mm sheath banana plugs for bench meters
- Extra large alligator clips
- RoHS (2011/65/EU) compliant
- Packaged in clear PVC pouch

Kit Contains	
(2) Probe Bodies, 2 mm Tip w/Safety Cap: (1) Black, (1) Red - (CT3975)	
(2) Banana Test Leads, 4 mm Sheath Plug to Sheath Plug, Silicone Jacket, 150 cm (60"): (1) Black, (1) Red - (CT3752-150)	
(2) Adapters, Spade 6 mm to 4 mm Jack: (1) Black, (1) Red - (CT2661)	
(2) Sprung Hooks: (1) Black, (1) Red - (CT3947)	
(2) Insulated Alligator Clips, Extra Large: (1) Black, (1) Red - (CT3286)	
Rating	
Probe Bodies	1,000 V CAT III / 600 V CAT IV w/cap, (CAT II w/o), 10 A
Test Leads	1,000 V CAT III, 10 A
Spade Lugs	<30 VAC / <60 VDC, 36 A
Sprung Hooks	300 V CAT II, 3 A
Extra Large Alligator Clips	1,000 V CAT III / 600 V CAT IV, 36 A



**Deluxe Bench DMM Kit**

Model	CT3377
-------	--------

- IEC 61010-031 rated accessories
- 0.7 mm stainless steel spring tip probe for fine work
- Silicone jacketed lead wire
- Extra test leads for meter calibration process
- SMD test tweezers for detailed work
- RoHS (2011/65/EU) compliant
- Packaged in clear clamshell blister

Kit Contains	
(2) Spring Tip Mini-Probes, 4 mm Jack: (1) Black, (1) Red - (CT2665)	
(4) Banana Test Leads, 4 mm Sheath Plug to Sheath Plug, Silicone Jacket, 100 cm (40"): (2) Black, (2) Red - (CT3132)	
(1) Adapter, Insulated BNC male to 4 mm Safety Jack - (CT2412)	
(2) Adapters, 4 mm Banana Plug to Jack: (1) Black, (1) Red - (CT3089)	
(2) MiniFlex Clips to 4 mm Jacks, Silicone Jacket, 10 cm (4"): (1) Black, (1) Red - (CT3096)	
(2) Adapters, Spade 6 mm to 4 mm Jack: (1) Black, (1) Red - (CT2661)	
(2) Leads, MiniPro Clips to 4 mm Jacks, PVC Jacket, 10 cm (4"): (1) Black, (1) Red - (CT3280)	
(1) Tweezer Test Lead Set, 4 mm Plug - (CT2301)	
Rating	
Spring Tip Probe Bodies	600 V CAT II, 1 A
Test Leads	1,000 V CAT III / 600 V CAT IV, 12 A
BNC Adapter	500 V CAT 0, 3 A
Plug Adapters	<30 VAC / <60 VDC, 10 A
MiniFlex Clip Leads	<30 VAC / <60 VDC, 1 A
Spade Lugs	<30 VAC / <60 VDC, 36 A
MiniPro Clip Leads	<30 VAC / <60 VDC, 6 A
Tweezer Test Lead Set	400 Vrms, 2 A

## Banana Plug 101

Since its introduction over 90 years ago, the banana plug connector has become the standard single wire connection device for electronic and electrical test equipment. The plug has evolved into a high quality copper alloy contact spring that plugs into a 4 mm (.157") diameter banana jack (socket). The standard spacing for two banana jacks side-by-side is 19.06 mm (.75").

With the introduction of safety standards in the 1980's, banana plugs acquired a cover sheath over the exposed metal contact to enhance user protection. The current international safety standard, IEC 61010-031, *Safety requirements for electrical equipment for measurement, control and lab use – Part 031: Safety requirements for hand-held probe assemblies for electrical measurement and test*, defines dimensions of sheath banana plugs for measurement categories II, III or IV up to 1,000 V.

General dimensions for 4 mm banana plugs and jacks:

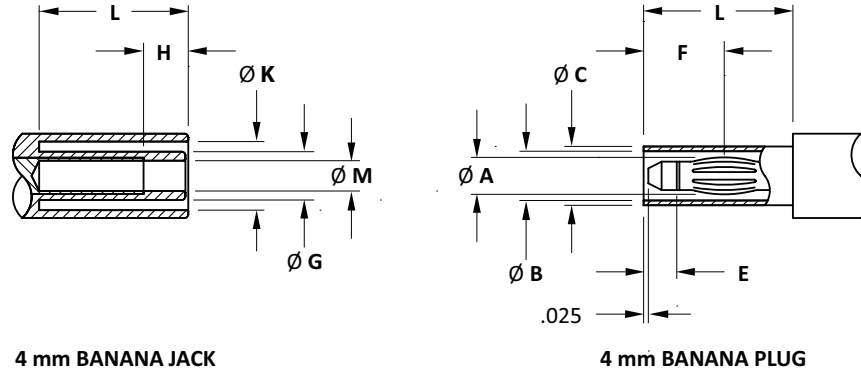

4 mm BANANA JACK

4 mm BANANA PLUG

### Dimensions Key:

A =  $\varnothing .154 \pm .002$  ( $\varnothing 3.90 \text{ mm} \pm .05 \text{ mm}$ ) – Compressed

B  $\geq \varnothing .26$  ( $\varnothing 6.6 \text{ mm}$ )

C  $\leq \varnothing .31 \text{ mm}$  ( $\varnothing 7.9 \text{ mm}$ )

$.10 \leq E \leq .24$  ( $2.6 \text{ mm} \leq E \leq 6 \text{ mm}$ )

F  $\leq .47$  (12 mm) – Center of contact point

G  $\leq \varnothing .25$  ( $\varnothing 6.4 \text{ mm}$ )

$.16 \leq H \leq .24$  ( $4 \text{ mm} \leq H \leq 6 \text{ mm}$ )

K  $\geq \varnothing .32$  ( $\varnothing 8.1 \text{ mm}$ )

L  $\geq .79$  (20 mm)

M =  $\varnothing .157 \pm .002$  ( $\varnothing 4 \text{ mm} \pm .05 \text{ mm}$ )

– For E and H, minimum values with plastic tip, other wise spacing shall be at least .10" (2.6 mm)

– Tolerance on dimensions not otherwise noted:  $\pm .004$  (0.1 mm)

### Measurement Categories:

(Per IEC 61010-031)

Measurement categories are based on location as related to the mains supply where measurement can be made.

**0 (no category)** – circuits that are not directly connected to mains.

*Examples are automobiles or other battery operated circuits or devices.*

**Category II – (CAT II)** – applicable to circuits connected directly to sockets outlets of the low-voltage mains.

*Examples are consumer appliances, power tools, or the consumer side of socket outlets.*

*Typical short circuit currents: < 10 kA*

**Category III – (CAT III)** – applicable to circuits connected to the distribution part of a building's low-voltage mains.

*Examples are power distribution boards, solar cell power assemblies, circuit boxes, circuit breakers, switches and industrial equipment.*

*Typical short circuit currents: > 10 kA*

**Category IV – (CAT IV)** – applicable to circuits connected at the source of the building's low-voltage mains.

*Examples are measurements on devices installed before the main fuse or circuit breaker in a building.*

*Typical short circuit currents: > 50 kA*

*These are high energy circuits so great precautions must be taken while working with these.*

The measurement category of a combination of probe, lead and or accessory is the lower of their respective category ratings.

Within the scope of IEC 61010-031 there are four defined probe assembly types that include banana plugs. The types are A, B, C & D with banana plugs falling under types A and D.

**Type A:** Non-attenuating assemblies rated for direct connection to voltages exceeding 30 Vrms / 42.4 Vpeak / 60 VDC.

**Type D:** Non-attenuating assemblies rated for direct connection to voltages not exceeding 30 Vrms / 42.4 Vpeak / 60 VDC.

Below are descriptions of the most common banana plugs.

### Banana Plug (Type D)

Features an exposed compliant contact spring and an insulation housing. It plugs into both standard and safety 4 mm banana jacks. Although it can operate at much high voltages, the plug is not recommended for handheld use above 30 VAC / 60 VDC (IEC 61010-031) as the exposed contact is capable of rendering an electric shock.

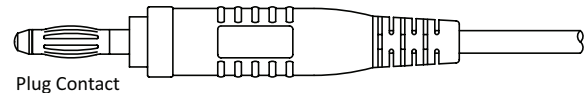

### Stacking Banana Plug (Type D)

Has a banana plug on one end and a banana jack (receptacle) on the other end of its insulated housing. This allows another banana plug to share the same test point.

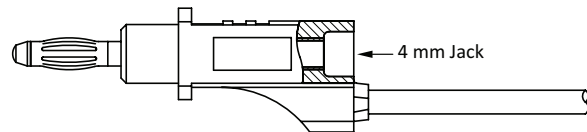

### Sheath Banana Plug (Type A)

Also known as a shrouded, sleeved or safety banana plug. It features a fixed protective sheath over the spring contact that prevents unintentional contact. This plug only fits into safety banana jacks, which feature a recessed ring around their connection jack. This plug is recommended for all CAT III and IV applications.

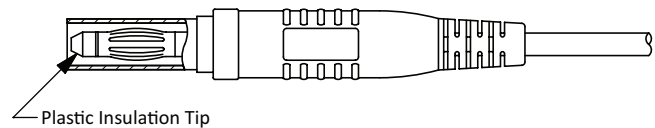

### Stacking Sheath Banana Plug (Type A)

Similar to the stacking banana plug, the plug features a sheath banana plug on one end and a safety banana jack on the other. Recommended for all CAT III and IV applications.

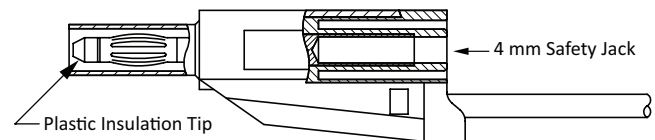

### Retractable Sheath Banana Plugs (Type A)

Feature a spring-loaded protective plastic sheath that prevents unintentional contact yet slides back when engaging a banana jack. An insulator tip on the plug's contact provides further user protection. Retractable sheath banana plugs are for CAT II applications.

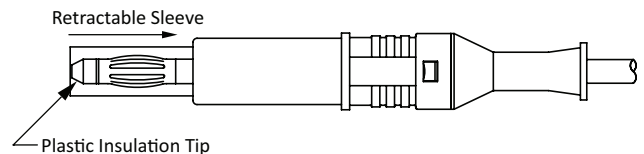

### Stacking Retractable Sheath Banana Plug (Type A)

As with the other stacking banana plugs, it features a plug and a female jack in its housing. But, the retractable sleeve over the plug makes it one of the most versatile banana plugs available, usable with all types of banana jacks. Retractable sheath banana plugs are for CAT II applications.

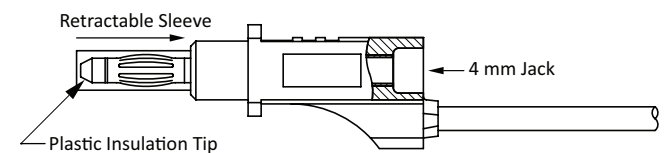

• IEC is a registered trademark of the International Electrotechnical Commission.

# Index

Model No.	Page	Model No.	Page	Model No.	Page	Model No.	Page	Model No.	Page
CP6220	22	CT2401	38	CT2710	20	CT2919	62	CT3195	33
CP6550	22	CT2405A	46	CT2711A	20	CT2939	49	CT3196	33
CP6770	22	CT2410	50	CT2712A	20	CT2940	49	CT3197B	15
CP6990	22	CT2411	51	CT2713A	20	CT2941	50	CT3201	68
CT2002	65	CT2412	50	CT2714	20	CT2942	56	CT3201-S	68
CT2011	65	CT2417	56	CT2715	20	CT2944	7, 55	CT3202	68
CT2013	65	CT2473	29	CT2758	52	CT2956	75	CT3202W	68
CT2015	68	CT2483	27	CT2759	52	CT2957	75	CT3203	67
CT2016	65	CT2484	72	CT2760	52	CT2960A	15	CT3203-S	67
CT2017	68	CT2485	70	CT2761	52	CT2961A	15	CT3204	67
CT2051	76	CT2487	38	CT2762	48	CT2962A	15	CT3204W	67
CT2060	69	CT2488	39	CT2763	48	CT2965	39	CT3205	66
CT2062	69	CT2489	38	CT2765	51	CT2966	39	CT3205W	66
CT2131	71	CT2490A	37	CT2766	51	CT2970	83	CT3206	67
CT2147	71	CT2521	71	CT2771	48	CT2982B	15	CT3206W	67
CT2148	71	CT2551	44	CT2789A	25	CT2985	50	CT3207	59
CT2151	71	CT2553	29	CT2799	75	CT2987	45	CT3207W	59
CT2162	70	CT2575	62	CT2830	60	CT2988	28	CT3208	33
CT2176	72	CT2576	27	CT2837	75	CT2989	66	CT3209	33
CT2213	59	CT2592	44	CT2838A	20	CT2989-S	66	CT3210	33
CT2215	59	CT2593-1	8	CT2840RA	16	CT3041	29	CT3211	33
CT2220	63	CT2593-2	8	CT2841A	17	CT3089	29	CT3212	33
CT2224	63	CT2621C	85	CT2843	86	CT3096	44	CT3217	45
CT2228	63	CT2622	83	CT2844	75	CT3099	42	CT3218	45
CT2230	63	CT2631	67	CT2845	42	CT3100	42	CT3230	57
CT2232	63	CT2631-S	67	CT2846	42	CT3101	44	CT3249	65
CT2234	63	CT2661	29	CT2847	42	CT3130	72	CT3250	66
CT2236	60	CT2662	28	CT2848	43	CT3132	72	CT3251	37
CT2238	60	CT2663	29	CT2850	17	CT3133	16	CT3264	57
CT2240	60	CT2664	27	CT2870	42	CT3133RA	16	CT3269	57
CT2242	60	CT2665	28	CT2878	75	CT3134	59	CT3270	57
CT2243	61	CT2666A	26	CT2879	75	CT3134-S	59	CT3273	76
CT2244	61	CT2667	60	CT2880	75	CT3145	33	CT3274	76
CT2245	61	CT2674A	17	CT2881	75	CT3146	33	CT3275	76
CT2246A	60	CT2675A	17	CT2882	75	CT3149	62	CT3276	65
CT2247	62	CT2676A	16	CT2883	75	CT3150	62	CT3277SA	17
CT2248	29	CT2676ARA	16	CT2884	75	CT3151	62	CT3280	46
CT2264	28	CT2678	16	CT2885	75	CT3151SP	62	CT3286	37
CT2265	27	CT2695C	87	CT2887	42	CT3158	57	CT3288RA	16
CT2266	28	CT2696C	82	CT2900A	25	CT3160	66	CT3288ARA	16
CT2268	27	CT2700	26	CT2904	60	CT3161	50	CT3290RA	13
CT2299	86	CT2701A	53	CT2906	60	CT3180	45	CT3290RA-PRO	13
CT2300	82	CT2702A	53	CT2908	60	CT3183	46	CT3312	51
CT2301	45	CT2703	17	CT2910	60	CT3184-CC	46	CT3313	51
CT2388	28	CT2704	17	CT2911	61	CT3185	46	CT3320	49
CT2392A	37	CT2704SA	17	CT2912	61	CT3187	46	CT3321	49
CT2394	36	CT2707	16	CT2913	61	CT3188	46	CT3322	49
CT2399	38	CT2708	20	CT2914	61	CT3189	33	CT3328	48
CT2400	39	CT2709A	20	CT2915	61	CT3194	33	CT3330	56

Model No.	Page	Model No.	Page	Model No.	Page	Model No.	Page	Model No.	Page
CT3331	56	CT3654	14	CT3752	70	CT3978	31	CTM-34	35
CT3333	56	CT3655	14	CT3753	72	CT3979	84	CTM-34C	35
CT3334	55	CT3659	43	CT3754	72	CT3980	26	CTM-46A	40
CT3340	49	CT3661	14	CT3755	39	CT3981	26	CTM-60	35
CT3341	51	CT3662	21	CT3756	39	CT3982	26	CTM-60C	35
CT3346	48	CT3667	14	CT3759	39	CT3983	86	CTM-60CS	35
CT3348	48	CT3668	20	CT3760	39	CT3984	25	CTM-60S	35
CT3350	52	CT3669	21	CT3761	39	CT3985	25	CTM-60TBO	35
CT3351	52	CT3672	14	CT3762	39	CT3986	25	CTM-60U	35
CT3353	55	CT3673	53	CT3775	27	CT3987	84	CTM-60X	35
CT3369A	54	CT3674	53	CT3776	27	CT3994	31	CTM-62	35
CT3374A	78	CT3675	14	CT3802	73	CT3997	32	CTM-63	36
CT3375A	78	CT3676	14	CT3803	73	CT3998	32	CTM-63C	36
CT3376A	78	CT3677	14	CT3804	73	CT3999	32	CTM-65	37
CT3377	87	CT3678	14	CT3805	73	CT4024	15	CTM-652	37
CT3382A	55	CT3679	21	CT3809	36	CT4025	15	CTM-75K	41
CT3387	48	CT3681	10	CT3810	36	CT4026	15	CTM-78K	41
CT3388	52	CT3683	10	CT3823	21	CT4028	15	CTM-8681	41
CT3389	49	CT3684	12	CT3888	50	CT4068	9	CTM-8783	41
CT3390	49	CT3685	12	CT3889	50	CT4076	11	GE1501	18
CT3391	49	CT3686	8	CT3940	30	CT4078	11	GE1511	18
CT3396	56	CT3687	8	CT3941	30	CT4079	11	GE1511RA	18
CT3407	33	CT3688	12	CT3942	30	CT4121	7	GE1521	18
CT3408	33	CT3723	10	CT3943	30	CT4122	7	GE1521SA	18
CT3438	37	CT3733	79	CT3944	30	CT4123	7	GE2501	18
CT3441	37	CT3734	79	CT3945	30	CTM-21APN	40	GE2511	18
CT3449	37	CT3735	79	CT3946	30	CTM-21CPN	40	GE2511RA	18
CT3637	69	CT3736	79	CT3947	30	CTM-23	40	GE2521	18
CT3645	14	CT3738C	85	CT3948	31	CTM-25	40	GE3121	19
CT3646	14	CT3739	80	CT3955	23	CTM-26	40	GE3125	19
CT3647	14	CT3740	80	CT3956	23	CTM-27	40	GE3225	19
CT3648	21	CT3741	80	CT3957	23	CTM-29	40	GE3231	19
CT3649	14	CT3742	81	CT3974	30	CTM-30	35	GE3421	19
CT3650	14	CT3743	81	CT3975	30	CTM-30BL	35	GE3425	19
CT3652	14	CT3744	81	CT3976	31	CTM-30C	35	GE4511RA	18
CT3653	14	CT3751	70	CT3977	85	CTM-30TBO	35		





Cal Test Electronics, Inc.  
22820 Savi Ranch Parkway  
Yorba Linda, CA 92887  
Phone: 800-572-1028 ■ 714-221-9330  
Fax: 714-921-9849 ■ [caltestelectronics.com](http://caltestelectronics.com)



## X-ON Electronics

Largest Supplier of Electrical and Electronic Components

*Click to view similar products for [Test Plugs & Test Jacks](#) category:*

*Click to view products by [Cal Test](#) manufacturer:*

Other Similar products are found below :

[579-0400](#) [66000-7](#) [R644543000](#) [R921923000](#) [R921930000](#) [R941344000](#) [R948161000](#) [R999351000](#) [1408-4](#) [1533-1](#) [174-R825B-EX](#)  
[NYS508-BU](#) [1680](#) [174-R819B-EX](#) [R644543003](#) [R644543004](#) [R644543020](#) [R644543021](#) [R921926000](#) [R921931000](#) [R921932000](#)  
[R921934000](#) [R929991000](#) [R941460000](#) [R941461000](#) [R941463600](#) [R941920600](#) [R948160000](#) [31B-2-RED](#) [032-0016-023](#) [105-1106-001](#)  
[108-1000-106](#) [108-2301-621](#) [66001-9](#) [7013](#) [1395080-1](#) [930166100](#) [NYS508-W](#) [NYS508-Y](#) [NYS511-R](#) [BP30-2BR10-B PKG](#) [BP30-10-WT](#)  
[BP30-2BR-B PKG](#) [BP30Y-1 PKG](#) [R941049000](#) [R941340000](#) [R948141029](#) [R921922000](#) [R644543022](#) [R948142000](#)