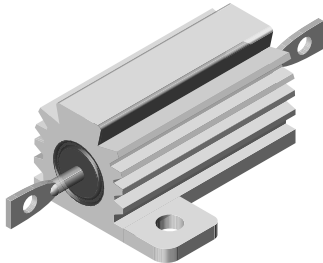

Wirewound Resistors, Military, MIL-PRF-18546 Qualified, Type RE, Aluminum Housed, Chassis Mount

FEATURES

- Molded construction for total environmental protection
- Complete welded construction
- Qualified to MIL-PRF-18546
- Available in non-inductive styles (type N) with Ayrton-Perry winding for lowest reactive components
- Mounts on chassis to utilize heat-sink effect
- Excellent stability in operation (< 1 % change in resistance)

STANDARD ELECTRICAL SPECIFICATIONS

| MILITARY MODEL | VISHAY REFERENCE MODEL | POWER RATING $P_{25\text{ }^\circ\text{C}}$ W | RESISTANCE RANGE Ω | TOLERANCE $\pm \%$ | WEIGHT (typical) g |
|----------------|------------------------|---|------------------------------|-----------------------|-----------------------|
| RE60G | RH005 | 5 | 0.10 to 3.32K | 1 | 3 |
| RE60N | NH005 | 5 | 1.0 to 1.65K | 1 | 3.3 |
| RE65G | RH010 | 10 | 0.10 to 5.62K | 1 | 6 |
| RE65N | NH010 | 10 | 1.0 to 2.8K | 1 | 8.8 |
| RE70G | RH025 | 20 | 0.10 to 12.1K | 1 | 13 |
| RE70N | NH025 | 20 | 1.0 to 6.04K | 1 | 16.5 |
| RE75G | RH050 | 30 | 0.10 to 39.2K | 1 | 28 |
| RE75N | NH050 | 30 | 1.0 to 19.6K | 1 | 35 |
| RE77G | RH100 | 75 | 0.05 to 29.4K | 1 | 350 |
| RE77N | NH100 | 75 | 1.0 to 14.7K | 1 | 385 |
| RE80G | RH250 | 120 | 0.10 to 35.7K | 1 | 630 |
| RE80N | NH250 | 120 | 1.0 to 17.4K | 1 | 690 |

TECHNICAL SPECIFICATIONS

| PARAMETER | UNIT | RE RESISTOR CHARACTERISTICS |
|-----------------------------|-----------------------|---|
| Temperature Coefficient | ppm/ $^\circ\text{C}$ | ± 20 for 10 Ω and above; ± 50 for 1 Ω to 9.9 Ω ; ± 100 for 0.1 Ω to 0.99 Ω |
| Maximum Working Voltage | V | $(P \times R)^{1/2}$ |
| Insulation Resistance | Ω | 10 000 M Ω minimum dry, 1000 M Ω minimum after moisture test |
| Solderability | - | MIL-PRF-18546 type - meets requirements of ANSI J-STD-002 |
| Operating Temperature Range | $^\circ\text{C}$ | -55 to +250 |

MILITARY PART NUMBER INFORMATION

Military Part Numbering example: RE77N1302J01

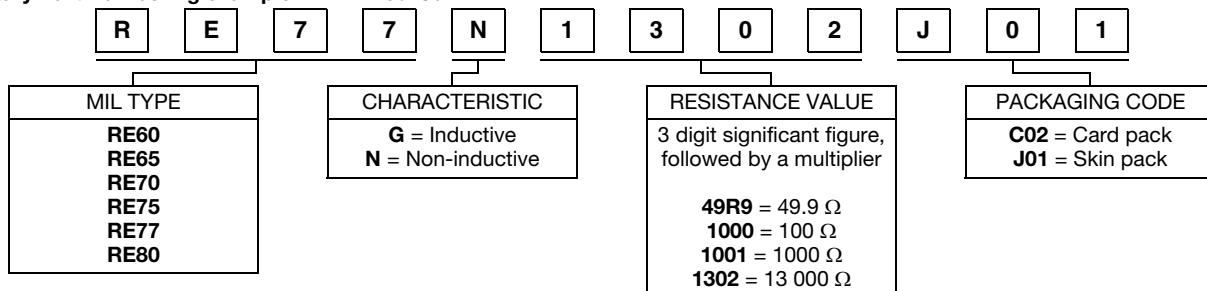
Note

- Only tolerance available for RE type is $\pm 1 \%$

DIMENSIONS in inches [millimeters]

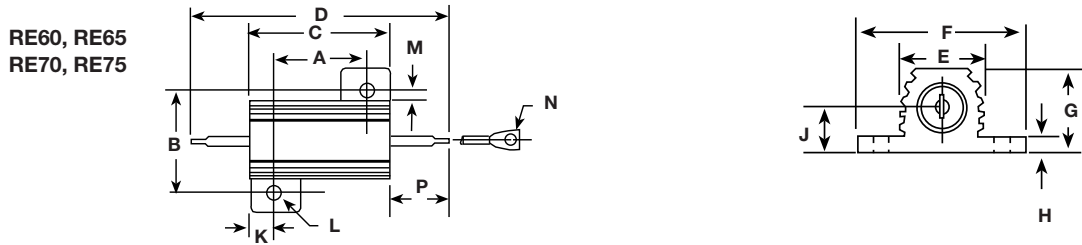

| MILITARY MODEL | DIMENSIONS in inches [millimeters] | | | | | | | | | | | | | |
|----------------|--|--|--|---------------------------------------|--|--|--|---------------------------------------|---------------------------------------|---------------------------------------|---------------------------------------|---------------------------------------|---------------------------------------|---------------------------------------|
| | A | B | C | D | E | F | G | H | J | K | L | M | N | P |
| RE60 | 0.444 ± 0.005 [11.28 ± 0.127] | 0.490 ± 0.005 [12.45 ± 0.127] | 0.600 ± 0.030 [15.24 ± 0.787] | 1.125 ± 0.062 [28.58 ± 1.57] | 0.334 ± 0.015 [8.48 ± 0.381] | 0.646 ± 0.015 [16.41 ± 0.381] | 0.320 ± 0.015 [8.13 ± 0.381] | 0.065 ± 0.010 [1.65 ± 0.254] | 0.133 ± 0.010 [3.38 ± 0.254] | 0.078 ± 0.010 [1.98 ± 0.254] | 0.093 ± 0.005 [2.36 ± 0.127] | 0.078 ± 0.015 [1.98 ± 0.381] | 0.050 ± 0.005 [1.27 ± 0.127] | 0.266 ± 0.062 [6.76 ± 1.57] |
| RE65 | 0.562 ± 0.005 [14.27 ± 0.127] | 0.625 ± 0.005 [15.88 ± 0.127] | 0.750 ± 0.031 [19.05 ± 0.787] | 1.375 ± 0.062 [34.93 ± 1.57] | 0.420 ± 0.015 [10.67 ± 0.381] | 0.800 ± 0.015 [20.32 ± 0.381] | 0.390 ± 0.015 [9.91 ± 0.381] | 0.075 ± 0.010 [1.91 ± 0.254] | 0.165 ± 0.010 [4.19 ± 0.254] | 0.093 ± 0.010 [2.36 ± 0.254] | 0.094 ± 0.005 [2.39 ± 0.127] | 0.102 ± 0.015 [2.59 ± 0.381] | 0.085 ± 0.005 [2.16 ± 0.127] | 0.312 ± 0.062 [7.92 ± 1.57] |
| RE70 | 0.719 ± 0.005 [18.26 ± 0.127] | 0.781 ± 0.005 [19.84 ± 0.127] | 1.062 ± 0.031 [26.97 ± 0.787] | 1.938 ± 0.062 [49.23 ± 1.57] | 0.550 ± 0.015 [13.97 ± 0.381] | 1.080 ± 0.015 [27.43 ± 0.381] | 0.546 ± 0.015 [13.87 ± 0.381] | 0.075 ± 0.010 [1.91 ± 0.254] | 0.231 ± 0.010 [5.87 ± 0.254] | 0.172 ± 0.010 [4.37 ± 0.254] | 0.125 ± 0.005 [3.18 ± 0.127] | 0.115 ± 0.015 [2.92 ± 0.381] | 0.085 ± 0.005 [2.16 ± 0.127] | 0.438 ± 0.062 [11.13 ± 1.57] |
| RE75 | 1.562 ± 0.005 [39.67 ± 0.127] | 0.844 ± 0.005 [21.44 ± 0.127] | 1.968 ± 0.031 [49.99 ± 0.787] | 2.781 ± 0.062 [70.64 ± 1.57] | 0.630 ± 0.015 [16.00 ± 0.381] | 1.140 ± 0.015 [28.96 ± 0.381] | 0.610 ± 0.015 [15.49 ± 0.381] | 0.088 ± 0.010 [2.24 ± 0.254] | 0.260 ± 0.010 [6.60 ± 0.254] | 0.196 ± 0.010 [4.98 ± 0.254] | 0.125 ± 0.005 [3.18 ± 0.127] | 0.107 ± 0.015 [2.72 ± 0.381] | 0.085 ± 0.005 [2.16 ± 0.127] | 0.438 ± 0.062 [11.13 ± 1.57] |

DIMENSIONS in inches [millimeters]

RE77

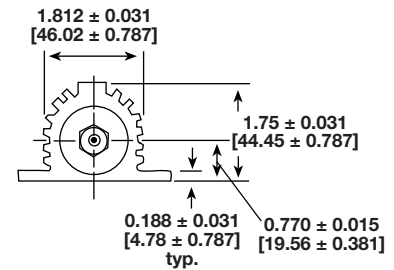
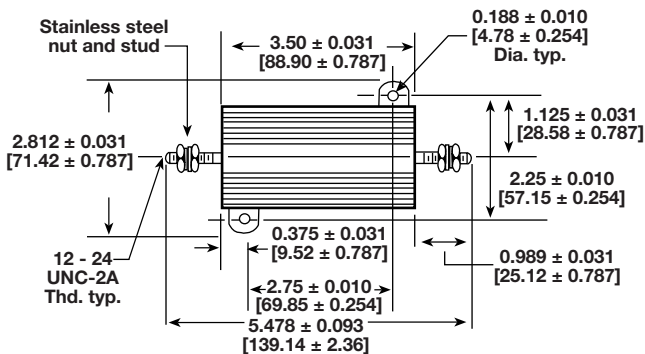

RE80

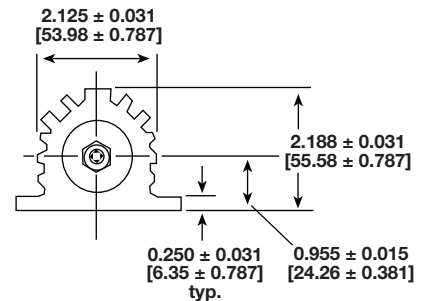
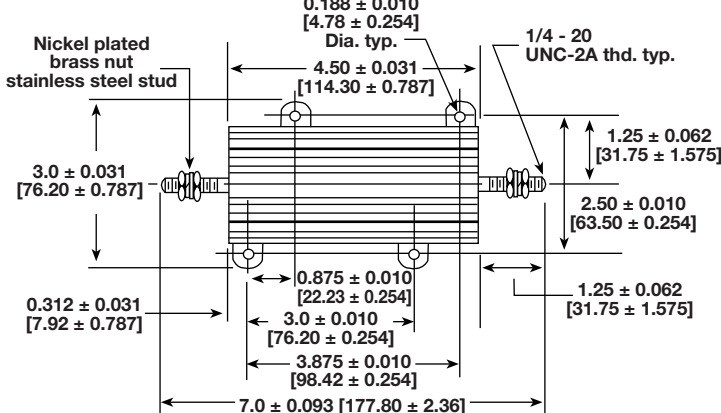



POWER RATING

Vishay RE resistor wattage ratings are based on mounting to the following heat sink:

- RE60 and RE65: 4" x 6" x 2" x 0.040" thick aluminum chassis
- RE70 and RE75: 5" x 7" x 2" x 0.040" thick aluminum chassis
- RE77 and RE80: 7" x 9" x 2" x 0.060" thick aluminum chassis

| FREE AIR POWER RATING | | | | | | |
|-----------------------|------|------|------|------|------|------|
| MILITARY MODEL | RE60 | RE65 | RE70 | RE75 | RE77 | RE80 |
| W at 25 °C | 3 | 6 | 8 | 10 | 30 | 75 |

AMBIENT TEMPERATURE DERATING

Derating is required for ambient temperatures above 25 °C when mounted to specified heat sink, see the following graph.



REDUCED HEAT SINK DERATING

Derating is also required when recommended heat sink area is reduced.





MATERIAL SPECIFICATIONS

Element: copper-nickel alloy or nickel-chrome alloy, depending on resistance value

Core: ceramic, steatite or alumina, depending on physical size

Encapsulant: silicone molded construction

Housing: aluminum with hard anodic coating

End Caps: stainless steel

Standard Terminals: For RE77 and RE80 terminals are threaded stainless steel. All others are 60/40 tin/lead (Sn/Pb) w/Nickel underplate on copper clad steel core terminal.

Part Marking: Dale, model, wattage, value, tolerance, date code

NON-INDUCTIVE (TYPE N)

Models of equivalent physical and electrical specifications are available with non-inductive (Ayrton-Perry) winding. They are identified by substituting the letter N for G in the model number (RE60N, for example).

| PERFORMANCE | | |
|---------------------------------|--|---------------------------------------|
| TEST | CONDITIONS OF TEST | TEST LIMITS |
| Thermal Shock | Rated power applied until thermally stable, then a minimum of 15 min at -55 °C | $\pm (0.5 \% + 0.05 \Omega) \Delta R$ |
| Short Time Overload | 5x rated power for 5 s | $\pm (0.5 \% + 0.05 \Omega) \Delta R$ |
| Dielectric Withstanding Voltage | 1000 V _{RMS} for RE60, RE65 and RE70; 2000 V _{RMS} for RE75; 4500 V _{RMS} for RE77 and RE80; duration 1 min | $\pm (0.2 \% + 0.05 \Omega) \Delta R$ |
| Temperature | 250 °C for 2 h | $\pm (0.5 \% + 0.05 \Omega) \Delta R$ |
| Moisture Resistance | MIL-STD-202 Method 106, 7b not applicable | $\pm (1.0 \% + 0.05 \Omega) \Delta R$ |
| Shock, Specified Pulse | MIL-STD-202 Method 213, 100 g's for 6 ms, 10 shocks | $\pm (0.2 \% + 0.05 \Omega) \Delta R$ |
| Vibration, High Frequency | Frequency varied 10 Hz to 2000 Hz, 20 g peak, 2 directions 6 h each | $\pm (0.2 \% + 0.05 \Omega) \Delta R$ |
| Load Life | 1000 h at rated power, +25 °C, 1.5 h "ON", 0.5 h "OFF" | $\pm (1.0 \% + 0.05 \Omega) \Delta R$ |
| Terminal Strength | 30 s, 5 pound pull test for RE60 and RE65, 10 pound pull test for other sizes; torque test - 24 pound inch for RE77 and 32 pound inch for RE80 | $\pm (0.2 \% + 0.05 \Omega) \Delta R$ |



Disclaimer

ALL PRODUCT, PRODUCT SPECIFICATIONS AND DATA ARE SUBJECT TO CHANGE WITHOUT NOTICE TO IMPROVE RELIABILITY, FUNCTION OR DESIGN OR OTHERWISE.

Vishay Intertechnology, Inc., its affiliates, agents, and employees, and all persons acting on its or their behalf (collectively, "Vishay"), disclaim any and all liability for any errors, inaccuracies or incompleteness contained in any datasheet or in any other disclosure relating to any product.

Vishay makes no warranty, representation or guarantee regarding the suitability of the products for any particular purpose or the continuing production of any product. To the maximum extent permitted by applicable law, Vishay disclaims (i) any and all liability arising out of the application or use of any product, (ii) any and all liability, including without limitation special, consequential or incidental damages, and (iii) any and all implied warranties, including warranties of fitness for particular purpose, non-infringement and merchantability.

Statements regarding the suitability of products for certain types of applications are based on Vishay's knowledge of typical requirements that are often placed on Vishay products in generic applications. Such statements are not binding statements about the suitability of products for a particular application. It is the customer's responsibility to validate that a particular product with the properties described in the product specification is suitable for use in a particular application. Parameters provided in datasheets and / or specifications may vary in different applications and performance may vary over time. All operating parameters, including typical parameters, must be validated for each customer application by the customer's technical experts. Product specifications do not expand or otherwise modify Vishay's terms and conditions of purchase, including but not limited to the warranty expressed therein.

Except as expressly indicated in writing, Vishay products are not designed for use in medical, life-saving, or life-sustaining applications or for any other application in which the failure of the Vishay product could result in personal injury or death. Customers using or selling Vishay products not expressly indicated for use in such applications do so at their own risk. Please contact authorized Vishay personnel to obtain written terms and conditions regarding products designed for such applications.

No license, express or implied, by estoppel or otherwise, to any intellectual property rights is granted by this document or by any conduct of Vishay. Product names and markings noted herein may be trademarks of their respective owners.

X-ON Electronics

Largest Supplier of Electrical and Electronic Components

Click to view similar products for [Other Tools](#) category:

Click to view products by [Vishay](#) manufacturer:

Other Similar products are found below :

[CR-05FL7--150R](#) [CR-05FL7--698K](#) [899-2-KT46](#) [899-5-KT46](#) [CR-0AFL4--332K](#) [CR-12FP4--260R](#) [CRCW04021100FRT7](#)
[CRCW04021961FRT7](#) [5800-0090](#) [CRCW04024021FRT7](#) [CRCW040254R9FRT7](#) [CRCW0603102JRT5](#) [59065-5](#) [00-8273-RDPP](#) [00-8729-](#)
[WHPP](#) [593033](#) [593058](#) [593072](#) [593564100](#) [593575](#) [593591](#) [593593](#) [011349-000](#) [CRCW08052740FRT1](#) [LUC-012S070DSM](#) [LUC-](#)
[018S070DSP](#) [599-2021-3-NME](#) [599-JJ-2021-03](#) [00-5080-YWPP](#) [5E4750/01-20R0-T/R](#) [LW1A-L1-GL](#) [LW1A-P1-GD](#) [LW1L-A1C10V-GL](#)
[LW1L-M1C70-A](#) [0202-0173](#) [00-9089-RDPP](#) [00-9300-RDPP](#) [CRCW2010331JR02](#) [01-1003W-8/32-10](#) [601-GP-08-KT39](#) [601-JJ-06](#) [601-SPB](#)
[601YSY](#) [602-JJ-03](#) [602SPB](#) [602Z](#) [603-JJ-07-FP](#) [603-JJY-04](#) [604J](#) [604-JJ-05](#)