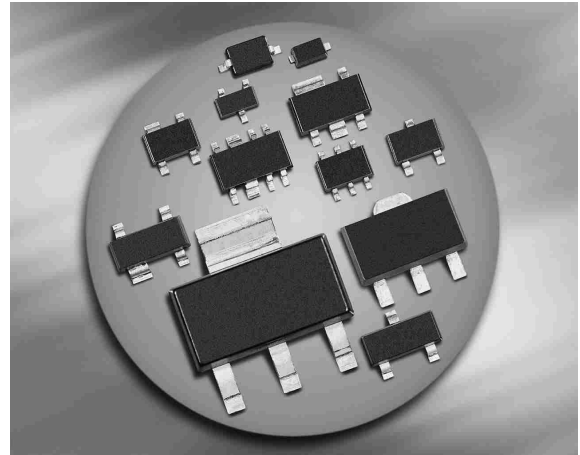
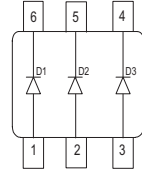
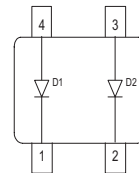
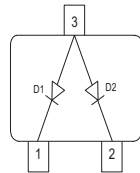
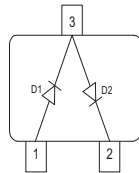
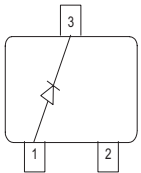

**Silicon Schottky Diodes**

- For mixer applications in the VHF / UHF range
- For high-speed switching applications
- Pb-free (RoHS compliant) package

**BAT68**
**BAT68-04**  
**BAT68-04W**
**BAT68-06**  
**BAT68-06W**
**BAT68-07W**
**BAT68-08S**

**ESD (Electrostatic discharge) sensitive device, observe handling precaution!**

Type	Package	Configuration	$L_S$ (nH)	Marking
BAT68	SOT23	single	1.8	83s
BAT68-04	SOT23	series	1.8	84s
BAT68-04W	SOT323	series	1.4	84s
BAT68-06	SOT23	common anode	1.8	86s
BAT68-06W	SOT323	common anode	1.4	86s
BAT68-07W	SOT343	parallel pair	1.6	87s
BAT68-08S	SOT363	parallel triple	1.4	83s

**Maximum Ratings** at  $T_A = 25^\circ\text{C}$ , unless otherwise specified

Parameter	Symbol	Value	Unit
Diode reverse voltage	$V_R$	8	V
Forward current	$I_F$	130	mA
Total power dissipation BAT68, $T_S \leq 77^\circ\text{C}$ BAT68-04, BAT68-06, $T_S \leq 61^\circ\text{C}$ BAT68-04W/-06W/-08S, $T_S \leq 92^\circ\text{C}$ BAT68-07W, $T_S \leq 89^\circ\text{C}$	$P_{\text{tot}}$	150 150 150 150	mW
Junction temperature	$T_j$	150	°C
Storage temperature	$T_{\text{stg}}$	-55 ... 150	

**Thermal Resistance**

Parameter	Symbol	Value	Unit
Junction - soldering point <sup>1)</sup> BAT68 BAT68-04, BAT68-06 BAT68-04W-BAT68-06W, BAT68-08S BAT68-07W	$R_{\text{thJS}}$	$\leq 490$ $\leq 590$ $\leq 390$ $\leq 410$	K/W

**Electrical Characteristics** at  $T_A = 25^\circ\text{C}$ , unless otherwise specified

Parameter	Symbol	Values			Unit
		min.	typ.	max.	
Breakdown voltage $I_{(\text{BR})} = 10 \mu\text{A}$	$V_{(\text{BR})}$	8	-	-	V
Reverse current $V_R = 1 \text{ V}$ $V_R = 1 \text{ V}, T_A = 60^\circ\text{C}$	$I_R$	- -	- -	0.1 1.2	$\mu\text{A}$
Forward voltage $I_F = 1 \text{ mA}$ $I_F = 10 \text{ mA}$	$V_F$	- 340	318 390	340 500	mV

<sup>1)</sup>For calculation of  $R_{\text{thJA}}$  please refer to Application Note Thermal Resistance

**Electrical Characteristics** at  $T_A = 25^\circ\text{C}$ , unless otherwise specified

Parameter	Symbol	Values			Unit
		min.	typ.	max.	
<b>AC Characteristics</b>					
Diode capacitance $V_R = 0, f = 1 \text{ MHz}$	$C_T$	-	-	1	pF
Differential forward resistance $I_F = 5 \text{ mA}, f = 10 \text{ kHz}$	$R_F$	-	-	10	$\Omega$

**Diode capacitance  $C_T = f(V_R)$**

$f = 1\text{MHz}$

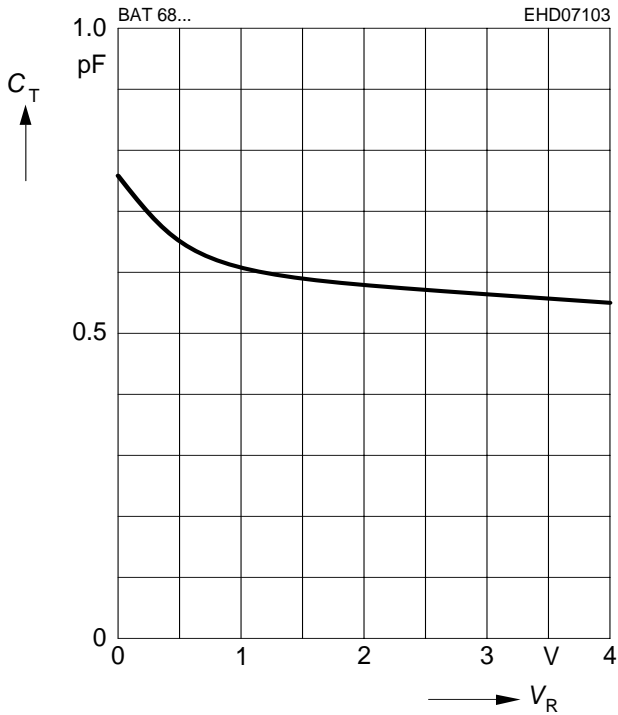

**Differential forward resistance  $r_f = f(I_F)$**

$f = 10\text{kHz}$

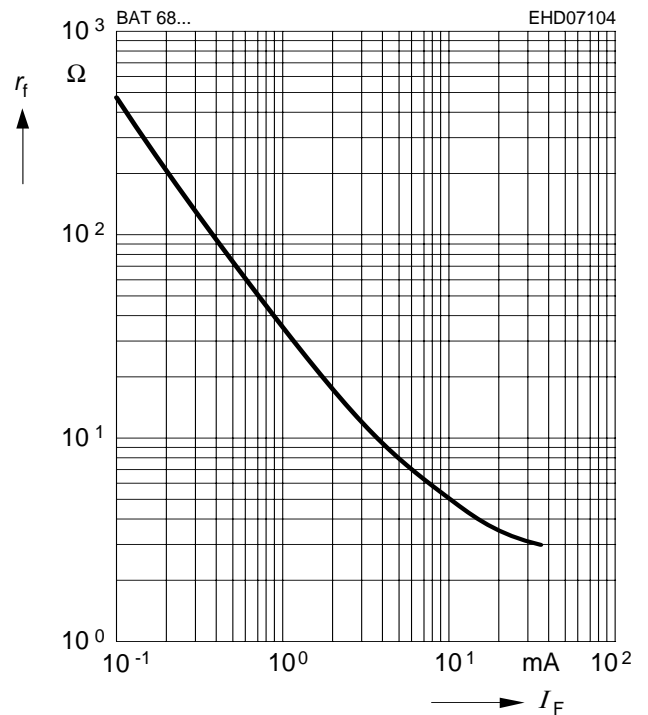

**Reverse current  $I_R = f(V_R)$**

$T_A = \text{Parameter}$

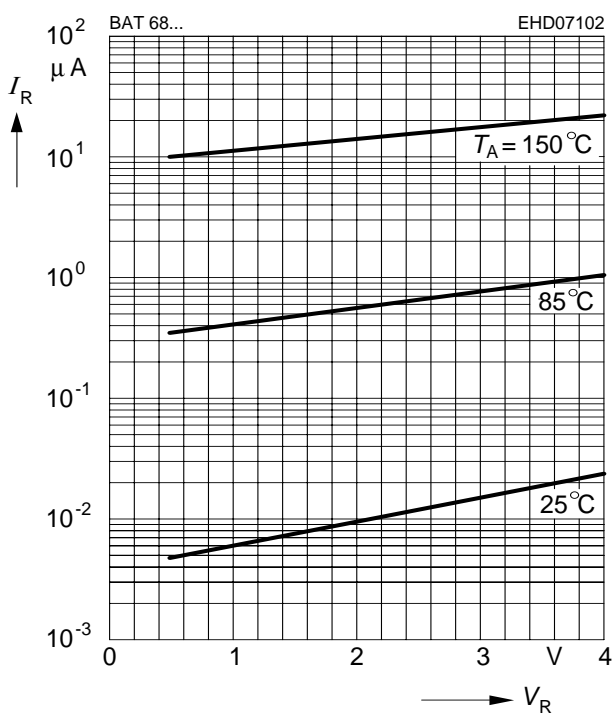

**Forward current  $I_F = f(V_F)$**

$T_A = \text{Parameter}$

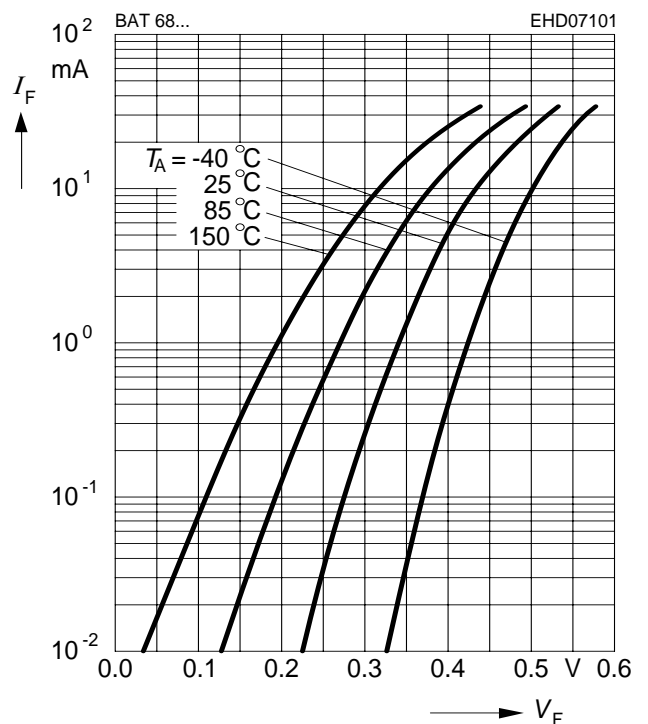

**Forward current  $I_F = f(T_S)$**

BAT68

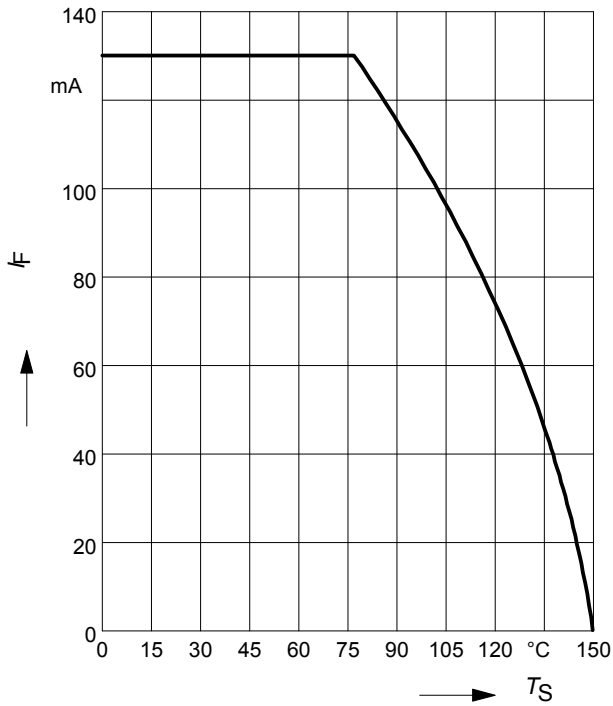

**Forward current  $I_F = f(T_S)$**

BAT68-04, BAT68-06

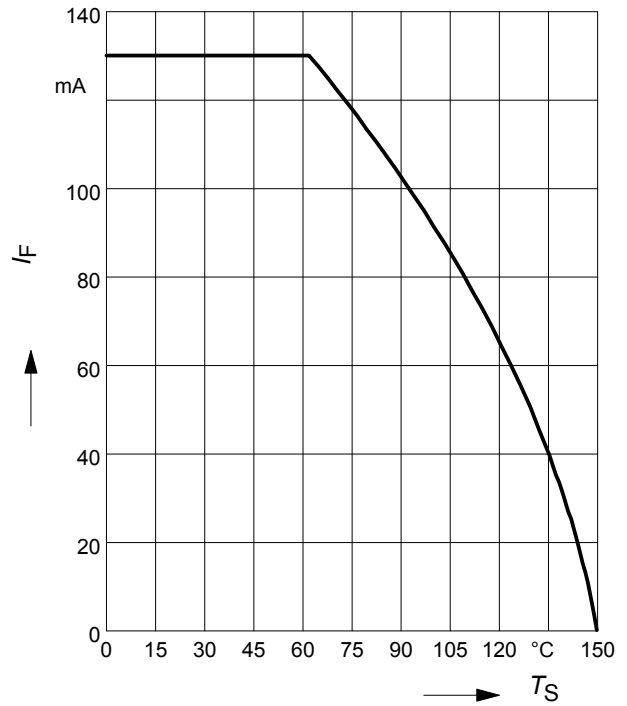

**Forward current  $I_F = f(T_S)$**

BAT68-04W, BAT68-06W, BAT68-08S

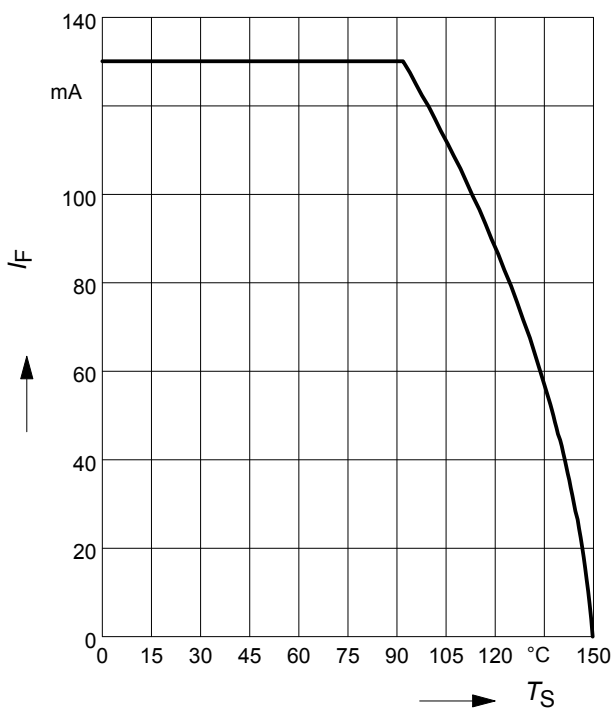

**Forward current  $I_F = f(T_S)$**

BAT68-07W

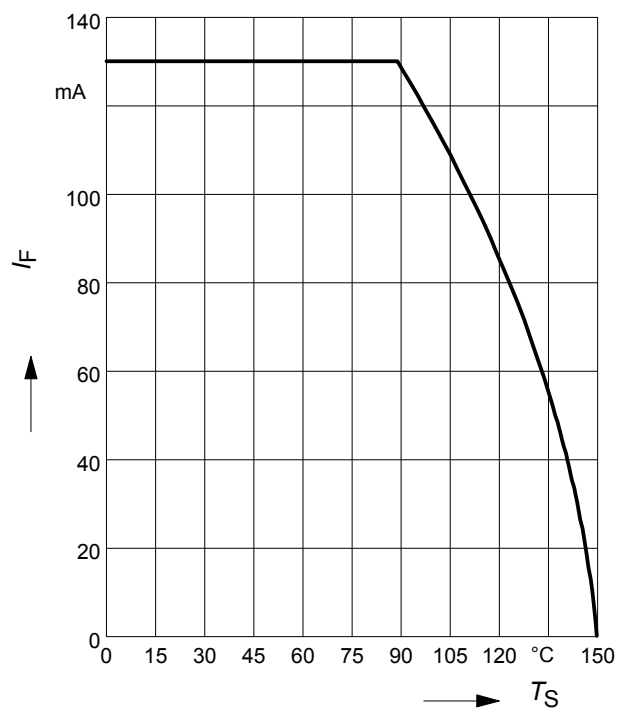

**Permissible Puls Load  $R_{thJS} = f(t_p)$**

BAT68-04W, BAT68-06W

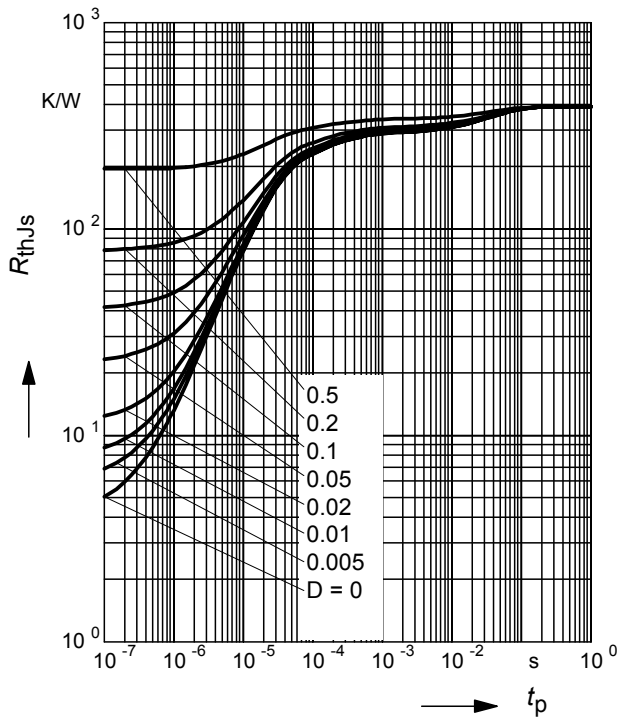

**Permissible Pulse Load**

$I_{Fmax} / I_{FDC} = f(t_p)$

BAT68-04W, BAT68-06W

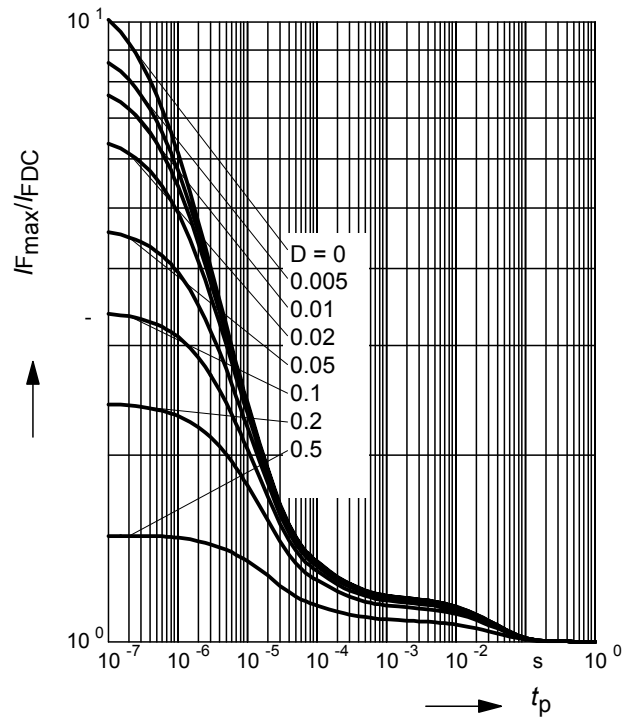

**Permissible Puls Load  $R_{thJS} = f(t_p)$**

BAT68-07W

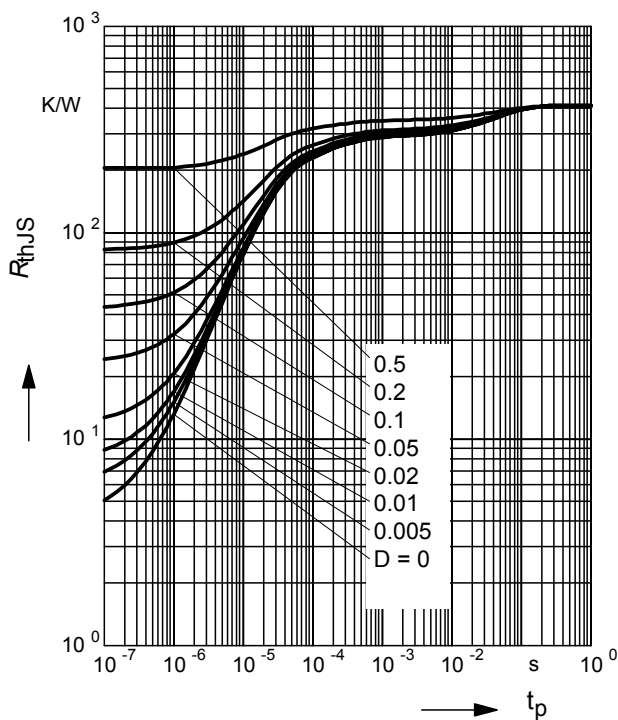

**Permissible Pulse Load**

$I_{Fmax} / I_{FDC} = f(t_p)$

BAT68-07W

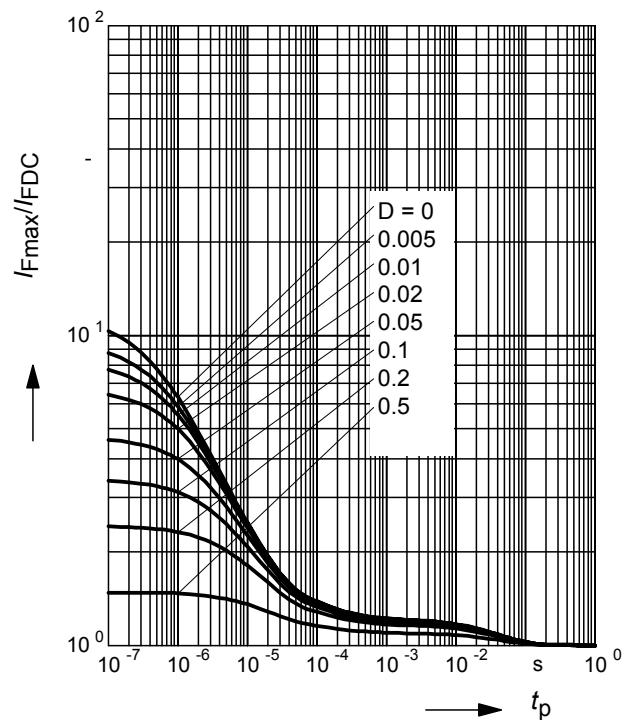

Rectifier voltage  $V_{out} = f(V_{in})$

$f = 900\text{MHz}$

$R_L =$  Parameter in  $k\Omega$

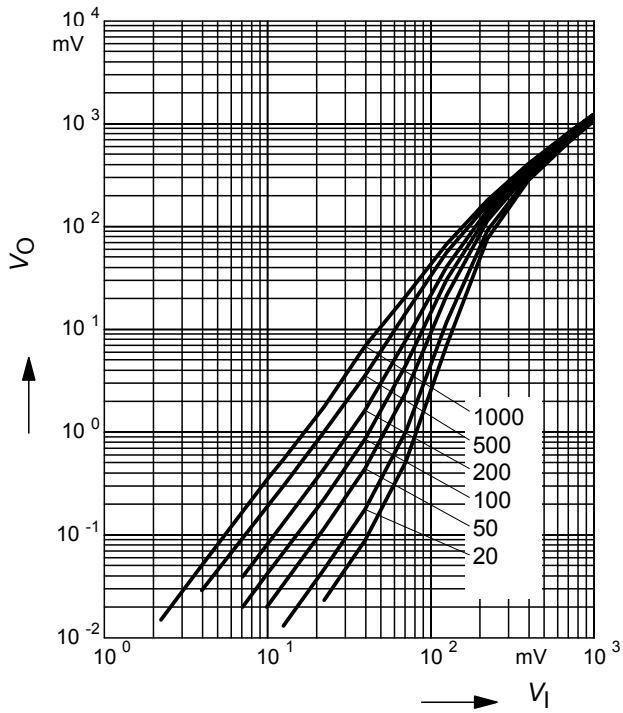

Testcircuit

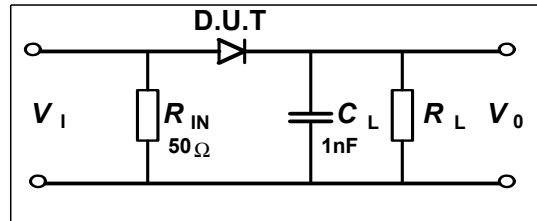

Package Outline



1) Lead width can be 0.6 max. in dambar area

Foot Print



Marking Layout (Example)



Standard Packing

Reel  $\varnothing$ 180 mm = 3.000 Pieces/Reel  
 Reel  $\varnothing$ 330 mm = 10.000 Pieces/Reel

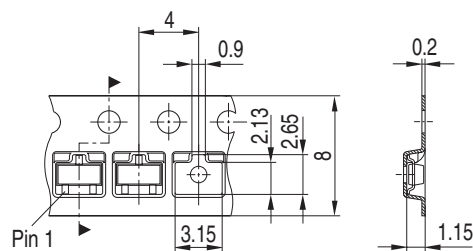



Package Outline



Foot Print



Marking Layout (Example)



Standard Packing

Reel  $\varnothing$ 180 mm = 3.000 Pieces/Reel  
 Reel  $\varnothing$ 330 mm = 10.000 Pieces/Reel



Package Outline

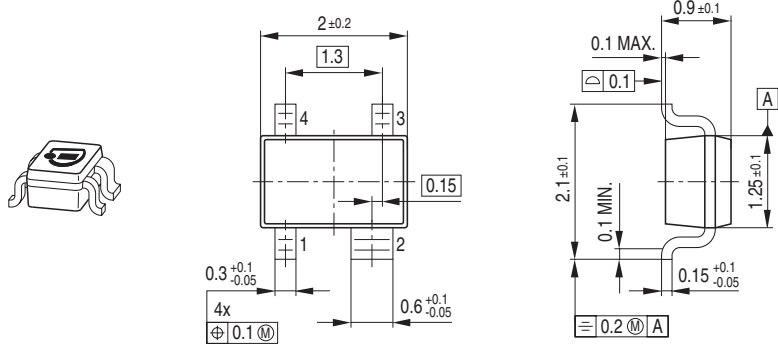

Foot Print

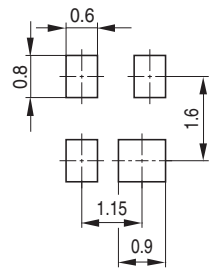

Marking Layout (Example)

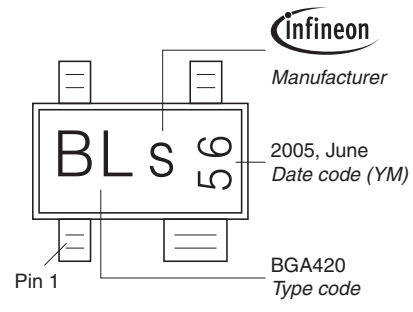

Standard Packing

Reel ø180 mm = 3.000 Pieces/Reel  
 Reel ø330 mm = 10.000 Pieces/Reel

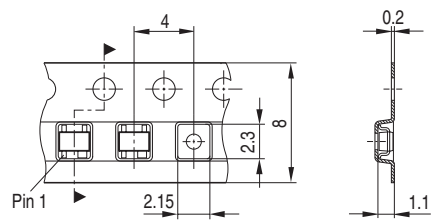

Package Outline



Foot Print



Marking Layout (Example)

Small variations in positioning of Date code, Type code and Manufacture are possible.

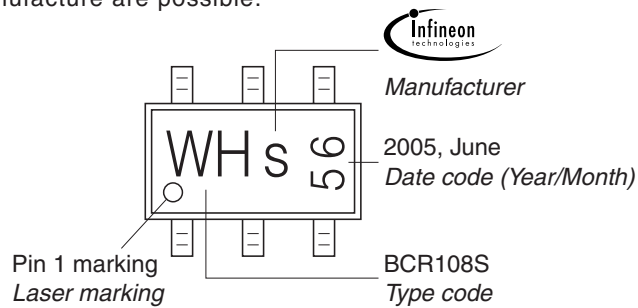

Standard Packing

Reel  $\varnothing$ 180 mm = 3.000 Pieces/Reel  
 Reel  $\varnothing$ 330 mm = 10.000 Pieces/Reel

For symmetric types no defined Pin 1 orientation in reel.

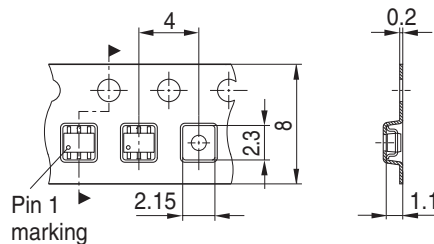

**Edition 2009-11-16**

**Published by  
Infineon Technologies AG  
81726 Munich, Germany**

**© 2009 Infineon Technologies AG  
All Rights Reserved.**

### **Legal Disclaimer**

The information given in this document shall in no event be regarded as a guarantee of conditions or characteristics. With respect to any examples or hints given herein, any typical values stated herein and/or any information regarding the application of the device, Infineon Technologies hereby disclaims any and all warranties and liabilities of any kind, including without limitation, warranties of non-infringement of intellectual property rights of any third party.

### **Information**

For further information on technology, delivery terms and conditions and prices, please contact the nearest Infineon Technologies Office ([<www.infineon.com>](http://www.infineon.com)).

### **Warnings**

Due to technical requirements, components may contain dangerous substances. For information on the types in question, please contact the nearest Infineon Technologies Office.

Infineon Technologies components may be used in life-support devices or systems only with the express written approval of Infineon Technologies, if a failure of such components can reasonably be expected to cause the failure of that life-support device or system or to affect the safety or effectiveness of that device or system. Life support devices or systems are intended to be implanted in the human body or to support and/or maintain and sustain and/or protect human life. If they fail, it is reasonable to assume that the health of the user or other persons may be endangered.

## X-ON Electronics

Largest Supplier of Electrical and Electronic Components

*Click to view similar products for [infineon](#) manufacturer:*

Other Similar products are found below :

[TDA5250](#) [SPA07N60CFD](#) [TLE6209R](#) [IDB06S60C](#) [EVALLEDILD6150TOBO1](#) [EVALM113023645ATOBO1](#) [EVALM11302TOBO1](#)  
[FD1000R33HE3-K](#) [FD300R06KE3](#) [FF1200R17KE3\\_B2](#) [FF300R06KE3HOSA1](#) [FF600R12ME4P](#) [FF600R17ME4\\_B11](#) [FP25R12KT4](#)  
[FP25R12KT4\\_B11](#) [FS600R07A2E3\\_B31](#) [FZ1600R17HP4\\_B2](#) [FZ1800R17KF4](#) [FZ2400R17HE4\\_B9](#) [FZ600R65KE3](#) [DD1200S17H4\\_B2](#)  
[DD261N22K](#) [DF1000R17IE4](#) [BAT 165 E6327](#) [BCR 141W H6327](#) [BCR 162 E6327](#) [BCR402U](#) [BCR 555 E6327](#) [BCW 60C E6327](#)  
[BDP950H6327XTSA1](#) [BFN 27 E6327](#) [BSM50GB60DLC](#) [BSO080P03NS3EGXUMA](#) [BSR802NL6327HTSA1](#) [BTF3050TE](#)  
[BTM7811KAUMA1](#) [IPD50N04S4-08](#) [IRPLHID2A](#) [ISP772TFUMA1](#) [KIT\\_TC1791\\_SK](#) [KIT\\_XMC45\\_AE4\\_002](#) [KIT\\_XMC4x\\_COM\\_ETH-](#)  
[001](#) [EVALM113020584DTOBO1](#) [FF1400R12IP4](#) [FF300R17KE3\\_S4](#) [FF450R12ME4\\_B11](#) [T1401N42TOH](#) [T1500N16TOF](#) [VT](#)  
[T1851N60TOH](#) [T901N36TOF](#)